

Included Components

- Hardware Pack and Mounting Instructions (Not Shown)
- Wired Canopy with Cables
- Axis Hex Wired Body with Shrouds installed
- Axis Glass (6pcs)
- Adhesive Labels

Required Tools

- Philips screw driver (not provided)
- Cable Cutter (to cut excess cable off after mounting to desired height)
- Measuring tape (not provided)

Special Notes

- TWO PEOPLE ARE RECOMMENDED FOR INSTALLATION OF THIS FIXTURE TO ENSURE STABILIZATION DURING GLASS AND SHROUD INSTALLATION**

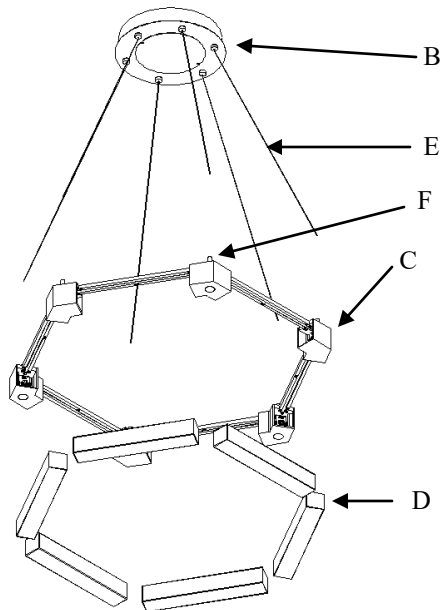

CHB0060-35

Assembly

Step 1: Remove Canopy cover plate from the faceplate by removing two 4-40 flat head screws using Phillips head screw driver. Mount Canopy (B) to ceiling using the appropriate Hardware Packet (A) and included instructions.

HARDWARE PACKET Z: MOUNTS TO BUILDING

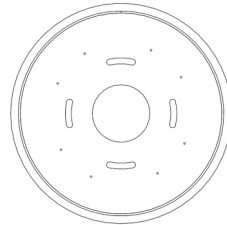

Step 2: Cables (E) and Cable Grippers (F) are marked by a numbered tag. Each Cable (E) will be inserted into the Cable Gripper (F) marked with the same number.

Step 3: After locating the corresponding Cable (E) and Cable gripper (F), unscrew the Cable Gripper Cap (Fi). Thread the Cable (E) through the Cap (Fi) and into the Gripper Body (Fii). Adjust fixture height by pushing or pulling Cable through Gripper Body while depressing threaded plunger at top of Gripper.

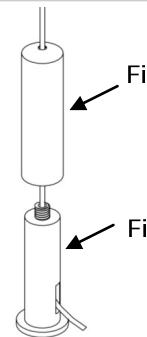

CAUTION: CABLES ARE CONDUCTIVE. DO NOT POWER FIXTURE WHILE CABLES ARE IN CONTACT WITH ANY CONDUCTIVE SURFACE. THIS INCLUDES HAVING THE CABLE PROTRUDE THROUGH THE GRIPPER AND TOUCH THE BODY OF THE LIGHT FIXTURE.

Step 4: Use a measuring tape and level to ensure the fixture is hanging at the desired distance from the Canopy. When desired height is attained cut excess Cable flush with Gripper Body. Thread Cable Gripper Cap back onto Body.

Step 5: Make Electrical Connections from the building to the Drivers inside of Canopy using the wire nuts provided. Replace Cover plate.

Glass Install Instructions

CAUTION: INSTALL GLASS IN ORDER SHOWN, TO HELP KEEP FIXTURE BALANCED SO GLASS DOES NOT FALL OUT DURING INSTALLATION.

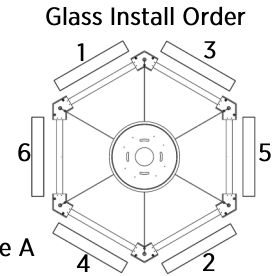
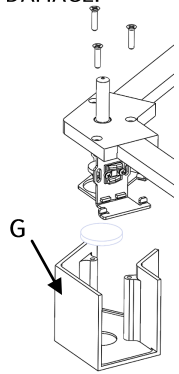

Figure A

CAUTION: USE SUPPLIED ADHESIVE LABELS (H) TO SECURE GLASS TO FIXTURE BODY DURING INSTALLATION. FAILURE TO USE LABELS PROPERLY MAY RESULT IN SERIOUS PERSONAL INJURY OR DEATH AND PROPERTY DAMAGE.

Step 6: Using Phillips head screw driver, remove the six (6) corner shrouds (G) from hanging body assembly. Set aside. Note: Three (3) of the corners have downlights and acrylic diffusers, while the



Step 7: Locate Axis Glass (D) and orient so the seam is position on the top and bottom. This is how the glass will be installed on the fixture.

Step 8: Install Axis Glass one piece at a time, following the Glass Install Order shown above in Figure A. Install by sliding glass into place from the side as shown. Center the glass and apply two (2) Adhesive Labels (H) to

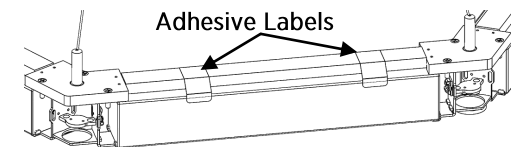

Step 9: Install Acrylic Diffuser into three shrouds with downlight holes. Install Shrouds to Body from the bottom, using same screws that were removed in Step 6. Take care to install Downlight Corner Shrouds on the three corners wired with Downlight LEDs. Take care that Acrylic Diffuser is seated properly during and after shroud installation. Remove Adhesive Labels when com-

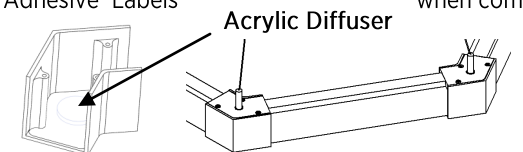

About Hammerton Studio

HAMMERTON STUDIO

In 2013, the Hammerton Studio brand was created to offer artisan-crafted, contemporary design solutions that are both versatile and accessible. Hammerton Studio fixtures add contemporary distinction to entries, great rooms and master suites, yet are cost-effective enough to use throughout any residential or commercial projects. Like all Hammerton fixtures, they are designed and fabricated in Salt Lake City, Utah using domestically sourced materials.

POWERFUL DESIGN

Since 1992, Hammerton has been known for extraordinary decorative lighting that is boldly designed, expertly rendered, perfectly proportioned and exquisitely detailed. Each fixture exudes a design aesthetic that is timeless and enduring, yet remarkably relevant.

UNCOMPROMISING CRAFTSMANSHIP

In addition to their exceptional metalworking and finishing expertise, Hammerton artisans share an aesthetic eye and a sculptural talent that define the difference between ordinary and extraordinary craftsmanship. Every fixture demonstrates its artisan's ability to elevate craft to an art form.

UNIQUE MATERIALS

Our heritage is in metal fabrication, but our passion is design. As a result—and unlike most of our peers—we work in a broad palette of materials: steel and aluminum, blown, kiln-fired and lampworked glass, acrylics, mica, stone, rawhide, woods and much more. Seamless integration of these capabilities is the "secret sauce" that drives our industry leadership as the premier U.S. based custom lighting manufacturer.

A REPUTATION REFLECTED BY OUR CLIENTS

Hammerton fixtures are as extraordinary as the clients who purchase them, including Forbes 400 members, Fortune 500 leaders, award-winning entertainers, fashion and interior designers, sports legends, and leading luxury hospitality brands.

Hammerton
217 Wright Brothers Drive
Salt Lake City, UT
84116

801-973-8095
info@hammerton.com
www.hammerton.com

Warranty

ONE YEAR LIMITED WARRANTY

Hammerton, Inc. (Hammerton) warrants the original owner that this product will be free of defects in material or workmanship for the period of one year from the date of original purchase from Hammerton, if (i) the allegedly defective product has not been abused, misused or improperly maintained and or repaired during the warranty period, (ii) the defect is not caused by water damage/flooding, fire, explosion, earthquakes or similar phenomenon, and (iii) the defect is not caused by improper installation (unless installed by Hammerton). In order to obtain warranty service, the user must first complete a warranty claims form. Hammerton will determine if the product will be inspected on site or returned to Hammerton. If after the inspection Hammerton finds that the product is defective as claimed, Hammerton will, at its option, repair or replace the product free of charge, or Hammerton may in its sole discretion, refund the purchase price. Hammerton warrants any replaced or repaired products for ninety days after shipment or through the end of the original warranty period, whichever is longer. All products or parts that are replaced become the property of Hammerton. No representative or employee of Hammerton is authorized to make any modification or addition to this limited warranty.

TO THE FULL EXTENT ALLOWED BY LAW, THE FOREGOING WARRANTY AND REMEDIES ARE EXCLUSIVE, AND HAMMERTON EXPRESSLY DISCLAIMS ALL OTHER WARRANTIES, EXPRESSED OR IMPLIED, INCLUDING WITHOUT LIMITATION THE IMPLIED WARRANTIES OF MERCHANTABILITY AND FITNESS FOR A PARTICULAR PURPOSE. TO THE FULL EXTENT ALLOWED BY LAW, HAMMERTON EXCLUDES AND DISCLAIMS LIABILITY, WHETHER BASED IN CONTRACT OR TORT (INCLUDING NEGLIGENCE FOR ANY CONSEQUENTIAL, INDIRECT INCIDENTAL OR SPECIAL DAMAGES OF ANY NATURE ARISING OUT OF THE SALE INSTALLATION, MAINTENANCE, USE OR FAILURE OF THIS PRODUCT, EVEN IF HAMMERTON HAS BEEN ADVISED OF THE POSSIBILITY OF SUCH DAMAGES IN ADVANCE, AND HAMMERTON LIMITS ITS LIABILITY TO REPLACEMENT, REPAIR OR REFUND OF THE PURCHASE PRICE PAID, AT HAMMERTON'S OPTION.) SOME STATES DO NOT ALLOW LIMITATIONS ON HOW LONG AN IMPLIED WARRANTY LASTS AND/OR DO NOT ALLOW THE EXCLUSION OR LIMITATION OF INCIDENTAL OR CONSEQUENTIAL DAMAGES, SO THE ABOVE LIMITATION ON IMPLIED WARRANTY AND INCIDENTAL OR CONSEQUENTIAL DAMAGES MAY NOT APPLY TO YOU. THIS WARRANTY GIVES YOU SPECIFIC LEGAL RIGHTS YOU MAY HAVE OTHER RIGHTS, WHICH VARY FROM STATE TO STATE

HAMMERTONSTUDIO™

Assembly Instructions

Axis Ring Chandelier

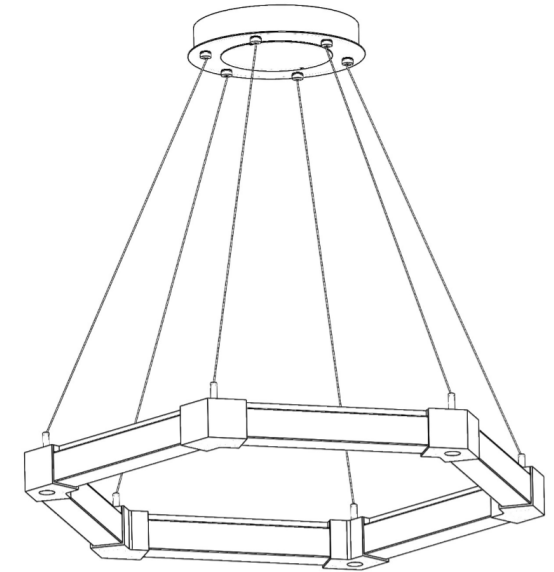

CHB0060-35

WARNING: FAILURE TO INSTALL THIS FIXTURE PROPERLY MAY RESULT IN SERIOUS PERSONAL INJURY OR DEATH AND PROPERTY DAMAGE.

It is recommended that this product be installed by a licensed electrician.

Rev 2
41-001-00116