

### Technical information:

Light source: CAUTION: TO REDUCE THE RISK OF FIRE, USE MAX. 40 WATT INCANDESCENT, E12, type b bulb, 120V 60Hz AC ONLY. Alternatively max. 30W halogen bulb.  
Turn power off when changing light bulb.  
The lamp is not approved for outdoor use or use in damp/wet rooms.

### Some advice on cleaning your BestLite:

#### Powder coated parts – base/bracket and shade:

Wipe the parts with a damp cloth soaked in warm water and a bit of mild detergent.

#### Chrome plated parts:

Wipe the lamp with a damp cloth and wipe dry to bring up lustre.  
If the surface is sticky use a metal polish made especially for chromium or other soft metals.

Use only soft cloth for wiping and polishing, never sponges or steel wool.

Do not use abrasive household cleaners.

Do not use acidic or alkaline cleaning materials, glass cleaner or household ammonia.

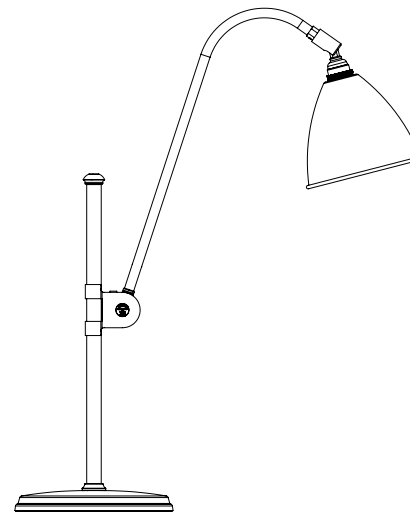

Dear BestLite customer,

Congratulations on your BestLite!

You have chosen a genuine design classic, which has been in continuous production for more than 75 years.

On the other side of this leaflet you will find some useful instructions for the use of your BestLite.

Should you have any questions, please feel free to e-mail us at [gubi@gubi.com](mailto:gubi@gubi.com) or visit us at [www.gubi.com](http://www.gubi.com).

Best regards,  
BestLite

001-013xx

# BESTLITE

— BY GUBI —

