

Contemporary Lighting

PRODUCT NAME: Quartz

ITEM NUMBER: E31242-20

Please consult your electrician for hanging fixture and wiring.

The fixture is designed to with a standard Triac forward phase dimmer. Dimming levels will vary by dimmer.

Below is a list of recommended dimmers:

Lutron MACL-153M

Lutron DVL-153P

Lutron SCL-153P

Leviton IPL06-10Z

Leviton 6674-POW

Due to inrush current wattage should not exceed 150 watts of product for a 600 watt dimmer.

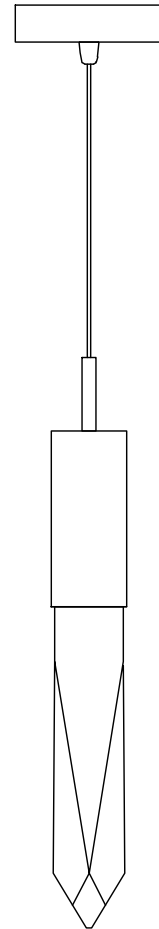

AC LED 1 x 6W Bulb

MADE IN CHINA

Page 1 of (2)

IMPORTANT: Turn off the power at the main fuse or circuit breaker box before starting installation

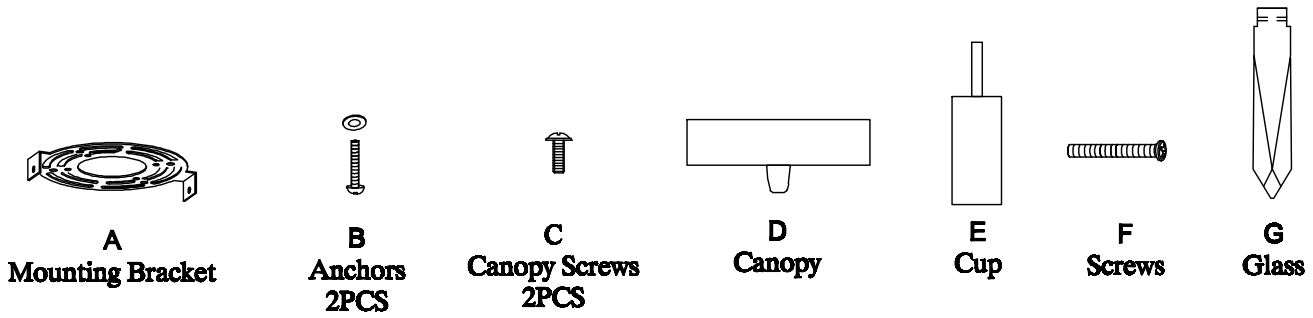

Locate all hardware & components before discarding packaging

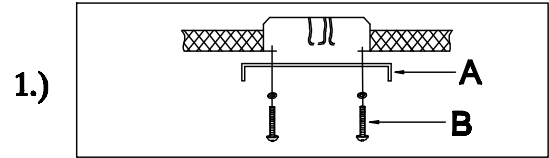
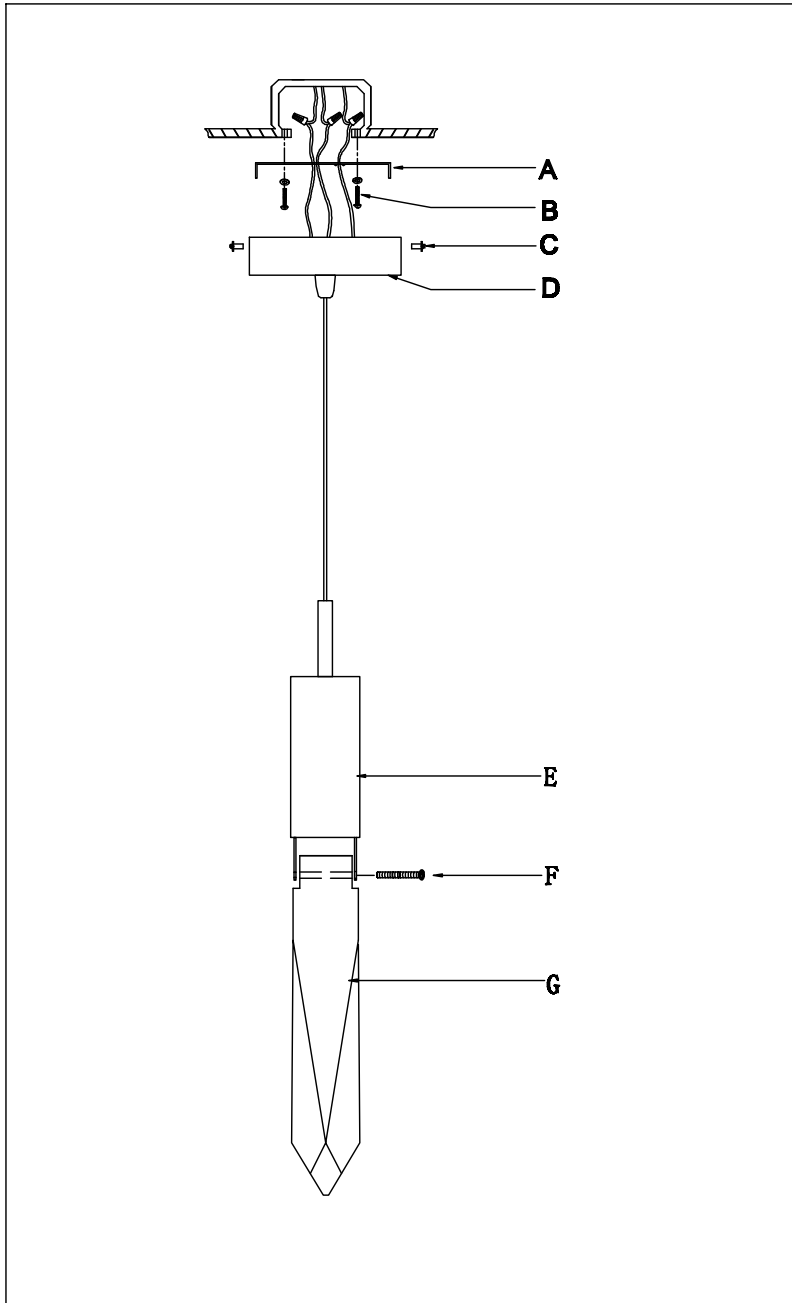

1.)
Step 1: Remove mounting bracket (A) from Canopy (D) and install bracket (A) to electrical box by attaching anchors (B).

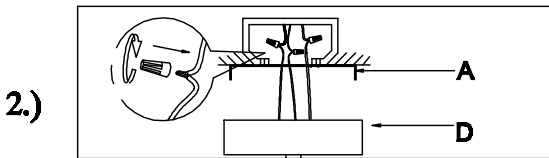

2.)
Step 2: Wire fixture to wires in outlet box. Copper wire is for Ground.

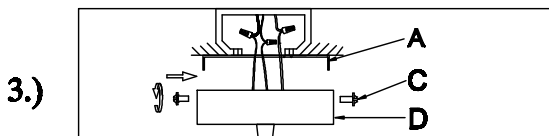

3.)
Step 3: Carefully remove packaging from fixture, Adjust wire length to desired mounting height, Install canopy (D) to bracket using canopy screws (C) on the bottom of the canopy.

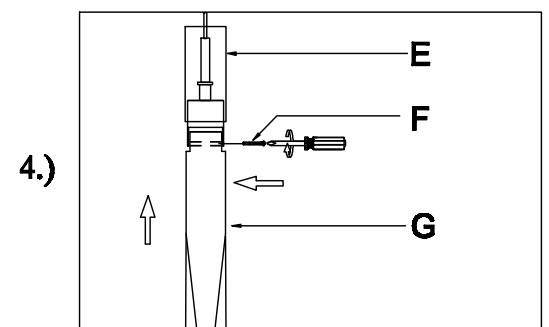

4.)
Step 4: Attach glass (G) using set screws (F).

Cleaning & Care:

Clean with soft cloth and a mild detergent.
Do not use abrasive cleaner.