

AARO ceiling

by Simon Schmitz

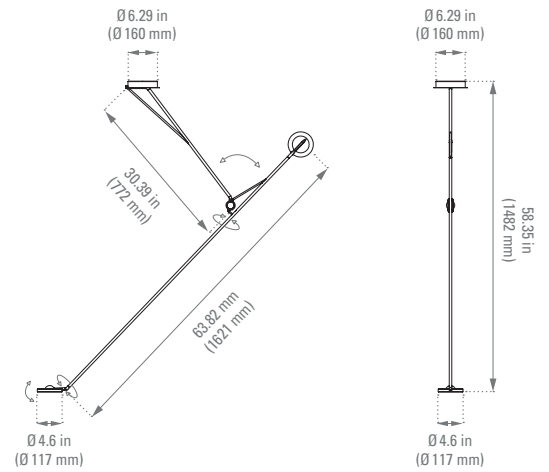

TECHNICAL SHEET
North America standards

FICHE TECHNIQUE
normes Nord Américaines



CEILING LAMP

PLAFONNIER

Materials Matériaux	Steel, aluminium Acier, aluminium
Net weight Poids net	3,1 Kg
Base Embase	Ø 6.29 in Ø 160 mm
Packaging Emballage	71.65 x 11.61 x 8.46 in 1820 x 295 x 215 mm
IP IP	20

Voltage Tension	110/240V
Class Classe	1
Watt Watt	4,5W
Source Source	INTEGRATED LED 2700K
Lumens output Lumens	4500 lm (nominal value) 4500 lm (valeur nominale)
Driver Driver	Driver supplied (2.02 x 1.26 x 0.67 in) 500 mA / 3-10,5V / 1,5-5,2W Driver fourni (51,5 x 32,8 x 17 mm) 500 mA / 3-10,5V / 1,5-5,2W
Wire Câble	NA
Switch Interrupteur	NA
Plug Fiches	NA

BODY CORPS



Black

BL