

) david  
trubridge

# Drop

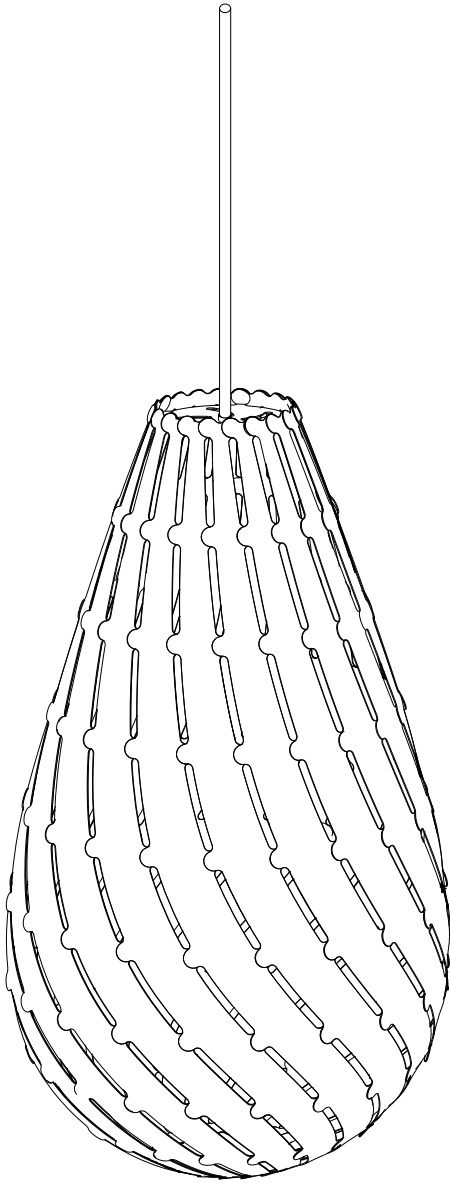

Assembly  
time approx



minutes

# Please check your components:

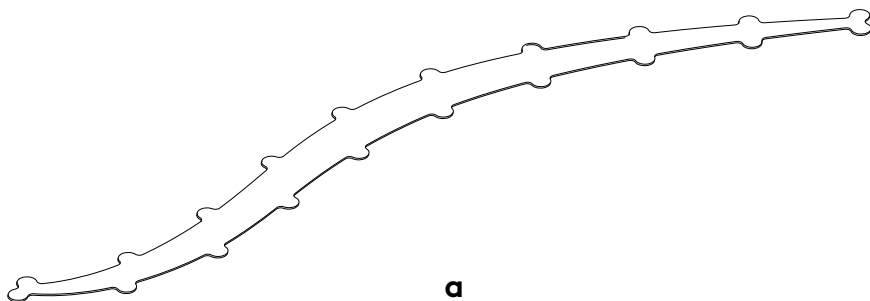

**a**  
**x22**

**(20 + 2 spare)**

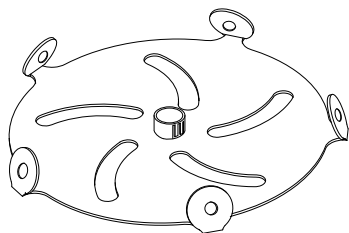

**b**  
**x1**



**c**  
**x200**

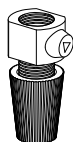

**d**  
**x1**

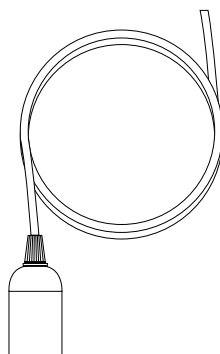

**e**  
**x1**



**x1**

EN - Optional lamp holder cover  
IT - Coperchio del portalampada opzionale  
DE - Abdeckung für Lampenfassung optional  
FR - Pièce en silicone (optionnelle)  
DK - Vælgfri dæksel for pæreholderen  
ES - Cobertura de portalámparas opcional

# Thank you for purchasing one of our kitsets



## ----- OLD SYSTEM

1 box = 1 assembled light

## ----- SEED SYSTEM

30 kitset boxes = 1 old box

**EN** Thank you for buying a Seed System kitset lightshade which is on average 1/30th of the volume of the assembled light. Seed System designs are only made possible through your involvement as you 'grow' your kitset into a lightshade. Together we have helped to minimize the effects of shipping, to reduce the number of trucks on the road and decrease the design's environmental footprint.

**IT** Grazie per aver acquistato il kit di assemblaggio di una lampada "Seed System", in media un 1/30 del volume della medesima lampada già assemblata. Il design "Seed System" è possibile soltanto tramite la vostra collaborazione, in quanto sarete voi stessi a far diventare il vostro kit una lampada vera e propria. Insieme cercheremo di minimizzare l'effetto del trasporto, diminuendo il numero di automezzi sulla strada e l'impatto ambientale dei prodotti.

**DK** Tak fordi du har købt en 'Seed System' kitset lampe der fylder gennemsnitlig 1/30 del af den samlede lampe. Seed System designet er kun gjort muligt gennem dit engagement, da du selv skal færdiggøre dit kitset som en lampeskærm. På den måde har vi sammen været med til at minimere skibsfart samt vi reducerer antallet af lastbiler på vejene. Dermed mindskes det miljømæssige fodaftryk.

**FR** Nous vous remercions d'avoir acheté un luminaire "Seed System". Vendus en kit, nos luminaires représentent en moyenne 1/30ème de leur volume assemblé, vous avez donc contribué à protéger l'environnement en réduisant le nombre de camions de transport sur les routes.

**DE** Vielen Dank für den Kauf der Seed System Kitset Licht Schatten Leuchte . Das Kitset entspricht dem Verhältnis im Durchschnitt 1/30 des Volumens der zusammengebauten Leuchte/ Lampe. Seed System Designs sind nur durch Ihre Beteiligung möglich, da Sie Ihr Kitset in eine Leuchte mit Lichtschatten "verwandeln". Gemeinsam haben wir es geschafft die Folgen des weltweiten Frachtverkehrs zu minimieren, die Anzahl der LKWs auf den Straßen zu reduzieren und den ökologischen Fußabdruck zu verkleinern.

**ES** Gracias por la compra del sistema kitset "Seed" de la lámpara la cual tiene solamente de media 1/30o del volumen de la luz montada. Los diseños del sistema "Seed" sólo se han hecho posibles gracias a su participación de "transformar" su kitset en una sombra de luz. Juntos hemos ayudado a minimizar los efectos de envío, para reducir el número de camiones en la carretera y disminuir la huella ambiental.

# 1

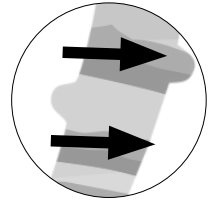
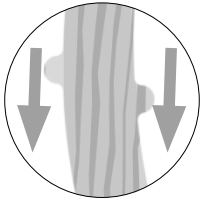
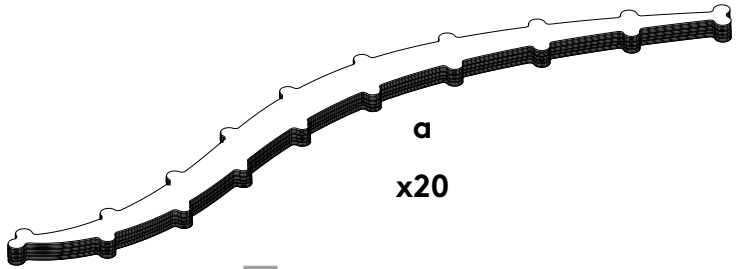
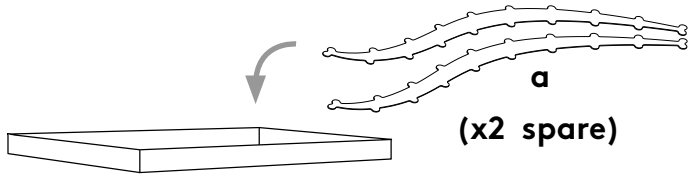
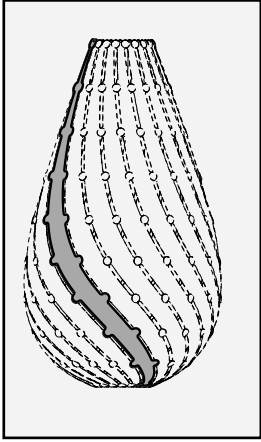

EN - Lay piece face up, so wood grain direction goes up and down the length

IT - Posare il pezzo a faccia in su, quindi la direzione della venatura del legno sale e scende lungo la lunghezza

DE - Legen Sie das Stück mit der Vorderseite nach oben, so dass die Richtung der Holzmaserung der Länge nach auf und ab geht

FR - la face ou le grain du bois suit la longueur du module doit être placée vers le haut, face à vous

DK - Læg stykke med forsiden opad, så trækornets retning går op og ned langs

ES - Coloque la pieza boca arriba, de modo que la dirección del grano de madera suba y baje a lo largo

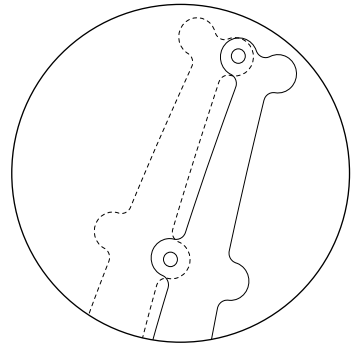
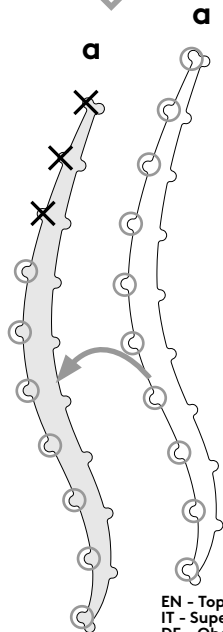
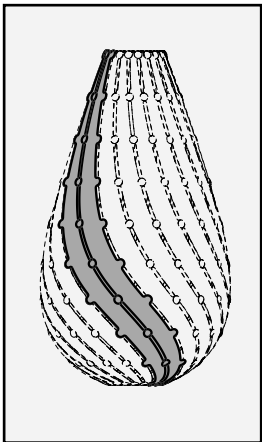
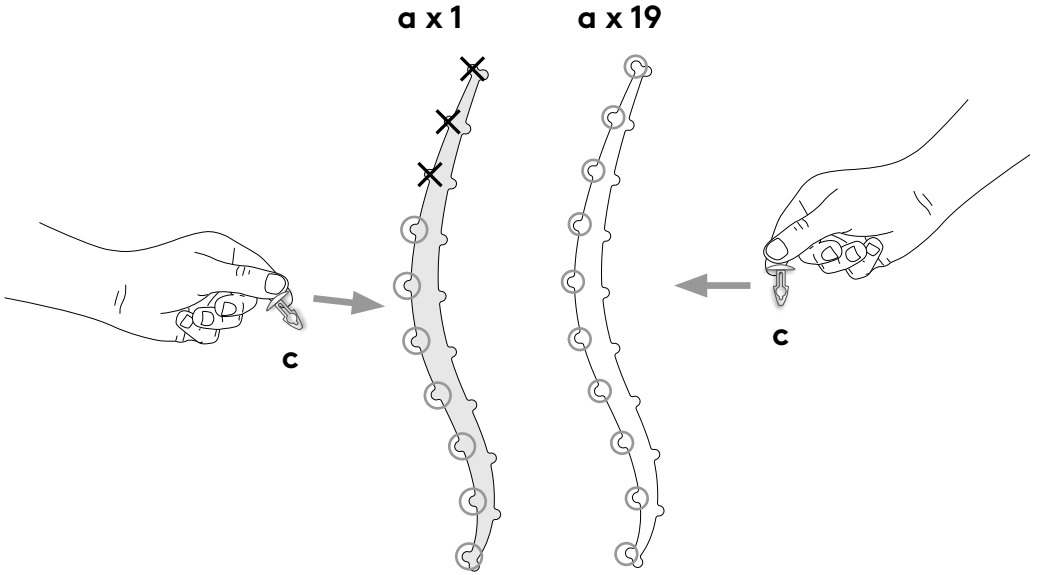

EN - Under  
IT - Sotto  
DE - Unten  
FR - en-dessous  
DK - Under  
ES - Debajo

EN - Top  
IT - Superiore  
DE - Oben  
FR - au-dessus  
DK - øverst  
ES - Encima

# 3

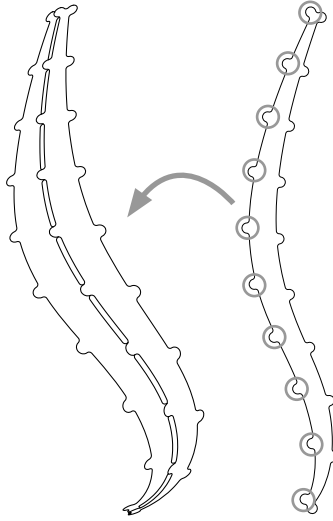
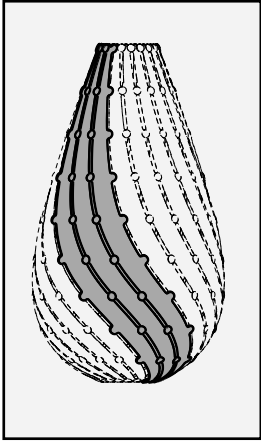

EN - Under  
IT - Sotto  
DE - Unten  
FR - en-dessous  
DK - Under  
ES - Debajo

EN - Top  
IT - Superiore  
DE - Oben  
FR - au-dessus  
DK - øverst  
ES - Encima

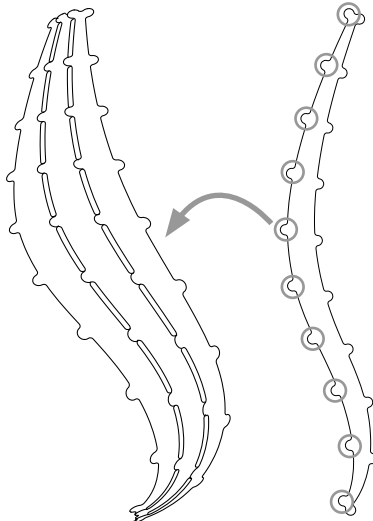
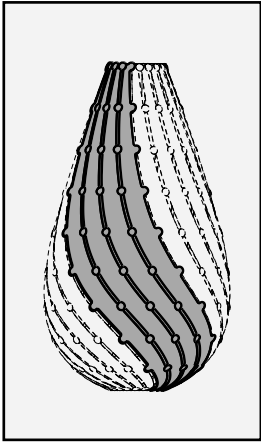

EN - Under  
IT - Sotto  
DE - Unten  
FR - en-dessous  
DK - Under  
ES - Debajo

EN - Top  
IT - Superiore  
DE - Oben  
FR - au-dessus  
DK - øverst  
ES - Encima

# 4

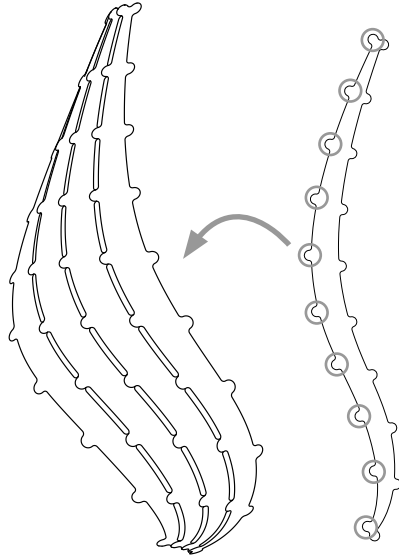
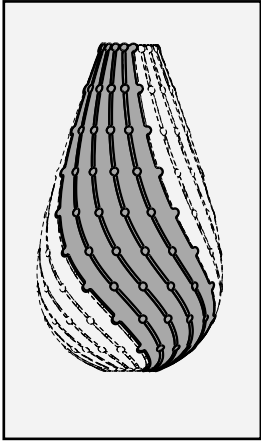

EN - Under  
IT - Sotto  
DE - Unten  
FR - en-dessous  
DK - Under  
ES - Debajo

EN - Top  
IT - Superiore  
DE - Oben  
FR - au-dessus  
DK - øverst  
ES - Encima

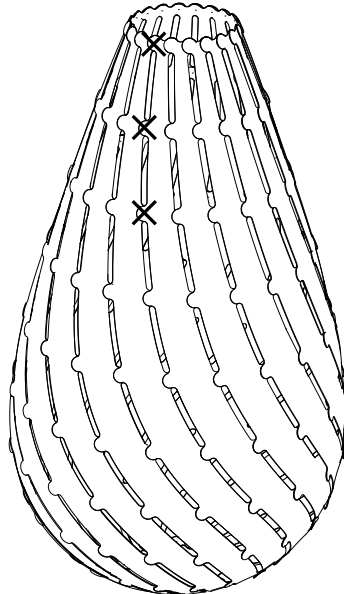
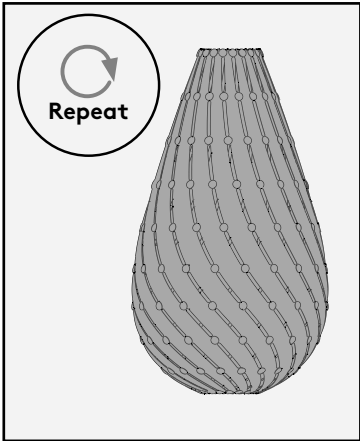

# 5

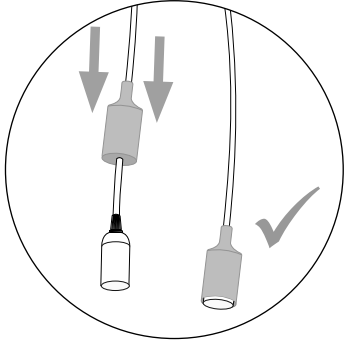

EN - Slide the silicone cover on top the bulb holder

IT - Far scorrere il coperchio in silicone sulla parte superiore del portalampada

DE - Schieben Sie die Silikonabdeckung auf die Lampenfassung

FR - Recouvrir la douille avec la pièce en silicone

DK - Skub silikonafdækningen ovenpå pæreholderen

ES - Empuje la cobertura de silicona en la parte superior del portalámparas

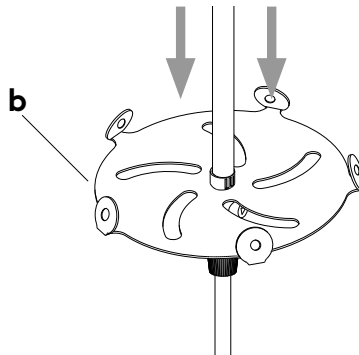
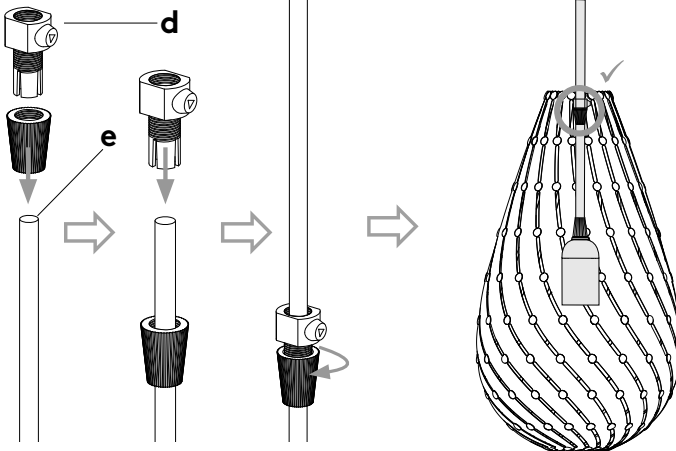



# 6



E27 LED  
(E26 USA ONLY)

- EN - Energy efficient lamp (max 60 watts)
- IT - Efficienza energetica della lampada (max 60 watt)
- DE - Energiesparlampe (max 60 Watt)
- FR - Energie de l'ampoule (max 60 watt)
- DK - Vi anbefaler at bruge energisparepære (max 60 watt)
- ES - Bombilla de bajo consumo (máximo 60 vatios)

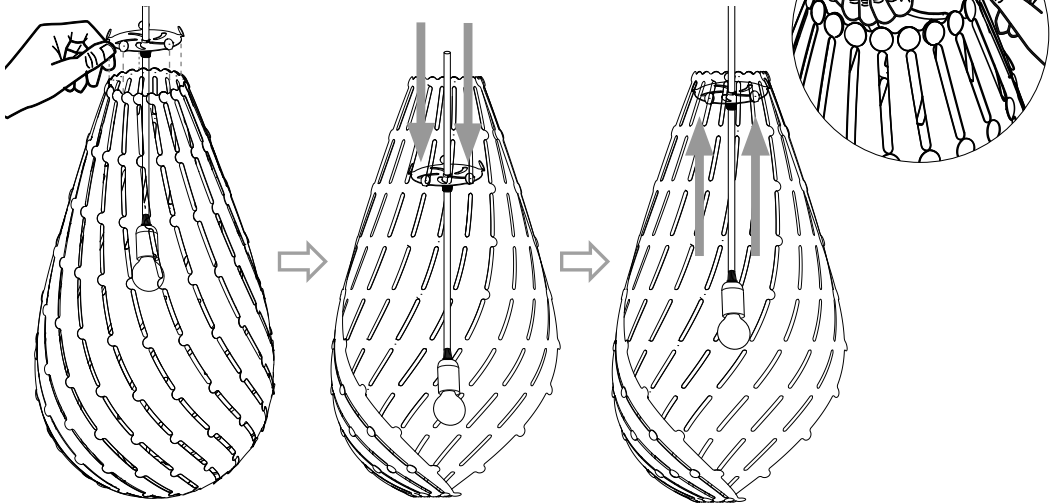
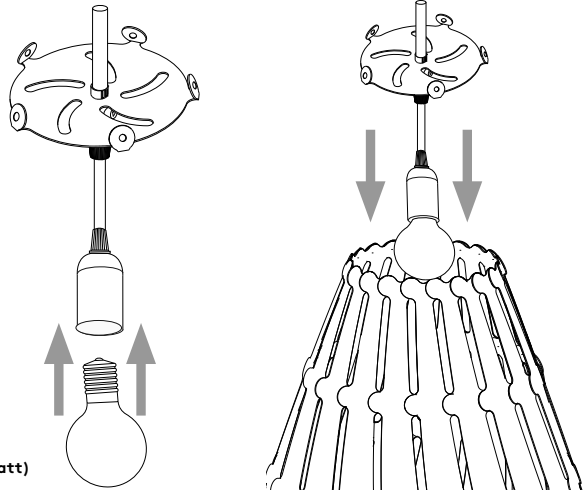

# 7

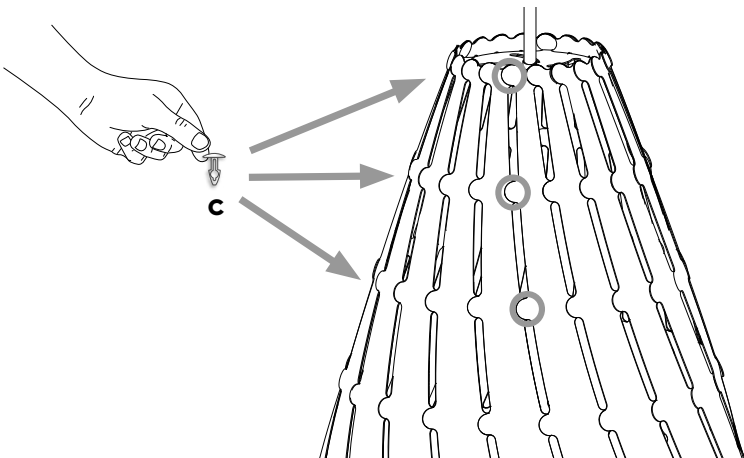

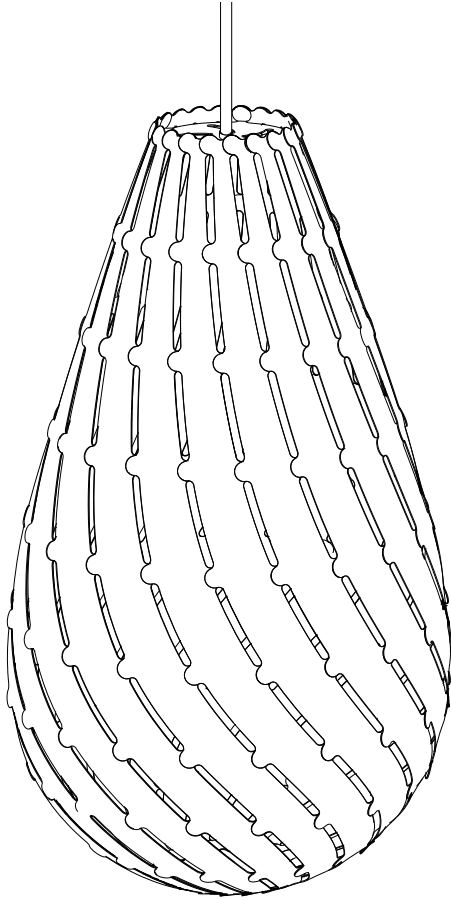

Installation / installazione / Installing / Instalacion

Limited Warranty / Garantie Limitee / Beschränkte Garantie / Garantía Limitada / Begrænset garanti / garanzia limi tata

Care Instructions / Iamanutention / Pflegehinweise Instrucciones de cuidado / Vedligeholdelse /manuttenzione

#### Installation / installazione / Installing / Instalacion

EN The light must be installed by a qualified Electrician in accordance with national wiring regulations - DO NOT attempt to install it yourself. A lamp holder with electric cord is included but a lamp is not supplied. **TO BE INSTALLED IN DRY INDOOR AREAS ONLY.**

FR Le luminaire doit être installé par un électricien qualifié, conformément aux réglementations nationales - Ne l'installez pas vous-même! Une douille et un cordon électrique sont inclus, mais l'ampoule n'est pas fournie. **Ce luminaire est conçu pour l'intérieur uniquement.**

DE Das Licht muss von einem qualifizierten Elektriker in Übereinstimmung mit nationalen Installationsvorschriften installiert werden - Versuchen Sie NICHT, es selbst zu installieren. Eine Lampenhalterung mit Stromkabel ist im Lieferumfang enthalten, aber eine Birne wird nicht mitgeliefert. Die Lampe nur in trockenen Innenräumen installieren. **TO in trockenen Innenräumen installiert werden.**

ES La luz debe ser instalada por un electricista cualificado de acuerdo con las regulaciones nacionales de cableado - NO intente instalar la lámpara usted mismo. Un soporte de la lámpara con el cable eléctrico está incluido, pero una bombilla no se suministra. **A INSTALAR EN AREAS INTERIORES SECOS.**

DK Lyset skal installeres af en autoriseret elektriker i overensstemmelse med nationale forskrifter for elektriske installationer - Forsøg IKKE at installere det selv. En fætning med ledning er inkluderet, men en lyskilde medfølger ikke. **UDELUKKENDE TIL MONTERING I NEDENDØRS.**

IT La lampada deve essere installata da un elettricista qualificato in accordo con le vigenti normative nazionali - non provate a installarla da soli. Un portalampada con cavo elettrico è incluso ma la lampadina non è fornita. **DA INSTALLARE SOLO IN AREE INTERNE E ASCIUTTE.**

#### Limited Warranty / Garantie Limitee / Beschränkte Garantie / Garantía Limitada / Begrænset garanti / garanzia limi tata

EN This light is warranted for three years from date of purchase for failure of parts, not including fair wear and tear. Please check now that all parts are present - we can only replace anything missing before assembly.

FR Ce luminaire est garanti pendant trois ans à compter de la date d'achat. La garantie exclue l'usure normale du luminaire (vieillessement naturel du bois, couleur devenant fade...). Prenez soin de vérifier dès maintenant que toutes les pièces constituant la lampe sont au complet - nous ne remplaçons que les pièces manquantes avant assemblage.

DE Diese Lampe steht für drei Jahre ab dem Kaufdatum für den Defekt von Teilen unter Garantie. Darunter gilt nicht normale Abnutzung. Prüfen sie jetzt, dass alle Teile vorhanden sind - Fehlende oder defekte Teile können nur vor der Montage ersetzt werden.

ES Esta luz tiene una garantía de tres años contados desde la fecha de compra para el fracaso de las partes, sin incluir el uso y desgaste normal. Por favor, comprueba ahora que todas las partes están presentes - sólo podemos reemplazar partes faltantes antes del montaje.

DK Denne lampe er under garanti i tre år fra købsdatoen. Garantien gælder defekte dele, dog ikke grundet almindelig slid og ælde. Kontrollér nu, at alle dele er til stede - vi erstatter kun manglende dele før samlesættes samles.

IT La garanzia è di tre anni dalla data di acquisto, è valida per i pezzi rotti o difettosi e non copre il normale deterioramento o i danni. Controllate sin da subito che tutte le parti siano presenti - sostituiamo eventuali pezzi mancanti solo prima dell'assemblaggio del prodotto.

#### Care Instructions / Iamanutention / Pflegehinweise Instrucciones de cuidado / Vedligeholdelse /manuttenzione

EN All wooden and/or polycarbonate lights are intended for use in dry interior conditions only, and can be cleaned with a soft cloth dampened in warm water when light is switched off.

FR Tous nos luminaires en bois et / ou polycarbonate sont destinés à un usage en intérieur uniquement. Ils peuvent être nettoyés avec un chiffon légèrement trempé dans de l'eau tiède savonnée (éteindre la lampe avant de la nettoyer).

DE Alle Holz-und / oder Polycarbonat-leuchten sind nur für den Einsatz in trockenen Innenbereichen vorgesehen und wenn das Licht ausgeschaltet ist, kann diese mit einem weichen Tuch mit warmen Seifenwasser gereinigt werden.

ES Todas las luces de madera y / o de policarbonato están diseñados para uso en zonas interiores secas solamente, y se pueden limpiar con un paño suave humedecido en agua tibia con jabón cuando la luz está apagada.

DK Alle træ-og/eller polycarbonat lamper er beregnet til brug indendørs, og kan rengøres med en blød klud fugtet i varmt sæbevand, når lyset er slukket.

IT Istruzioni per la cura e manutenzione: Tutte le lampade in legno e/o policarbonato sono progettate soltanto per uso interno con ambienti asciutti e possono essere pulite con un panno morbido inumidito in acqua tiepida e sapone, avendo cura di spegnere la luce della lampada per la pulizia.

Follow us on



www.davidtrubridge.com