

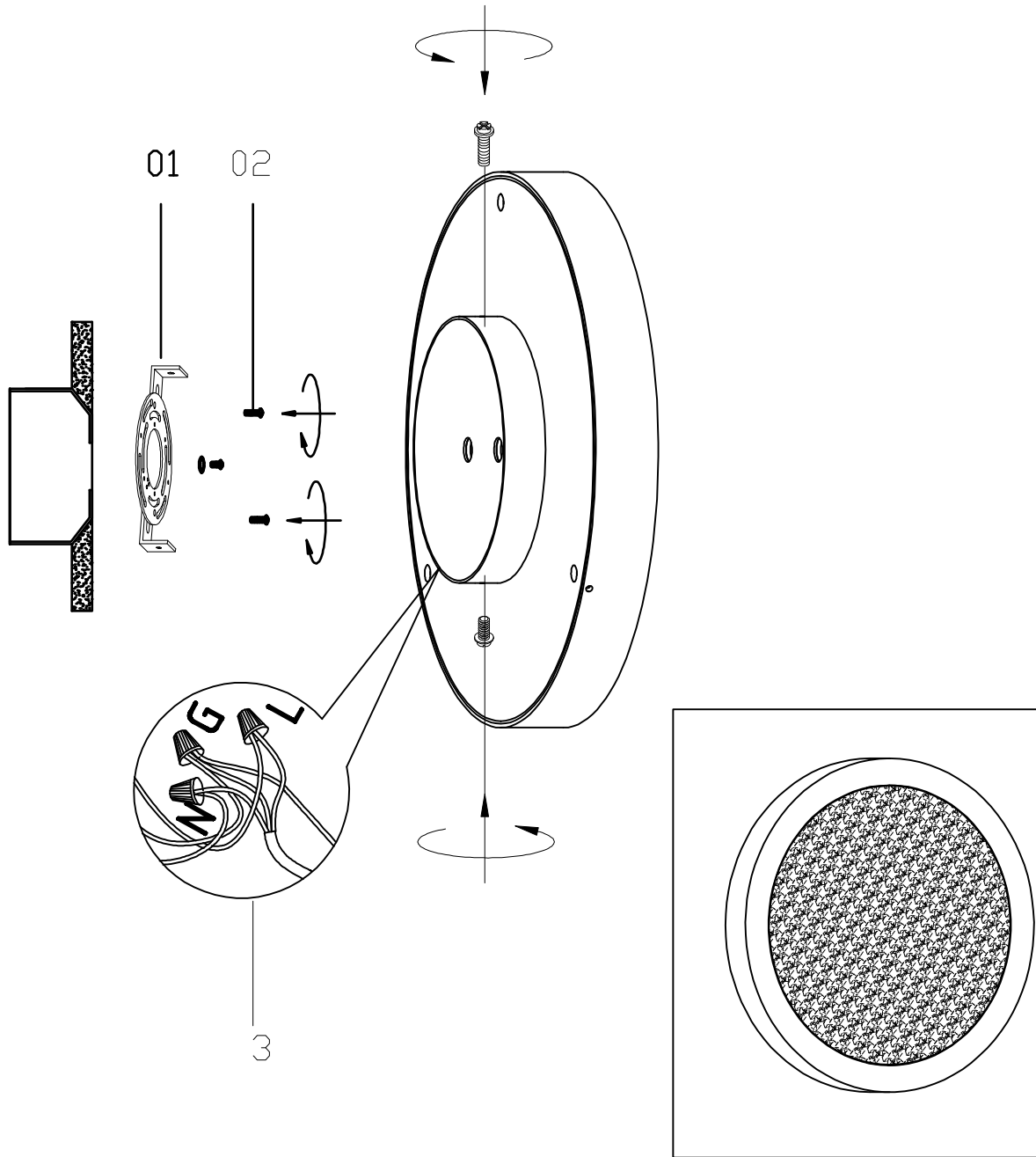

Specification of installation

In order to ensure safety use, please notice the following items:

- Read and understand the whole Specification.
- Suitable for the use of 110~130V and 60Hz.
- Please wear gloves as installment and avoid rot on the surface of plating.
- Must be installed on the fixed places and be checked annually.
- Please turn off the lighting source by soft cloth as cleaning prohibited to use of rotted detergent.
- Please connect with the local sales service center when there are any abnormality.



Note: Must be installed by a licensed electrician.

Product coding: HF5012