

HF2801-AB

INSTALLATION SHEET

START FROM HERE

- Make sure power is completely off at the fuse box
- Have you fixture installed by a qualified licensed electrician
- Prepare everything in a clear area
- Wear gloves at all times during this installation
- Read instructions carefully before you start assembly
- Keep this instruction sheet for future reference

Please Note:

- All AVE LED fixtures come with pre-wired LED module(s)
- Unless instructed to do so, please do not touch any part of the LED module(s) as any unnecessary contact with the module could cause permanent damage
- For dimming, an ELV (Electronic Low Voltage) type of dimmer is required

Technical Support: 8186289149

Specification of installation

In order to ensure safety use, please notice the following items:

- Read and understand the whole Specification.
- Suitable for the use of 110~130V and 60Hz.
- Please wear gloves as installment and avoid rot on the surface of plating.
- Must be installed on the fixed places and be checked annually.
- Please turn off the lighting source by soft cloth as cleaning prohibited to use of rotted detergent.
- Please connect with the local sales service center when there are any abnormality.

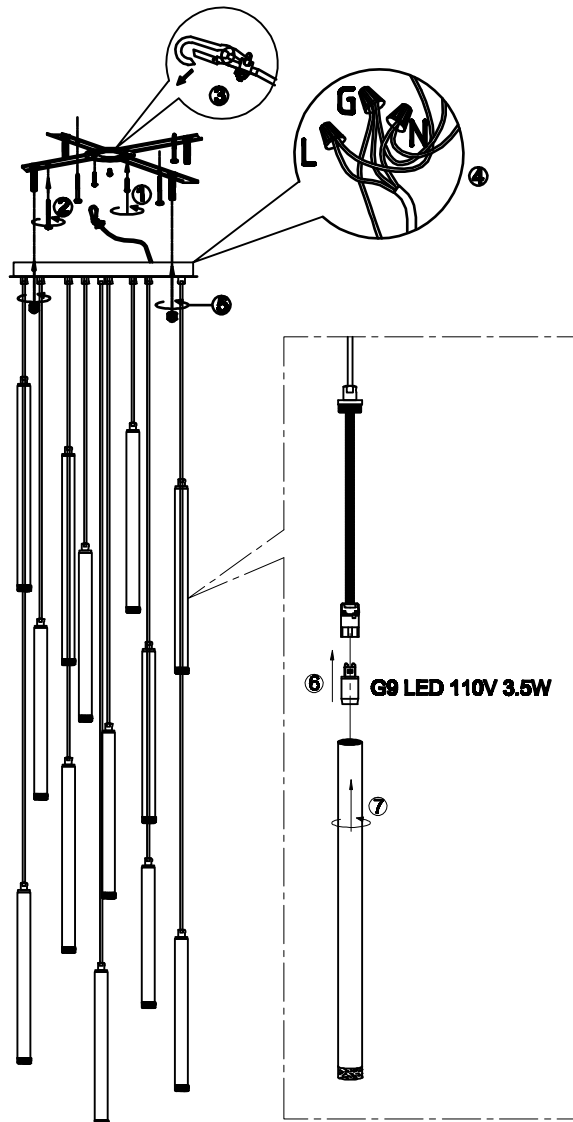

AVE LIGHTING

9000 Fullbright Ave. Chatsworth Ca. 91311
O: (818) 628-9149 ; (800) 798-0409 F: (888) 870-0105
W: WWW.AVENUELIGHTING.COM