

# SABINA 280 LED

astro

8159 / SKU 1292008

**EN** PLEASE READ THE INSTRUCTIONS CAREFULLY

THIS PRODUCT MUST BE INSTALLED IN ACCORDANCE WITH THE APPLICABLE INSTALLATION CODE BY A PERSON FAMILIAR WITH THE CONSTRUCTION AND OPERATION OF THE PRODUCT AND THE HAZARDS INVOLVED CONSULT A QUALIFIED ELECTRICIAN TO ENSURE CORRECT BRANCH CIRCUIT CONDUCTOR.

**FR** LIRE ATTENTIVEMENT LES INSTRUCTIONS AVANT DE COMMENCER LE MONTAGE

CE PRODUIT DOIT ÊTRE INSTALLÉ SELON LE CODE D'INSTALLATION PERTINENT, PAR UNE PERSONNE QUI CONNAÎT BIEN LE PRODUIT ET SON FONCTIONNEMENT AINSI QUE LES RISQUES INHÉRENTS CONSULTER UN ÉLECTRICIEN QUALIFIÉ POUR VOUS ASSURER QUE LES CONDUCTEURS DE LADÉRIVATION SONT ADÉQUATS.

**ES** LEA DETENIDAMENTE LAS INSTRUCCIONES

ESTE PRODUCTOR DEBE SER INSTALADO SEGUN EL CODIGO DE INSTALACION APLICABLE POR UNA PERSONA QUE CONOZCA LE CONSTUSSION Y EL FUNCIONAMIENTO DEL PRODUCTO Y LOS RIESGOS QUE SUPONE. CONSULTAR A UN ELECTRICISTA CALIFICADO PARA ASEGURAR LA ELECCION DEL CONDUCTOR DE CIRCUITO DERIVADO.



COVERED CEILING MOUNT ONLY  
Installation sur plafond couvert seulement  
Exclusivamente para fijacion en techo cubierto

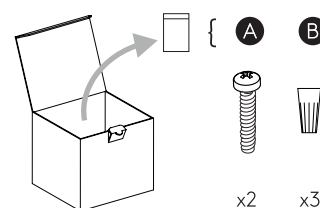
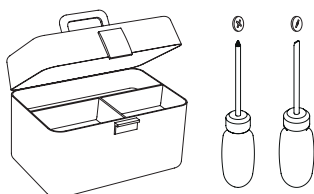

1

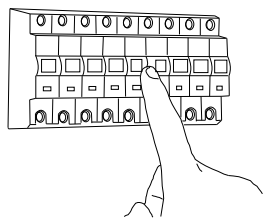

TURN OFF POWER  
Couper Le Courant! / Corte La Corriente!

WHITE SUPPLY WIRE / NEUTRAL	WHITE OR IDENTIFIED FIXTURE WIRE UL LISTED WIRE NUTS	FILS DE COURANT BLANC / NEUTRE	FILS DE CONNECTEUR BLANC OU IDENTIFIABLE COINCEUR DE RELAIS UL QUALIFIE	CABLE DE SUMINISTRO BLANCO / NEGATIVO	CABLE A LÁMPARA BLANCO / NEGATIVO CONOS ELÉCTRICOS
BLACK SUPPLY WIRE	PLAIN OR BLACK FIXTURE WIRE	FILS DE COURANT NOIR	FILS DE CONNECTEUR NOIR OU SANS MARQUES	CABLE DE SUMINISTRO NEGRO	CABLE A LÁMPARA NEGRO
BARE, OR GREEN GROUND WIRE FROM SUPPLY	BARE, OR GREEN FIXTURE GROUND WIRE	FILS VERT OU NEUTRE DU COURANT	FILS VERT OU NEUTRE	CABLE DESNUDO / VERDE TIERRA FÍSICA DEL SUMINISTRO	CABLE A LÁMPARA VERDE / TIERRA FÍSICA
BARE, OR GREEN GROUND WIRE FROM SUPPLY	OR GREEN GROUND SCREW	FILS VERT OU NEUTRE DU COURANT	OU VIS DE TERRE VERTE	CABLE DESNUDO / VERDE TIERRA FÍSICA DEL SUMINISTRO	OR TORNILLO VERDE DE TIERRA

2

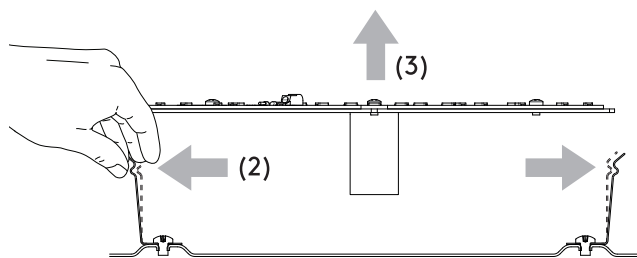
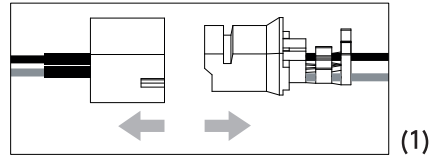

3

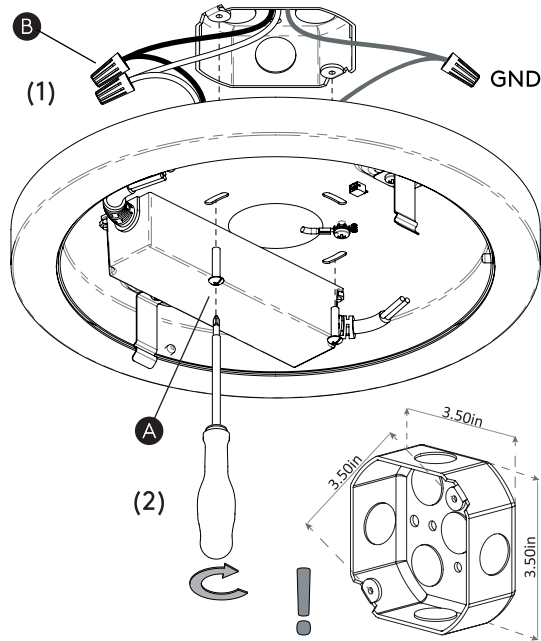

4

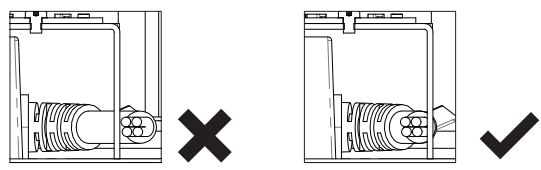
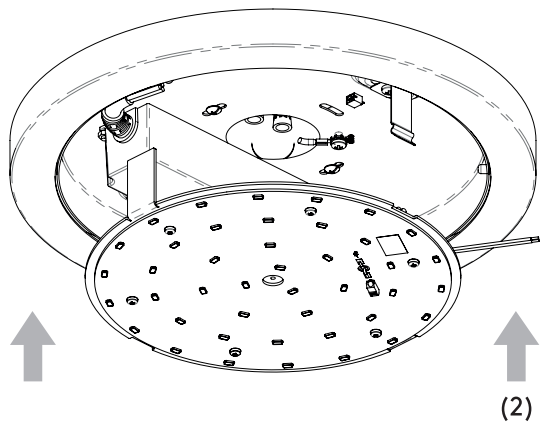
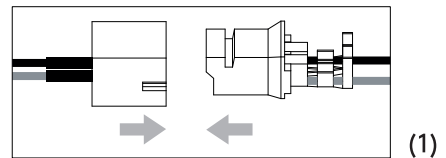

5

