

Mashiko 230 Round

astro

SKU 1121xxx

INSTALLATION INSTRUCTIONS / INSTRUCTIONS D'INSTALLATION / INSTRUCCIONES DE INSTALACIÓN

EN PLEASE READ THE INSTRUCTIONS CAREFULLY

THIS PRODUCT MUST BE INSTALLED IN ACCORDANCE WITH THE APPLICABLE INSTALLATION CODE BY A PERSON FAMILIAR WITH THE CONSTRUCTION AND OPERATION OF THE PRODUCT AND THE HAZARDS INVOLVED CONSULT A QUALIFIED ELECTRICIAN TO ENSURE CORRECT BRANCH CIRCUIT CONDUCTOR.

FR LIRE ATTENTIVEMENT LES INSTRUCTIONS AVANT DE COMMENCER LE MONTAGE

CE PRODUIT DOIT ÊTRE INSTALLÉ SELON LE CODE D'INSTALLATION PERTINENT, PAR UNE PERSONNE QUI CONNAÎT BIEN LE PRODUIT ET SON FONCTIONNEMENT AINSI QUE LES RISQUES INHÉRENTS CONSULTER UN ÉLECTRICIEN QUALIFIÉ POUR VOUS ASSURER QUE LES CONDUCTEURS DE LADÉRIVATION SONT ADÉQUATS.

ES LEA DETENIDAMENTE LAS INSTRUCCIONES

ESTE PRODUCTOR DEBE SER INSTALADO SEGUN EL CODIGO DE INSTALACION APLICABLE POR UNA PERSONA QUE CONOZCA LE CONSTUSSION Y EL FUNCIONAMIENTO DEL PRODUCTO Y LOS RIESGOS QUE SUPONE. CONSULTAR A UN ELECTRICISTA CALIFICADO PARA ASEGURAR LA ELECCION DEL CONDUCTOR DE CIRCUITO DERIVADO.

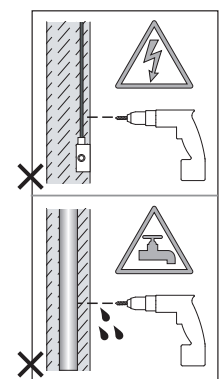

Covered ceiling mount only
Installation sur plafond couvert seulement
Exclusivamente para fijacion en techo cubierto

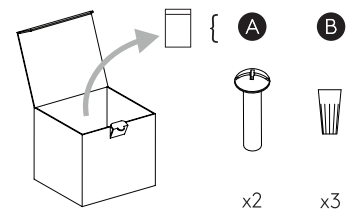
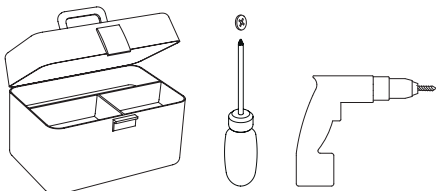

1

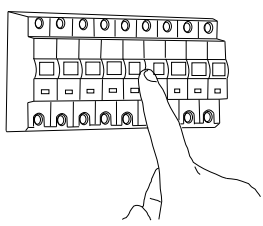

Turn Off Power
Couper Le Courant! /
Corte La Corriente!

2

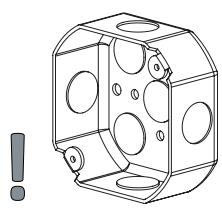

Junction box is not included
La boîte de jonction n'est pas incluse
La caja de conexión no está incluida

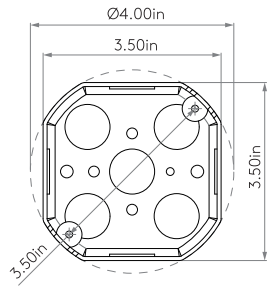

3

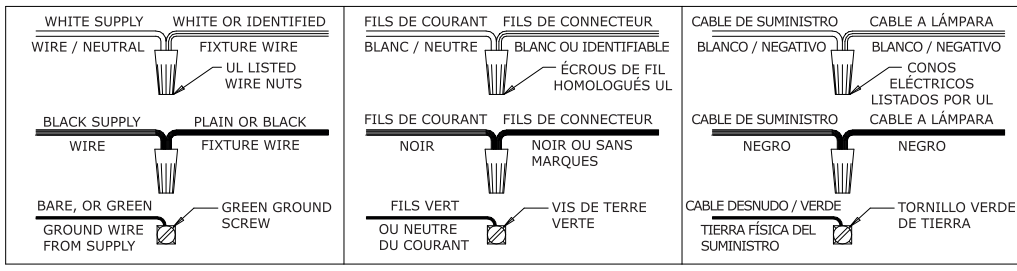

! Use the appropriate UL listed wire nut for the number of conductors in the installation/
 Utilisez l'écrou de fil homologué UL approprié pour le nombre de conducteurs dans l'installation/
 • Utilice el cono eléctrico apropiado listado por UL para la cantidad de conductores en la instalación

4

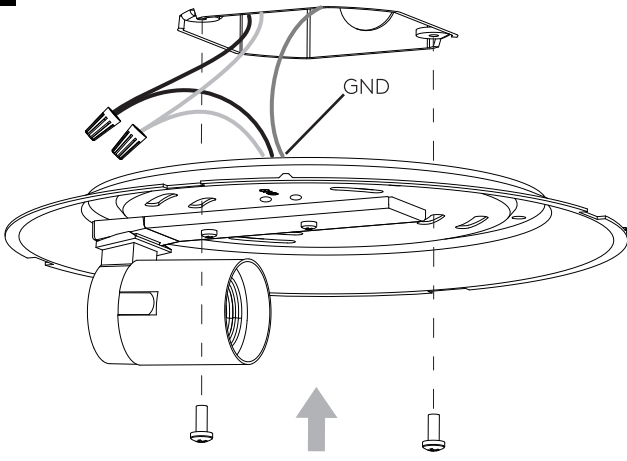

5

