

AETHER 2"- Square Downlight Trimless R2ASDL

WAC LIGHTING

Responsible Lighting®

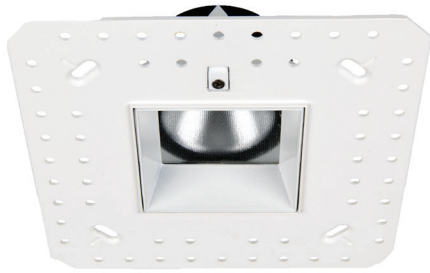

Fixture Type:

Catalog Number:

Project: _____

Location: _____

PRODUCT DESCRIPTION

Shallow housing that is designed to fit in tight plenum spaces without sacrificing lumen output.

FEATURES

- Designed to fit in tight plenum
- Wet location listed for trims
- 2" trim aperture, 2" housing height
- 35° cut-off angle
- Universal input voltage (120V-277V)
- 5 year WAC Lighting product warranty

SPECIFICATIONS

Construction: Die-cast aluminum trim with die-cast aluminum heat sink

Dimming: 100% - 5% with 0-10V

100% - 5% with Electronic Low Voltage (ELV)/ TRIAC

Input: 120V-277V AC

Power: 15W, power factor 0.98

Mounting: Retention clips firmly hold trim to housing.

Finish: Powder coated white, black, enamel coated haze, electroplated brushed nickel

Standards: UL & cUL Listed, wet location listed trims, Title 24 JA8-2016

Compliant

Ceiling thickness: ½" - 1"

TRIM (SEE NEXT PAGE FOR HOUSING)

	Beam	Color Temp	CRI	Lumen	CBCP	Finish	Interior/Trim
<p>R2ASDL Square</p>	S 17°	827 2700K	85	1230	5998	HZ WT BK BN	<i>Haze</i> <i>White</i> <i>Black</i> <i>Brushed Nickel</i>
		830 3000K	85	1295	6310		
		835 3500K	85	1320	6436		
		840 4000K	85	1330	6499		
		927 2700K	90	1025	5000		
		930 3000K	90	1065	5185		
	N 24°	827 2700K	85	1230	3856	HZ WT BK BN	<i>Haze</i> <i>White</i> <i>Black</i> <i>Brushed Nickel</i>
		830 3000K	85	1295	4057		
		835 3500K	85	1320	4138		
		840 4000K	85	1330	4179		
		927 2700K	90	1025	3215		
		930 3000K	90	1065	3334		
F 40°	827 2700K	85	1205	2122	HZ WT BK BN	<i>Haze</i> <i>White</i> <i>Black</i> <i>Brushed Nickel</i>	
	830 3000K	85	1270	2233			
	835 3500K	85	1295	2277			
	840 4000K	85	1310	2300			
	927 2700K	90	1005	1769			
	930 3000K	90	1045	1835			
W 50°	827 2700K	85	1135	1386	HZ WT BK BN	<i>Haze</i> <i>White</i> <i>Black</i> <i>Brushed Nickel</i>	
	830 3000K	85	1195	1458			
	835 3500K	85	1220	1487			
	840 4000K	85	1230	1502			
	927 2700K	90	945	1155			
	930 3000K	90	980	1198			

R2A DL- -
Example: R2ASDL-N930-WT

wacighting.com
Phone (800) 526.2588
Fax (800) 526.2585

Headquarters/Eastern Distribution Center
44 Harbor Park Drive
Port Washington, NY 11050

Central Distribution Center
1600 Distribution Ct
Lithia Springs, GA 30122

Western Distribution Center
1750 Archibald Avenue
Ontario, CA 91760

AETHER - Housing

HR-2LED-H13A

WAC LIGHTING

Responsible Lighting®

HOUSING

Model

	HR-2LED-H13A	<i>New Construction IC-rated, Airtight</i>
	HR-2LED-H13AC	<i>New Construction IC-rated, Airtight Chicago Plenum</i>

HR-2LED-H13 _____

Example: **HR-2LED-H13A**

waclighting.com
Phone (800) 526.2588
Fax (800) 526.2585

Headquarters/Eastern Distribution Center
44 Harbor Park Drive
Port Washington, NY 11050

Central Distribution Center
1600 Distribution Ct
Lithia Springs, GA 30122

Western Distribution Center
1750 Archibald Avenue
Ontario, CA 91760