

1294

LED-UL



Project name:
Date: Specifier:
Line: Frame
Family: Pendant
Description: Frame Accord Pendant 1294

Material: Natural Wood veneer MDF and Acrylic
Weight:

Integrated LED Strip 1 unit Driver housed in the Junction box
Dimmable, ELV

Color Temperature: 2700K, 3000K, 3500K or 4000K
CRI: 90
Luminous Flux: 900lm
Delivered Lumens: 450lm
Total Power: 9W

Input Voltage: 110V or 277V
Input Frequency: 60 Hz
Isolation: Class II

Height Adjustment Limit: 160cm/63in

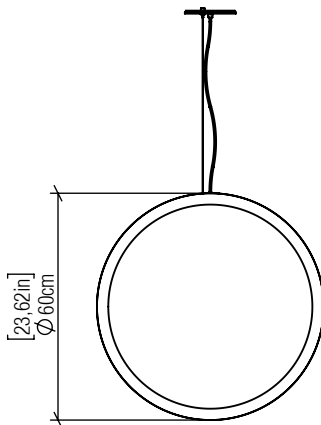
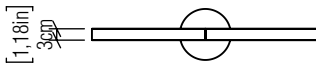

FINISHING OPTION:

	02 MATTE BLACK		27 GOLD
	06 IMBUIA		29 TEAL
	07 WHITE		30 OLIVE GREEN
	09 LOURO FREIJÓ		31 FERRARI RED
	12 TEAK		32 COPPER
	15 CAPPUCCINO		33 BRONZE
	18 AMERICAN WALNUT		34 MAPLE
	22 GLOSSY BLACK		38 PALE GOLD
	25 IREDESCENT WHITE		39 LEAD GREY
	26 LIGHT PINK		40 SATIN BLUE