

WARNING!

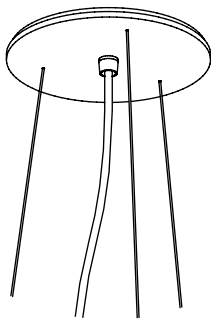

Be sure electrical power is OFF before and during installation or maintenance. The luminaire must be installed by a qualified electrician, in accordance with all applicable local codes.

Ensure that the rated luminaire voltage requirements are compatible with the available mains supply in which it will be installed. All LEDs are included in your lamp. Never touch the LED surface with your bare hands as this may reduce the life of your LED. Do not alter, relocate or remove any electrical component.

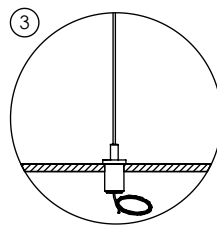
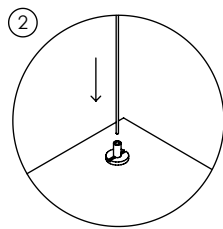
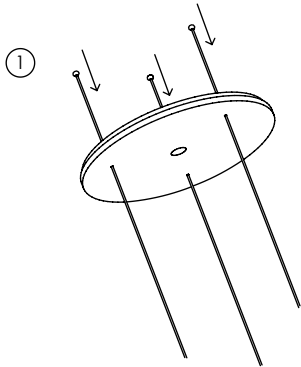

Line: Conical
Family: Pendant
Description: Conical Accord Pendant 1146

Material: Natural Wood Veneer MDF and Acrylic
Weight:

INSTALLING THE FIXTURE ON CEILING

Turn OFF the power before start the installation.

- ① Align and mark on ceiling the position of the holes where anchors will be installed. Drill using an 8mm drill bit and install the supplied plastic plugs.
- ② Screw the anchors to the plastic plugs.
- ③ Pass the support steel cables through the holes on anchors making sure the ball-end of the cables are in the inner part. Then, screw these assemblies into each anchor fixed on ceiling.
- ④ Insert the other end of each cable into the adjustable anchors mounted on top of the luminaire until they are tight.
- ⑤ Reserve extra cables by wrapping them inside of the luminaire. It is not necessary to cut the excess off, but ensure that the cables cannot touch any of the electrical connections.

ADJUSTING THE FIXTURE HEIGHT

Choose the height (H) you want the luminaire to hang below the ceiling by pushing on the anchor to release tension. While pressing the tip, move the cable until it reaches the desired length. Release the tip and the cable will be locked again. Final adjustments can be made after the fixture is mounted.

Now you are ready to make the electrical connection.

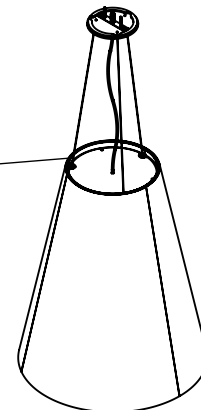
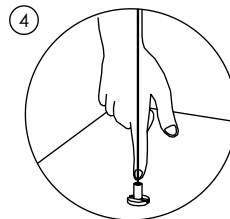

ATTENTION!



FAILURE TO COMPLY WITH THESE INSTRUCTIONS MAY CAUSE ACCIDENTS AND LOSS OF PRODUCT WARRANTY. Its recommended to read these instructions completely and carefully before proceeding.

SAVE THESE INSTRUCTIONS FOR FUTURE REFERENCE.

ACCORD Lighting guarantees coverage against manufacturing defects including electrical components and finishes, for a period of three years, under normal use, from the date of purchase. For warranty service, please contact your local dealer for further instructions. Proof of date of purchase will be required for validation of warranty service.

The responsibility of the manufacturer regarding the product warranty is related to the correct observation of the instructions contained in this manual. The manufacturer is not responsible for any damage to the product caused by accidents, alterations of any kind, improper usage or improper installation. See the website for additional warranty details.

ACCORD Lighting reserves the right to change the dimensions and specifications contained in this manual without prior notice, in accordance with its policy of continuous product improvement. Please, contact the manufacturer if additional information is necessary. The illustrations in this manual are for guidance only and may vary in scale, dimensions and model details.

WARNING!



Be sure electrical power is OFF before and during installation or maintenance.
The luminaire must be installed by a qualified electrician, in accordance with all applicable local codes.

Ensure that the rated luminaire voltage requirements are compatible with the available mains supply in which it will be installed.
All LEDs are included in your lamp. Never touch the LED surface with your bare hands as this may reduce the life of your LED.
Do not alter, relocate or remove any electrical component.

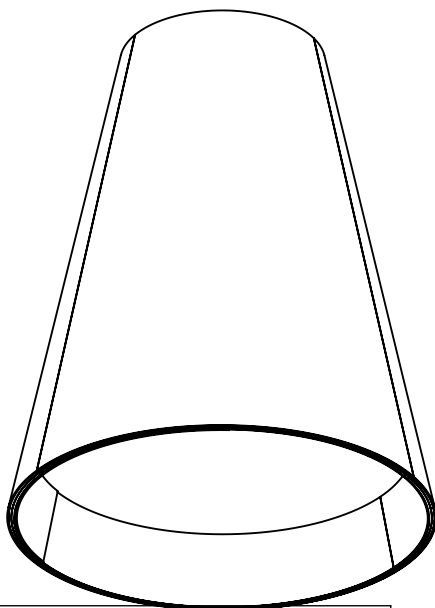
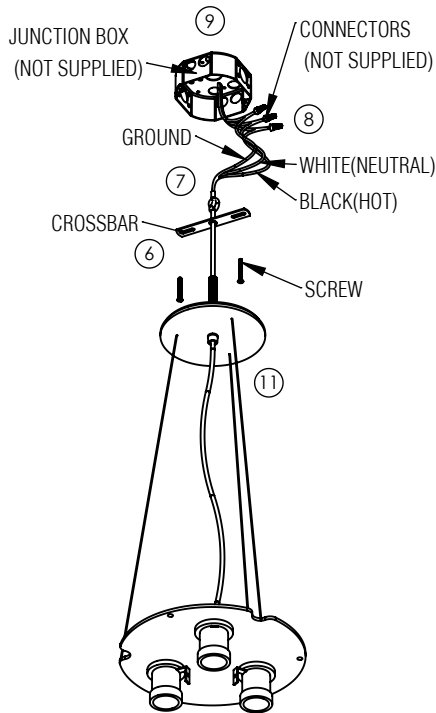

Color Temperature: Lamp dependent
CRI: Lamp dependent
Luminous Flux: Lamp dependent
Total Power: Lamp dependent

Input Voltage: 110V - 277V
Input Frequency: 60 Hz
Isolation: Class II

Material: Natural Wood Veneer MDF and Acrylic
Weight:

Height Adjustment Limit: 160cm/63in

MAKING ELECTRICAL CONNECTIONS

- ⑥ Pass the power supply cable through the strain relief cone, threaded tube nipple, canopy and crossbar.
- ⑦ Adjust the length of power supply cable by tying a knot to secure it in place.
- ⑧ Connect the electrical supply wires to the junction box in accordance to all applicable local codes, as shown in the diagram.

MOUNTING ON THE FIXTURE

- ⑨ Attach the crossbar to the junction box using the supplied screws.
- ⑩ After electrical connections are made, place excess wire inside of the junction box.
- ⑪ Bring the canopy to the ceiling and secure it by screwing the strain relief cone with the threaded tube nipple into the crossbar.

Turn ON electrical power.

Your luminaire is now ready for use.

ATTENTION!



FAILURE TO COMPLY WITH THESE INSTRUCTIONS MAY CAUSE ACCIDENTS AND LOSS OF PRODUCT WARRANTY.
It is recommended to read these instructions completely and carefully before proceeding.

SAVE THESE INSTRUCTIONS FOR FUTURE REFERENCE.

ACCORD Lighting guarantees coverage against manufacturing defects including electrical components and finishes, for a period of three years, under normal use, from the date of purchase. For warranty service, please contact your local dealer for further instructions. Proof of date of purchase will be required for validation of warranty service.

The responsibility of the manufacturer regarding the product warranty is related to the correct observation of the instructions contained in this manual. The manufacturer is not responsible for any damage to the product caused by accidents, alterations of any kind, improper usage or improper installation. See the website for additional warranty details.

ACCORD Lighting reserves the right to change the dimensions and specifications contained in this manual without prior notice, in accordance with its policy of continuous product improvement. Please, contact the manufacturer if additional information is necessary. The illustrations in this manual are for guidance only and may vary in scale, dimensions and model details.