

Installation Manual

Giorgio Shower Trays

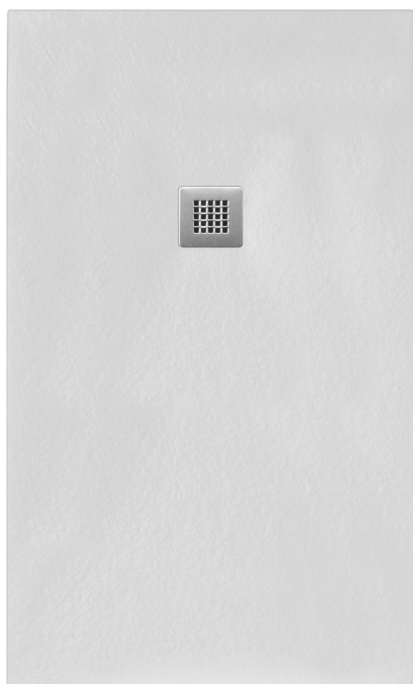

TRGIM
1118

Giorgio Series
Shower Trays

tissino

Designed to Inspire
Made to Experience

Installation Guide

Giorgio Shower Trays

Tools
Required

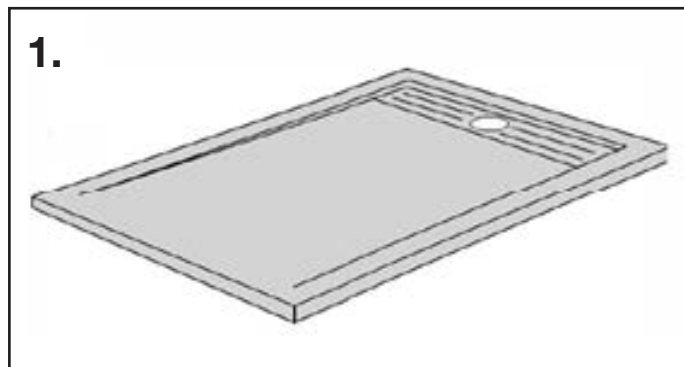

Unpack the tray and check that the product is in perfect condition for installation.

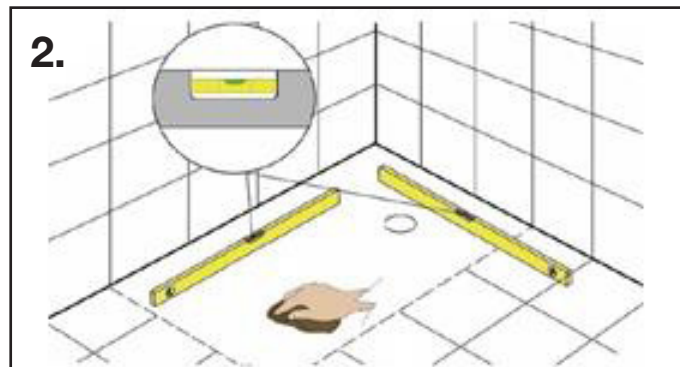

Ensure the tray installation location is firm, flat and clean.

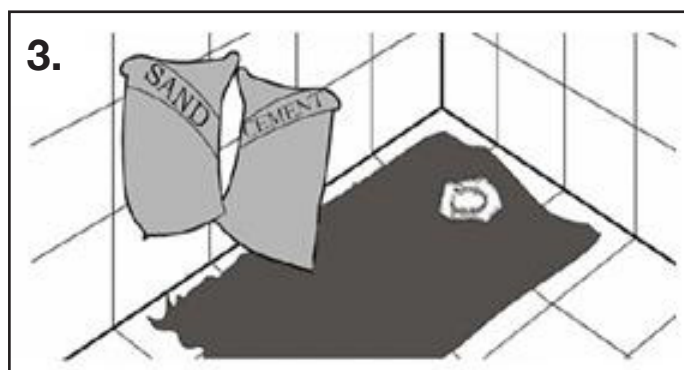

Ensure the installation base is completely solid and level with sand and cement mix. When the base is dry, place the tray with polymer or similar of aqueous base.

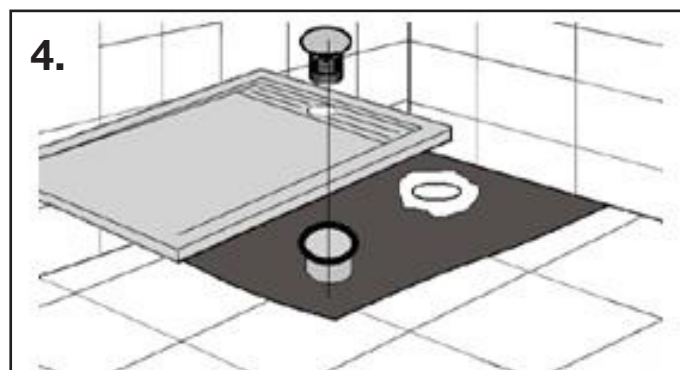

Place the tray in position and install the waste

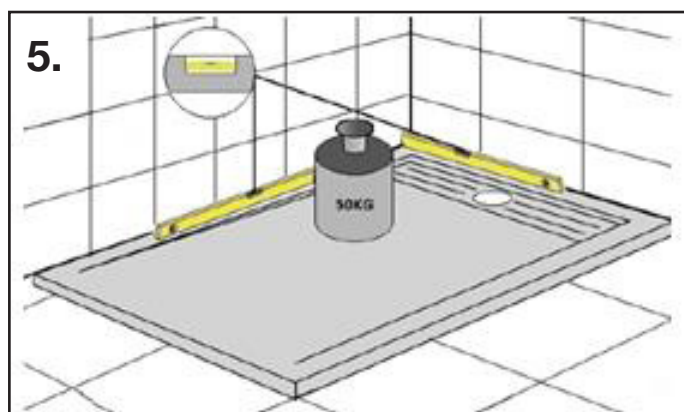

Level the tray ensuring there is sufficient water drainage

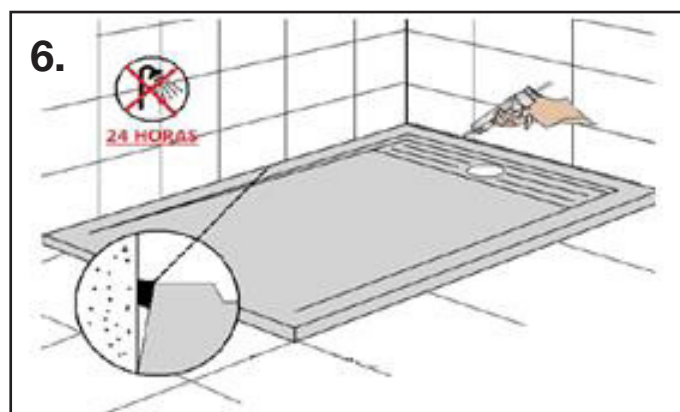

Seal between the tray and the wall with a silicone sealer and leave for 24 hours.

Installation Steps

Giorgio Shower Trays

General notes before installation

- Shower tray must be installed by a qualified installer
- Use caution when unpacking and installing to avoid accident or damage
- Store the shower tray in a horizontal position to avoid damage
- The tray can be cut easily with a circle diamond blade saw

Installation Instructions

- Prepare an installation base ensuring it is level, dry and free of debris. A levelling compound such as a sand and cement mix should be used to ensure the base is completely level
- Ensure enough space is provided in the installation base to install the waste. Ensure the waste does not affect the level of the tray - this is to ensure proper water drainage and to avoid breakages
- Ensure the waste pipe has a sufficient gradient to drain the water
- Generously apply polyurethane glue to the walls that will be in contact with the edges of the tray to avoid water leaking down the side of the tray
- Apply polyurethane glue to the installation base to ensure tray adhesion
- Install the shower tray and waste and ensure there is sufficient water drainage
- Seal between the tray and the wall with silicone
- Leave glue and silicone to dry for 24 hours before use

Cleaning Instructions

- Use a non abrasive sponge or cloth with hot water and soap
- Do not use aggressive products such as alcohol or acid based cleaners
- Do not use a metal or abrasive scrubber
- Do not spill drain cleaner over the shower tray

Guarantee

The guarantee will be invalidated if;

- Tray is damaged by misuse
- Tray is damaged by unsuitable storage
- Tray is damaged by unsuitable cleaning materials
- Tray is installed improperly or by an unskilled installer

Refunds

If the tray has been cut, refunds cannot be accepted

tissino

Designed to Inspire
Made to Experience

T 0345 582 8000
E info@tissino.co.uk
W tissino.co.uk

Lyncastle Road
Appleton Thorn
Warrington WA4 4SN