

W10-00448

D/D EXT FRONT - COMP MOULD - CLASS 2

Stock Number	Description	Quantity
PSV/62/281	SIKA 552 WHITE 600ML SAUSAGE	0.25
PSV/62/283	ADH SIKA 555 600ML SAUSAGE	2.50
PSV/99/728	D/D UPPER EXTERIOR FRONT DOME - CLASS 2	1.00
- PSV/99/899	D/D UPPER EXTERIOR FRONT DOME	1.00
PSV/38/134	FLIFT FRONT LOWER DOME CLASS 2	1.00
- PSV/99/900	DDECK FACELIFT FRONT LOWER DOME	1.00
PSV/38/155	FRONT O/S LIGHT BEZEL COMP MOULD - CL2	1.00
- PSV/125/048	DDECK NEW GEN 2008 FRONT OS LIGHT BEZEL	1.00
PSV/38/158	FRONT N/S LIGHT BEZEL COMP MOULD - CL2	1.00
- PSV/07/924	DDECK NEW GEN 2008 FRONT NS LIGHT BEZEL	1.00
PSV/99/901	FIBREGLASS KIT - COMPRESS FRONT CLASS 2	1.00
- PSV/07/931	N/S F/G LIGHT ATTACH BRK COMP MOULD -CL2	1.00
- - PSV/07/931	08 FRONT N/S F/G LIGHT ATTACH BRACKET	1.00
- PSV/38/149	O/S F/G LIGHT ATTACH BRK COMP MOULD -CL2	1.00
- - PSV/07/932	08 FRONT O/S F/G LIGHT ATTACH BRACKET	1.00
- PSV/133/040	FRONT MID BUMPER COMP MOULD - CLASS 2	1.00
- - PSV/99/902	DDECK NEW GEN 2008 MID BUMPER	1.00
- PSV/133/037	FRT OS CORNER DEFLECTOR COMP MOULD - CL2	1.00
- - PSV/99/903	DDECK NEW GEN 2008 OS CORNER DEFLECTOR	1.00
- PSV/133/036	FRT NS CORNER DEFLECTOR COMP MOULD - CL2	1.00
- - PSV/99/904	DDECK NEW GEN 2008 NS CORNER DEFLECTOR	1.00
- PSV/99/729	O/S CORNER BUMPER COMP MOULD - CLASS 2	1.00
- PSV/99/730	N/S CORNER BUMPER COMP MOULD - CLASS 2	1.00

W10-00448
EXTERIOR FRONT - FIBREGLASS

PSV/99/728
UPPER DECK FRONT DOME

PSV/38/134
LOWER DECK FRONT DOME



PSV/133/037
O/S DEFLECTER

PSV/38/155
O/S LIGHT BEZEL

PSV/99/729
O/S CORNER BUMPER

PSV/133/040
MID BUMPER

PSV/38/158
N/S LIGHT BEZEL

PSV/133/036
N/S DEFLECTER

PSV/99/730
N/S CORNER BUMPER

W11-00458

EXT REAR - FIBREGLASS TYPE APPROVAL

Stock Number	Description	Quantity
PSV/99/731	D/D EU4 EXT REAR DOME - WHITE CLASS 2	1.00
PSV/38/160	D/D N/S CORNER LIGHT BEZEL - WHITE CL2	1.00
PSV/38/161	D/D O/S CORNER LIGHT BEZEL - WHITE CL2	1.00
PSV/54/089	D/D N/S CORNER BUMPER - WHITE CLASS 2	1.00
- PSV/99/732	D/D EU4 N/S CORNER BUMPER	1.00
PSV/54/090	D/D O/S CORNER BUMPER - WHITE CLASS 2	1.00
- PSV/99/733	D/D EU4 O/S CORNER BUMPER	1.00
PSV/38/178	D/D EU4 EXTERIOR BUMPER - WHITE CLASS 2	1.00

W11-00458
EXTERIOR REAR - FIBREGLASS

PSV/99/731
REAR FIBREGLASS DOME

NOTE: PHOTO FOR ILLUSTRATION PURPOSES ONLY



PSV/38/160
N/S REAR LIGHT PANEL

PSV/54/089
N/S REAR CORNER BUMPER

PSV/38/178
MIDDLE BUMPER

PSV/54/090
O/S REAR CORNER BUMPER

PSV/38/161
O/S REAR LIGHT PANEL

W12-00602
SHEETMETAL - ENGINE DOORS - NO INSUL

Stock Number	Description	Quantity
PSV/99/734	B9TL EURO IV OS UPPER DOOR LOCK ANGLE	1.00
- PSV/37/888	ALUM SHT.2500x1250x2.5MM	0.01
PSV/99/735	WATER TRAP DEFLECTOR	1.00
- PSV/65/288	ALUM SHT.2500x1250x1.2mm(18G)	0.01
PSV/99/736	EU4 DD RADIATOR SEALING PANEL - PART 2	1.00
- PSV/62/312	ALUM SHT.2500x1250x2MM (14g.)	0.06
PSV/29/725	EU4 RADIATOR SEAL BOX SECTION - PART 3	1.00
- PSV/37/891	ALUM RHS 25x25x3mm (5M)	0.30
PSV/29/726	RADIATOR SEALING PANEL ATTACH ANGLE	1.00
- PSV/37/888	ALUM SHT.2500x1250x2.5MM	0.00
PSV/99/737	RADIATOR SEALING PANEL ATTACH ANGLE TOP	1.00
- PSV/62/306	ALUM ANGLE 38x38x3mm (5M)	0.00
PSV/99/738	RADIATOR SEALING PANEL - PART 1 NEW	1.00
PSV/62/312	ALUM SHT.2500x1250x2MM (14g.)	0.05
PSV/99/738	EU4 RADIATOR SEALING PANEL PART 4 NEW	1.00
- PSV/62/312	ALUM SHT.2500x1250x2MM (14g.)	1.00
PSV/99/739	B9TL E4 REAR OS SIGHT GLASS BRACKET	1.00
PSV/36/190	LOWER ENGINE DOOR PANEL	1.00
PSV/99/740	PACKER PLATE	1.00
PSV/11/911	PANEL ATTACHMENT BRACKET	2.00
PSV/69/944	PANEL ATTACHMENT BRACKETS	1.00
PSV/13/423	CHECK STRAP - STAPLE 2^	2.00
PSV/13/423	CHECK STRAP - STAPLE 2^	2.00
PSV/12/949	CAB DOOR CHECKSTRAP 48mm x 134mm BLACK	1.00
PSV/41/389	DETACHABLE CHECK STRAP ASSEMBLY	1.00
- PSV/41/387	DETACHABLE CHECK STRAP	1.00
- PSV/41/388	DETACHABLE CHECK STRAP LATCH	1.00
PSV/44/757	RUBBER - BULBTITE SVF 20	2.20
PSV/99/741	ENGINE DOOR M/SWITCH BRACKET	1.00
PSV/99/742	SWITCH PLATE	1.00
PSV/57/458	ENGINE DOOR KIT - N/S REAR	1.00
- PSV/54/078	B9TL EURO IV NS DOOR LOUVRE TOP ANGLE	1.00
- PSV/54/076	B9TL EURO IV NS DOOR LOUVRE VERT ANGLE	2.00
PSV/54/075	B9TL EURO IV NS DOOR LOUVRE BOTTOM ANGLE	1.00
- PSV/54/071	B9TL EURO IV NS DOOR FRAME LONG VERT BOX	1.00
- PSV/54/072	B9TL EURO IV NS DOOR SOUTHCO LOCK ANGLE	1.00
- PSV/54/077	B9TL EURO IV NS DOOR LOUVRE	13.00
PSV/54/079	B9TL E4 NS ENGINE DOOR ANGLE KEEPER	1.00
-PSV/135/061	ENGINE DOOR PANEL	1.00
- PSV/99/743	ENGINE DOOR TUBE	1.00
- PSV/99/744	ENGINE DOOR TUBE	1.00
-PSV/99/745	ENGINE DOOR TUBE	1.00
- PSV/99/746	ENGINE DOOR TUBE	1.00
- PSV/99/747	ENGINE DOOR TUBE	1.00
- PSV/99/748	ENGINE DOOR PLATE	2.00
- PSV/99/749	WATER TRAP ASSEMBLY	1.00
- PSV/36/191	ENGINE DOOR BKT	1.00
- PSV/10/937	ALUM ACCESSORY TOGGLE M8	1.00

W12-00602

SHEETMETAL - ENGINE DOORS - NO INSUL

Stock Number	Description	Quantity
- PSV/99/750	DRIP GUARD	1.00
- PSV/99/426	STAINLESS STEEL HINGE 55mm	1.00
PSV/11/499	STAINLESS STEEL HINGE 61mm	1.00
- PSV/12/307	SEALED LEVER LATCH - C/W 'T' KEY LOCK	2.00
- PSV/21/122	M8X15 TORX BUTTON SCREW PATCHED	1.00
- PSV/99/751	M6 X 45MM SKT CSK SCREW	4.00
-PSV/60/161	M6 SELF FINISH NYLOC NUT	4.00
- PSV/43/704	1/4in.FLAT STEEL WASHER	4.00
PSV/135/047	B9TL REAR O/S RADIATOR DOOR	1.00
- PSV/54/148	B9TL RADIATOR DOOR LOUVRE	18.00
-PSV/54/139	B9TL RADIATOR DOOR VERTICAL ANGLE	1.00
- PSV/54/137	RAD DOOR FRAME - BOTTOM HORIZONTAL BOX	1.00
- PSV/54/136	RAD DOOR FRAME - BOX SECTION	1.00
- PSV/54/153	RAD DOOR FRAME - BOX SECTION	1.00
- PSV/54/138	B9TL E4 OS ENGINE DOOR LOUVRE SUPPORT AN	2.00
- PSV/54/146	B9TL RADIATOR DOOR STRUCTURAL LOUVRE	1.00
- PSV/54/133	B9TL EURO 4 RAD DOOR VERTICAL BOX	1.00
- PSV/54/152	OFFSIDE ENGINE DOOR SKIN STIFFENER	1.00
- PSV/99/752	B9TL RADIATOR DOOR TOP HORIZONTAL ANGLE	1.00
- PSV/99/753	B9TL ENG DR FLYSCREEN ANGLE	2.00
- PSV/99/754	PACKING STRIP REAR ENG DR	2.00
- PSV/99/755	REAR ENGINE DOOR LOWER LOUVRE GROUND	1.00
- PSV/99/756	VOLVO FLYSCREEN FRAME ASSEMBLY	1.00
- PSV/99/757	FLY SCREEN SUPPORT	1.00
- PSV/99/758	B9TL RAD DOOR SKIN	1.00
- PSV/13/393	FUEL FILLER FLAP - SMALL	1.00
- PSV/54/142	HINGE-EPOXY BLACK 50 X	3.00
- PSV/12/307	SEALED LEVER LATCH - C/W 'T' KEY LOCK	2.00
- PSV/11/502	FAST LEAD SCREW - LARGE SIZE	2.00
- PSV/12/999	STAINLESS STEEL RECEPTABLE RIVET TYPE	2.00
- PSV/54/144	LARGE STAINLESS STEEL RETAINER	2.00
- PSV/125/085	B9TL E4 O/S RAD DOOR HINGE	2.00

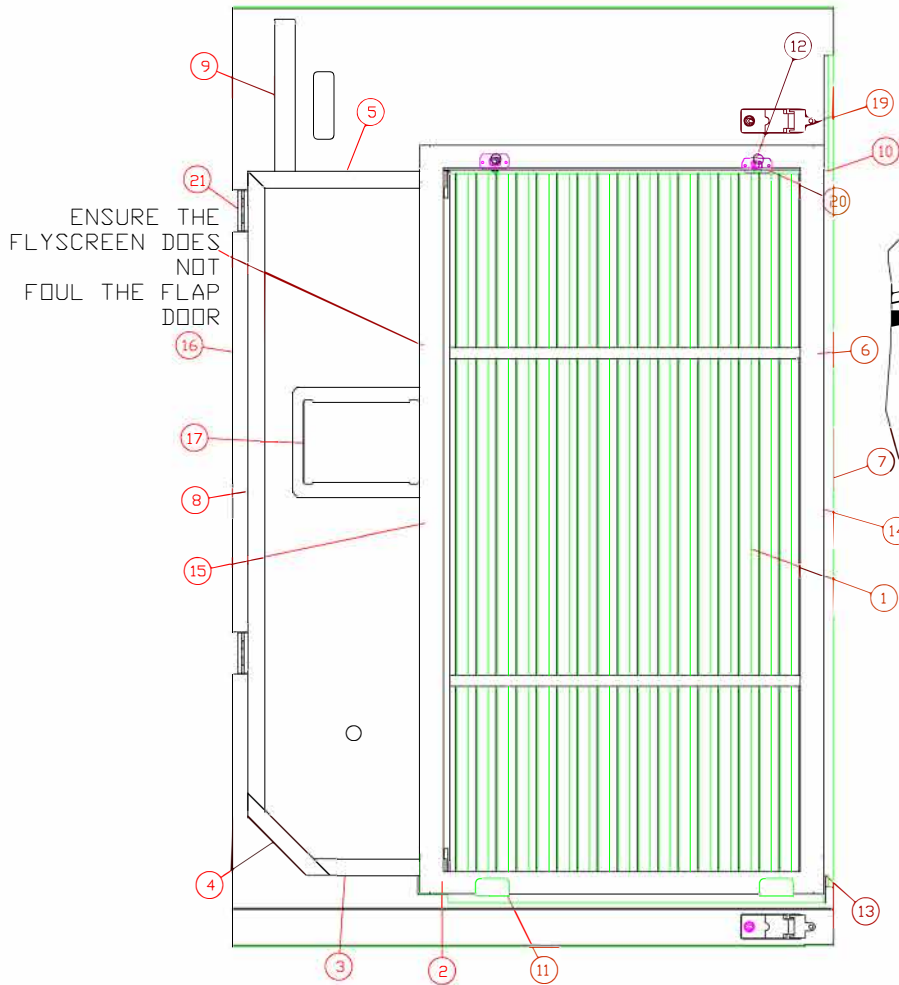

ENSURE THE FLYSCREEN DOES NOT FOUL THE FLAP DOOR

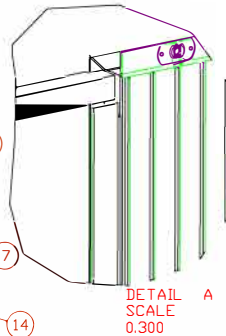
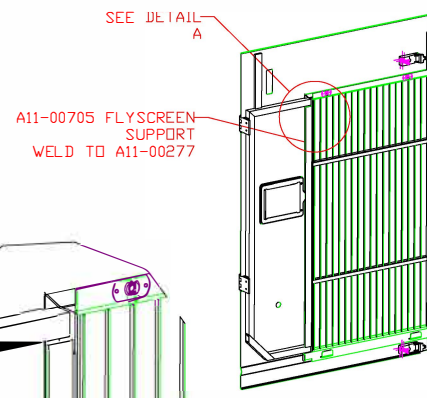

FILLET WELD TO FRAME AT THIS EDGE AND BOND TO PANEL

NOTE: A11-00482 TO BE LOCATED ON THIS FACE OF ANGLE BETWEEN ANGLE AND FIXTURE (TO ALLOW FLYSCREEN TO SIT AS TIGHT AS POSSIBLE TO DOOR AT TOP END)

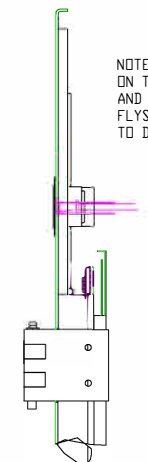

PARTIAL SIDE VIEW

Index	Part No.	Description	Qty
1	PSV/54/148	B9TL EURO IV RAD LOUVRE	18
2	PSV/54/139	B9TL EURO IV RAD DOOR VERTICAL ANGLE	1
3	PSV/54/137	B9TL EURO IV RAD DOOR BTM HORIZ BOX	1
4	PSV/54/136	B9TL EURO IV RAD DOOR MITRED BOX	1
5	PSV/54/153	B9TL EURO IV RAD DOOR TOP HORIZ BOX	1
6	PSV/54/138	B9TL EURO IV RAD LOUVRE SUPPORT ANGLE	2
7	PSV/54/146	B9TL EURO IV RAD STRUCTURAL LOUVRE	1
8	PSV/54/133	B9TL EURO 4 RAD DOOR VERTICAL BOX	1
9	PSV/54/152	OFFSIDE ENGINE DOOR SKIN STIFFENER	1
10	PSV/99/752	RAD DOOR TOP ANGLE	1
11	PSV/99/753	Rear Engine Door Flyscreen Angle	2
12	PSV/99/754	PACKING STRIP REAR ENG DOOR - B9TL	2
13	PSV/99/755	RAD DOOR BOTTOM ANGLE	1
14	PSV/99/756	VOLVO Flyscreen	1
15	PSV/99/757	FLY SCREEN SUPPORT ANGLE	1
16	PSV/99/758	B9TL D/S RAD DOOR FLAT SKIN	1
17	PSV/13/393	MODIFIED SMALL FILLER FLAP	1
18	PSV/12/307	SOUTHCO LATCH 'T' KEY LOCK	2
19	PSV/12/999	SOUTHCO SS RECEPTACLE	2
20	PSV/125/085	B9TL EURO IV D/S RAD DOOR HINGE	2

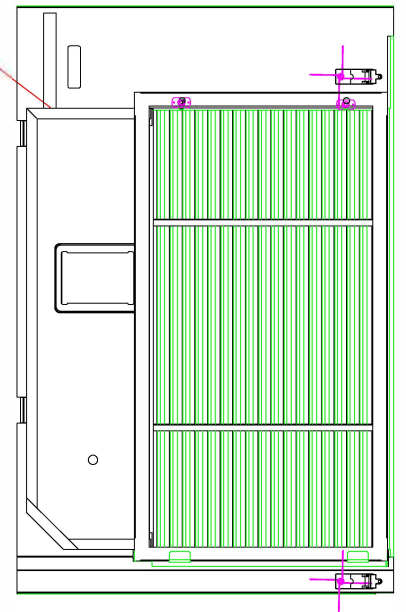

ALL AREAS OF THE STAINLESS STEEL VOLVO FLYSCREEN AND SDK-00146 DOOR WHICH COME INTO CONTACT WITH EACH OTHER MUST BE PAINTED WITH DURALAC PAINT TO STOP CORROSION. PLEASE USE THE WORK INSTRUCTION WHICH STATES IN DETAIL ALL PAINTED AREAS.

SHEETMETAL - O/S ENGINE DOOR

W12-00602 - SDK-00146

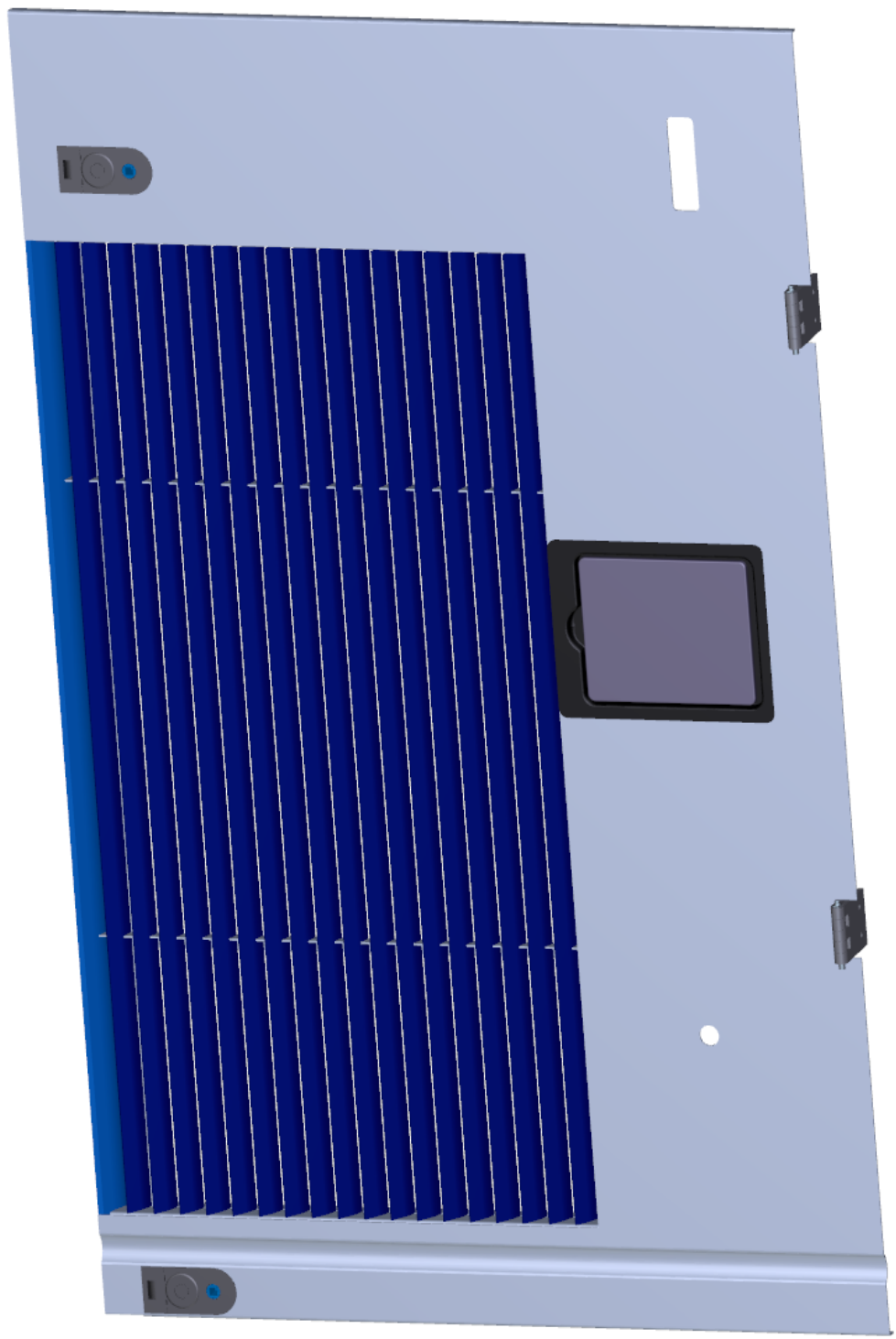

SHEETMETAL - N/S ENGINE DOOR

W12-00602 - SDK-00131

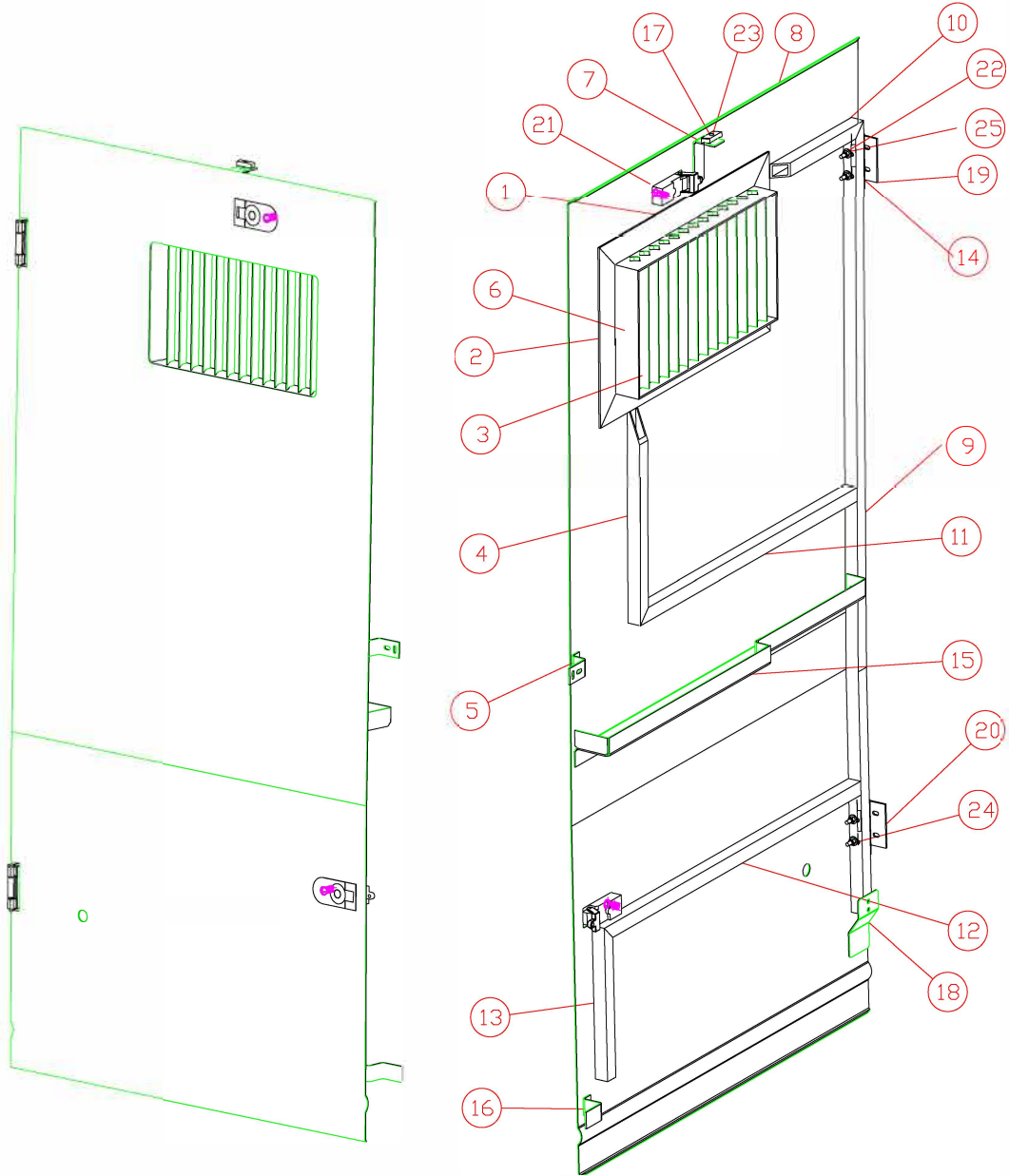

Index	Part Number	Compnt Type	Description	Qty
1	PSV/54/078	PART	B9TL EURO4 NS DOOR LOUVRE ANGLE	1
2	PSV/54/076	PART	B9TL EURO4 NS DOOR LOUVRE ANGLE	2
3	PSV/54/075	PART	B9TL EURO4 NS DOOR LOUVRE ANGLE	1
4	PSV/54/071	PART	B9TL EURO4 NS DOOR FRAME BOX SEC	1
5	PSV/54/072	PART	SOUTHCO LATCH ANGLE	1
6	PSV/54/077	PART	AIR INTAKE GRILLE LAMELLA (LOUVRE)	13
7	PSV/54/079	PART	SOUTHCO LATCH ANGLE	1
8	PSV/135/061	PART	B9TL E4 REAR NS LOWER DOOR PANEL	1
9	PSV/99/743	PART	ENGINE DOOR TUBE	1
10	PSV/99/744	PART	ENGINE DOOR TUBE	1
11	PSV/99/745	PART	ENGINE DOOR TUBE	1
12	PSV/99/746	PART	ENGINE DOOR TUBE	1
13	PSV/99/747	PART	ENGINE DOOR TUBE	1
14	PSV/99/748	PART	ENGINE DOOR PLATE	2
15	PSV/99/749	ASSEMBLY	WATER TRAP ASSEMBLY	1
16	PSV/36/191	PART	ENGINE DOOR BKT	1
17	PSV/110/937	PART	M8 TOGGLE	1
18	PSV/99/750	PART	DRIP GUARD	1
19	PSV/99/426	ASSEMBLY	TBD	1
20	PSV/11/499	ASSEMBLY	TBD	1
21	PSV/12/307	ASSEMBLY	SOUTHCO LATCH 'T' KEY LOCK	2
22	PSV/67/720	PART	M6 X 50 CAD BOLT	4
23	PSV/21/122	PART	M8X15 TORX BUTTON SCREW PATCHED	1
24	PSV/60/161	PART	M6 SELF FINISH HEX NYLOC NUT	4
25	PSV/60/164	PART	M6 BRIGHT STEEL WASHER	4

Parts A11-00333, A11-00367 and A11-00747 to be supplied loose with the door, and will be fitted by our production line.

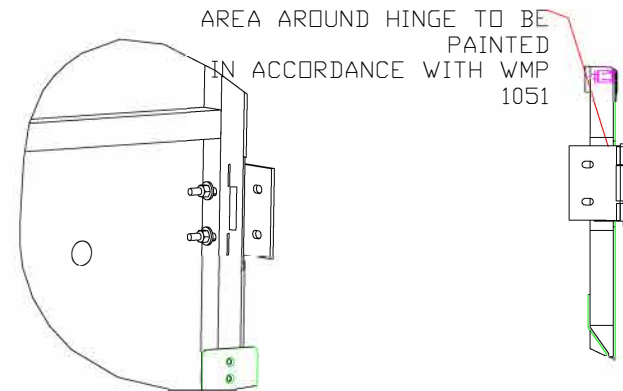

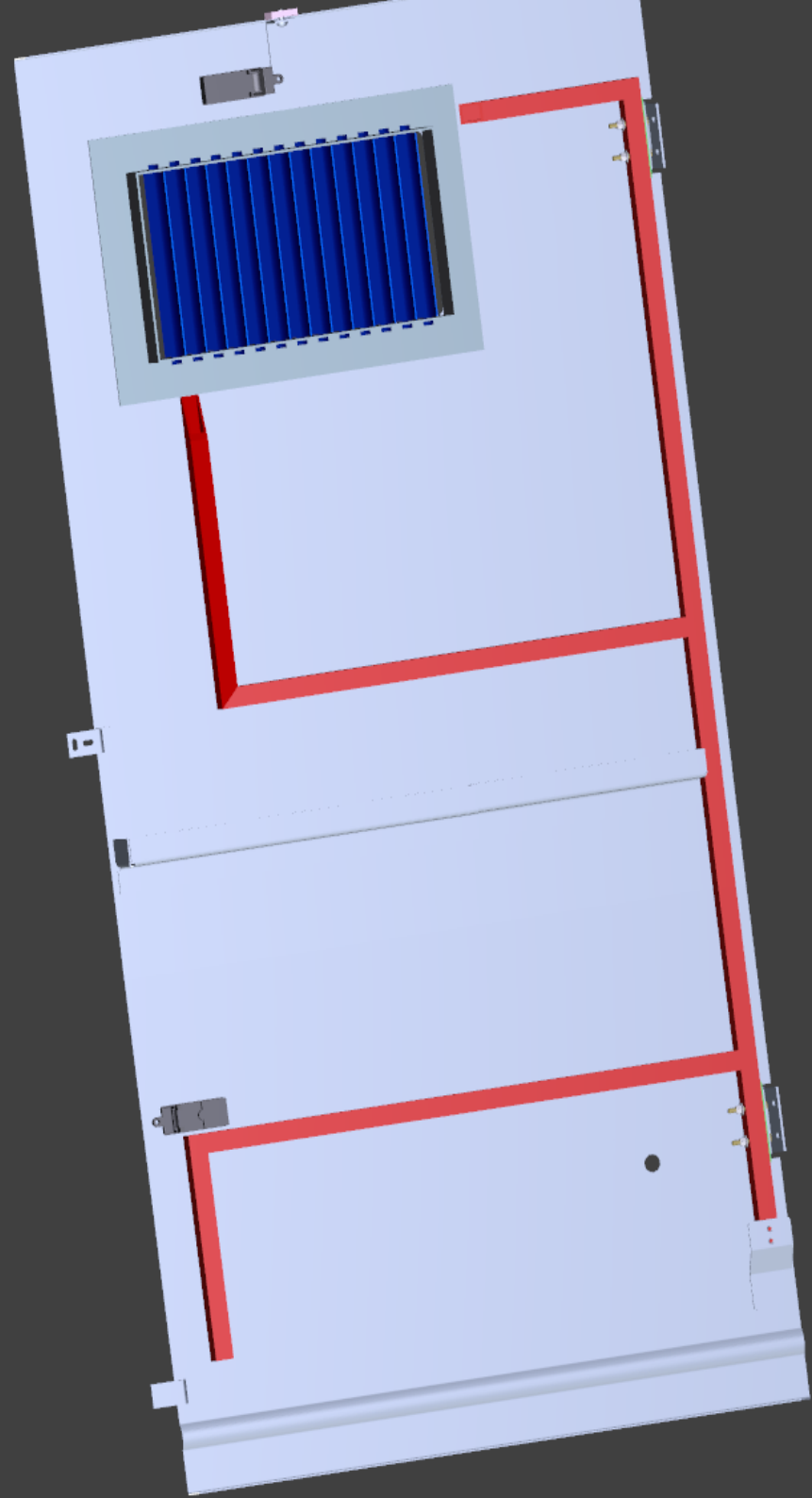

W12-00618

SHEETMETAL - BASIC ASSEMBLY 10.5M B9TL

Stock Number	Description	Quantity
PSV/36/181	B9TL RADIATOR LOWER PANEL	1.00
PSV/11/121	B9TL E4 OS LOWER PANEL ATTACH BRACKET	1.00
PSV/21/129	B9TL E4 OS LOWER PANEL ATTACH BRACKET	1.00
PSV/21/130	B9TL E4 LOWER REAR OS PANL BRACKET SUPPT	1.00
PSV/12/307	SEALED LEVER LATCH - C/W 'T' KEY LOCK	2.00
PSV/11/362	M8 PILLAR PACKER TOGGLE	22.00
PSV/99/366	AD-BLUE FILLER SUPPORT BRACKET	1.00
PSV/99/367	AD-BLUE FILLER SUPPORT BRACKET	1.00
PSV/51/145	AD-BLUE FILLER DRIP TRAY ASSEMBLY	1.00
- PSV/64/370	UREA FILL SHROUD 10mm STAINLESS ST FILL	1.00
- PSV/99/368	AD-BLUE FILLER DRIP TRAY PART 1	1.00
PSV/56/585	RUBBER BUNG DOOR STOP	2.00
PSV/99/842	B9TL 10.5 SHEETMETAL KIT - SINGLE DOOR	1.00
- PSV/135/032	D DECK O/S SIDE PANEL - 1407mm	2.00
- PSV/54/096	1387mm D DECK CAPPING ABOVE BATT PANEL	1.00
- PSV/135/030	N/S REAR W/ARCH PANEL - 695mm (NO BEAD)	1.00
- PSV/135/039	O/S REAR W/ARCH PANEL - 693mm (NO BEAD)	1.00
-PSV/135/026	N/S FRONT W/ARCH PANEL - ADD FIXING	1.00
- -PSV/54/038	N/S FRONT WHEELARCH PANEL	1.00
- -PSV/13/916	ALUM ACCESSY BALLY RUBBER	1.00
- -PSV/71/463	PANEL STRENGTHENING RIB	1.00
- PSV/135/044	O/S FRONT W/ARCH PANEL - ADD FIXING	1.00
- PSV/54/039	O/S FRONT WHEELARCH PANEL	1.00
- PSV/13/916	ALUM ACCESSY BALLY RUBBER	1.00
- PSV/71/463	PANEL STRENGTHENING RIB	1.00
- PSV/54/043	DOUBLE DECK N/S REAR WHEELARCH PANEL	1.00
- PSV/135/059	B9TL EU4 O/S REAR WHEELARCH PANEL	1.00
-PSV/54/047	B9TL N/S REAR SHEETMETAL PANEL	1.00
- PSV/54/093	B9TL O/S REAR SHEETMETAL PANEL	1.00
- PSV/36/678	O/S FRONT W/ARCH PANEL ASM	1.00
- PSV/36/629	W/ARCH SHEETMETAL PANEL	1.00
- -PSV/67/402	FRONT WHEEL ARCH STRENGTHENER PLATE	1.00
- PSV/36/679	N/S FRONT W/ARCH PANEL ASM	1.00
- - PSV/36/630	W/ARCH SHEETMETAL PANEL	1.00
- -PSV/67/402	FRONT WHEEL ARCH STRENGTHENER PLATE	1.00
- PSV/135/056	AD BLUE FILL SHEETMETAL PANEL ASSY	1.00
- PSV/135/055	SIDE SHEETMETAL PANEL - B9TL 10.5	1.00
- PSV/36/684	SIDE SHEETMETAL PANEL - B9TL 10.5	1.00
- PSV/135/058	SIDE SHEETMETAL PANEL - B9TL 10.5	1.00
- PSV/13/916	ALUM ACCESSY BALLY RUBBER	15.32
-PSV/54/095	HINGE PANEL STRIKER PLATE	1.00
- PSV/11/260	PROTEX EXTENDED STRIKER	3.00
- PSV/135/063	B9TL EU4 O/S FRONT HINGED PANEL	1.00
- -PSV/36/462	B9TL EU4 BATTERY PANEL	1.00
- PSV/99/385	BATTERY PANEL STRUT BRACKET	1.00
- -PSV/60/186	DOOR STRUT BRACKET	1.00
- PSV/10/899	STAY - TELESCOPIC HEAVY DUTY	1.00

W12-00618

SHEETMETAL - BASIC ASSEMBLY 10.5M B9TL

Stock Number	Description	Quantity
- - PSV/62/953	M6x30 CAD ENG.BOLT	1.00
- -PSV/67/720	M6x50 CAD ENG.BOLT	1.00
- PSV/63/032	M6 SELF FINISH HEX NUT	2.00
- - PSV/60/161	M6 SELF FINISH NYLOC NUT	2.00
- - PSV/43/704	1/4in.FLAT STEEL WASHER	7.00
- - PSV/99/386	HINGE BAR SECTION - BATTERY DOOR	1.00
- - PSV/99/387	HINGE BAR SECTION - BATTERY DOOR	1.00
- PSV/11/142	SHEETMETAL BRACKET	8.00
- PSV/21/140	B9TL EURO4 REAR SHEETMETAL PANEL BRACKET	2.00
-PSV/11/696	PANEL ATTACHMENT BRACKET	15.00
- PSV/21/132	WHEELARCH PANEL BRACKET ASSEMBLY	4.00
- PSV/11/487	PANEL ATTACHMENT BRACKET - MILLED END	1.00

***NB:** HINGED PANELS HAVE HEAVY DUTY STAYS (DES-00041) AND 2 PSV/12/307 SEALED LEVER LATCHES
 BLACK SIKA 260 (ADA-00027) IS USED ON PANELS WHICH HAVE STRENGTHENERS
 BETASEAL (ADA-00006) IS USED TO SEAL THE RADIATOR PANEL
 IF A PANEL IS REMOVED, BE SURE TO USE NEW M8x20 BOLTS (FBM-02598) ON RE-ASSEMBLY
 IF REPLACING RADIATOR MESH, BE SURE TO USE GENUINE WRIGHTS PARTS FOR CORRECT AIR FLOW

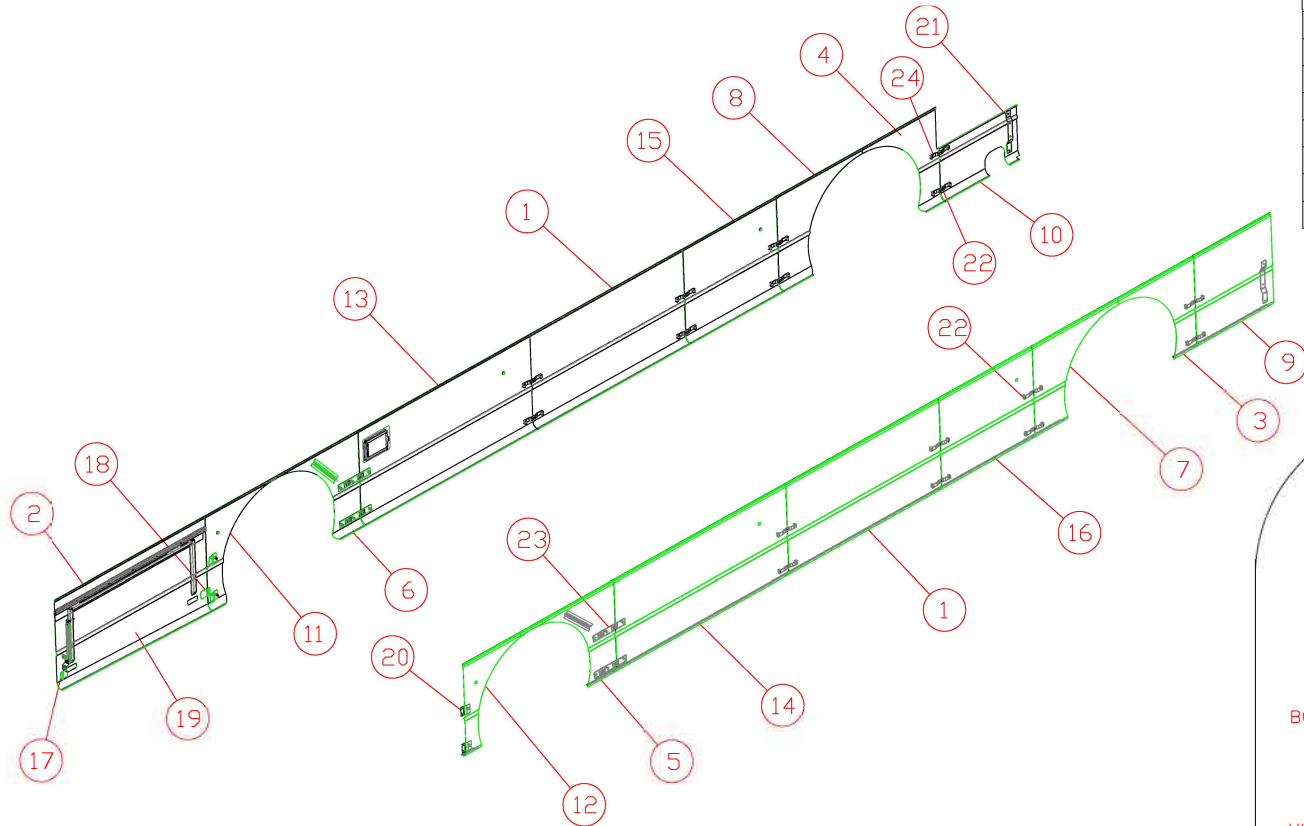
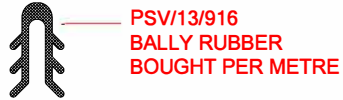
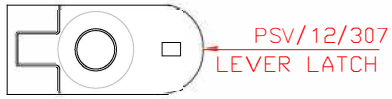

Index	Part No.	Description	Qty
1	PSV/135/032	N/S SIDE PANEL	2
2	PSV/54/096	CAPPING FOR HINGED PANEL	1
3	PSV/135/030	N/S SIDE PANEL	1
4	PSV/135/039	N/S SIDE PANEL	1
5	PSV/135/026	WHEEL ARCH PANEL ASSEMBLY	1
6	PSV/135/026	WHEEL ARCH PANEL ASSEMBLY	1
7	PSV/54/043	N/S SIDE PANEL	1
8	PSV/135/059	N/S SIDE PANEL	1
9	PSV/54/047	B9TL N/S REAR SHEETMETAL PANEL	1
10	PSV/54/093	B9TL D/S REAR SHEETMETAL PANEL	1
11	PSV/36/678	D/S FRONT WHEEL ARCH ASSEMBLY	1
12	PSV/36/679	N/S FRONT WHEEL ARCH ASSEMBLY	1
13	PSV/135/056	D/S AD BLUE SHEETMETAL PANEL ASSY	1
14	PSV/135/055	SHEET METAL PANEL - 1582MM	1
15	PSV/36/684	D/S SHEETMETAL PANEL	1
16	PSV/135/058	N/S SHEETMETAL PANEL	1
17	PSV/54/095	HINGE PANEL STRIKER PLATE	1
18	PSV/11/260	PROTEX EXTENDED STRIKER	1
19	PSV/135/063	B9TL EU4 D/S FRONT HINGED PANEL	1
20	PSV/11/142	SIDE ATTACHMENT BRACKET	4
21	PSV/21/140	B9TL REAR SHEETMETAL PANEL BKT	2
22	PSV/11/696	SIDE PANEL ATT BRACKET	15
23	PSV/21/132	Panel Attachment Bracket Assembly	4
24	PSV/11/487	PANEL ATTACHMENT BRACKET	1

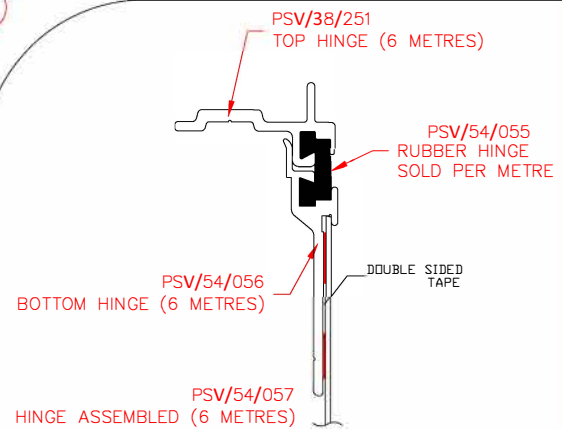

SHEETMETAL - BASIC ASSEMBLY

W12-00618

ALLOY
PILLAR TRIMS

PSV/37/872
PILLAR TRIM - 90mm WIDE

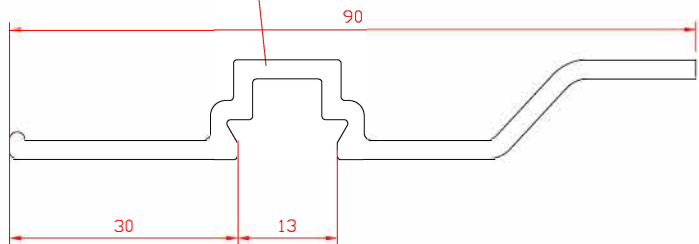

PSV/61/286
PILLAR TRIM - 80mm WIDE

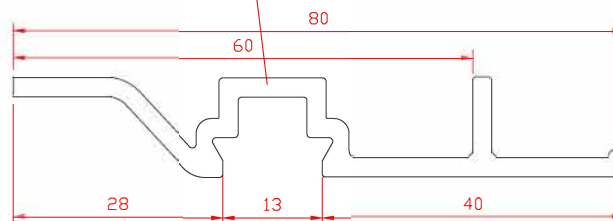

PSV/99/388
PILLAR TRIM INFILL



PSV/61/285
PILLAR TRIM - 74mm WIDE

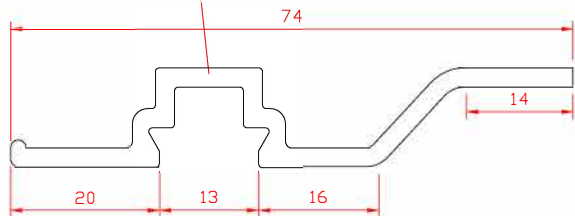

PSV/37/870
PILLAR TRIM - 60mm WIDE

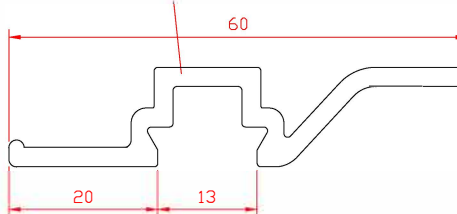

PSV/99/389
PILLAR TRIM - 52mm WIDE

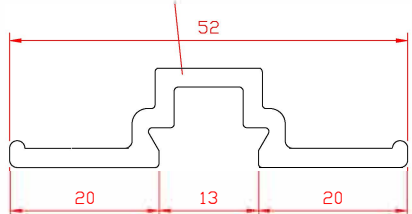

PSV/37/871
PILLAR TRIM - 60mm WIDE

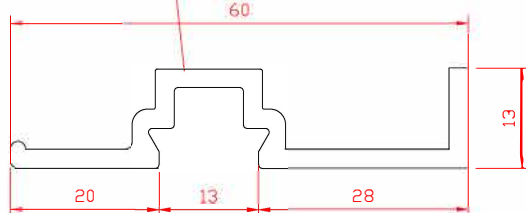

Top face of
extrusion is visual

PSV/99/843
PSV/99/391

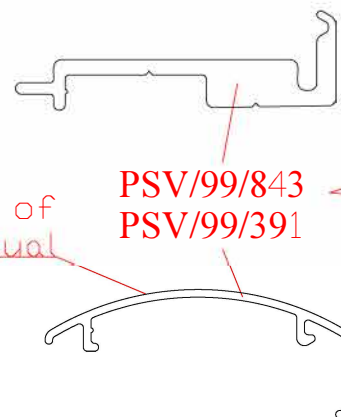

These run the whole
length of the bus.

