

PRODUCT MANUAL

raintap

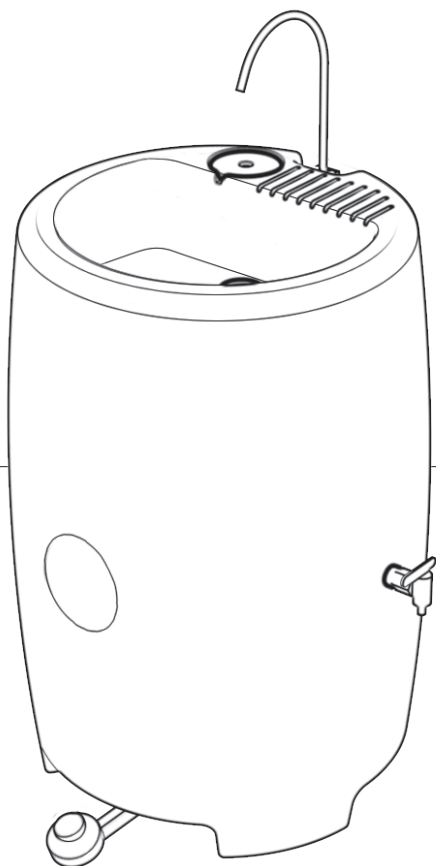

WARNING

- DO NOT DRINK RAINWATER.**
- CHECK WATER QUALITY BEFORE USE.**
- CLEAN YOUR RAIN TAP WHEN NEEDED. CHECK MONTHLY.**
- CLEAN YOUR RAIN TAP WITH A CLOTH AND MILD DETERGENT.**
- TAKE ACTION WHEN TEMPERATURES ARE BELOW 0 DEGREES:**
 - MAKE SURE THERE'S NO WATER IN THE HOSES OR PUMP.**
 - DRAIN AND DISCONNECT THE BARREL FROM THE RAINPIPE DURING EXTREME COLD.**

CHECK THE LATEST VERSION ON WWW.RAINTAP.EU

BEFORE YOU START

Persons

One person

Parts

Single Tap: 22

Tools

Flat-head screwdriver (6mm)



Phillips-head screwdriver (5mm)



Wrench (8mm)

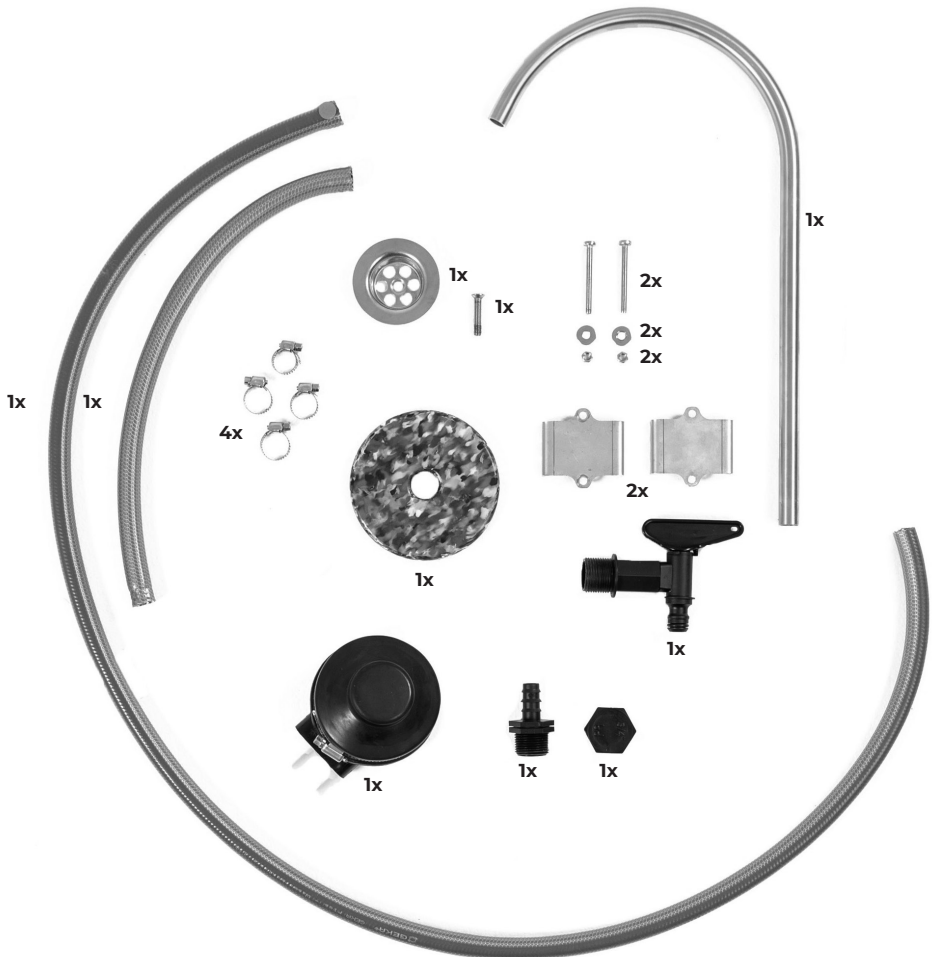

1. PUMP CONNECTION

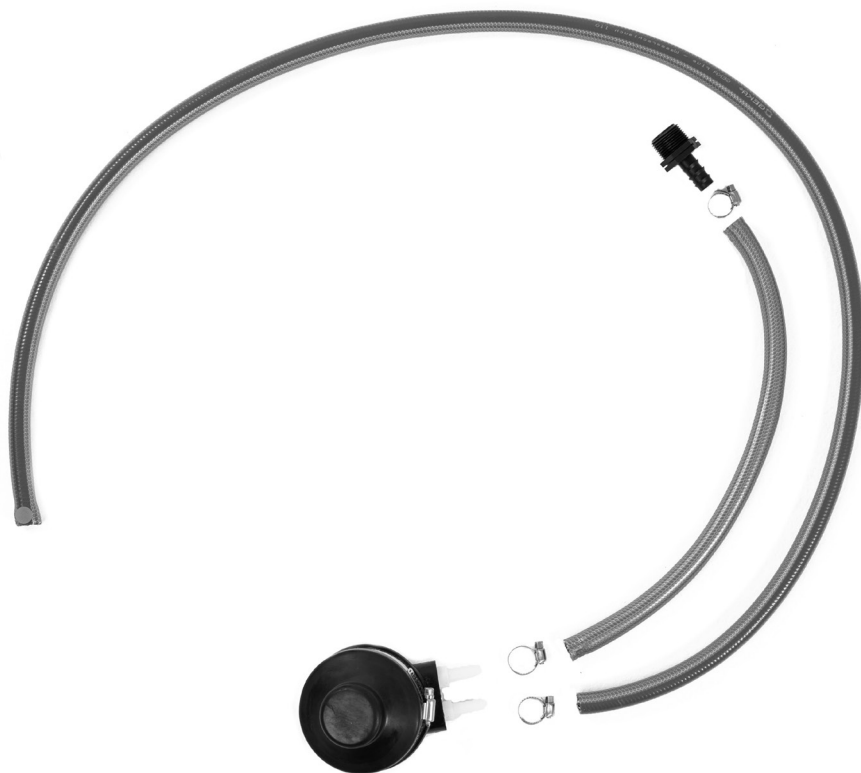

Step 1

– Lay the RainTap on its back.

*Use a soft ground surface to avoid damage

Step 2

– Turn the hose fitting in a clockwise direction in the bottom screw thread.



1



2

Step 3

– Slide the hose clamp over the small hose.

Step 4

– Connect the small hose to the tap by pushing and twisting the hose.



3



4

Step 5

– Screw the hose clamp tightly.

* Flat-head screwdriver

Pay attention!

Make sure the hose is not weirdly twisted.



5



Step 6

- Lay the long hose next to the barrel and make sure the hose lays in the position like shown in the image.

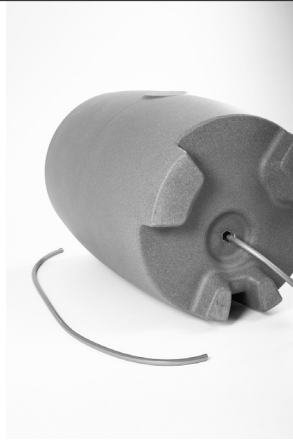

6



7

Step 7

- Lift the barrel and put the barrel over the longer hose.
- Make sure the widened, marked end of the long hose points to the top of the tank.

Check

- The small and long hose should not be twisted.

Step 8

- Take the **small** hose and slide the second hose clamp over the hose.



8

Step 9

- Face the footpump horizontal.
- Push the small hose over the pump connector with the arrow facing inward.

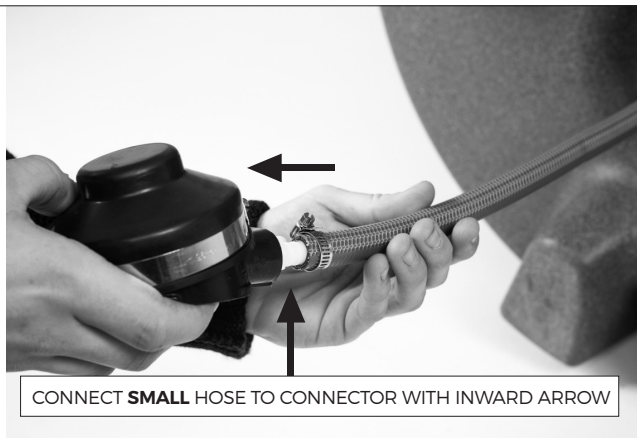

9

Step 10

- Screw the hose clamp tightly.

* Flat-head screwdriver

Pay attention!

- All hose clamps are positioned about 1 cm from the end of the hose. This prevents the hose from leaking.

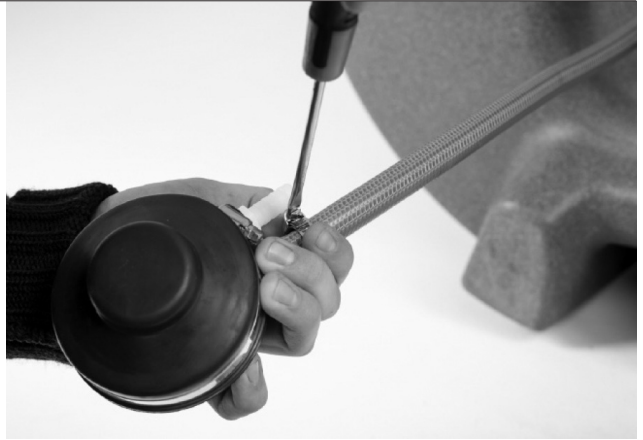

10

Step 11

- Push the third hose clamp over the long hose .



11

Pay attention!

- The arrow on the side of the pump is identical to the image on the right.

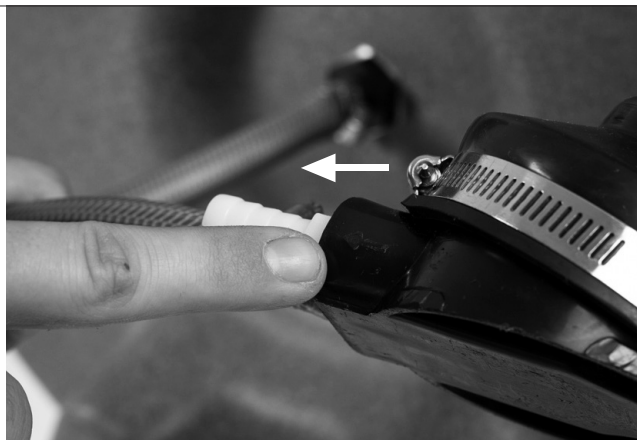

Step 12

- Push the longer hose over the exit connector (outward pointing arrow) of the pump.



12

Step 13

- Screw the third hose clamp tight.

* Flat-head screwdriver

Pay attention!

- Both hoses should not be twisted and look similar to the image.
- Hose clamps are positioned identical to the image.

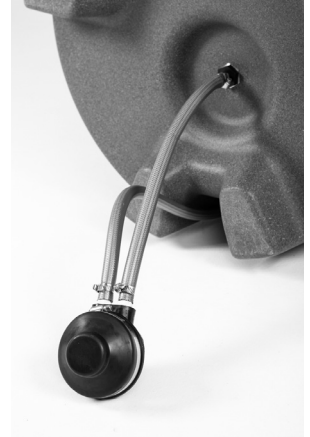

13

Step 14

- Lift the barrel back up to its legs.

Check

- The footpump has space to move from left to right.



14

2. TAP-HOSE CONNECTION

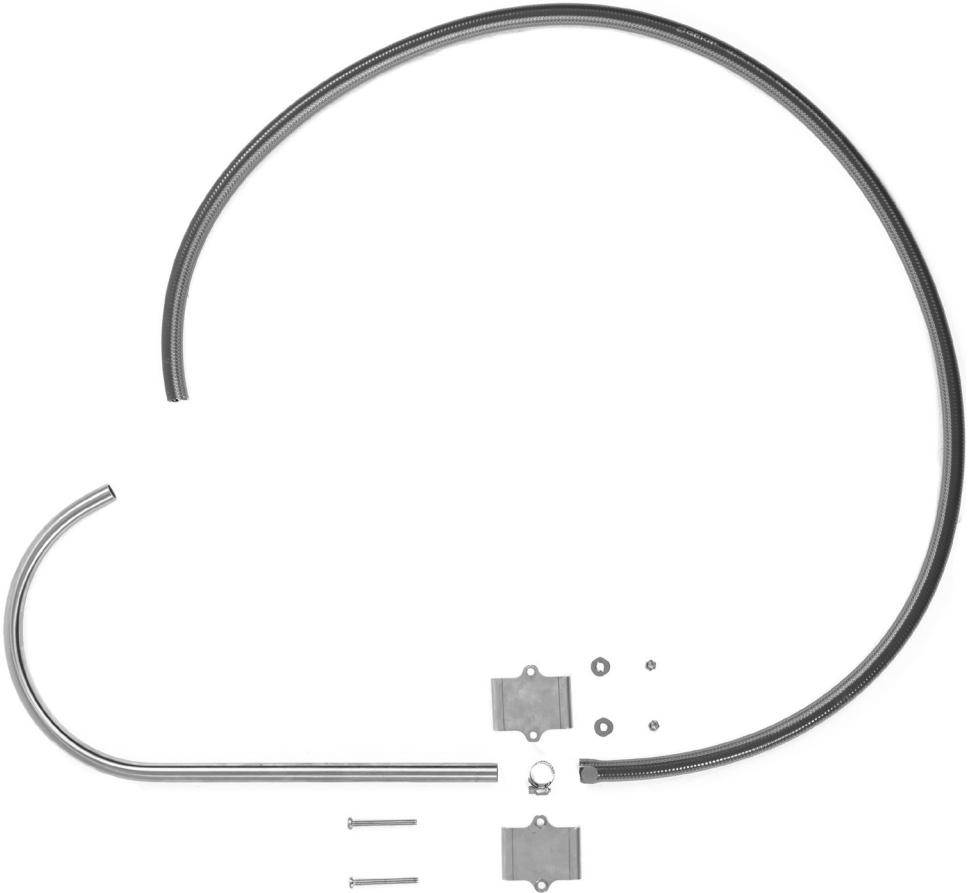

Step 15

- Put the long bolts (x2) through the stainless steel plates (x2). This creates the tap clamp.

Step 16

- Screw the tap clamp loosely to the pre-drilled holes on the back of the barrel.

*Phillips-head screwdriver



15



16

Step 17

- Slide the tap through the middle hole and level the tap to the height that you prefer.

Step 18

- Screw the tap clamp tight.
- *Phillips-head screwdriver



17



18

Check

- Take the small rings (x2) and nuts (x2).

*Both of the follow steps can only be done through the hole on top.



Step 19

- Put the rings over the two long bolts against the inside surface of the barrel.
- Take the nuts and twist these over the long bolts with the wrench.

* wrench

Step 20

- Push the fourth hose clamp over the long tube.

* The marked side of the hose should be connected.



15



16

Step 21

- Connect the long hose to the tap by pushing and twisting the hose.

Step 22

- Screw the hose clamp tight.

* Flat-head screwdriver



17



18

3. THE FINAL TOUCH



Step 23

- Twist the cap to the thread hole located on the bottom back left (leg).

*Use tools if needed.

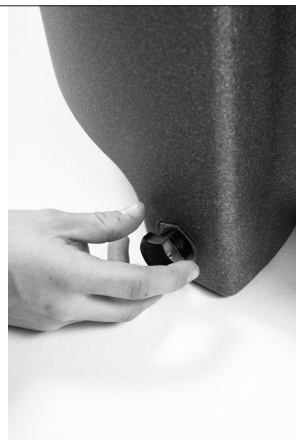

23

**Step 24**

- Twist the gardentap to the thread hole located on the side/middle of the barrel.

Step 25

- Position the gardentap horizontally.



24



25

Step 26

- Put the small bolt through the hole of the sink strainer.

Step 27

- Screw the sink strainer to the pre-drilled hole in the sink on top of the barrel.

* Phillips-head screwdriver



26



27

Step 28

- Put the coloured disk on the big hole on top of the barrel.

You are set and ready to install your Raintap to your rainpipe. Check our website for the installation video's.

Have fun!



28

WARNING

- DO NOT DRINK RAINWATER.
- CHECK WATER QUALITY BEFORE USE.
- CLEAN YOUR RAINTAP WHEN NEEDED. CHECK MONTHLY.
- CLEAN YOUR RAINTAP WITH A CLOTH AND MILD DETERGENT.
- TAKE ACTION WHEN TEMPERATURES ARE BELOW 0 DEGREES:
 - MAKE SURE THERE'S NO WATER IN THE HOSES OR PUMP.
 - DRAIN AND DISCONNECT THE BARREL FROM THE RAINPIPE DURING EXTREME COLD.

CHECK THE LATEST VERSION ON WWW.RAINTAP.EU

**share your
installed Raintap!
#raintap
#studioflorisschoonderbeek**

Contact

- Address

De Kleine Campus
Statenlaan 8
6828 WE Arnhem
The Netherlands

- E-mail

info@raintap.eu

- Instagram: [raintap_](#)

- For more tips & tricks check our website

www.raintap.eu