

STEALTHPIVOT

By PortaPivot

TECHNICAL DOCUMENTATION



01/ Stealthpivot NL & XL



STEALTHPIVOT NL

- ▶ For doors up to 1250 mm wide
- ▶ Max. weight 75 kg (165 lbs)
- ▶ Maintenance free
- ▶ Silent 90° hold function
- ▶ 90° stop or 360° rotation

STEALTHPIVOT XL

- ▶ For doors up to 2250 mm wide
- ▶ Max. weight 150 kg (330 lbs)
- ▶ Maintenance free
- ▶ Silent 90° hold function
- ▶ 90° stop or 360° rotation

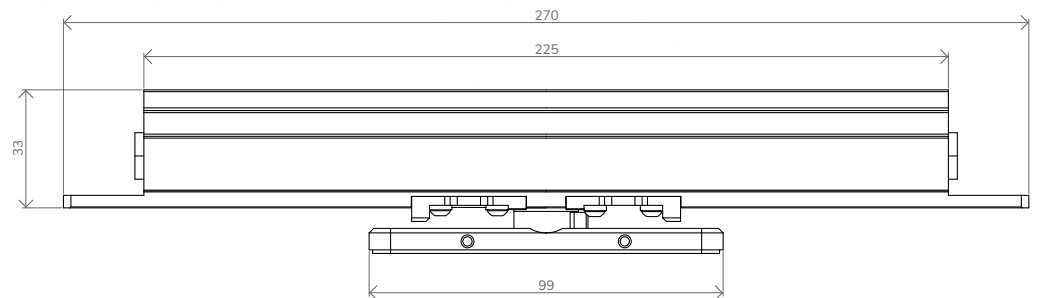
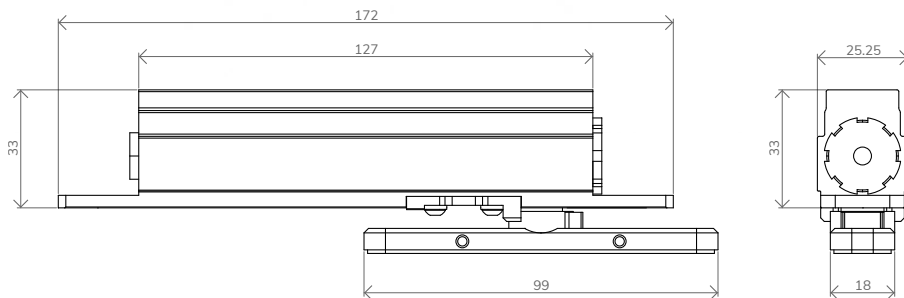

02/ Easy installation

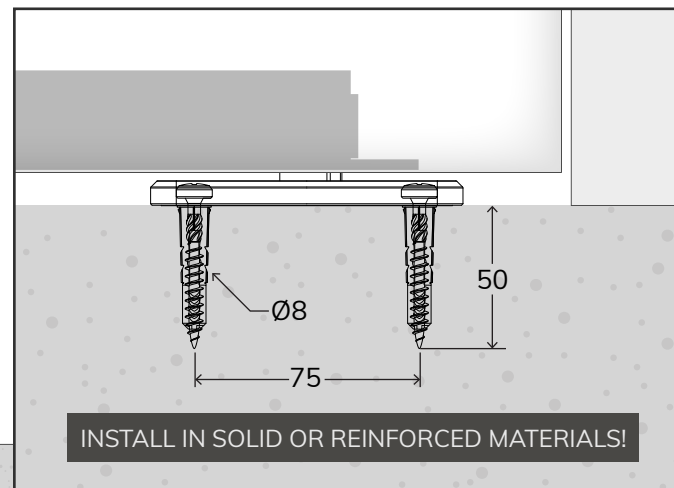
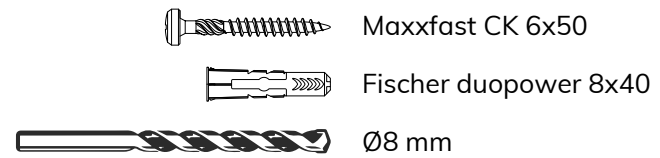
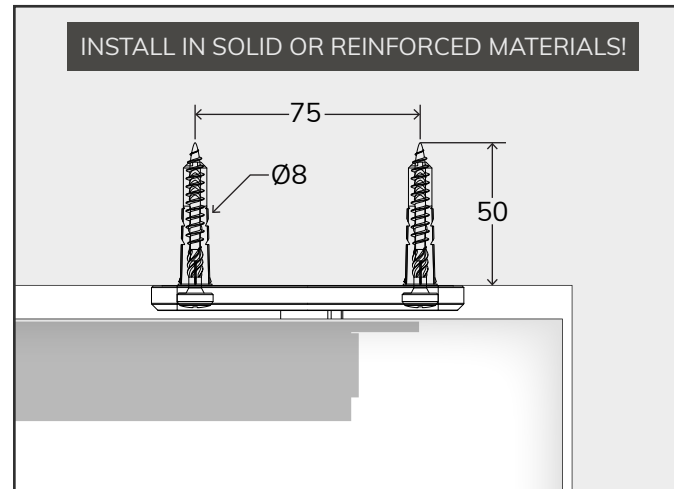

03/ Advised joint dimensions

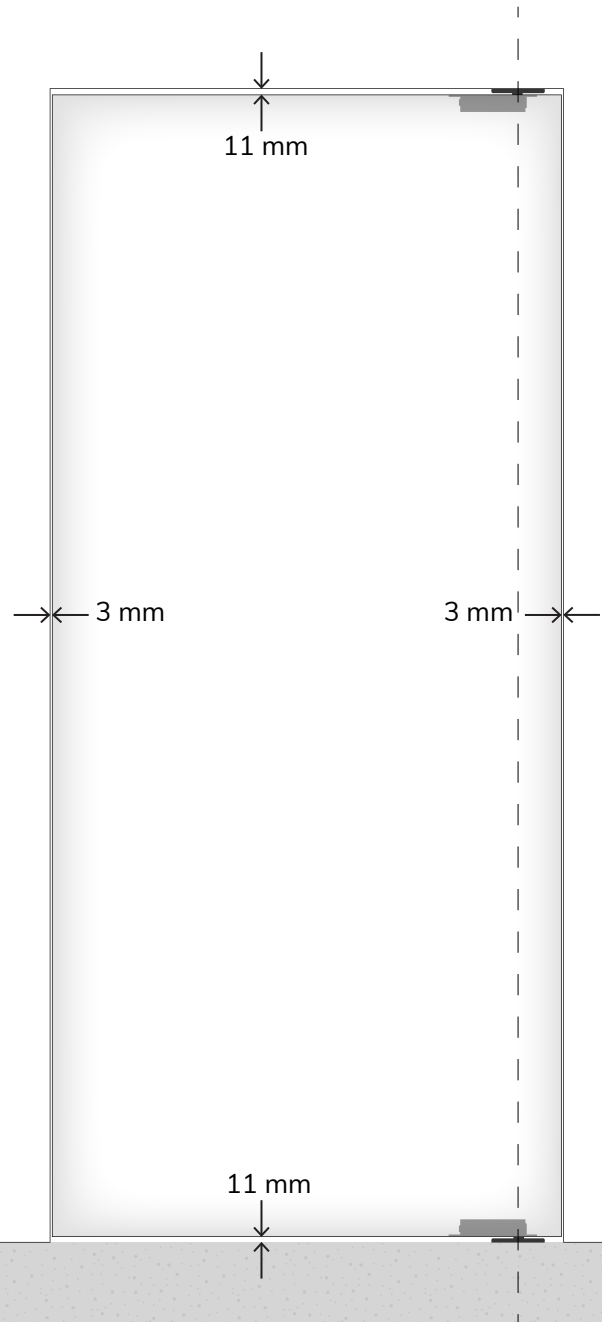

Top & bottom joints = min. 11 mm

Left & right joint

The minimum joint depends on the door thickness and pivot distance. For visual coherence, we advise to use equal joints left and right. See table below for advised left and right joint dimensions.

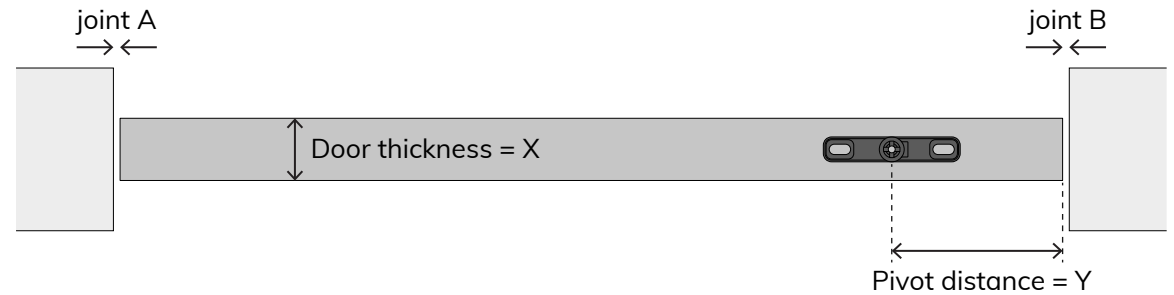

Y ▼	A = B			
1500	2	2	2	2
1000	2	2	3	3
500	2	3	3	3
250	3	3	4	4
85	4	5	7	9
X ►	40	50	60	70

04/ Door specifications

STEALTHPIVOT NL

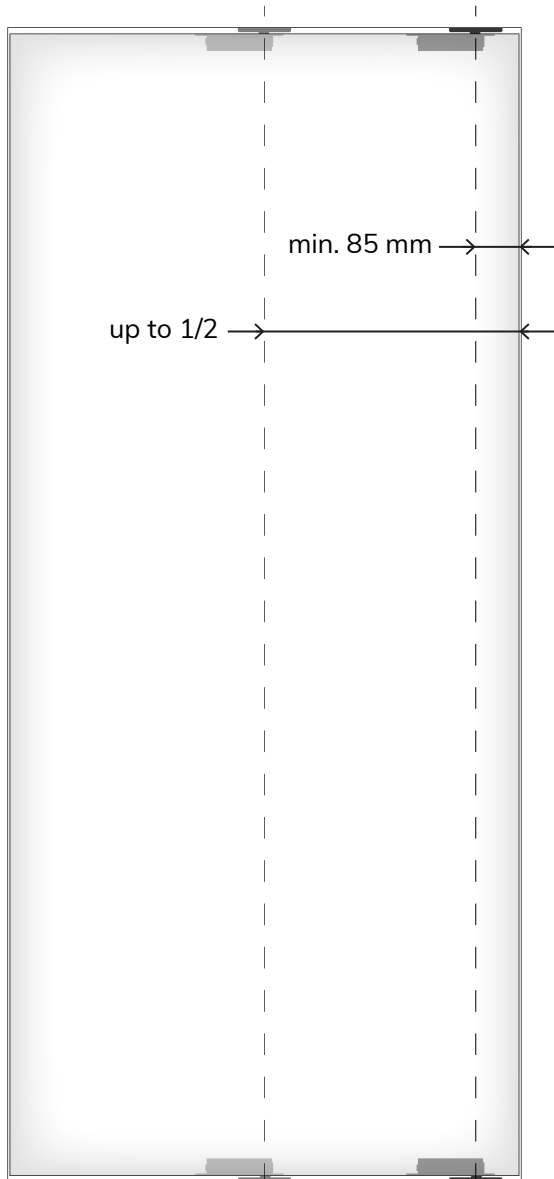

STEALTHPIVOT NL

Max. width = 1250 mm
Max. weight = 75 kg (165 lbs)
Axis: 85 mm up to 1/2

STEALTHPIVOT XL

Max. width = 2250 mm
Max. weight = 150 kg (330 lbs)
Doors < 1250 mm: *axis 150 mm up to 1/2
Doors > 1250 mm: *axis 1/4 up to 1/2

STEALTHPIVOT XL

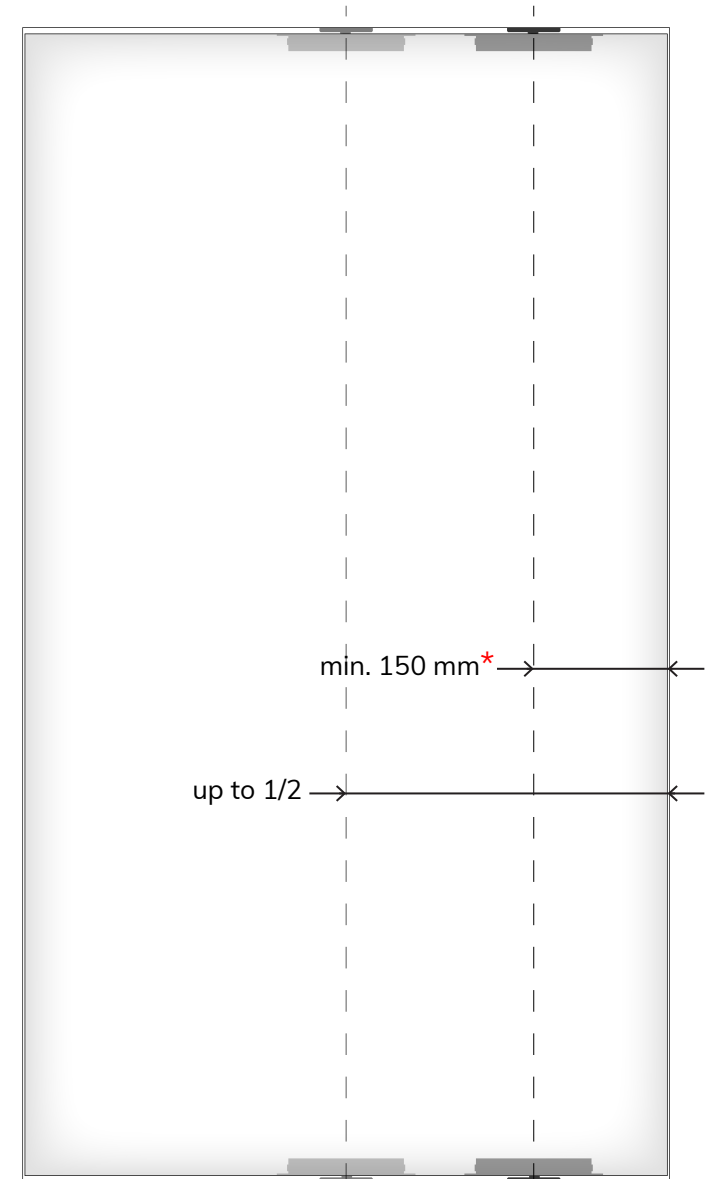

05/ Door rotation and 90° hold

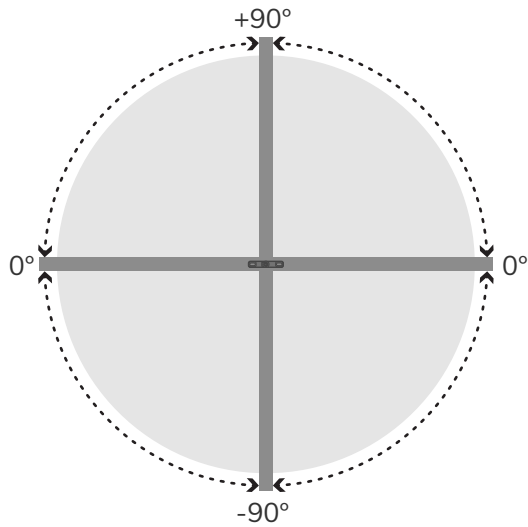

360° rotation with 90° hold

By simply rotating the S90 position, you unlock 360° functionality. The built-in silent hold function activates at $+90^\circ$, 0° and -90° .

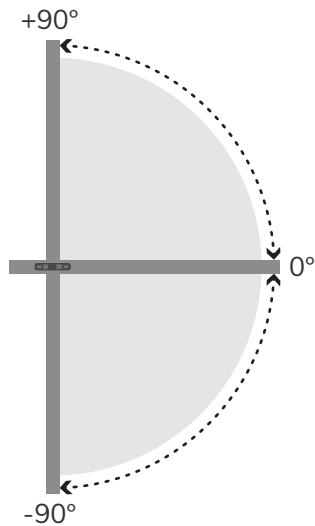
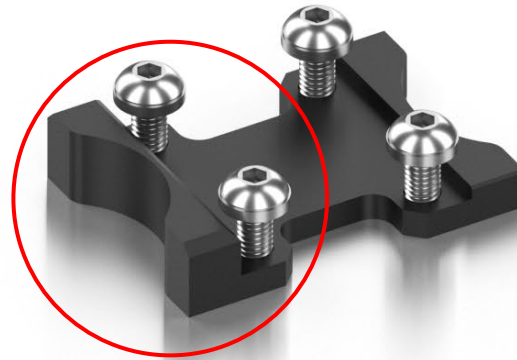

180° rotation with 90° hold

With the S90 installed (thick part against the pivot center), the hinge will stop at $+90^\circ$ and -90° . The built-in silent hold function activates at $+90^\circ$, 0 and -90° .



06/ Self-closing function

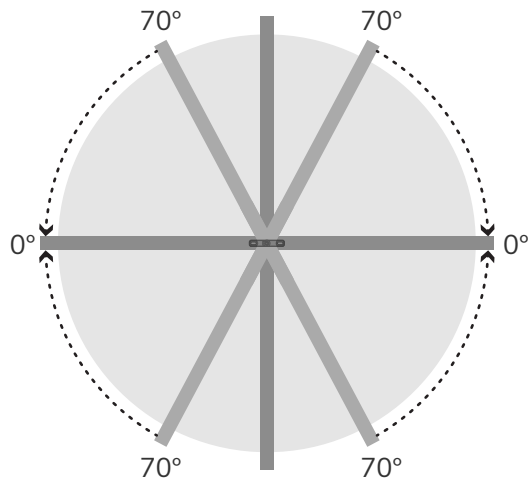



The pivot hinge will start to self-close from a 70° angle. Both pivot hinge systems are equipped with 420N Suspa gas dampers.

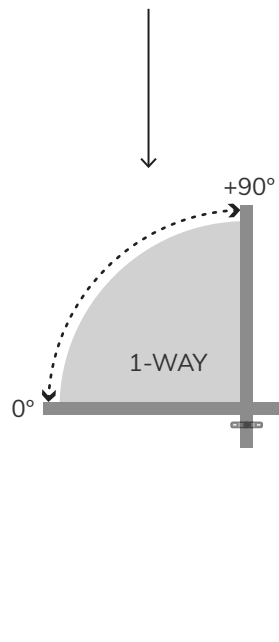
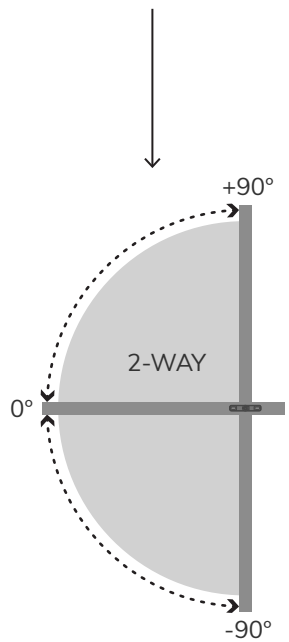
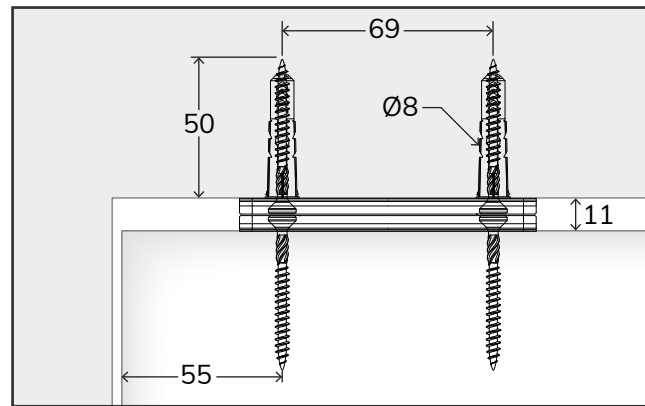
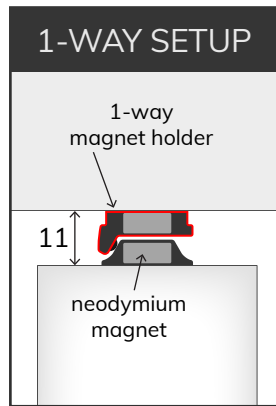
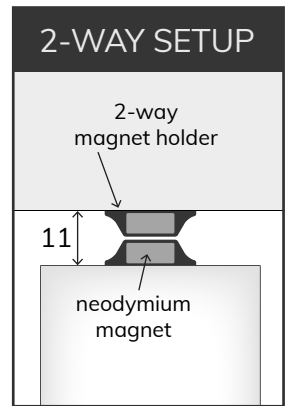

07/ Optional 0° positioning systems

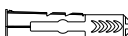

-  Maxxfast CST 4.5x50
-  Fischer duopower 8x40
-  Ø8 mm

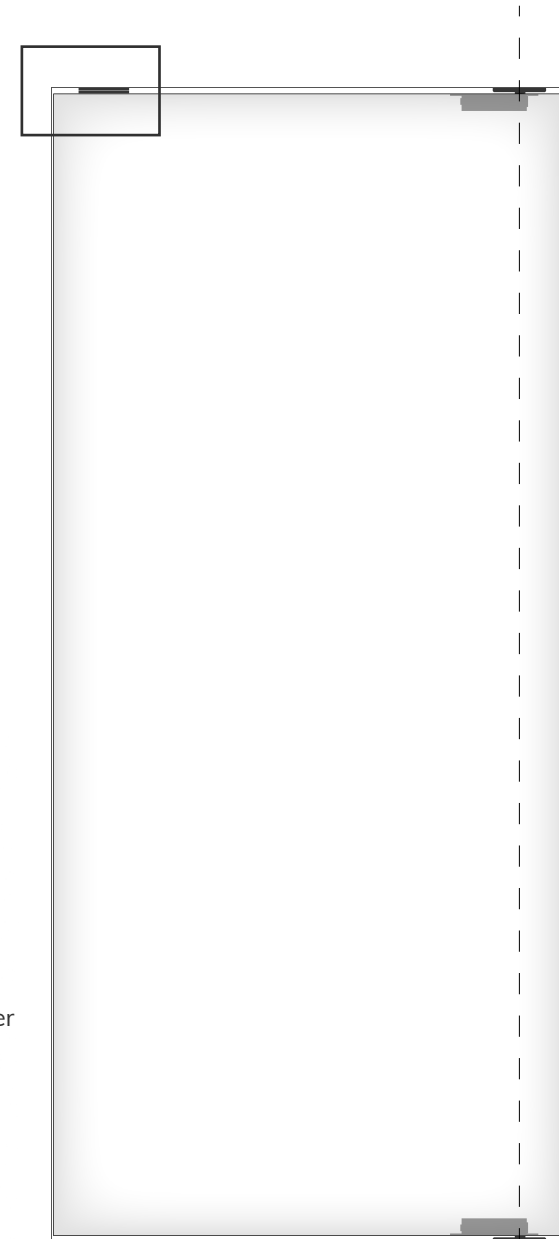

08/ Pivot mount cover

3D printed parts slide and snap over the base of the hinge to cover up the screws and hexagonal inserts.



09/ Stealthpivot cavity dimensions (mm)



STEALTHPIVOT NL



STEALTHPIVOT XL

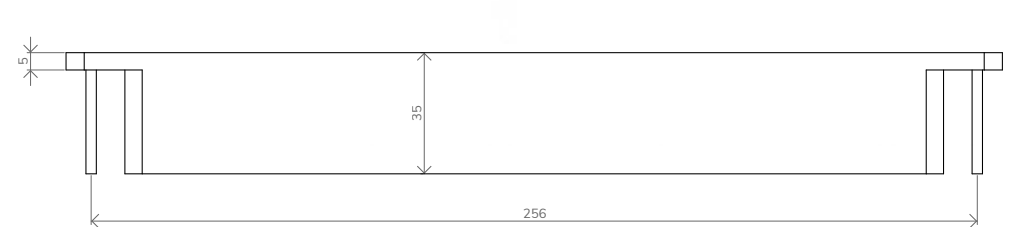
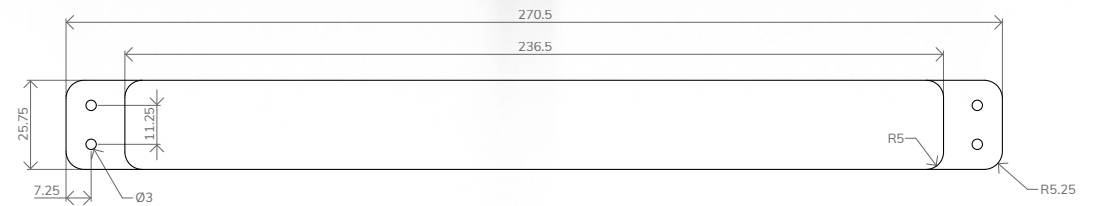
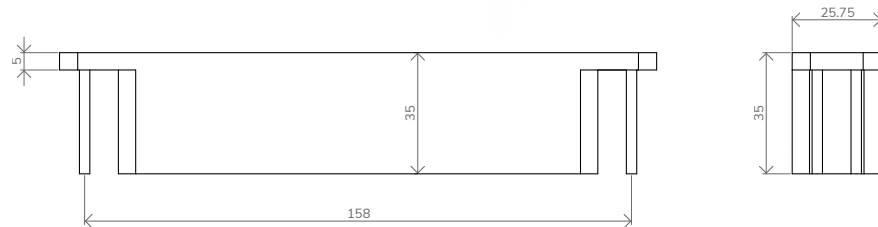
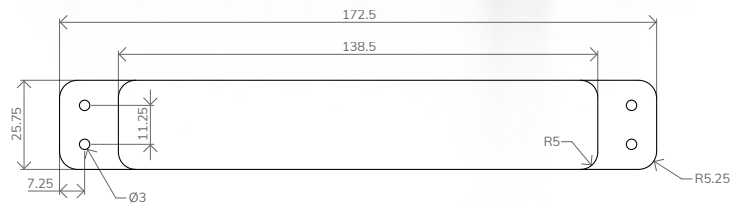

STEALTHPIVOT NL SET

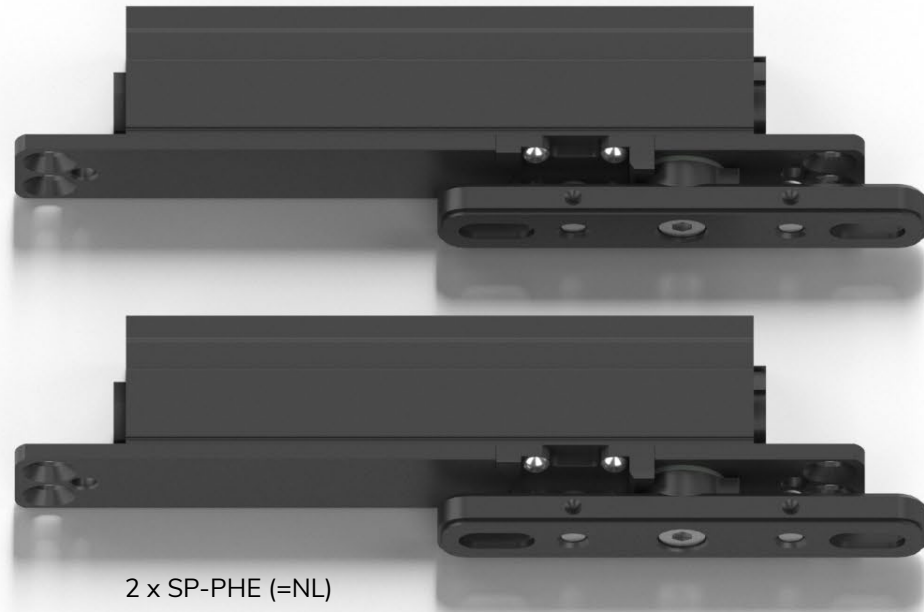

2 x SP-PHE (=NL)



4 x SP-CRL

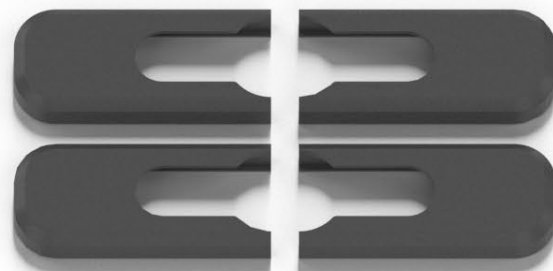

4 x PAP-ADKPB



2 x SP-PZOV 1 mm



2 x SP-PZOV 1.5 mm



2 x SP-PZOV 3 mm



4 x DIN916-M6x6

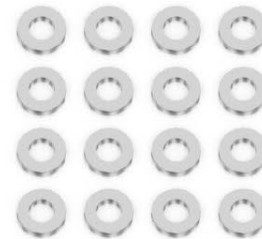

16 x DIN 988-5x10x1 (shims)



1 x TORX BIT TX 25 C6.3



4 x Maxxfast CK 6x50



4 x Fisher Duopower 8x40

STEALTHPIVOT XL SET



2 x SP-PHD (=XL)



4 x DIN916-M6x6

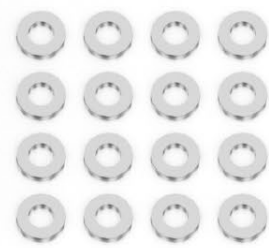

16 x DIN 988-5x10x1 (shims)



1 x TORX BIT TX 25 C6.3



4 x SP-CRL



4 x SP-PZOV 1 mm



4 x SP-PZOV 1.5 mm

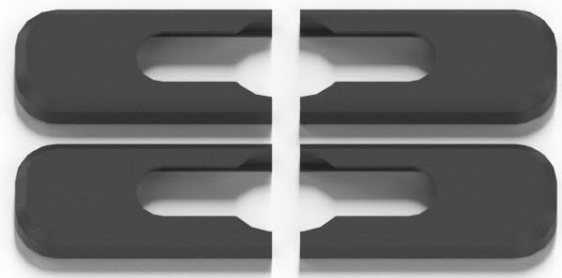

4 x PAP-ADKPB



2 x SP-PZOV 3 mm

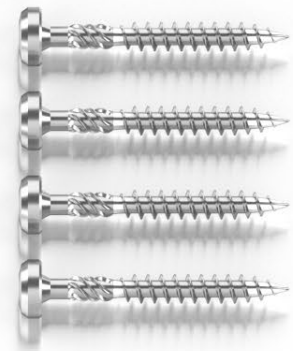

4 x Maxxfast CK 6x50



4 x Fisher Duopower 8x40

OPTIONAL STEALTHPIVOT NL ACCESSORY SET



1 x PAP-1W



2 x PAP-2W



1 x magnet South



1 x magnet North



1 x TORX BIT TX 20 C6.3



2 x screw-ISO 10642 - M4x10

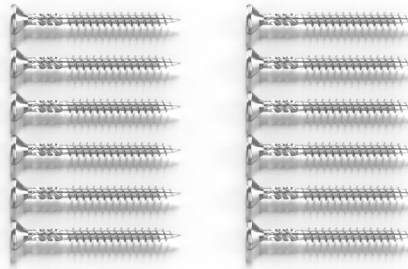

12 x Maxxfast CST 4.5x50



2 x Fisher Duopower 8x40

OPTIONAL STEALTHPIVOT XL ACCESSORY SET



2 x PAP-1W



4 x PAP-2W



2 x magnet South



2 x magnet North



1 x TORX BIT TX 20 C6.3

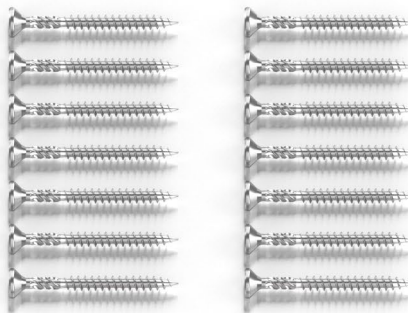

12 x Maxxfast CST 4.5x50

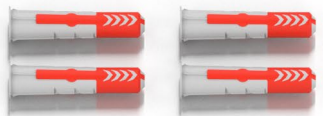

4 x Fisher Duopower 8x40



4 x screw-flathead-cap-ISO 10642 - M4x10

OPTIONAL STEALTHPIVOT INSTALLATION TOOLS



1 x loctite 2400 5 ml

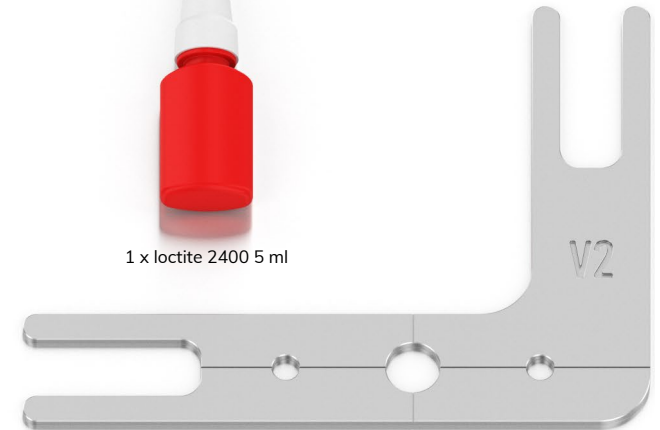

1 x SP-PS&KAL