



WECO srl  
Via S. Antonio, 22 - BELVEDERE  
36050 TEZZE SUL BRENTA (VICENZA) ITALY  
Tel. +39 0424 561943 – Fax +39 0424 561944  
www.weco.it - E-mail info@weco.it

# Multi Power 204T





<b>1</b>	<b>INTRODUCTION .....</b>	<b>4</b>	<b>16</b>	<b>SPARE PARTS.....</b>	<b>24</b>
<b>2</b>	<b>FRONT PANEL .....</b>	<b>4</b>	<b>17</b>	<b>ELECTRICAL DIAGRAM .....</b>	<b>26</b>
<b>3</b>	<b>REAR PANEL .....</b>	<b>5</b>	17.1	MULTI POWER 204T .....	26
<b>4</b>	<b>INSTALLATION .....</b>	<b>5</b>	17.2	TORCH CONNECTOR .....	28
4.1	CONNECTIONS TO THE ELECTRICAL MAINS NETWORK .....	5	17.3	REMOTE CONTROLLER CONNECTOR .....	28
4.2	PREPARING FOR MMA WELDING .....	5			
4.3	PREPARING FOR TIG WELDING .....	6			
<b>5</b>	<b>USER INTERFACE .....</b>	<b>7</b>			
<b>6</b>	<b>UNIT POWER-UP.....</b>	<b>9</b>			
<b>7</b>	<b>RESET (LOAD FACTORY SETTINGS).....</b>	<b>9</b>			
<b>8</b>	<b>SET-UP (INITIAL SET-UP OF THE WELDING POWER SOURCE).....</b>	<b>10</b>			
8.1	TORCH LOADING .....	11			
<b>9</b>	<b>ALARMS MANAGEMENT .....</b>	<b>11</b>			
<b>10</b>	<b>DERATING .....</b>	<b>12</b>			
<b>11</b>	<b>WELDING PARAMETERS.....</b>	<b>13</b>			
	Welding current (MMA) .....	13			
	Maximum RC current in MMA mode .....	13			
	Hot-Start.....	13			
	Arc-Force .....	13			
	Pre-gas time.....	13			
	Starting current .....	13			
	Up slope time .....	13			
	Welding current (TIG) .....	13			
	Maximum pedal current in TIG.....	13			
	Second welding current .....	13			
	Base current.....	13			
	Peak time .....	13			
	Pulsed current frequency .....	13			
	Base time .....	14			
	Down slope time .....	14			
	Final current .....	14			
	Post-gas time .....	14			
	VRD.....	14			
	Long arc voltage MMA .....	14			
	Remote control activation .....	14			
	Spot welding time.....	14			
	HF arc strike enable.....	14			
	Minimum pedal current .....	14			
	Q-Start.....	14			
	Dynamic Arc.....	14			
	Multi Tack.....	14			
11.1	PARAMETERS ACTIVATION .....	15			
<b>12</b>	<b>WELDING SETTINGS.....</b>	<b>16</b>			
12.1	ELECTRODE WELDING (MMA) .....	16			
12.1.1	MMA PARAMETERS SETTING (1ST LEVEL).....	16			
12.1.2	MMA PARAMETERS SETTING (2ND LEVEL) .....	16			
12.1.3	MMA SPECIAL FUNCTIONS .....	17			
12.2	DC TIG WELDING.....	17			
12.2.1	DC TIG PARAMETERS SETTING (1ST LEVEL) .....	17			
12.2.2	DC TIG PARAMETERS SETTING (2ND LEVEL) .....	18			
12.2.3	DC TIG SPECIAL FUNCTIONS MENU .....	18			
<b>13</b>	<b>JOBS MANAGEMENT.....</b>	<b>19</b>			
13.1	SAVING A JOB.....	19			
13.2	LOADING A USER JOB OF FACTORY SET JOB.....	19			
13.3	DELETING A JOB .....	19			
<b>14</b>	<b>TORCH TRIGGER MODES .....</b>	<b>20</b>			
14.1	2T LIFT-ARC WELDING.....	20			
14.2	2T HF WELDING .....	20			
14.3	4T LIFT-ARC WELDING.....	20			
14.4	4T HF WELDING .....	21			
14.5	BI-LEVEL LIFT WELDING.....	21			
14.6	BI-LEVEL HF WELDING .....	21			
14.7	2T SPOT WELDING.....	21			
14.8	2T SPOT HF WELDING .....	22			
14.9	PILOT ARC WELDING.....	22			
<b>15</b>	<b>TECHNICAL DATA.....</b>	<b>23</b>			

# 1 INTRODUCTION

**IMPORTANT!**

This handbook must be consigned to the user prior to installation and commissioning of the unit.

Read the "General prescriptions for use" handbook supplied separately from this handbook before installing and commissioning the unit.

The meaning of the symbols in this manual and the associated precautionary information are given in the "General prescriptions for use".

If the "General prescriptions for use" are not present, it is mandatory to request a replacement copy from the manufacturer or from your dealer.

Retain these documents for future consultation.

KEY	
	This symbol identifies an action that occurs automatically as a result of a previous action.
	This symbol identifies additional information or a reference to a different section of the manual containing the associated information.
	This symbol identifies a reference to a chapter of the manual.
	This symbol accompanies important information concerning the execution of the relevant operations.

Multi Power 204T is an inverter DC TIG/MMA portable welding power source.

The solidity of the components of this unit makes it a reliable working companion for workshop and outdoor applications.

The available DC TIG functions and digital control make this unit ideal for maintenance, building construction, and light metalwork.

In MMA welding the Hot Start and Arc Force functions are adjustable and they allow improved arc striking, a flatter bead and more uniform weld.

The Anti Sticking function makes it possible to detach the electrode rapidly from the workpiece in the event of accidental sticking.

Up to 4,00mm diameter electrode welding is possible in MMA.

The power source is designed to guarantee safety and flexibility through the following features:

**OVERCUT:** in case of over-voltage in the supply line, the supply to the power source is cut off.

The overcut protection protects electronic parts of the machine against damage caused by voltage surges.

**CURRENT AUTO-CALIBRATION:** the power source works at a supply voltage ranging between 115V~±15%/50-60Hz and 230V~±15%/50-60Hz.

The maximum value of the adjustable welding current is automatically limited based on the supply voltage measured when the power source is switched on.

**DERATING:** Derating limits current during welding when supply voltage drops below the limit value of 190Vac.

This limits current input so as not to overload the inverter and keeps the welding arc stable.

**FANS:** Fan speed varies based on power source internal temperature measured by thermal sensors.

- This function brings the following improvements:
- reduction of noise.
  - reduction of dust extracted (cleaner equipment, less maintenance).

The welding modes and procedures available are those indicated in the table.

MODE	PROCEDURE
MMA	
TIG CONTINUOUS	2 STEP LIFT-ARC (2T) 2 STEP + HF (2T HF) 4 STEP LIFT-ARC (4T) 4 STEP + HF (4T HF)
TIG PULSED	4 STEP BI-LEVEL (4T B-LEVEL) 4 STEP BI-LEVEL + HF (4T B-LEVEL HF)
SYNERGIC TIG	2T SPOT 2T SPOT + HF

- Accessories that can be connected to the unit:
- manual remote controller for remote adjustment of the welding current.
  - foot-pedal remote controller for TIG torch arc striking and remote adjustment of welding current.
  - UP/DOWN torch or torch with potentiometer.
  - liquid cooler for TIG torches.

# 2 FRONT PANEL

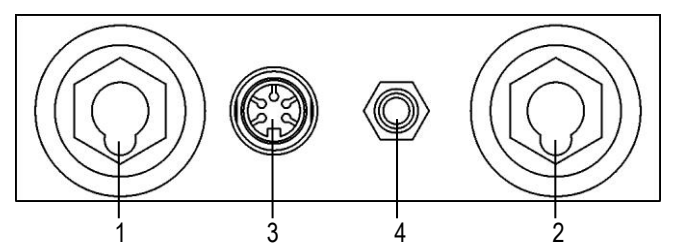

- 1: Negative pole welding socket.
- 2: Positive pole welding socket.
- 3: Connector for logic signals of TIG torch.
- 4: Connector for gas feed hose: power source → torch

### 3 REAR PANEL

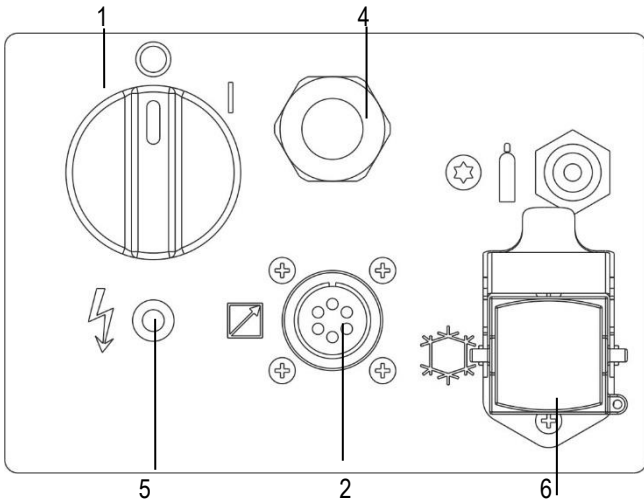

- 1: Welding power source ON/OFF switch.
- 2: Remote controller connector.
- 3: Connector for gas feed hose:  
cylinder → power source
- 4: Power cable.

Total length (including internal part)	2.5 m
Number and cross section of wires	3 x 2.5 mm <sup>2</sup>
Type of plug supplied	Schuko

- 5: Warning LED for overcut protection triggering.
- 6: Pre-arrangement for the supply socket of the cooling unit  
(purchasing and installing the relative kit).

### 4 INSTALLATION

**WARNING!**  
Lifting and positioning

Read the warnings highlighted by the following symbols in the "General prescriptions for use".

#### 4.1 CONNECTIONS TO THE ELECTRICAL MAINS NETWORK

The characteristics of the mains power supply to which the equipment shall be connected are given in the section entitled "technical data" on page 23.

The machine can be connected to motorgenerators provided their voltage is stabilised.

Connect/disconnect the various devices with the machine switched off.

#### 4.2 PREPARING FOR MMA WELDING

1. Set the welding power source ON/OFF switch to "O" (unit de-energized).
2. Plug the power cable plug into a mains socket outlet.

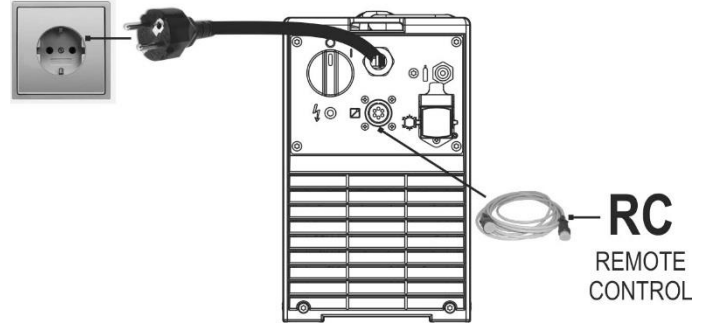

3. Choose the electrode based on the type of material and thickness of the workpiece to be welded.
4. Insert the electrode in the electrode holder.
5. Connect the electrode holder clamp plug to the following welding socket: Positive pole welding socket.
6. Connect the earth clamp plug to the following welding socket: Negative pole welding socket.
7. Connect the earth clamp to the workpiece being processed.

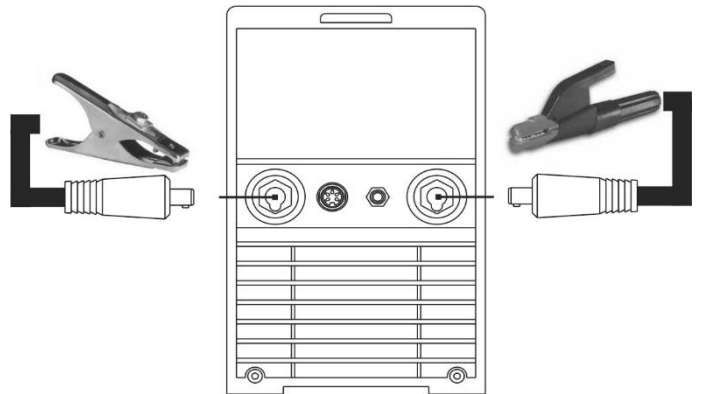

**WARNING!**  
Electric shock hazard!

Read the warnings highlighted by the following symbols in the "General prescriptions for use".

8. Set the welding power source ON/OFF switch to "I" (unit powered).
  9. Select the following welding mode on the user interface: MMA
  10. Set the required welding parameter values on the user interface.
- ⓘ When the remote controller [RC] is connected and the relative locking screw is tightened, welding current can be adjusted using the remote controller.

The system is ready to start welding.

### 4.3 PREPARING FOR TIG WELDING

1. Set the welding power source ON/OFF switch to "O" (unit de-energized).
2. Plug the power cable plug into a mains socket outlet.

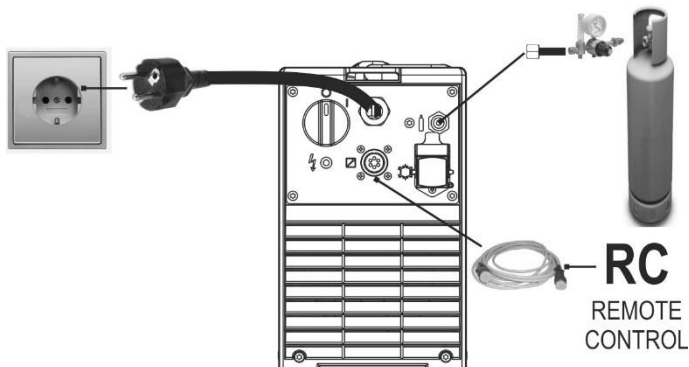

3. Connect the gas hose from the welding gas cylinder to the rear gas socket.
4. Open the cylinder gas valve.

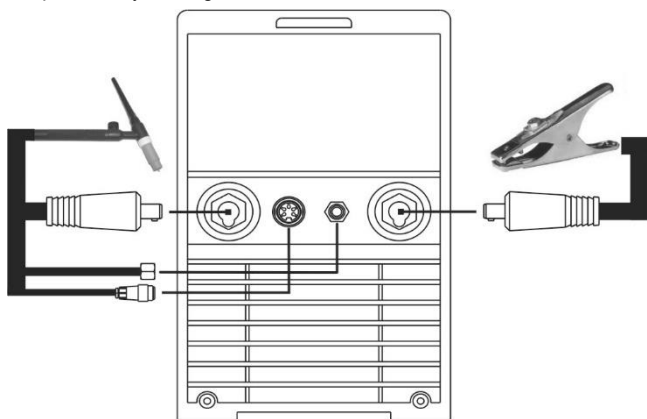

5. Connect the gas hose from the welding torch to the front gas socket.
  6. Connect the electrode holder clamp plug to the following welding socket: Negative pole welding socket.
  7. Choose the electrode based on the type of material and thickness of the workpiece to be welded.
  8. Insert the electrode in the TIG torch.
  9. Connect the earth clamp plug to the following welding socket: Positive pole welding socket.
  10. Connect the earth clamp to the workpiece being processed.
  11. Set the welding power source ON/OFF switch to "I" (unit powered).
  12. Select the following welding mode on the user interface: DC TIG
  13. Press the torch trigger with the torch well clear of any metal parts. This serves to open the gas solenoid valve without striking the welding arc.
  14. Use the flow control valve to adjust the flow of gas as required while the gas is flowing out.
  15. Set the required welding parameter values on the user interface.
- ⓘ When the remote control pedal is connected and the relative locking screw is tightened the welding current will vary in relation to the pressure exerted on the pedal.

The system is ready to start welding.



## 5 USER INTERFACE

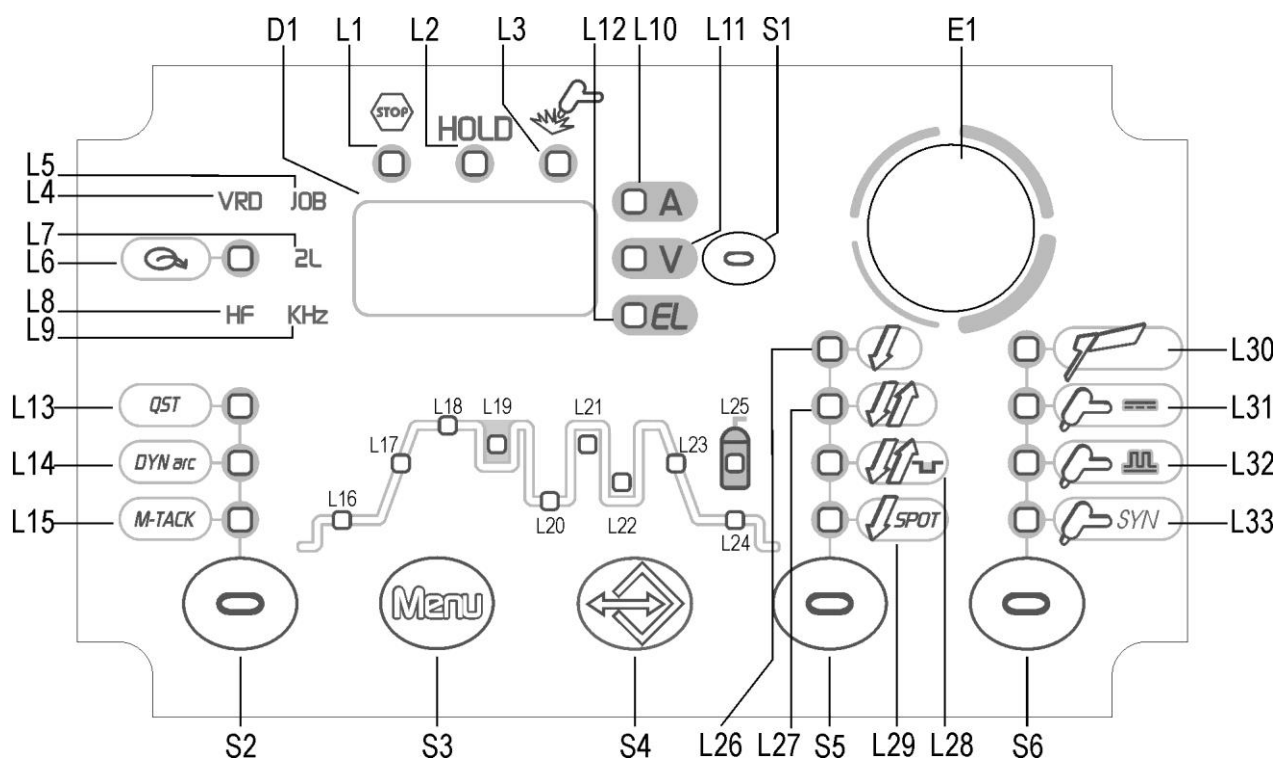

CODE	SYMBOL	DESCRIPTION
L1		This LED illuminates to show an anomaly in the operating conditions. ① See "ALARMS MANAGEMENT" (§ 9 page 11).
L2	<b>HOLD</b>	When this LED illuminates the last voltage and current average values measured during welding are shown on following displays: D1 The "HOLD" function is cleared when a new weld is started or when any setting is changed.
L3		This LED illuminates to confirm the presence of power on the output sockets.
L4	<b>VRD</b>	Illumination shows that the following function has been activated: reduction of the output voltage ( $U_0$ )
L5	<b>JOB</b>	Illuminates to show that a previously saved JOB has been loaded.
L6		This LED indicates that the current reference setting is imposed by the remote controller.
L7	<b>2L</b>	When this LED illuminates the 2nd level Menu parameter is shown.
L8	<b>HF</b>	Illumination shows that the following function has been activated: High frequency arc strike (HF)
L9	<b>KHz</b>	Illuminates to show a value in the following unit of measurement: KILOHERTZ
L10	<b>A</b>	Illuminates to show a value in the following unit of measurement: AMPERES
L11	<b>V</b>	Illuminates to show a value in the following unit of measurement: VOLTS
L12	<b>EL</b>	When this LED illuminates the following parameter can be set: ELECTRODE TYPE
L13	<b>QST</b>	<b>DC TIG mode:</b> Illumination shows that the following function has been activated: Q-START
L14	<b>DYN arc</b>	<b>DC TIG mode:</b> Illumination shows that the following function has been activated: DYNAMIC ARC
L15	<b>M-TACK</b>	<b>DC TIG mode:</b> Illumination shows that the following function has been activated: MULTI TACK
L16		When this LED illuminates the following parameter can be set: STARTING CURRENT
L17		When this LED illuminates the following parameter can be set: SLOPE UP
L18		When this LED illuminates the following parameter can be set: WELDING CURRENT
L19		When this LED illuminates the following parameter can be set: SECOND WELDING CURRENT
L20		When this LED illuminates the following parameter can be set: BASE CURRENT
L21		When this LED illuminates the following parameter can be set: PEAK TIME / DUTY CICLE



L22		When this LED illuminates the following parameter can be set: BASE TIME
L21 + L22		When this LED illuminates the following parameter can be set: PULSED CURRENT FREQUENCY
L23		When this LED illuminates the following parameter can be set: DOWN SLOPE
L24		When this LED illuminates the following parameter can be set: FINAL CURRENT
L25		When this LED illuminates the following parameter can be set: POST-GAS
L26		Illumination shows that the following function has been activated: 2 times procedure ① § 14.1 page 20 / § 14.2 page 20
L27		Illumination shows that the following function has been activated: 4 times procedure ① § 14.3 page 20 / § 14.4 page 21
L28		Illumination shows that the following function has been activated: 4 times Bi-level procedure ① § 14.5 page 21 / § 14.6 page 21
L29		A flashing signal means the following function is activated: 2 times procedure ① § 14.7 page 22 / § 14.8 page 22
L30		This LED illuminates to show that the following welding mode is selected: MMA
L31		This LED illuminates to show that the following welding mode is selected: TIG CONTINUOUS
L32		This LED illuminates to show that the following welding mode is selected: TIG PULSED
L33		<b>DC TIG mode:</b> When this LED illuminates the following parameter can be set: TIG SYNERGIC PULSE When this is on, it means that the synergic mode is active and that the operator can set just the welding current while the other parameters are automatically regulated by the machine. The synergy is optimised by angle welding.
D1		<b>Parameters/functions setting:</b> The display shows the selected parameter. <b>Welding:</b> The display shows the effective amperes or volts value during welding. <b>HOLD function:</b> The display shows the current of voltage average values of the last welding process.
E1		<b>Parameters/functions setting:</b> The encoder provides the facility to alter the selected parameter. <b>Welding:</b> The encoder allows the welding current to be modified.
S1		<b>Parameters/functions setting:</b> This button selects the parameter to be shown on the following display: D1 Possible choices: - (A) Preset welding current - (V) No-load voltage - (EL) Preset type of electrode <b>Welding:</b> This button selects the parameter to be shown on the following display: D1 Possible choices: - (A) Effective welding current - (V) Effective welding voltage
S2		<b>HOLD function:</b> This button selects the parameter to be shown on the following display: D1 Possible choices: - (A) Average welding current - (V) Average welding voltage <b>TIG Mode:</b> Press the button to select the parameter to be set. Possible choices: - Q-START - DYNAMIC ARC - MULTI TACK <b>MMA mode:</b> This button is not used.
S3		Press the button once to select the parameters of the first level menu. Hold down the button for 3 seconds to gain access to the second level menu. Hold down the button at the time of power-on to gain access to the SETUP menu.
S4		Press the button once to open the JOB upload menu. Hold down the button for 3 seconds to gain access to the JOB save/delete menu.
S5		This button selects the torch trigger mode. ① § 14 page 20
S6		This button selects the welding mode.



## 6 UNIT POWER-UP

Set the welding power source ON/OFF switch to "I" to switch on the unit.

- ➡ **Fx.x** The message appears on the following displays: D1  
x.x= software version

### First power-up or power-ups following a RESET procedure

- ➡ The welding power source sets up for welding with the factory presets.

### Subsequent power-ups

- ➡ The welding power source sets up for welding in the latest stable welding configuration that was active at the time of power-off.

The power source works at a supply voltage ranging between 115V~±15%/50-60Hz and 230V~±15%/50-60Hz.

The maximum value of the adjustable welding current is automatically limited based on the supply voltage measured when the power source is switched on.

SUPPLY VOLTAGE	CURRENT RANGE THAT CAN BE SET (MMA)	CURRENT RANGE THAT CAN BE SET (TIG)
115 V~ ±15 % / 50 - 60 Hz	10 A - 115 A	5 A - 115 A
230 V~ ±15 % / 50 - 60 Hz	10 A - 180 A	5 A - 200 A

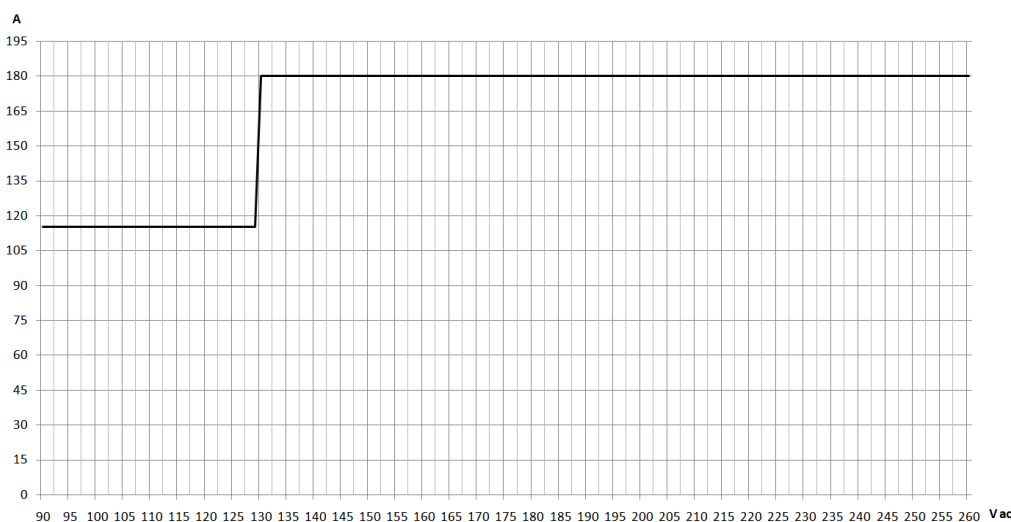

## 7 RESET (LOAD FACTORY SETTINGS)

The reset procedure involves complete restoration of the default values, parameters and memory settings set in the factory.

All memory locations will be reset and hence all your personal welding settings will be lost!

The reset procedure is useful in the following cases:

- Too many changes made to the welding parameters so user finds it difficult to restore defaults.
- Unidentified software problems that prevent the welding power source from functioning correctly.

Set the welding power source ON/OFF switch to "O" to switch the unit off.

- S2 S6 Hold down both buttons simultaneously.

Set the welding power source ON/OFF switch to "I" to switch on the unit.

- S2 S6 Release buttons.

- ➡ **FAC** The message appears on the following displays: D1



SIMULTANEOUS ACTIONS

## 8 SET-UP (INITIAL SET-UP OF THE WELDING POWER SOURCE)

Set the welding power source ON/OFF switch to "O" to switch the unit off.

S3 Hold down the button.

Set the welding power source ON/OFF switch to "I" to switch on the unit.

**Set** The message appears for a few seconds on the following displays: D1

S3 Press the button to confirm.

The value relative to the selected setting appears on the following displays: D1

E1 Using the encoder, edit the value of the selected setting.

Press any key (except S3) to save the setting and quit the menu.



**Tab. 1 - Setup settings**

	SETTING	MIN	DEFAULT	MAX	
Coo	COOLER ACTIVATION	OFF	AUT	ON	
St.C.	STARTING CURRENT	%	A	A	*1
F.Cu.	FINAL CURRENT	%	A	A	*1
HF.C.	HF CURRENT	20 A	SYN	200 A	
PUL.	TYPE OF PULSED CURRENT	SLO. (*2)	SLO.	FA. (*3)	
P.A.	PILOT ARC	OFF	OFF	ON	
StS	SPECIAL TORCH STROKE	oFF	oFF	2	
rHF	RESTART HF	oFF	on	on	

\*1: The value of this parameter can be set as a percentage of the welding current or as an absolute value expressed in Amperes.

\*2: This setting enables slow pulsed mode.

\*3: This setting enables fast pulsed mode.

### Cooler activation

- ON= The cooler is always running when the power source is switched on. This mode is preferable for heavy duty and automatic welding procedures.
- OFF= The cooler is always disabled because an air-cooled torch is in use.
- AUT= When the unit is switched on the cooler is switched on for 16 s. During welding procedures the cooler runs constantly. When welding is terminated the cooler continues to run for 90 s + a number of seconds equivalent to the average current value shown using the HOLD function.

### HF Current

This parameter establishes the current value during HF discharge. The value of this parameter can be set as an absolute value or in SYN.

With SYN setting the HF current value is calculated automatically on the basis of the preset welding current value.

Consequences of a higher value:

- Arc striking is facilitated, even on very dirty workpieces.
- Risk of piercing excessively thin gauge workpieces.

### Pilot arc

The function enables the output of a low current between the 1st and 2nd times of the torch trigger to shield the mask in advance and avoid the risk of blinding flashback caused by the welding current.

### Special torch stroke

The parameter changes the torch trigger operating mode.

oFF: indicates standard operation.

- 1: specifies the 4T B-level management variant. Allows the transition to the secondary welding current by pressing and holding down the UP or DOWN button; when the button is released, the primary current is restored. With variant oFF selected, the UP/DOWN buttons are disabled for all procedures.
- 2: specifies the down slope management variant. By releasing the torch trigger during the third stroke (3S) the down slope is stopped and the final current is immediately delivered without having to go through the entire slope time.

**Restart HF**

This parameter changes the HF arc striking operation in the HF 4 stroke torch button mode. When set to "oFF", the automatic HF arc striking discharge is disabled when the long arc welding mode is exited; to restart the welding operation, the torch trigger must be pressed again. When set to "on" and the long arc welding mode is exited, the HF discharge is automatically started as soon as the torch electrode approaches the workpiece. Disabling the automatic striking is useful to prevent the accidental arc striking when the torch touches a part connected to the equipment earth (such as the welding table) after exiting the long arc welding mode.

**8.1 TORCH LOADING**

WARNING!

Make sure the torch in use is correctly sized in relation to the welding current required and for the available and selected cooling type. This prevents the risk of burns to which the operator is potentially exposed, potential faults, and irreversible damage to the torch and the system. If a torch is installed or replaced while the unit is running, the circuit of the newly installed must be filled with coolant to avoid the risk of damage to the torch in the case of high voltage arc strikes without any liquid in the circuit.

**Power-up with operation of the cooler set to "ON" or "AUT" mode**

A check is performed automatically of the presence of liquid in the cooling circuit and the cooler is switched on for 15 seconds.

If the coolant circuit is full, the power source sets up in the most recent stable welding configuration.

If the coolant circuit is not full, all functions are inhibited and there will be no output power present.

- ➡ **A.I.C.** The message appears on the following displays: D1
- (any) ⓪ Press the button or torch trigger to repeat the checking procedure for an additional 15 seconds.
- If the problem persists rectify the cause of the alarm.

**Power-up with operation of the cooler set to "OFF"**

- ➡ Operation of the cooler and the cooler alarm are disabled.
- ➡ Welding is performed without liquid cooling of the torch.

**Torch change-over with operation of the cooler set to "ON"**

Press and release the torch trigger.

- ➡ This serves to start the cooler for 15 seconds to fill the torch cooling circuit.

**9 ALARMS MANAGEMENT**

⏹ This LED illuminates if an incorrect operating condition occurs.

➡ An alarm message appears on the following display: D1

S1 ⓪ Press the button to display the additional alarm message.

**Tab. 2 Alarm messages**

MESSAGE	ADDITIONAL MESSAGE	MEANING	EVENT	CHECKS
Al. H.	t1 xxx t2 xxx xxx= temperature measured by the probe	<b>Overheating alarm</b> Indicates tripping of the welding power source thermal protection. Leave the unit running so that the overheated components cool as rapidly as possible. When the unit has cooled, the welding power source will reset automatically.	All functions disabled. Exceptions: - cooling fan.	- Make sure that the power required by the welding process is lower than the maximum rated power output. - Check that the operating conditions are in compliance with the welding power source data plate specifications. - Check for the presence of adequate air circulation around the welding power source.
E.02	ntC oFF	<b>Alarm, thermal probes faulty</b>	All functions disabled. Exceptions: - cooling fan.	Qualified technical personnel are required for maintenance jobs
Al.P.	-	<b>Power board alarm</b> It means that the power board is malfunctioning	All functions disabled. Exceptions: - cooling fan.	Check that the operating conditions are in compliance with the welding power source data plate specifications. If the problem persists: qualified technical personnel are required for maintenance jobs



MESSAGE	ADDITIONAL MESSAGE	MEANING	EVENT	CHECKS
Al.C.	-	<p><b>Cooler alarm</b> Indicates insufficient pressure in the torch liquid cooling circuit.</p>	<p>All functions disabled. Exceptions: - cooling fan. The alarm message persists on the display until the first operation is performed on the user interface. <b>Cooler "ON"</b>: the alarm is signalled as long as the unit alarm is active and the cooler presence signal persists. <b>Cooler "OFF"</b>: the alarm is never signalled, irrespective of the circumstances. <b>Cooler "AUT"</b>: the alarm is signalled at the times in which the unit is running; the alarm signal occurs as long as the unit presence signal persists.</p>	<ul style="list-style-type: none"> <li>- Check that the connection to the cooler is correct.</li> <li>- Check that the O/I switch is set to I and that it illuminates when the pump is running.</li> <li>- Check that the cooler is filled with coolant.</li> <li>- Check that the cooling circuit is liquid tight, notably the torch hoses and the internal connections of the cooler.</li> </ul>

## 10 DERATING

Derating is a machine function that cannot be selected by the user.

Derating limits the maximum welding current if the supply voltage drops below 190Vac.

For example, if the power source is set to weld with a current of 175A, that current will be the power source output until the supply voltage will range between 184Vac and 230Vac.

If voltage drops to 165Vac, the power source automatic output current will be 160A.

The following diagram displays the maximum output current, based on the voltage supplied to the power source.

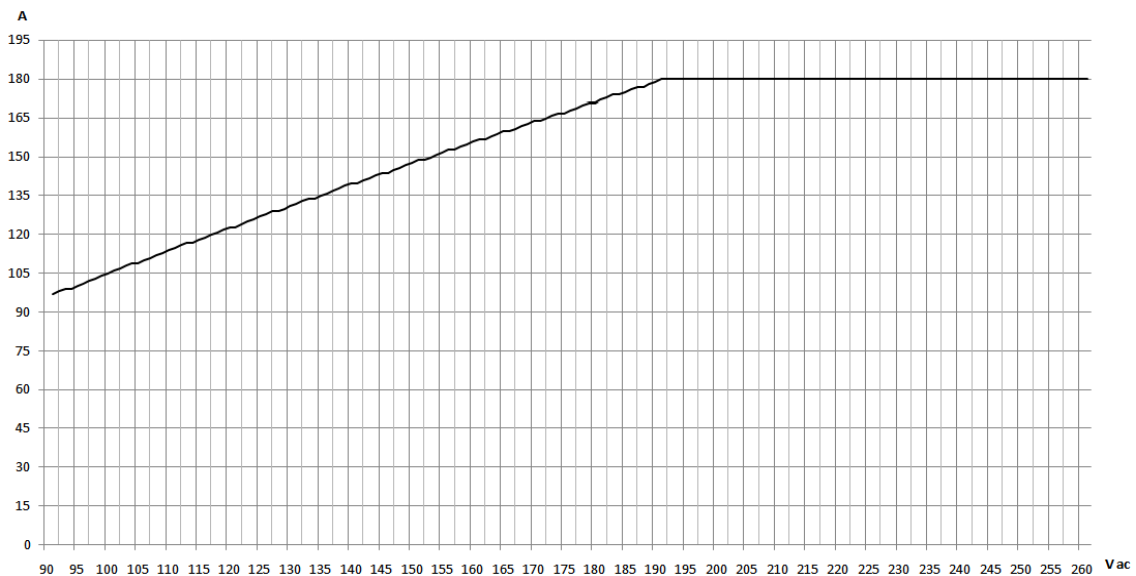

## 11 WELDING PARAMETERS

For a better understanding of the parameter functions described in the table, refer to the following diagram.

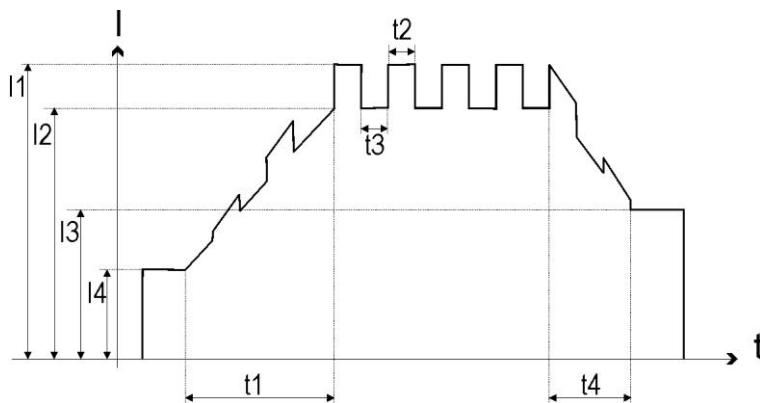

(I1) MAX WELDING CURRENT

(I2) BASE CURRENT

(I3) FINAL CURRENT

(I4) START CURRENT

(t1) UP SLOPE TIME

(t2) PEAK TIME

(t3) BASE TIME

(t4) DOWN SLOPE TIME

 $(1/t2+t3)$  PULSE FREQUENCY

### Welding current (MMA)

Output current value during MMA welding.

### Maximum RC current in MMA mode

Maximum output current value that can be achieved with remote controller external reference.

### Hot-Start

This parameter aids electrode melting at the time of arc striking.

Consequences of a higher value:

- Easier arc strike.
- Increased spatter at welding start.
- Increase of strike area.

Consequences of a lower value:

- More difficult arc strike.
- Less spatter at welding start.
- Smaller strike area.

### Arc-Force

This parameter helps to avoid electrode sticking during welding.

Consequences of a higher value:

- Fluidity during welding.
- Welding arc stability.
- Greater electrode fusion in workpiece.
- More welding spatter.

Consequences of a lower value:

- The arc is extinguished more easily.
- Less welding spatter.

### Pre-gas time

Time of gas delivery before the arc strike.

Consequences of a higher value:

- This parameter allows a shielded environment to be created, thereby eliminating contaminants at the start of the welding pass.

### Starting current

Unit current output value immediately after the arc strike.

### Up slope time

Time during which the current changes from the starting value to the welding value by means of a slope.

### Welding current (TIG)

Current output value during TIG welding.

### Maximum pedal current in TIG

Maximum output current value that can be achieved with foot pedal controller external reference.

### Second welding current

With a rapid press and release (less than 0.5 seconds) of the torch trigger during welding, the output current value switches to the value set by means of the "bi-level second current" parameter.

In DC TIG welding, the parameter is useful when welding different gauge workpieces during the same pass; when moving between different gauges the output current can be changed simply by pressing the torch trigger.

### Base current

Pulsed wave minimum current.

Consequences of a higher value:

- Faster creation of weld pool.
- Increase of heat-affected zone.

### Peak time

Time for which the current pulse is at the maximum value.

Consequences of a higher value:

- Greater weld penetration.
- Facility to make deeper cuts.

Consequences of a lower value:

- Reduction of heat-affected zone.
- Difficult to create a weld pool.

### Pulsed current frequency

Consequences of a higher value:

- Slower melt speed.
- Reduction of heat-affected zone.



### Base time

Time during which current output is at the base value.

Consequences of a higher value:

- The filler material is spread more evenly.
- Increase of heat-affected zone.

### Down slope time

Time during which the current changes from the welding value to the end value by means of a slope.

### Final current

During electrode welding the parameter makes it possible to obtain a uniform deposit of filler material from the start to the end of the welding process, closing the deposition crater with a current such as to deposit a final droplet of filler material.

By keeping the torch trigger pressed during the 3rd time, the crater filler current is maintained thereby ensuring optimal crater filling, until the POST GAS time is started by releasing the torch trigger (4th time).

### Post-gas time

Time of post gas delivery when the welding arc is extinguished.

Consequences of a higher value:

- More effective pickling (improved appearance of workpiece at the end of the welding pass).
- Higher gas consumption.

Consequences of a lower value:

- Lower gas consumption.
- Oxidation of electrode tip (more difficult arc strike).

### VRD

This parameter reduces the potential across the welding sockets when welding is not in progress.

The arc strike procedure is as follows:

- Touch the workpiece with the electrode tip.
- Raise the electrode.

Power is released for several seconds.

- Touch the workpiece with the electrode tip.

The welding arc will strike.

### Long arc voltage MMA

This parameter inhibits power output when the potential between electrode and workpiece exceeds the preset threshold level.

Consequences of a higher value:

- The welding arc persists even with a significant distance between the electrode and the workpiece.

Consequences of a lower value:

- Faster exit from weld.

### Remote control activation

This parameter enables the unit to receive the current reference signal from a remote control.

### Spot welding time

When the torch trigger is pressed the welding arc persists for the time set in the parameter.

Press the torch trigger again to resume the welding process.

The arc strike procedure is as follows:

Positioning of the torch with the electrode on the workpiece.

Press the torch trigger and keep it pressed.

Lift the torch slightly.

As soon as the electrode is lifted then the HF ignition starts.

The arc ignites for few hundredths of a second (time can be set up).

The result of this is a very precise, not oxidized welding spot without any plastic deformation of the sheet.

### HF arc strike enable

This parameter enables the arc strike in the TIG welding procedure by means of a high frequency (HF) current discharge.

The parameter prevents the inclusion of impurities at the start of the weld pass.

This parameter can harm electronic boards when welding is performed on equipment that incorporates such devices.

### Minimum pedal current

Minimum output current value with foot pedal controller external reference.

The current is set as a percentage with respect to the "maximum foot pedal current" parameter.

### Q-Start

This parameter allows the unit to start in synergic pulsed TIG mode for the preset time interval, before switching automatically to the welding procedure selected on the interface panel.

The parameter creates a weld pool faster with respect to the standard starting procedure.

This parameter is useful when spot welding thin gauge sheet.

### Dynamic Arc

Welding power remains constant even when the distance between electrode and workpiece changes.

Consequences of a higher value:

- The welding arc concentration remains unchanged.
- Prevents electrode sticking.
- Thin workpieces may become deformed more easily.

### Multi Tack

This parameter allows thin gauge sheet to be welded without deformation.

Consequences of a higher value:

- Welding of thinner gauge sheet without deformation.
- Less melting of material, slower welding process.



## 11.1 PARAMETERS ACTIVATION

The welding parameters are available in accordance with the selected welding mode and procedure.

Certain parameters are available only after other parameters or functions of the unit have been enabled or set.

The table shows the settings required to enable each parameter.

✓: always available

















1: Available with the user interface reference active

2: Available with rC= on and remote controller connected

3: Available with HF= on

4: Not available with M.ta. active

5: Available with PUL.= Slo.

MENU	MODE →													
														
↓	PROCEDURE →													
	PARAMETER ↓													
1°	WELDING CURRENT (MMA)	1												
1°	MAXIMUM RC CURRENT IN MMA MODE	2												
1°	HOT START	✓												
1°	ARC FORCE	✓												
1°	PRE GAS TIME		3	3	3	3	3	3	3	3	3	3	3	3
1°	STARTING CURRENT		4	4	4	4	4	4	4	4	4	4	4	4
1°	UP SLOPE TIME		4	4	4	4	4	4	4	4	4	4	4	4
1°	WELDING CURRENT (TIG)		1	1	1	1	1	1	1	1	1	1	1	1
1°	MAXIMUM PEDAL CURRENT IN TIG		2	2			2	2			2	2		
1°	SECOND WELDING CURRENT					✓				✓				✓
1°	BASE CURRENT						✓	✓	✓	✓	✓	✓	✓	✓
1°	PEAK TIME						✓	✓	✓	✓	✓	✓	✓	✓
1°	BASE TIME						5	5	5	5	5	5	5	5
1°	PULSED CURRENT FREQUENCY						✓	✓	✓	✓	✓	✓	✓	✓
1°	DOWN SLOPE TIME		4	4	4	4	4	4	4	4	4	4	4	4
1°	FINAL CURRENT		4	4	4	4	4	4	4	4	4	4	4	4
1°	POST GAS TIME		✓	✓	✓	✓	✓	✓	✓	✓	✓	✓	✓	✓
2°	ELECTRODE TYPE	✓												
2°	VRD	✓												
2°	LONG ARC VOLTAGE MMA	✓												
2°	REMOTE CONTROL ACTIVATION	✓	✓	✓	✓	✓	✓	✓	✓	✓	✓	✓	✓	✓
2°	SPOT WELDING TIME			✓				✓				✓		
2°	HF ARC STRIKE ENABLE		✓	✓	✓	✓	✓	✓	✓	✓	✓	✓	✓	✓
2°	MINIMUM PEDAL CURRENT		2	2			2	2			2	2		
SPECIAL	Q-START		3		3	3	3		3	3				
SPECIAL	DYNAMIC ARC	✓	✓		✓		✓		✓					
SPECIAL	MULTI TACK		3	3	3		3	3	3		3	3	3	

## 12 WELDING SETTINGS

### 12.1 ELECTRODE WELDING (MMA)

S6 This button serves to select the following welding mode: MMA

#### 12.1.1 MMA PARAMETERS SETTING (1ST LEVEL)

- S3 Press the button.
- E1 Use the encoder to scroll the list of settings to edit.  
 The acronym relative to the selected setting appears on the following displays: D1
- S3 Press the button to confirm.  
 The value relative to the selected setting appears on the following displays: D1
- E1 Using the encoder, edit the value of the selected setting.  
 Press any key (except S3) to save the setting and quit the menu.

**Tab. 3 - Parameters of the 1st level menu in MMA mode**

	PARAMETER	MIN	DEFAULT	MAX	
L11	WELDING CURRENT	10 A	80 A	180 A	
	MAX WELDING CURRENT	10 A	80 A	180 A	
HO.S.	HOT-START	0 %	SYn	100 %	*1 *2
AR.F.	ARC FORCE	0 %	SYn	250 %	*1 *2

\*1: This parameter is set as a percentage referred to the value of the following parameter: WELDING CURRENT

\*2: SYN: This code indicates that parameters control is synergic. The optimal value of this parameter is set automatically by the microprocessor on the basis of the preset welding current value. This value can be displayed but it is not user-adjustable.

When SYN is installed, to display the synergic value press the following button: S1

#### 12.1.2 MMA PARAMETERS SETTING (2ND LEVEL)

- S3 Hold down the button for 3 seconds to gain access to the 2nd level menu.  
 The LED illuminates.
- E1 Use the encoder to scroll the list of settings to edit.  
 The acronym relative to the selected setting appears on the following displays: D1
- S3 Press the button to confirm.  
 The value relative to the selected setting appears on the following displays: D1
- E1 Using the encoder, edit the value of the selected setting.  
 Press any key (except S3) to save the setting and quit the menu.

**Tab. 4 - Parameters of the 2nd level menu in MMA mode**

	PARAMETER	MIN	DEFAULT	MAX		
EL.	ELECTRODE TYPE	-	bAS	-	{ bAS= basic rUt= rutile Crn= chromium/nickel ALU= aluminium	
Urd	VRD	oFF	oFF	On		*4
U.EL.	LONG ARC VOLTAGE MMA	37	SYn	65		*2
rC	REMOTE CONTROLLER ACTIVATION	oFF	oFF	On		*3

\*3: The activation is suitable for the following welding modes:

- MMA
- DC TIG

Compatible remote control types:

- manual remote controller.

\*4: The activation is suitable for the following welding modes:

- MMA

**12.1.3 MMA SPECIAL FUNCTIONS**

- S2 Press this button to scroll the list of settings to edit.
  - The value relative to the selected setting appears on the following displays: D1
- E1 Using the encoder, edit the value of the selected setting.
  - Press any key (except S2) to save the setting and quit the menu.

**Tab. 5 - Special functions in MMA mode**

	PARAMETER	MIN	DEFAULT	MAX
d.Ar.	DYNAMIC ARC	oFF	oFF	On

**12.2 DC TIG WELDING**

- S6 Use this button to select one of the following welding modes:
 

TIG CONTINUOUS	TIG PULSED	SYNERGIC TIG
- S5 Use this button to select one of the following torch trigger procedures:
 

2 STEP	4 STEP	4 STEP BI-LEVEL	2T SPOT

**12.2.1 DC TIG PARAMETERS SETTING (1ST LEVEL)**

- S3 Press this button to scroll the list of settings to edit.

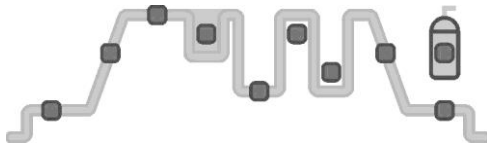

In this diagram the LED relative to the setting to be edited illuminates.

- The value relative to the selected setting appears on the following displays: D1
- E1 Using the encoder, edit the value of the selected setting.
  - Press any key (except S3) to save the setting and quit the menu.

**Tab. 6 - 1st level menu parameters in continuous TIG mode**

	PARAMETER	MIN	DEFAULT	MAX	
P.	PRE-GAS TIME	0.0 s	0.1 s	9.9 s	
L16	STARTING CURRENT	2 %	50 %	200 A	*2
		5 A	40 A	200 A	*2
L17	UP SLOPE TIME	0.0 s	0.0 s	25.0 s	
L18	WELDING CURRENT	5 A	80 A	200 A	
	MAX WELDING CURRENT	5 A	80 A	200 A	
L19	SECOND WELDING CURRENT	10 %	50 %	200 %	*1
L20	BASE CURRENT	1 %	40 %	200 %	*1 *5
		SYn	SYn	SYn	*6
		0.1 s	0.1 s	5 s	*5
L21	PEAK TIME	1 %	50 %	99 %	*4
		SYn	SYn	SYn	*6
L22	BASE TIME	0.1 s	0.1 s	5 s	*5
L21 + L22	PULSED CURRENT FREQUENCY	0.1 Hz	100 Hz	2.5 kHz	*4
		SYn	SYn	SYn	*6
L23	DOWN SLOPE TIME	0.0 s	0.0 s	25.0 s	
L24	FINAL CURRENT	5 %	5 %	80 %	*2
		5 A	5 A	200 A	*2
L25	POST-GAS TIME	0.0 s	SYn	25.0 s	*3

\*1: This parameter is set as a percentage referred to the value of the following parameter: WELDING CURRENT

\*2: The value of this parameter can be set as a percentage of the welding current or as an absolute value expressed in Amperes.

\*3: SYN: This code indicates that parameters control is synergic. The optimal value of this parameter is set automatically by the microprocessor on the basis of the preset welding current value. This value can be displayed but it is not user-adjustable.

\*4: Available when "PUL" parameter =FA.

\*5: Available when "PUL" parameter =SLo.

\*6: Available in the following mode: SYNERGIC TIG

### 12.2.2 DC TIG PARAMETERS SETTING (2ND LEVEL)

- S3 Hold down the button for 3 seconds to gain access to the 2nd level menu.  
**2L** The LED illuminates.
- E1 Use the encoder to scroll the list of settings to edit.  
 The acronym relative to the selected setting appears on the following displays: D1
- S3 Press the button to confirm.  
 The value relative to the selected setting appears on the following displays: D1
- E1 Using the encoder, edit the value of the selected setting.  
 Press any key (except S3) to save the setting and quit the menu.

**Tab. 7 - 2nd level menu parameters in DC TIG mode**

	PARAMETER	MIN	DEFAULT	MAX	
SP.t.	SPOT WELDING TIME	0.01 s	0.1 s	10.0 s	
HF	HF ARC STRIKE ENABLE	On	On	oFF	
r.P.C.	MINIMUM PEDAL CURRENT	1 %	5 %	90 %	*2
rC	REMOTE CONTROLLER ACTIVATION	oFF	oFF	On	*1

\*1: The activation is suitable for the following welding modes:

- MMA
- DC TIG

Compatible remote control types:

- manual remote controller.
- UP/DOWN or potentiometer TIG torch.
- foot pedal controller.

The maximum and minimum TIG welding current values can be set with the foot pedal controller.

The up slope and down slope cannot be controlled via the foot pedal.

The following welding procedures can be selected with the foot pedal:



If both remote controllers are connected, the foot pedal assumes priority over the UP/DOWN or potentiometer TIG torch.

When this function is active welding is performed without the following parameters:

- SLOPE UP
- DOWN SLOPE
- All special functions

\*2: This parameter is set as a percentage referred to the value of the following parameter: WELDING CURRENT

### 12.2.3 DC TIG SPECIAL FUNCTIONS MENU

- S2 Press this button to scroll the list of settings to edit.  
 The value relative to the selected setting appears on the following displays: D1
- E1 Using the encoder, edit the value of the selected setting.  
 Press any key (except S2) to save the setting and quit the menu.

**Tab. 8 - Special functions in MMA mode**

	PARAMETER	MIN	DEFAULT	MAX	
L13	Q-START	0.1 s	oFF	60 s	*3
L14	DYNAMIC ARC	oFF	oFF	On	*3
L15	MULTI-TACK	0.5 Hz	oFF	6.0 Hz	*2 *3

\*2: When this function is active welding is performed without the following parameters:

- SLOPE UP
- DOWN SLOPE
- STARTING CURRENT
- FINAL CURRENT
- DYNAMIC ARC
- Q-START

\*3: When rC= oN and a foot pedal control is connected, all functions are inhibited.

## 13 JOBS MANAGEMENT







Personalised welding settings, or JOBS, can be saved in memory locations and subsequently uploaded.

Up to 45 jobs can be saved (j01-j45).

The settings of the SETUP menu are not saved.

### 13.1 SAVING A JOB

This function is available when welding mode is not active.

- S4  Hold down the button for 3 seconds.  
 **SA.** The message appears on the following displays: D1
- S4  Press the button to confirm.  
 **S.xx** The message appears on the following displays: D1  
 xx= number of the first free job.
- E1  Use the encoder to select the required job number.  
 **S.yy** The message appears on the following displays: D1  
 xx= number of the memory location in which to save the job.  
 On selecting a currently occupied memory location, the job number flashes.  
 If you confirm at this point, the new job will overwrite the previously saved settings.

#### Exit without confirmation





-  Press any button (except S4).  
 This action will automatically close the menu.

#### Exit with confirmation

- S4  Press the button.  
 This action will automatically close the menu.

### 13.2 LOADING A USER JOB OF FACTORY SET JOB



This function is available when welding mode is not active.

- S4  Press and release the button.  
 **L.xx** Only when the jobs have been uploaded, the message is shown on the following displays: D1  
 xx= number of the latest job used.  
 **nO.J** If there are no jobs in the memory the message is shown on the following displays: D1
- E1  Use the encoder to select the number of the job to be uploaded.

#### Exit without confirmation

-  Press any button (except S4).  
 This action will automatically close the menu.







#### Exit with confirmation

- S4  Press the button.  
 **JOB** The LED illuminates.  
 This action will automatically close the menu.

When a job is loaded and an UP/DOWN torch is installed, press the torch triggers to select the saved jobs.

### 13.3 DELETING A JOB

This function is available when welding mode is not active.

- S4  Hold down the button for 3 seconds.  
 **SA.** The message appears on the following displays: D1
- E1  Select the following setting with the encoder:  
 **Er.** The message appears only if there are saved JOBS, on the following displays: D1
- S4  Press the button to confirm.  
 **E.xx** The message appears on the following displays: D1



xx= number of the latest job used.

E1 Use the encoder to select the number of the job to be deleted.

#### Exit without confirmation

Press any button (except S4).

This action will automatically close the menu.

#### Exit with confirmation

S2 Press the button.

This action will automatically close the menu.

## 14 TORCH TRIGGER MODES

### 14.1 2T LIFT-ARC WELDING

1. Touch the workpiece with the torch electrode.
2. Press (1T) and keep the torch trigger pressed.
3. Slowly lift the torch to strike the arc.
  - The welding current reaches the preset value, by way of a up slope time, if programmed.
4. Release (2T) the trigger to start the weld completion procedure.
  - The current reaches the end current value in the time set in the down slope time parameter.
  - The arc is extinguished.
  - Gas delivery continues for the time set in the post gas parameter.

### 14.2 2T HF WELDING

1. Bring the torch up to the work until the electrode tip is approximately 2 or 3 mm away.
2. Press (1T) and keep the torch trigger pressed.
  - The arc strikes without contact with the workpiece and the voltage discharges (HF) cease automatically.
  - The welding current reaches the preset value, by way of a up slope time, if programmed.
3. Release (2T) the trigger to start the weld completion procedure.
  - The current reaches the end current value in the time set in the down slope time parameter.
  - The arc is extinguished.
  - Gas delivery continues for the time set in the post gas parameter.

### 14.3 4T LIFT-ARC WELDING

1. Touch the workpiece with the torch electrode.
2. Press (1T) and release (2T) the torch trigger.
3. Slowly lift the torch to strike the arc.
  - The welding current reaches the preset value, by way of a up slope time, if programmed.
4. Press (3T) the trigger and keep it pressed to start the weld completion procedure.
  - The current reaches the end current value in the time set in the down slope time parameter.
  - The arc continues and the current output will be the value set in the end current. parameter.
  - In these conditions the weld pool can be closed (crater filler current).
5. Release (4T) the trigger to extinguish the arc.
  - Gas delivery continues for the time set in the post gas parameter.



#### 14.4 4T HF WELDING

1. Bring the torch up to the work until the electrode tip is approximately 2 or 3 mm away.
2. Press (1T) and release (2T) the torch trigger.
  - ➡ The arc strikes without contact with the workpiece and the voltage discharges (HF) cease automatically.
  - ➡ The welding current reaches the preset value, by way of a up slope time, if programmed.
3. Press (3T) the trigger and keep it pressed to start the weld completion procedure.
  - ➡ The current reaches the end current value in the time set in the down slope time parameter.
  - ➡ The arc continues and the current output will be the value set in the end current. parameter.
  - ⓘ In these conditions the weld pool can be closed (crater filler current).
4. Release (4T) the trigger to extinguish the arc.
  - ➡ Gas delivery continues for the time set in the post gas parameter.

#### 14.5 BI-LEVEL LIFT WELDING

1. Touch the workpiece with the torch electrode.
2. Press (1T) and release (2T) the torch trigger.
3. Slowly lift the torch to strike the arc.
  - ➡ The welding current reaches the preset value, by way of a up slope time, if programmed.
4. Press and immediately release the torch trigger to switch to the second welding current.
  - ⓘ The trigger must not be pressed for more than 0.3 seconds; otherwise, the weld completion stage will start.
  - ⓘ When the trigger is pressed and released immediately, the system returns to the welding current.
5. Press (3T) the trigger and keep it pressed to start the weld completion procedure.
  - ➡ The current reaches the end current value in the time set in the down slope time parameter.
  - ➡ The arc continues and the current output will be the value set in the end current. parameter.
  - ⓘ In these conditions the weld pool can be closed (crater filler current).
6. Release (4T) the trigger to extinguish the arc.
  - ➡ Gas delivery continues for the time set in the post gas parameter.

#### 14.6 BI-LEVEL HF WELDING

1. Bring the torch up to the work until the electrode tip is approximately 2 or 3 mm away.
2. Press (1T) and release (2T) the torch trigger.
  - ➡ The arc strikes without contact with the workpiece and the voltage discharges (HF) cease automatically.
  - ➡ The welding current reaches the preset value, by way of a up slope time, if programmed.
3. Press and immediately release the torch trigger to switch to the second welding current.
  - ⓘ The trigger must not be pressed for more than 0.3 seconds; otherwise, the weld completion stage will start.
  - ⓘ When the trigger is pressed and released immediately, the system returns to the welding current.
4. Press (3T) the trigger and keep it pressed to start the weld completion procedure.
  - ➡ The current reaches the end current value in the time set in the down slope time parameter.
  - ➡ The arc continues and the current output will be the value set in the end current. parameter.
  - ⓘ In these conditions the weld pool can be closed (crater filler current).
5. Release (4T) the trigger to extinguish the arc.
  - ➡ Gas delivery continues for the time set in the post gas parameter.

#### 14.7 2T SPOT WELDING

1. Touch the workpiece with the torch electrode.
2. Press (1T) and keep the torch trigger pressed.
3. Slowly lift the torch to strike the arc.
4. Release (2T) the torch trigger.
  - ➡ The welding current reaches the preset value, by way of a up slope time, if programmed.
  - ➡ The welding procedure continues, at the preset current, for the time set with the spot time parameter.
  - ➡ The current reaches the end current value in the time set in the down slope time parameter.
  - ➡ The arc is extinguished.
  - ➡ Gas delivery continues for the time set in the post gas parameter.



## 14.8 2T SPOT HF WELDING

### Press and release torch trigger procedure

1. Bring the torch up to the work until the electrode tip is approximately 2 or 3 mm away.
2. Press (1T) the torch trigger.
  - ➡ The arc strikes without contact with the workpiece and the voltage discharges (HF) cease automatically.
3. Release (2T) the torch trigger.
  - ➡ The welding current reaches the preset value, by way of a up slope time, if programmed.
  - ➡ The welding procedure continues, at the preset current, for the time set with the spot time parameter.
  - ➡ The current reaches the end current value in the time set in the down slope time parameter.
  - ➡ The arc is extinguished.
  - ➡ Gas delivery continues for the time set in the post gas parameter.

### Keep pressed torch trigger procedure

Bring the torch up to the work until the electrode tip is approximately 2 or 3 mm away.

Press (1T) the torch trigger.

- ➡ The arc strikes without contact with the workpiece and the voltage discharges (HF) cease automatically.
- ➡ The welding current reaches the preset value, by way of a up slope time, if programmed.
- ➡ The welding procedure continues, at the preset current, for the time set with the spot time parameter.
- ➡ The current reaches the end current value in the time set in the down slope time parameter.
- ➡ The arc is extinguished.
- ➡ Gas delivery continues for the time set in the post gas parameter.

Touch the workpiece with the torch electrode.

Slowly lift the torch to strike the arc.

## 14.9 PILOT ARC WELDING

The pilot arc can be activated in the following torch trigger procedures:

- 4T LIFT-ARC WELDING
- 4 TIMES + HF WELDING (4T HF)
- 4 TIMES BI-LEVEL + HF WELDING (4T BI-LEVEL HF)

The welding procedure with pilot arc differs with respect to the procedure without pilot arc in the part of the torch trigger procedure described below.

### LIFT-ARC Welding

Touch the workpiece with the torch electrode.

Press (1T) and keep the torch trigger pressed.

Slowly lift the torch to strike the arc.

- ➡ The arc strikes, the welding current assumes the pilot current value.

Release (2T) the torch trigger.

- ➡ The welding current reaches the preset value, by way of a up slope time, if programmed.

etc.

### Welding with HF

Press (1T) and keep the torch trigger pressed.

- ➡ The arc strikes without contact with the part and the voltage discharges (HF) cease automatically, the welding current will assume the pilot current value.





Release (2T) the torch trigger.

- ➡ The welding current reaches the preset value, by way of a up slope time, if programmed.

etc.

## 15 TECHNICAL DATA

Model	Multi Power 204T
Construction standards	EN 60974-1
	EN 60974-3
	EN 60974-10 Class A
Supply voltage	1 x 230V~ ± 15 % / 50-60 Hz 1 x 115V~ ± 15 % / 50-60 Hz
Dimensions ( L x D x H )	400 x 160 x 260 mm
Weight	9.8 kg
Insulation class	H
Protection rating	IP23S
Cooling	AF
Maximum gas pressure	0.5 MPa (5 bar)
Z <sub>max</sub>	Compliant with EN 61000-3-12 Hook-up not dependent on the supply network

Supply voltage	1 x 230V~ ± 15 % / 50-60 Hz						1 x 115V~ ± 15 % / 50-60 Hz				
Mains protection	16 A Delayed						32 A Delayed				
Temperature of the environment	40°C						40°C				
Welding mode	MMA			TIG			MMA		TIG		
Static characteristic											
Work cycle	35 %	60 %	100 %	30 %	60 %	100 %	50 %	60 %	100 %	-	100 %
Welding current	180 A	130 A	120 A	200 A	140 A	130 A	115 A	110 A	105 A	-	115 A
Working voltage	27.2 V	25.2 V	24.8 V	18.0 V	15.6 V	15.2 V	24.6 V	24.4 V	24.2 V	-	14.6 V
Maximum input power	5.8 KVA	4.0 KVA	3.6 KVA	4.6 KVA	2.9 KVA	2.6 KVA	3.5 KVA	3.3 KVA	3.1 KVA	-	2.2 KVA
Maximum input power	5.6 KW	3.8 KW	3.4 KW	4.3 KW	2.6 KW	2.4 KW	3.3 KW	3.2 KW	3.0 KW	-	2.1 KW
Maximum supply current	25.3 A	17.3 A	15.4 A	19.6 A	12.2 A	11.1 A	29.3 A	28.2 A	27.0 A	-	18.5 A
Maximum effective current	15.0 A	13.4 A	15.4 A	10.7 A	9.5 A	11.1 A	20.7 A	21.8 A	27.0 A	-	18.5 A
No-load voltage (U <sub>0</sub> )	83 V			83 V			83 V		83 V		
Reduced No-load voltage (U <sub>r</sub> )	11 V			11 V			11 V		11 V		
Arc striking device designed to work with manual guided torch.											
Rated HF peak voltage							11.3 kV				

# 16 SPARE PARTS

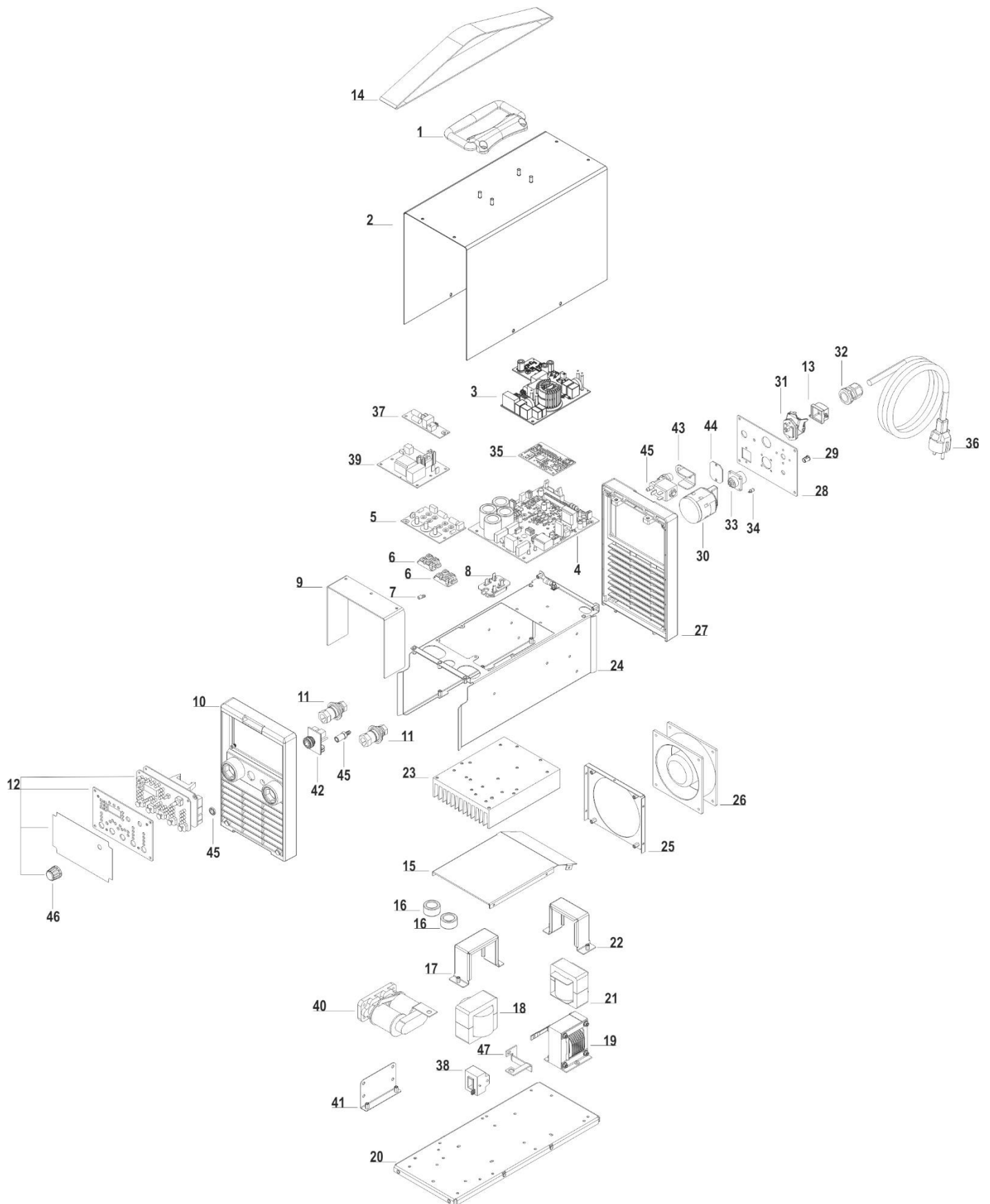

N°	CODE	DESCRIPTION
1	011.0006.0031	HANDLE
2	011.0000.0121	UPPER COVER
3	050.0002.0165	LINE FILTER BOARD
4	050.0003.0169	COMPLETE POWER BOARD (with board .0166)
5	050.0002.0098	SNUBBER BOARD
6	032.0002.2403	ISOTOP DIODE
7	040.0003.1008	TERMAL SWITCH
8	050.0001.0154	PRIMARY RECTIFIER BOARD
9	046.0004.0009	TUNNEL PLASTIC INSULATION
10	010.0006.0043	COMPLETE FRONT PLASTIC PANEL
11	021.0001.0260	FIXED SOCKET 400A
12	050.5031.0000	COMPLETE LOGIC FRONT PANEL
13	021.0013.0007	ILME CONNECTOR CAP (OPTIONAL WITH KIT CU-204T)
14	005.0001.0004	BELT
15	011.0003.0054	VENTILATION SHROUD
16	043.0002.0621	OUTPUT TOROIDAL FILTER
17	011.0003.0057	BOOST INDUCTANCE SUPPORT
18	044.0004.0017	BOOST INDUCTANCE
19	044.0004.0031	OUTPUT INDUCTANCE
20	011.0003.0051	LOWER COVER
21	042.0003.0043	POWER TRANSFORMER
22	011.0003.0056	TRANSFORMER SUPPORT
23	015.0001.0018	HEAT SINK
24	011.0003.0052	TUNNEL HOUSING
25	011.0003.0053	FAN SUPPORT
26	003.0002.0017	FAN
27	010.0006.0042	COMPLETE REAR PLASTIC PANEL
28	013.0014.0400	REAR PANEL
29	016.4107.0001	LED HOLDER
30	040.0001.0011	TWO-POLE SWITCH
31	022.0002.0245	C.U. POWER SUPPLY WIRING (OPTIONAL WITH KIT CU-204T)
32	045.0000.0014	CABLE CLAMP
33	022.0002.0005	REMOTE CONTRO WIRING
34	022.0002.0206	LED WIRING
35	050.0002.0166	INVERTER + CONTROL BOOST BOARD
36	045.0002.0008	NEOPRENE SUPPLY CABLE
37	050.0002.0103	OUTPUT FILTER BOARD
38	041.0004.0301	CURRENT SENSOR
39	050.0003.0027	HF BOARD
40	010.0002.0004	COMPLETE HF TRANSFORMER
41	011.0003.0058	HF SUPPORT PLATE
42	050.0002.0153	TORCH CONNECTOR
43	011.0002.0018	SOLENOID VALVE PLATE
44	011.0016.0125	C.U. CONNECTION COVER PLATE
45	010.0001.0010	COMPLETE SOLENOID VALVE

46	014.0002.0002	KNOB WITH CUP WITHOUT INDICATOR
47	045.0006.0123	CURRENT SENSOR BRACKET

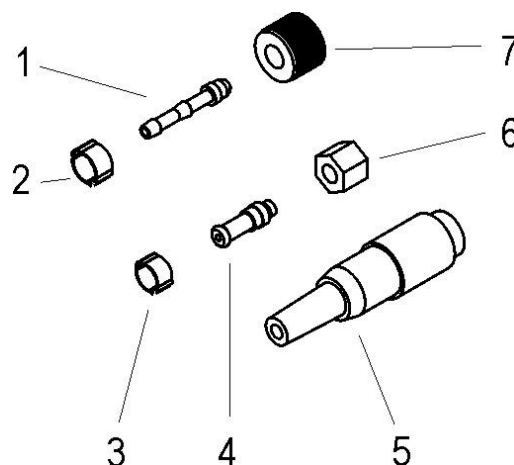

N°	CODE	DESCRIPTION
	021.0000.0001	GAS CONNECTIONS COMPLETE KIT 0001
1	016.5001.0822	SLEEVE HOSE ADAPTER FOR RUBBER HOSE
2	016.0007.0001	HOSE CLAMP Ø=11-13
3	016.0007.0709	HOSE CLAMP Ø=07-09
4	016.5001.0821	SLEEVE HOSE ADAPTER FOR RUBBER HOSE M10
5	021.0004.3360	AMPHT3360-001 M/5V. VOL. CONNECTOR
6	016.5001.1311	NUT M10
7	016.5001.0823	NUT 1/4

# 17 ELECTRICAL DIAGRAM

## 17.1 MULTI POWER 204T

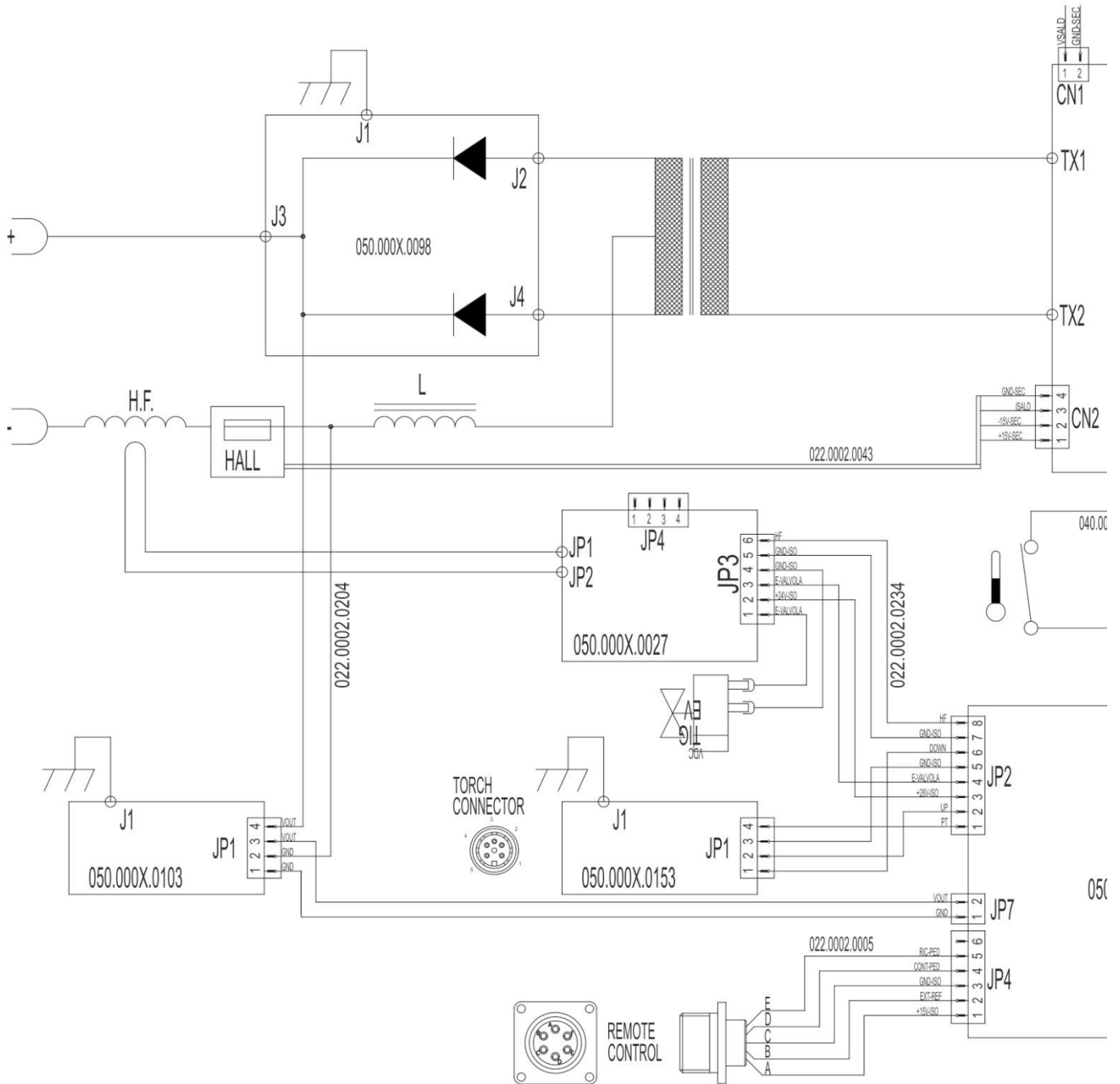



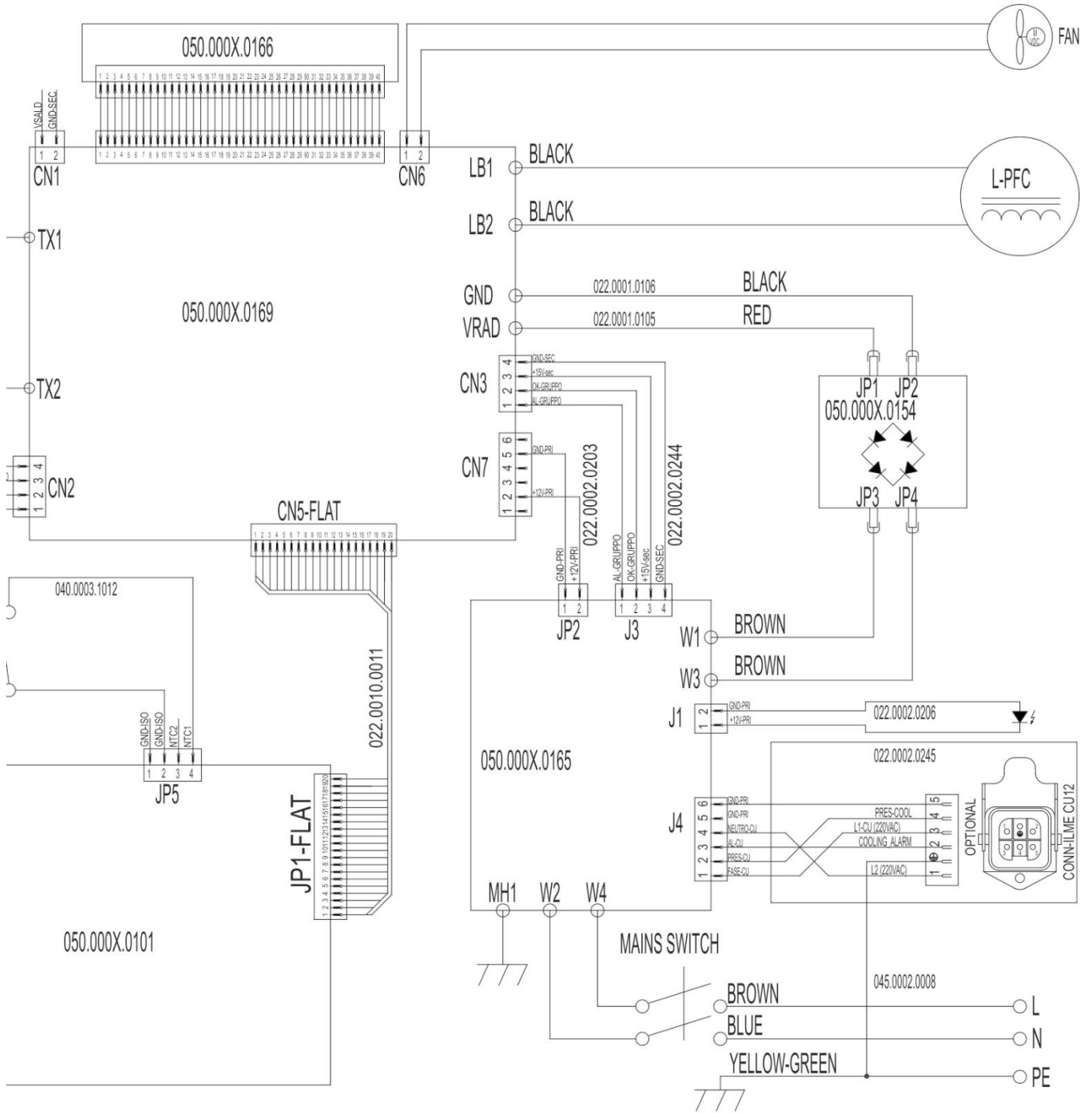

**17.2 TORCH CONNECTOR**

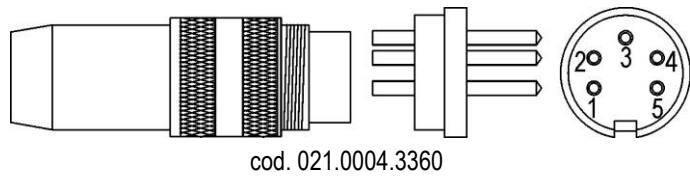

**Torch**

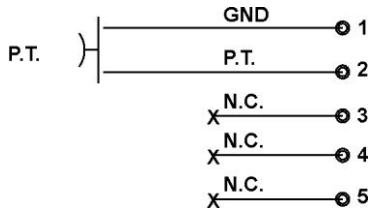

**Up & Down Torch**

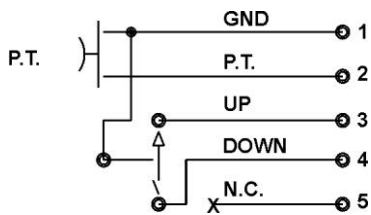

**17.3 REMOTE CONTROLLER CONNECTOR**

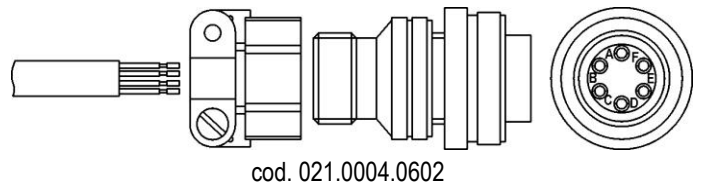

**Torch with potentiometer**

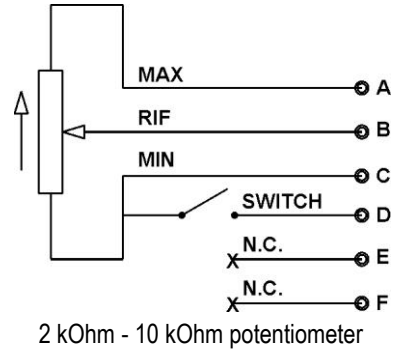

**Remote Controller**

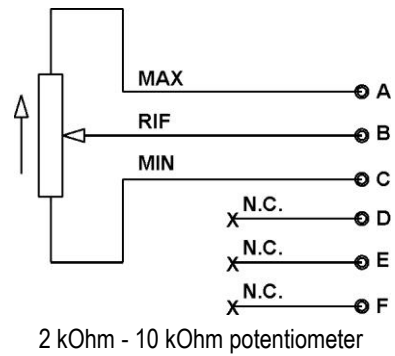

**Foot pedal controller**

