

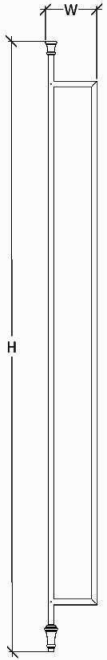

FITTINGS

METAL COLLECTION



CEILING MOUNT

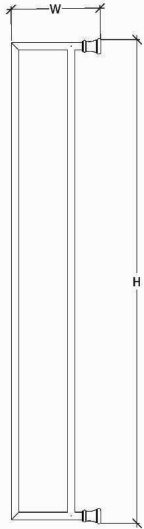

DUAL MOUNT

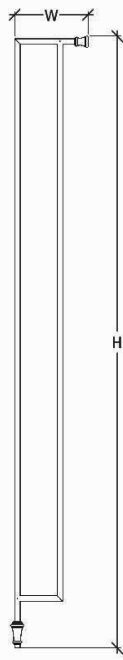

WALL MOUNT

BRACKETS

- A.** Mount collars to surface blocking or ceiling blocking and affix by screwing into place.

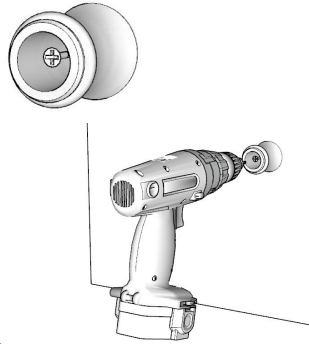

- B.** Place set screw in outer hole (facing set screw where it will be least visible). Slide end panel into collar.

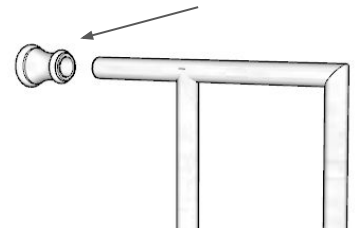

- C.** Tighten set screw against the end panel to secure into place.

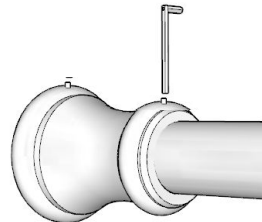

- D.** Rotate at the base to adjust foot. Size ranging $\frac{1}{4}$ " shorter and $\frac{3}{4}$ " longer than stated size.

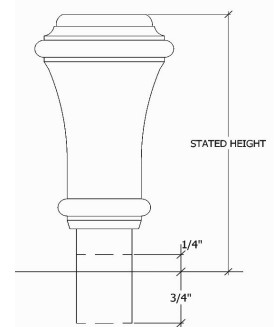

- E.** *Optional: For additional support-foot can be secured to floor. Screw nylon bushing into desired location.

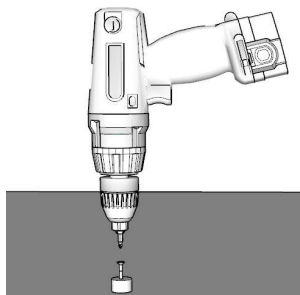

- F.** *Optional: Foot sleeve fits over nylon bushing to secure to floor.

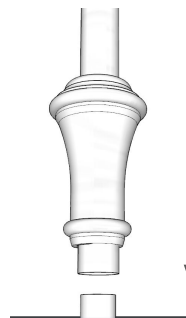

- G.**

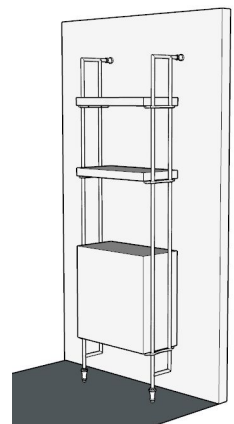



FITTINGS

METAL COLLECTION

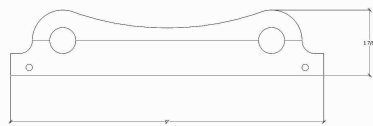

END PLATE

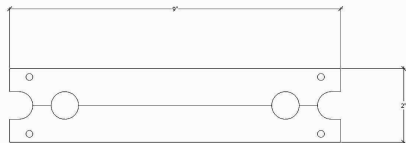

JOINING PLATE

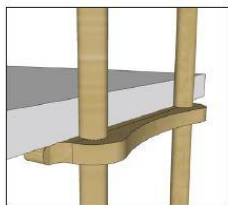

UNDERMOUNT

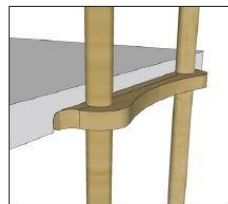

RABBETED

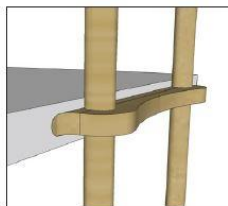

MORTISED

BRACKET ATTACHMENT PLATES

- A.** Locate the flat side of the attachment plate containing holes for screws.

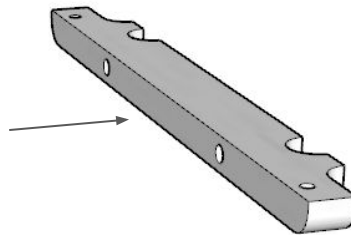

- B.** Place each half of the attachment plate independently around the metal bracket rod in the center spaces provided.

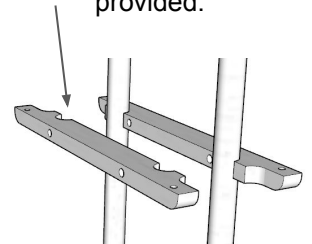

- C.** With each half of the attachment plate pressed together, tighten to secure plate.

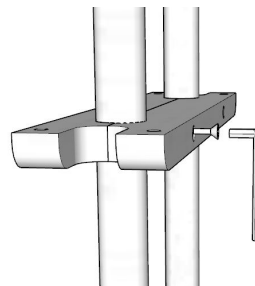

- D.** Drill screws through the bottom of the attachment plate into shelving or cabinets.

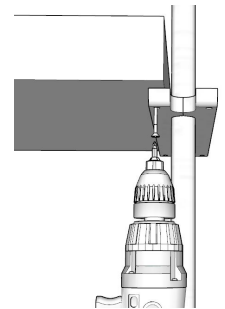

- E.** Note: Before mounting shelves or cabinets - be sure to have two level bracket attachments in place prior to placement of product.

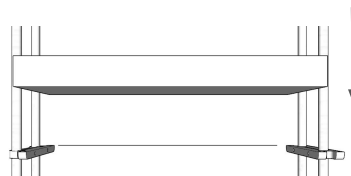

- F.**

