

PLEASE READ THIS MANUAL IN ITS ENTIRETY PRIOR TO USING THIS PRODUCT!

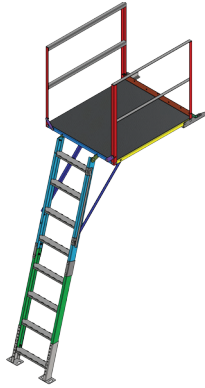

USA MADE ELEVATOR STAIR PLATFORM INSTRUCTION MANUAL (UPC 897909000121)



SUMMIT OUTDOORS USA MADE ELEVATOR STAIR PLATFORM



WARNING! DO NOT erect this Summit Outdoors product near power transmission lines or any other high voltage source. Failure to follow these instructions may result in serious injury or death!



WARNING! DO NOT use this Summit Outdoors product when lightning is within 2 miles of your location. If lightning is threatening, climb down and seek safe shelter. Failure to follow these instructions may result in serious injury or death!

WARNING! This USA Made Elevator Stair Platform is designed to be used with the optional Summit Outdoors USA Made Elevator Tower or the Summit Outdoors Elevator Bracket System (sold separately). DO NOT attempt to use this product with any other platform system or as a stand-alone unit. Failure to follow these instructions may result in serious injury or death!



ATTENTION

YOU MUST READ ALL WRITTEN INSTRUCTIONS AND WATCH THIS SAFETY VIDEO BEFORE USING!



WATCH THIS SAFETY VIDEO BEFORE USING!

Scan →



or Visit → www.standsafety.com/sh21

Scan the QR code with your smart phone, tablet or similar device.

OR

Type the website address into your web browser to view an important safety video before using this product.

ELEVATED BLIND SAFETY

Model Number and Maximum Total Weight Capacity

Summit Outdoors USA MADE ELEVATOR STAIR PLATFORM 700-pounds (318 kg) (User(s) and Equipment)



WARNING! This product carries strict weight limitations. Do not use this product if you exceed this total weight limitation. Please note this weight limit includes the user and equipment. Failure to follow these instructions may result in serious injury or death!

Thank you for your purchase of this quality Summit Outdoors product. To ensure your personal safety, please take a moment to carefully read this product Instruction Manual in its entirety before attempting to set-up, install and/or otherwise use this Summit Outdoors product. Failure to do so could result in serious personal injury or death! These instruction should be kept in a safe place and reviewed at least annually.

Should you have any questions about the installation and/or use of this product, or any other Summit Outdoors product(s) do not hesitate to call one of our customer service representatives at 888-446-4868 or visit us online at shadowhunterblinds.com. Our service representatives will answer any questions you may have about any of the complete line of Summit Outdoors products.



Assembly Time
Approximately 15 Minutes

Check for parts online at shadowhunterblinds.com or call 888-446-4868 M-F 8-5 CT

1 03/24

PLEASE READ THIS MANUAL IN ITS ENTIRETY PRIOR TO USING THIS PRODUCT!

PLEASE READ THIS MANUAL IN ITS ENTIRETY PRIOR TO USING THIS PRODUCT!















PLEASE READ THIS MANUAL IN ITS ENTIRETY PRIOR TO USING THIS PRODUCT!



ATTENTION!!

WHEN YOU SEE A "WARNING!" BE SURE TO HEED THE MESSAGE! THE INFORMATION CONTAINED IN THESE MESSAGES CAN SAVE YOUR LIFE!!









-  When hunting from, installing, or removing a treestand, tripod, or tower, falls can occur any time after leaving the ground causing injury or death.
-  Read and understand all of the manufacturer's Warnings and Instructions and use all safety devices provided by the manufacturer. Contact the manufacturer for any questions. Failure to do so could result in injury or death.
-  Never exceed the total weight limit of the treestand, tripod, or tower.
-  Never use, install, or remove a treestand, tripod, or tower during inclement weather such as rain, lightning, windstorms or icy conditions and end your hunt and return to the ground if inclement conditions arise.
-  Never use, install, or remove a treestand, tripod, or tower while using drugs (even prescription drugs) or alcohol.
-  Never use, install, or remove a treestand, tripod, or tower while feeling ill, nauseous or dizzy, or if you have a prior medical condition that could cause a problem, that is, heart condition, joints that lock-up, spinal fusions, etc., or if you are not well rested.
-  Never use, install, or remove a treestand on a dead, leaning, diseased or loose barked tree, or a utility pole.
-  Never rely on a tree branch for support.
-  Always inform someone of the hunting location, where the treestand, tripod, or tower will be located and the expected duration of the hunt.
-  A signal device such as a mobile phone, radio, whistle, signal flare or personal locator device (PLD) must be on your person and readily available at all times.
-  Inspect the treestand, tripod, or tower and all safety devices each time before use and do not store a treestand outdoors.
-  Never modify your treestand, tripod, or tower in any way by making repairs, replacing parts, or altering it unless explicitly authorized in writing by the manufacturer.
-  Instructions (written and video) shall be kept in a safe place and reviewed at least annually. It is the responsibility of the treestand, tripod, or tower owner to furnish the complete instructions to any person who borrows or purchases the treestand, tripod, or tower.
-  When using a tripod or tower stand the risk of a fall can occur anytime after leaving the ground. Falling from a tripod or tower stand can result in serious injury or death.
-  Inspect tripod and tower stands before each use. Leaving equipment exposed to rain, sunlight, changing temperatures, snow and extreme weather conditions for extended periods of time can cause dangerous conditions not visible to the naked eye. Do not attempt to use any product if damage is detected or suspected. For your personal safety and also the safety of others, the product should be removed from service immediately.



ATTENTION!!
WHEN YOU SEE A "WARNING!" BE SURE TO HEED THE MESSAGE! THE INFORMATION CONTAINED
IN THESE MESSAGES CAN SAVE YOUR LIFE!!



-  When installing, taking down or moving a tripod or tower stand you must strictly follow the manufacturer's instructions to determine the appropriate number of people required to perform these tasks (at least 4 people or more).
-  Prior to setting up your tripod or tower stand inspect the ground surface area. The ground must be firm, level and free of any debris. Soft or sloping ground and debris can cause the platform to become unstable and lead to unsafe conditions such as tilting, shifting or tipping. Never attempt to climb a tripod or tower stand that is leaning, unstable or slanted.
-  Never erect a tripod or tower stand near overhead electrical power lines or buried utilities, or both, that can cause electrocution, explosion, or fire, or a combination thereof. You must always contact appropriate authorities prior to installing any structure on or near right of ways or underground utilities.
-  For towers and tripods designed for two or more people, never allow more than one person at a time to ascend or descend the ladder. Be certain first person is fully off the ladder/entry platform and positioned safely on tower platform or ground before second person ascends or descends ladder.
-  Always maintain three (3) points of contact when climbing a tripod or tower stand. Proper three-point contact means having either two feet with one hand or one foot with two hands on the step portion of the ladder at all times. Never lean backward when climbing as this could cause the tripod or tower stand to become unstable.
-  Tripod and tower stands must be properly secured or anchored, or both, to the ground according to manufacturer's instructions. Avoid using tripod and tower stands during windy conditions which could cause the free standing platform to tip over and result in damage to equipment and also serious injury or death to the users.



**SUMMIT
OUTDOORS**



WATCH THIS SAFETY VIDEO BEFORE USING!



www.standsafety.com/sh21

ELEVATED BLIND SAFETY

INSPECTION AND MAINTENANCE SCHEDULE

BEFORE EACH USE PERFORM THE FOLLOWING:

- Inspect all webbing, rope, cord, and strap assemblies for wear or damage.
- Inspect all hardware and chain components for damage.
- Inspect for any structural damage to product. (If any exists call SUMMIT OUTDOORS customer service at 888-446-4868.)
- Inspect all nut and bolt assemblies to be certain none are loose.
- Inspect for any missing parts.
- Inspect product for any rust, corrosion, cracks, affects of freezing, excessive heat or rotting damage that may effect the safety of your product. Remove from service any product found to be defective or damaged. DO NOT reuse.
- Inspect entire product for any structural damage. Be certain to inspect visible welds for any signs of deformation or failure. Remove from service any product found to be defective or damaged. DO NOT reuse.
- Inspect all nut & bolt assemblies and locations. Tighten any that may be loose. Be careful not to crush tubing when tightening.
- Inspect and check operation of all cables, cable ends, cord, rope, webbing, and strap or chain assemblies. Replace with factory new any item or assembly that shows signs of wear, damage, kinking, or functions incorrectly.
- Inspect all hardware for wear or damage, also be certain there are no missing parts. NOTE: Animals, vandals, etc. can negatively affect the performance of your Summit Outdoors product. Inspect it prior to every use for potential damage caused by these. Remove from service any product found to be defective or damaged. DO NOT reuse.
- Never modify your Summit Outdoors product in any manner by making repairs, replacing parts, or altering adding or attaching anything to it unless explicitly authorized in writing by the manufacturer.

OPTIONAL ACCESSORIES AND REPLACEMENT PARTS

Any number of innovative accessories are available and sold separately to compliment your new climbing system. Only genuine authorized accessories shall be used with your climbing/treestand system. Genuine replacement parts are also available online or via telephone. Should you require parts or service, or if you just have a question about this, or any other product(s), simply give one of our customer service representatives a call 888-446-4868 or visit us online at shadowhunterblinds.com.



PLEASE READ THIS MANUAL IN ITS ENTIRETY PRIOR TO USING THIS PRODUCT!

PARTS LIST

**INCLUDED HARDWARE
(NOT TO SCALE):**



QTY: 45

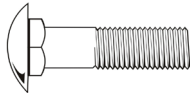

QTY: 45



QTY: 12

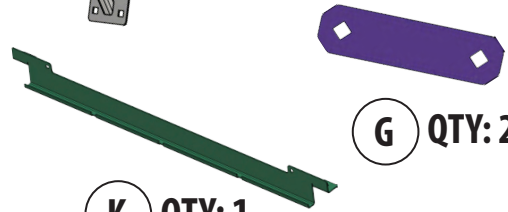
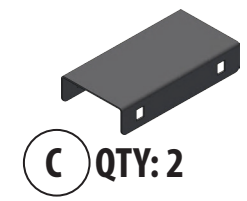
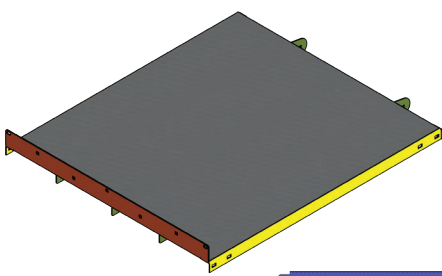
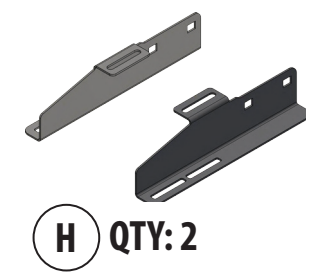
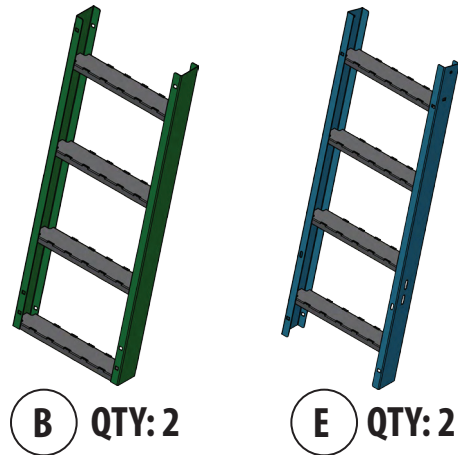
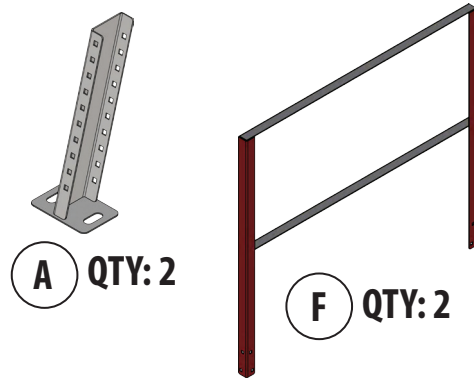
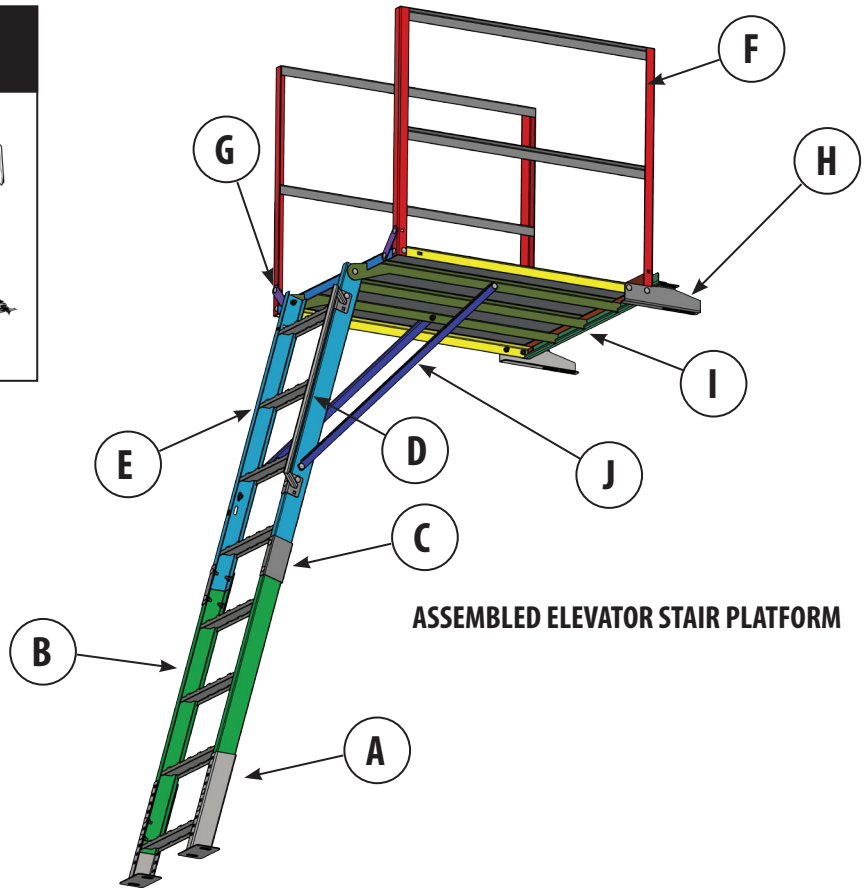

PARTS NOT TO SCALE

Check for parts online at shadowhunterblinds.com or call 888-446-4868 M-F 8-5 CT

PLEASE READ THIS MANUAL IN ITS ENTIRETY PRIOR TO USING THIS PRODUCT!

ASSEMBLY INSTRUCTIONS

Prior to using your Summit Outdoors product you must perform some assembly.

All assembly must be done in strict accordance with these instructions. Omitting or skipping any STEPS will result in product damage and potential product failure and may result in serious injury or death!

Do not remove labels/warnings from product, they are there for your safety. This product is recommended for adult use only. No one under the age of 18-years old should attempt to assemble or use this product without direct adult supervision.



WARNING! Only use approved Summit Outdoors parts included with this Summit Outdoors product. Parts substitution or omission may result in serious injury or death!

STEP 1:

COMPLETE THIS STEP FOR THE LADDER PLATFORM ASSEMBLY

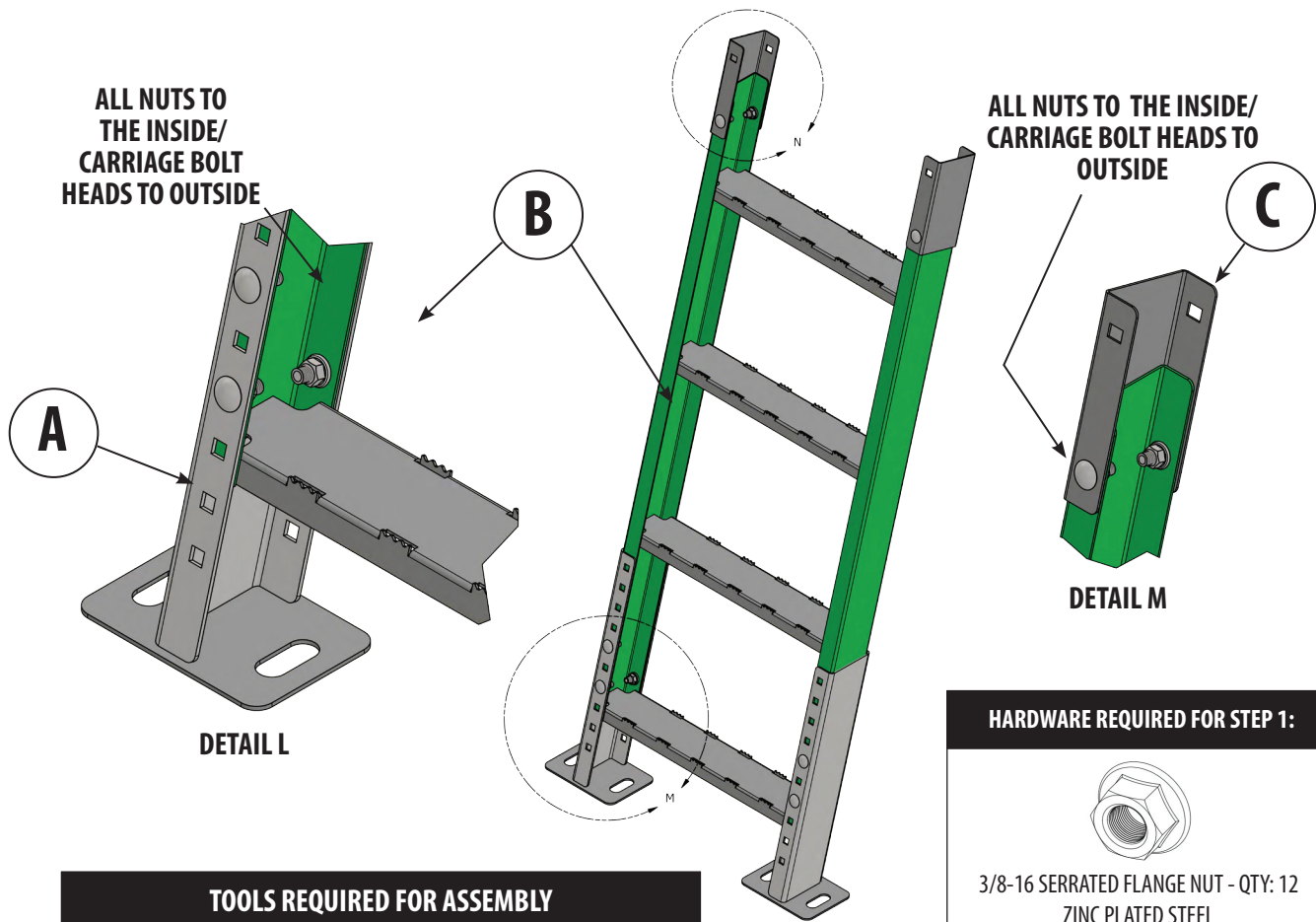

ALL NUTS TO THE INSIDE/
CARRIAGE BOLT HEADS TO OUTSIDE

ALL NUTS TO THE INSIDE/
CARRIAGE BOLT HEADS TO OUTSIDE

A

B

C

DETAIL L

DETAIL M

HARDWARE REQUIRED FOR STEP 1:



3/8"-16 SERRATED FLANGE NUT - QTY: 12
ZINC PLATED STEEL
(NOT TO SCALE)

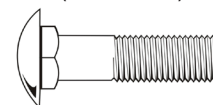

3/8"-16 1" LONG CARRIAGE BOLT - QTY: 12
ZINC PLATED STEEL
(NOT TO SCALE)

TOOLS REQUIRED FOR ASSEMBLY



9/16" BOX WRENCH

Make certain the carriage bolts are seated prior to tightening.

Unseated bolts will result in damage to the structural members and bolts. Tighten nuts snugly ensuring they are tight.

DO NOT overtighten nuts as this may damage the hardware.

Check for parts online at shadowhunterblinds.com or call 888-446-4868 M-F 8-5 CT



WARNING! Only use approved Summit Outdoors parts included with this Summit Outdoors product. Parts substitution or omission may result in serious injury or death!

PLEASE READ THIS MANUAL IN ITS ENTIRETY PRIOR TO USING THIS PRODUCT!

PLEASE READ THIS MANUAL IN ITS ENTIRETY PRIOR TO USING THIS PRODUCT!

STEP 2:

COMPLETE THIS STEP TO INSTALL THE GRAB HANDLE

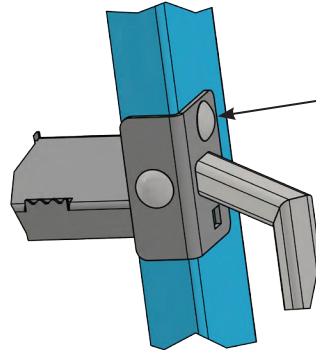
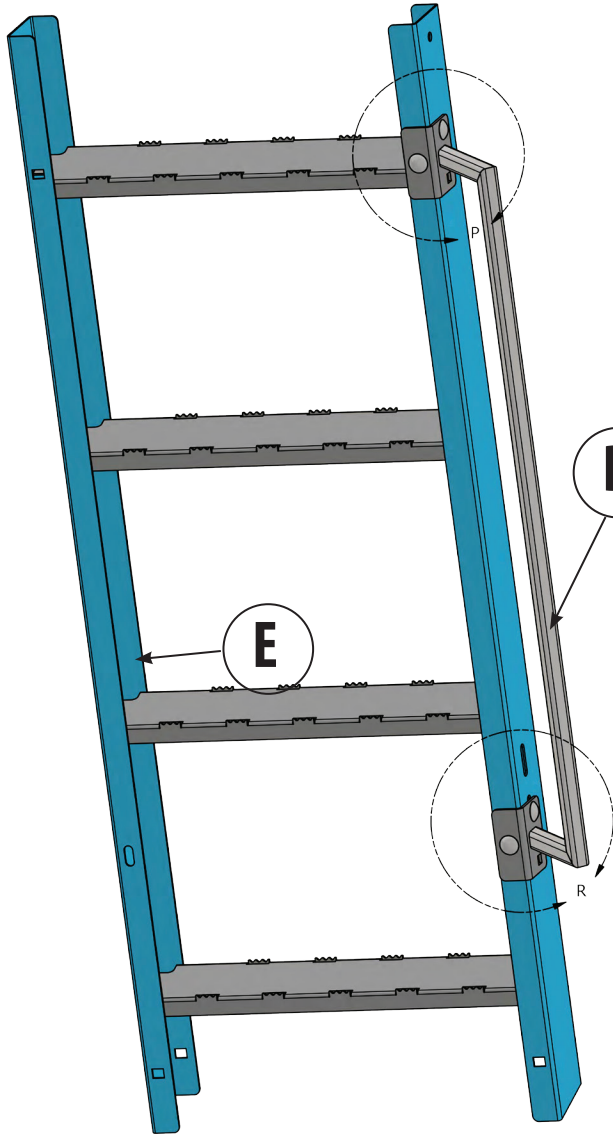

DETAIL N

ALL NUTS TO THE INSIDE/
CARRIAGE BOLT HEADS TO OUTSIDE

D

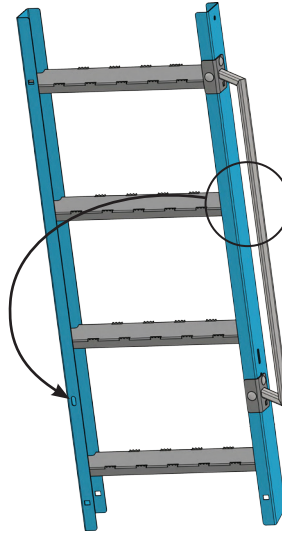

NOTE: GRAB HANDLE CAN BE INSTALLED ON EITHER SIDE

THIS SLOT FOR ANGLE BRACE TO PLATFORM

INSTALL ON LOWER SLOT

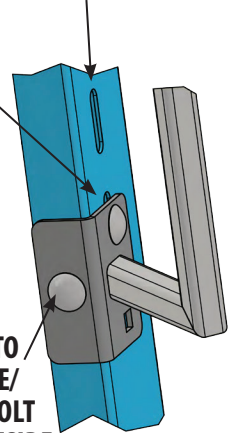

DETAIL P

ALL NUTS TO THE INSIDE/
CARRIAGE BOLT HEADS TO OUTSIDE

TOOLS REQUIRED FOR ASSEMBLY



9/16" BOX WRENCH

Make certain the carriage bolts are seated prior to tightening.
Unseated bolts will result in damage to the structural members and bolts. Tighten nuts snugly ensuring they are tight.

DO NOT overtighten nuts as this may damage the hardware.

Check for parts online at shadowhunterblinds.com or call 888-446-4868 M-F 8-5 CT

HARDWARE REQUIRED FOR STEP 2:



3/8"-16 SERRATED FLANGE NUT - QTY: 4
ZINC PLATED STEEL
(NOT TO SCALE)

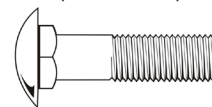

3/8"-16 1" LONG CARRIAGE BOLT - QTY: 4
ZINC PLATED STEEL
(NOT TO SCALE)



WARNING! Only use approved Summit Outdoors parts included with this Summit Outdoors product. Parts substitution or omission may result in serious injury or death!

STEP 3:

COMPLETE THIS STEP FOR ADDING HAND RAILS (2), CORNER GUSSETS (2) AND PLATFORM ATTACHMENT BRACKETS (2)

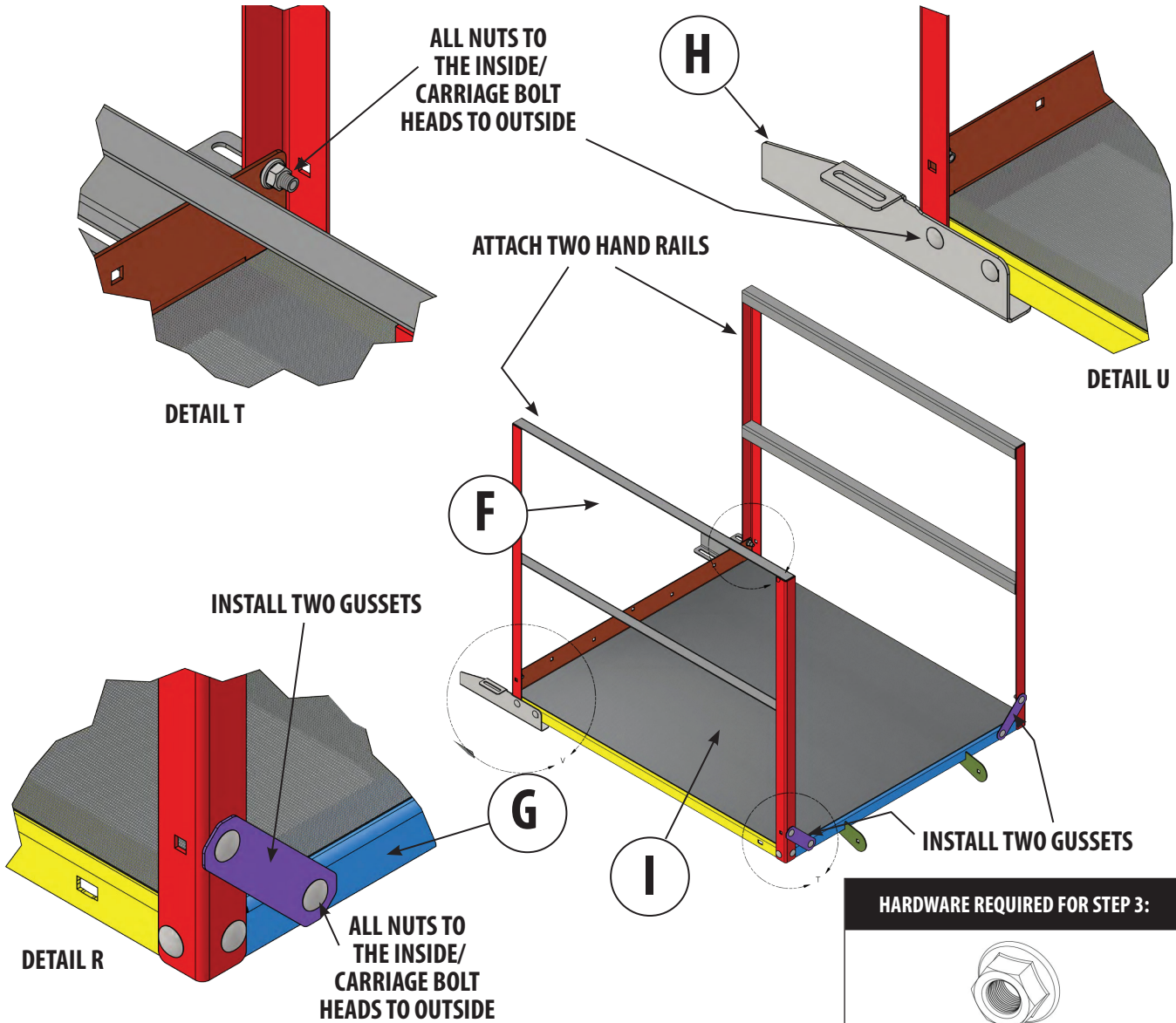

TOOLS REQUIRED FOR ASSEMBLY

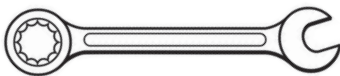

9/16" BOX WRENCH

Make certain the carriage bolts are seated prior to tightening.
 Unseated bolts will result in damage to the structural members and bolts. Tighten nuts snugly ensuring they are tight.
 DO NOT overtighten nuts as this may damage the hardware.

HARDWARE REQUIRED FOR STEP 3:



3/8"-16 SERRATED FLANGE NUT - QTY: 10
 ZINC PLATED STEEL
 (NOT TO SCALE)

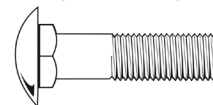

3/8"-16 1" LONG CARRIAGE BOLT - QTY: 10
 ZINC PLATED STEEL
 (NOT TO SCALE)

Check for parts online at shadowhunterblinds.com or call 888-446-4868 M-F 8-5 CT

PLEASE READ THIS MANUAL IN ITS ENTIRETY PRIOR TO USING THIS PRODUCT!

PLEASE READ THIS MANUAL IN ITS ENTIRETY PRIOR TO USING THIS PRODUCT!



WARNING! Only use approved Summit Outdoors parts included with this Summit Outdoors product. Parts substitution or omission may result in serious injury or death!

PLEASE READ THIS MANUAL IN ITS ENTIRETY PRIOR TO USING THIS PRODUCT!

PLEASE READ THIS MANUAL IN ITS ENTIRETY PRIOR TO USING THIS PRODUCT!

STEP 4:

SECURE TWO LADDER SECTIONS TOGETHER AND INSTALL TWO PIVOT BOLTS

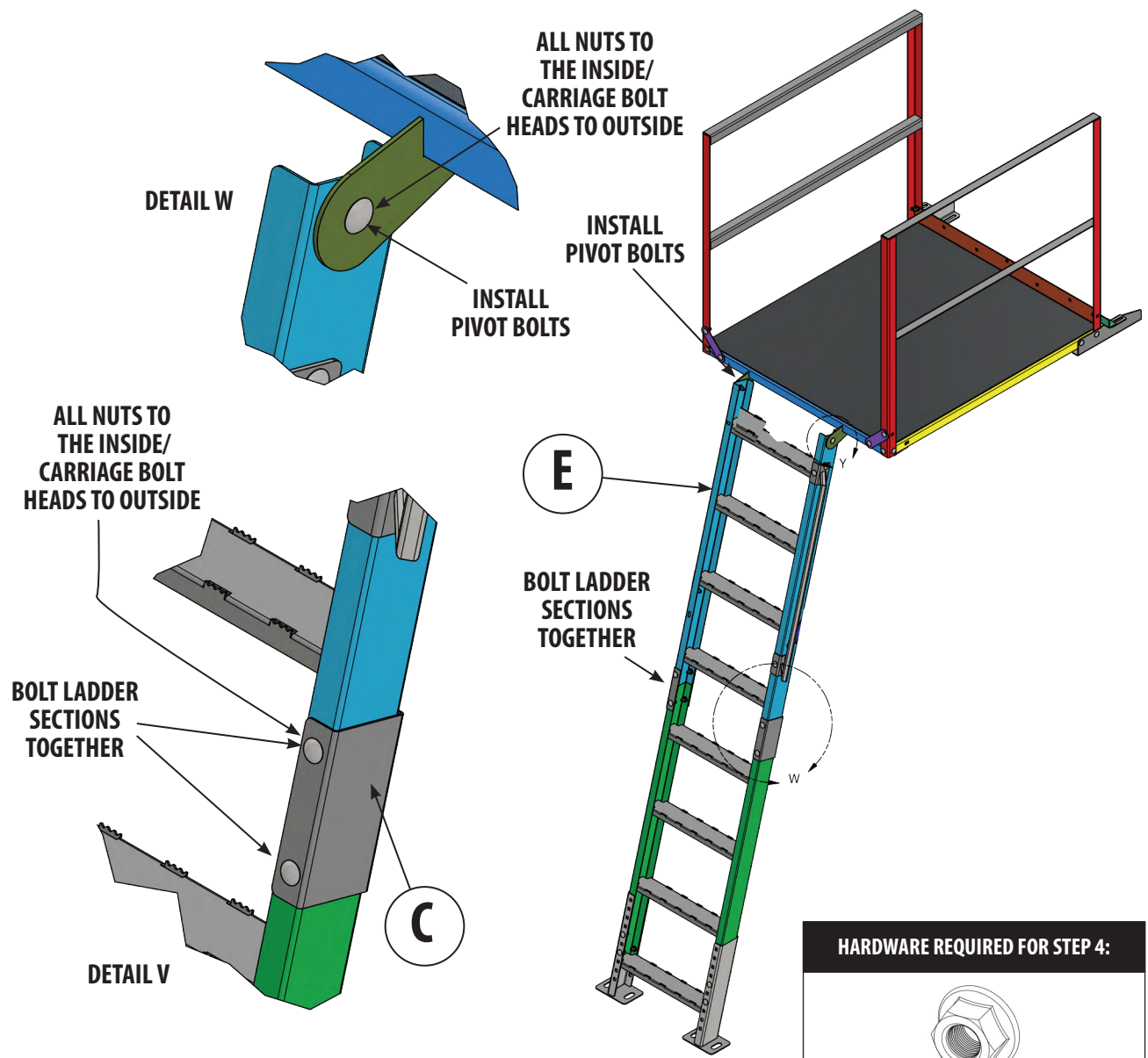

TOOLS REQUIRED FOR ASSEMBLY

9/16" BOX WRENCH

Make certain the carriage bolts are seated prior to tightening.
 Unseated bolts will result in damage to the structural members and bolts. Tighten nuts snugly ensuring they are tight.
 DO NOT overtighten nuts as this may damage the hardware.

HARDWARE REQUIRED FOR STEP 4:

3/8-16 SERRATED FLANGE NUT - QTY: 10
 ZINC PLATED STEEL
 (NOT TO SCALE)

3/8"-16 1" LONG CARRIAGE BOLT - QTY: 10
 ZINC PLATED STEEL
 (NOT TO SCALE)

Check for parts online at shadowhunterblinds.com or call 888-446-4868 M-F 8-5 CT



WARNING! Only use approved Summit Outdoors parts included with this Summit Outdoors product. Parts substitution or omission may result in serious injury or death!

STEP 5:

INSTALL TWO ANGLE BRACES

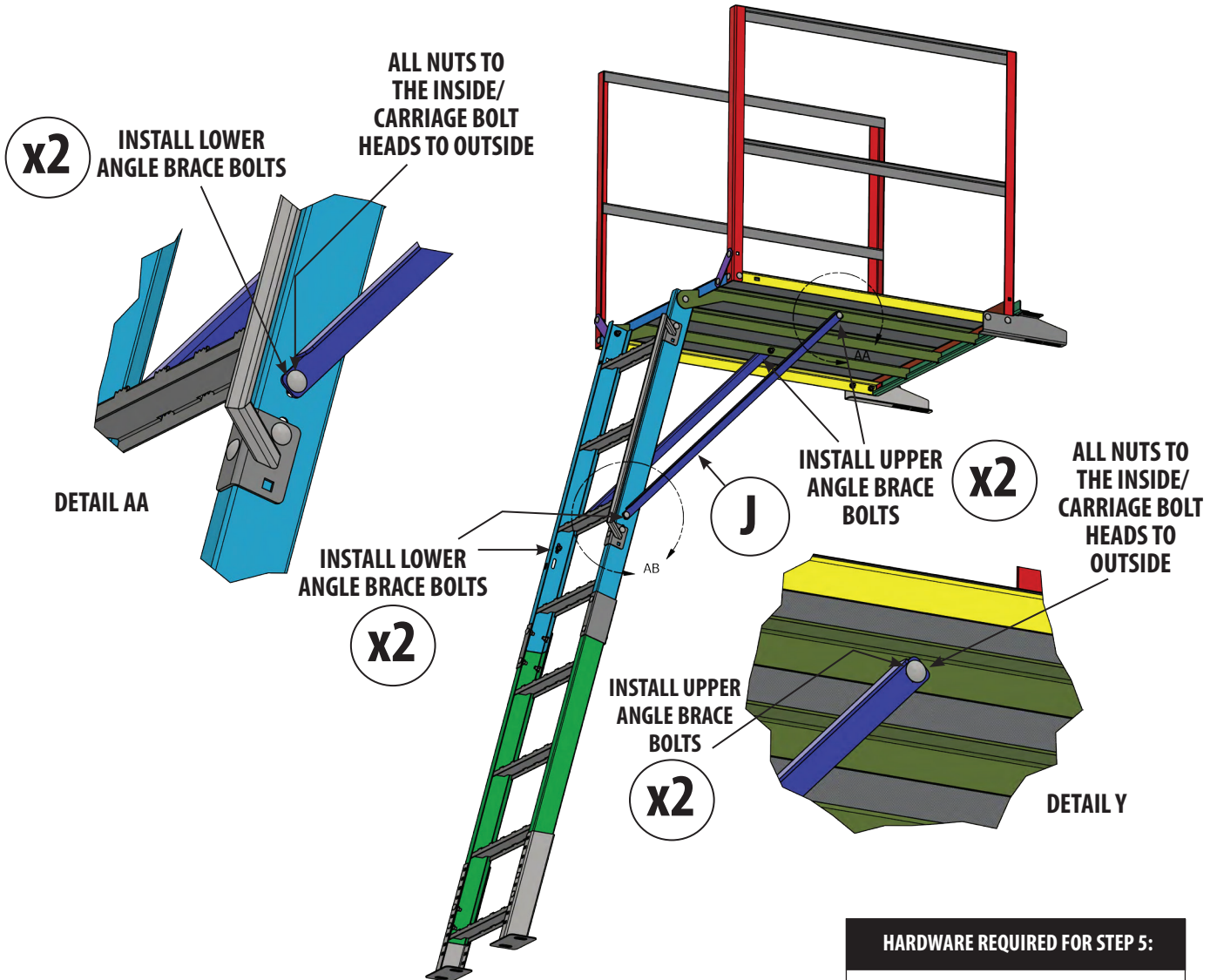

TOOLS REQUIRED FOR ASSEMBLY

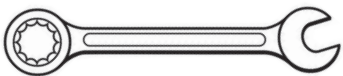

9/16" BOX WRENCH

Make certain the carriage bolts are seated prior to tightening.

Unseated bolts will result in damage to the structural members and bolts. Tighten nuts snugly ensuring they are tight.

DO NOT overtighten nuts as this may damage the hardware.

HARDWARE REQUIRED FOR STEP 5:



3/8"-16 SERRATED FLANGE NUT - QTY: 4
ZINC PLATED STEEL
(NOT TO SCALE)

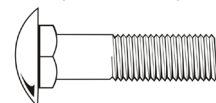

3/8"-16 1" LONG CARRIAGE BOLT - QTY: 4
ZINC PLATED STEEL
(NOT TO SCALE)

Check for parts online at shadowhunterblinds.com or call 888-446-4868 M-F 8-5 CT

PLEASE READ THIS MANUAL IN ITS ENTIRETY PRIOR TO USING THIS PRODUCT!

PLEASE READ THIS MANUAL IN ITS ENTIRETY PRIOR TO USING THIS PRODUCT!



WARNING! Only use approved Summit Outdoors parts included with this Summit Outdoors product. Parts substitution or omission may result in serious injury or death!

PLATFORM INSTALLATION ON USA MADE ELEVATOR STAIR PLATFORM

NOTE: YOUR USA MADE ELEVATOR STAIR PLATFORM CAN ACCOMMODATE FOUR POSSIBLE PLATFORM SIZES ASSEMBLED USING THE SUMMIT OUTDOORS ELEVATOR BRACKET SYSTEM (SOLD SEPARATELY). THESE PLATFORM SIZES INCLUDE: 4' X 6', 5' X 6', 6' X 6' AND 6' X 8'. EACH OF THESE PLATFORMS ATTACH AS OUTLINED BELOW. IT IS OF PARAMOUNT IMPORTANCE YOU FOLLOW THESE ATTACHMENT INSTRUCTIONS WHEN INSTALLING YOUR PLATFORM USING THE INCLUDED HARDWARE.



WARNING! Failure to follow these specific platform installation instructions may result in structural damage to this product, product failure, or may result in serious injury or death!

WHEN ATTACHING THE PLATFORM YOU MUST USE THE SUPPLIED 1/4" X 2 1/2" OUTDOOR LAG SCREWS. DO NOT ATTEMPT TO USE DRY-WALL SCREWS, DECORATIVE SCREWS, BRASS SCREWS, WOOD SCREWS, CLAMPS, RATCHET STRAPS, OR ANY FASTENER OR DEVICE(S) OTHER THAN THOSE INCLUDED WITH THIS SUMMIT OUTDOORS PRODUCT. YOU MUST USE A STEP LADDER TO ATTACH A PLATFORM AND/OR STAIRCASE.

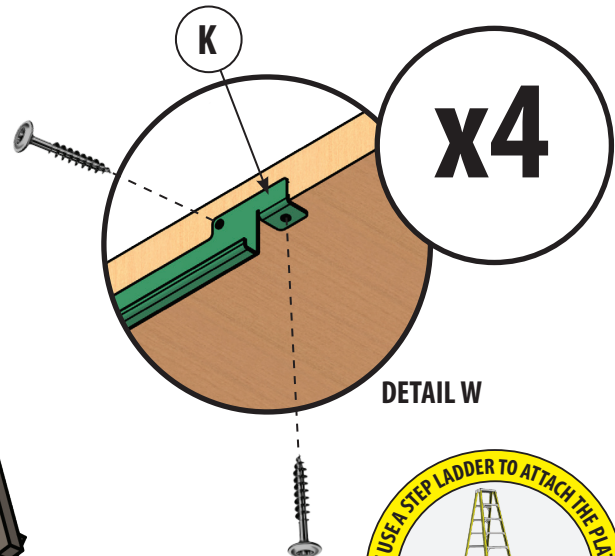
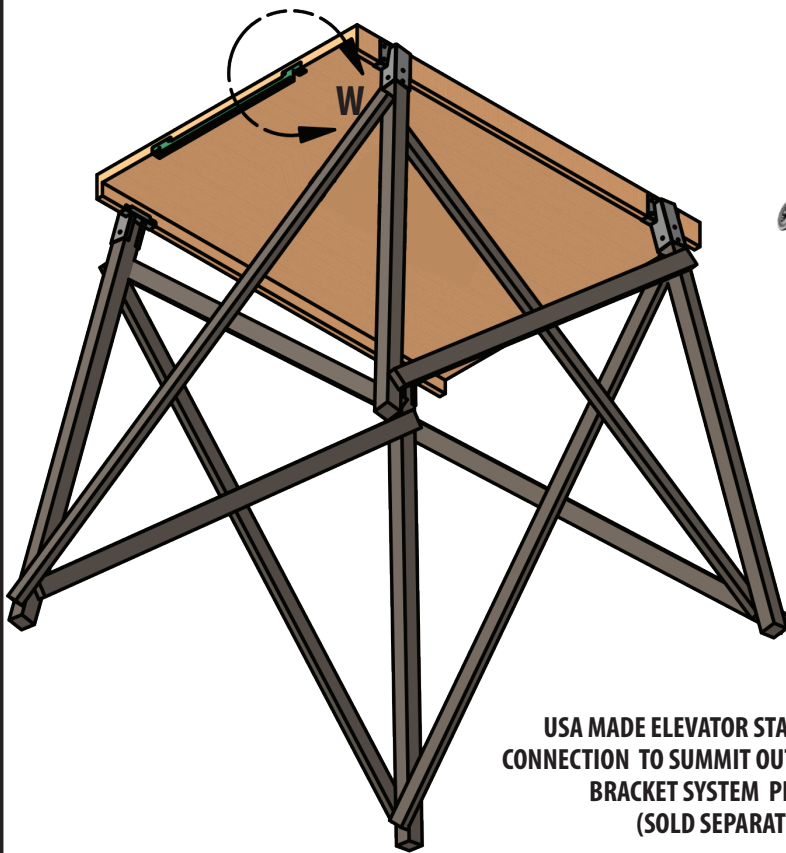

USA MADE ELEVATOR STAIR PLATFORM
CONNECTION TO SUMMIT OUTDOORS ELEVATOR
BRACKET SYSTEM PLATFORM
(SOLD SEPARATELY)

TOOLS REQUIRED FOR ASSEMBLY

WARNING! DO NOT overtighten screws as this may damage the hardware and result in failure. Failure to follow these instructions may result in serious injury or death!

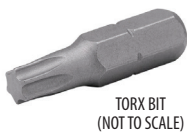

TORX BIT
(NOT TO SCALE)



DRILL DRIVER
(NOT TO SCALE)

STEP LADDER
(NOT TO SCALE)



HARDWARE REQUIRED FOR PLATFORM ATTACHMENT



(4) 1/4" X 2 1/2" OUTDOOR LAG SCREWS w/
TORX HEAD

Check for parts online at shadowhunterblinds.com or call 888-446-4868 M-F 8-5 CT

PLEASE READ THIS MANUAL IN ITS ENTIRETY PRIOR TO USING THIS PRODUCT!

PLEASE READ THIS MANUAL IN ITS ENTIRETY PRIOR TO USING THIS PRODUCT!



WARNING! Only use approved Summit Outdoors parts included with this Summit Outdoors product. Parts substitution or omission may result in serious injury or death!

4' X 6' PLATFORM INSTALLATION ON USA MADE ELEVATOR STAIR PLATFORM

NOTE: YOUR USA MADE ELEVATOR STAIR PLATFORM CAN ACCOMMODATE FOUR POSSIBLE PLATFORM SIZES ASSEMBLED USING THE SUMMIT OUTDOORS ELEVATOR BRACKET SYSTEM (SOLD SEPARATELY). THESE PLATFORM SIZES INCLUDE: 4' X 6', 5' X 6', 6' X 6' AND 6' X 8'. EACH OF THESE PLATFORMS ATTACH AS OUTLINED BELOW. IT IS OF PARAMOUNT IMPORTANCE YOU FOLLOW THESE ATTACHMENT INSTRUCTIONS WHEN INSTALLING YOUR PLATFORM USING THE INCLUDED HARDWARE.



WARNING! Failure to follow these specific platform installation instructions may result in structural damage to this product, product failure, or may result in serious injury or death!

WHEN ATTACHING THE PLATFORM YOU MUST USE THE SUPPLIED 1/4" X 2 1/2" OUTDOOR LAG SCREWS. DO NOT ATTEMPT TO USE DRY-WALL SCREWS, DECORATIVE SCREWS, BRASS SCREWS, WOOD SCREWS, CLAMPS, RATCHET STRAPS, OR ANY FASTENER OR DEVICE(S) OTHER THAN THOSE INCLUDED WITH THIS SUMMIT OUTDOORS PRODUCT. YOU MUST USE A STEP LADDER TO ATTACH PLATFORM AND/OR STAIRCASE.

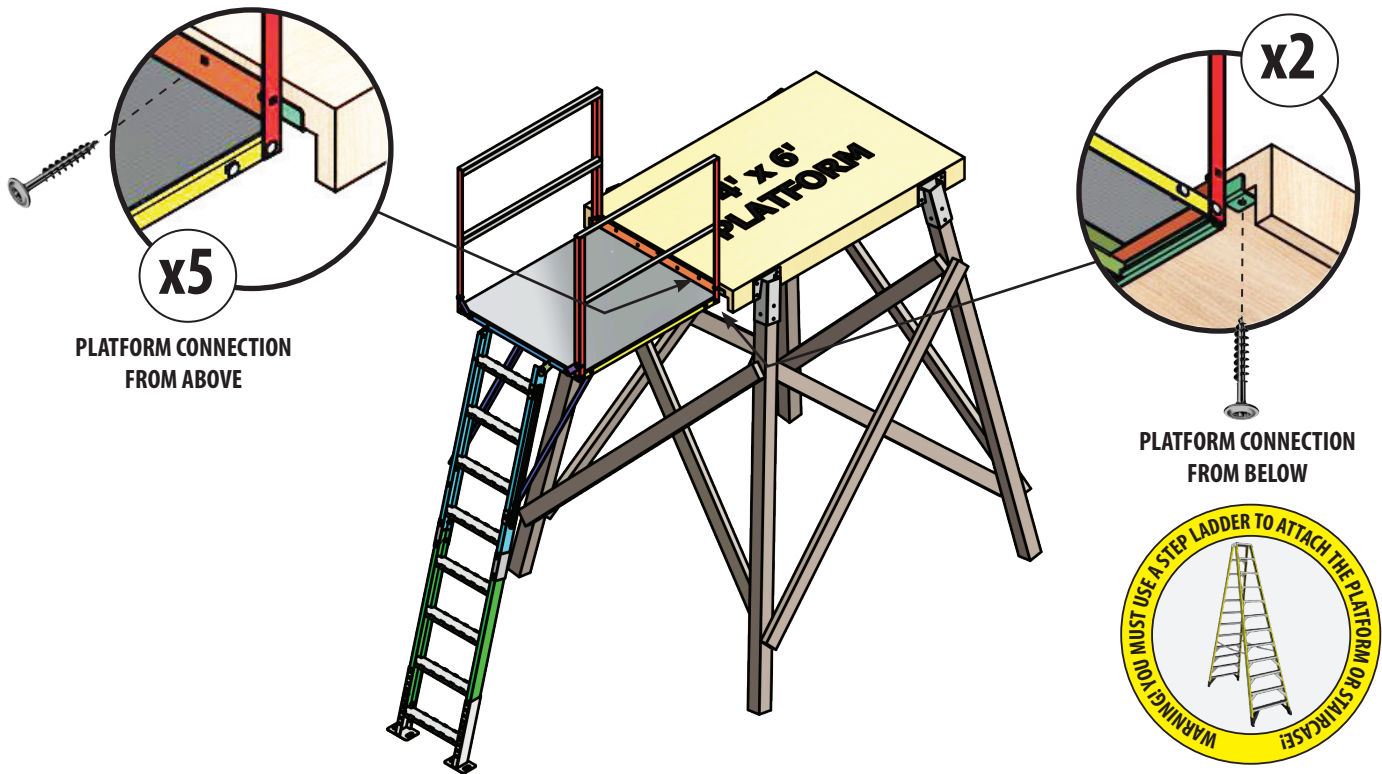

x5
PLATFORM CONNECTION
FROM ABOVE

x2
PLATFORM CONNECTION
FROM BELOW



TOOLS REQUIRED FOR ASSEMBLY

WARNING! DO NOT overtighten screws as this may damage the hardware and result in failure. Failure to follow these instructions may result in serious injury or death!

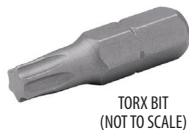

TORX BIT
(NOT TO SCALE)



DRILL DRIVER
(NOT TO SCALE)

STEP LADDER
(NOT TO SCALE)



HARDWARE REQUIRED FOR PLATFORM ATTACHMENT



(7) 1/4" X 2 1/2" OUTDOOR LAG SCREWS w/
TORX HEAD

Check for parts online at shadowhunterblinds.com or call 888-446-4868 M-F 8-5 CT

PLEASE READ THIS MANUAL IN ITS ENTIRETY PRIOR TO USING THIS PRODUCT!

PLEASE READ THIS MANUAL IN ITS ENTIRETY PRIOR TO USING THIS PRODUCT!



WARNING! Only use approved Summit Outdoors parts included with this Summit Outdoors product. Parts substitution or omission may result in serious injury or death!

5' X 6' PLATFORM INSTALLATION ON USA MADE ELEVATOR STAIR PLATFORM

NOTE: YOUR USA MADE ELEVATOR STAIR PLATFORM CAN ACCOMMODATE FOUR POSSIBLE PLATFORM SIZES ASSEMBLED USING THE SUMMIT OUTDOORS ELEVATOR BRACKET SYSTEM (SOLD SEPARATELY). THESE PLATFORM SIZES INCLUDE: 4' X 6', 5' X 6', 6' X 6' AND 6' X 8'. EACH OF THESE PLATFORMS ATTACH AS OUTLINED BELOW. IT IS OF PARAMOUNT IMPORTANCE YOU FOLLOW THESE ATTACHMENT INSTRUCTIONS WHEN INSTALLING YOUR PLATFORM USING THE INCLUDED HARDWARE.



WARNING! Failure to follow these specific platform installation instructions may result in structural damage to this product, product failure, or may result in serious injury or death!

WHEN ATTACHING THE PLATFORM YOU MUST USE THE SUPPLIED 1/4" X 2 1/2" OUTDOOR LAG SCREWS. DO NOT ATTEMPT TO USE DRY-WALL SCREWS, DECORATIVE SCREWS, BRASS SCREWS, WOOD SCREWS, CLAMPS, RATCHET STRAPS, OR ANY FASTENER OR DEVICE(S) OTHER THAN THOSE INCLUDED WITH THIS SUMMIT OUTDOORS PRODUCT. YOU MUST USE A STEP LADDER TO ATTACH PLATFORM AND/OR STAIRCASE.

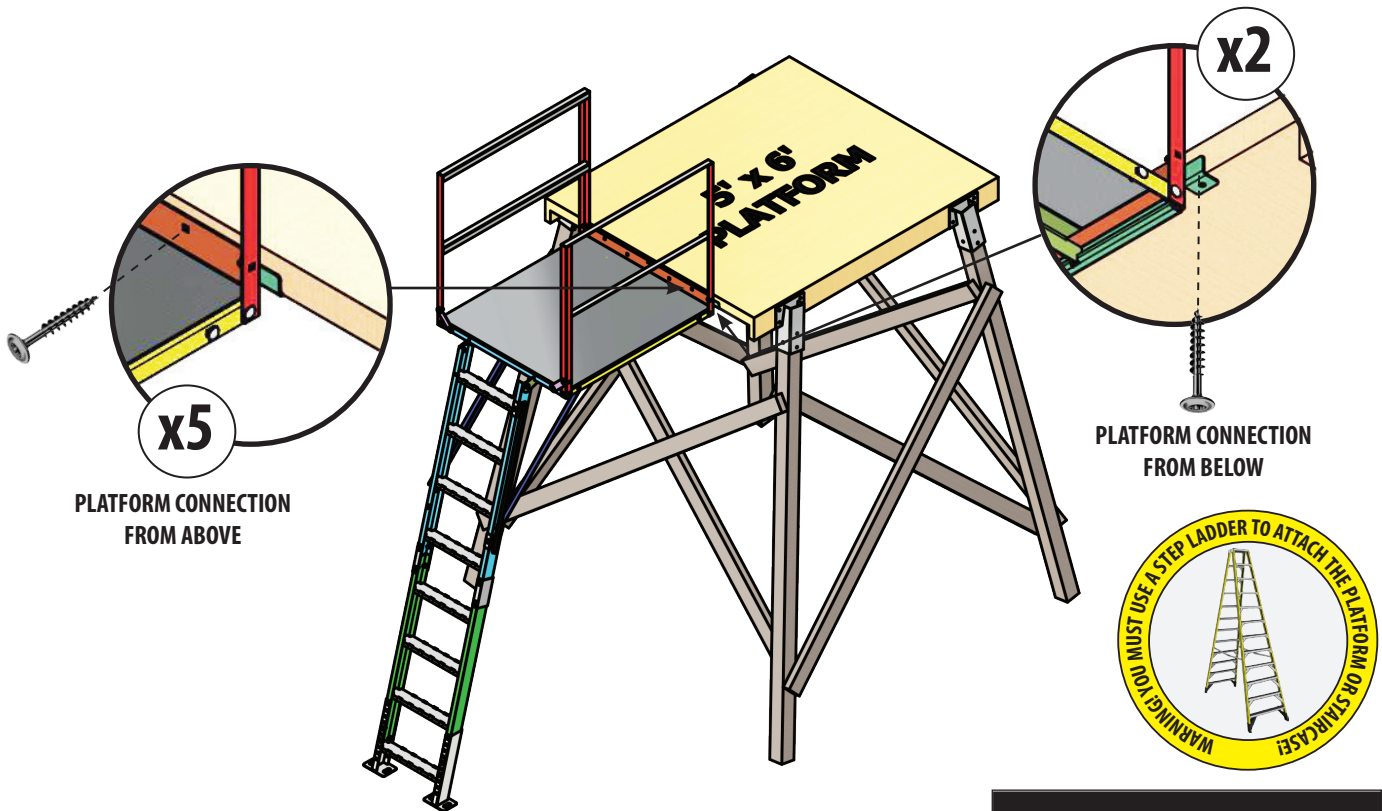

TOOLS REQUIRED FOR ASSEMBLY

WARNING! DO NOT overtighten screws as this may damage the hardware and result in failure. Failure to follow these instructions may result in serious injury or death!

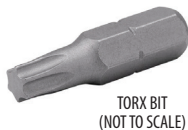

TORX BIT (NOT TO SCALE)



DRILL DRIVER (NOT TO SCALE)

STEP LADDER (NOT TO SCALE)



HARDWARE REQUIRED FOR PLATFORM ATTACHMENT



(7) 1/4" X 2 1/2" OUTDOOR LAG SCREWS w/ TORX HEAD

Check for parts online at shadowhunterblinds.com or call 888-446-4868 M-F 8-5 CT

PLEASE READ THIS MANUAL IN ITS ENTIRETY PRIOR TO USING THIS PRODUCT!

PLEASE READ THIS MANUAL IN ITS ENTIRETY PRIOR TO USING THIS PRODUCT!



WARNING! Only use approved Summit Outdoors parts included with this Summit Outdoors product. Parts substitution or omission may result in serious injury or death!

6' X 6' PLATFORM INSTALLATION ON USA MADE ELEVATOR STAIR PLATFORM

NOTE: YOUR USA MADE ELEVATOR STAIR PLATFORM CAN ACCOMMODATE FOUR POSSIBLE PLATFORM SIZES ASSEMBLED USING THE SUMMIT OUTDOORS ELEVATOR BRACKET SYSTEM (SOLD SEPARATELY). THESE PLATFORM SIZES INCLUDE: 4' X 6', 5' X 6', 6' X 6' AND 6' X 8'. EACH OF THESE PLATFORMS ATTACH AS OUTLINED BELOW. IT IS OF PARAMOUNT IMPORTANCE YOU FOLLOW THESE ATTACHMENT INSTRUCTIONS WHEN INSTALLING YOUR PLATFORM USING THE INCLUDED HARDWARE.



WARNING! Failure to follow these specific platform installation instructions may result in structural damage to this product, product failure, or may result in serious injury or death!

WHEN ATTACHING THE PLATFORM YOU MUST USE THE SUPPLIED 1/4" X 2 1/2" OUTDOOR LAG SCREWS. DO NOT ATTEMPT TO USE DRY-WALL SCREWS, DECORATIVE SCREWS, BRASS SCREWS, WOOD SCREWS, CLAMPS, RATCHET STRAPS, OR ANY FASTENER OR DEVICE(S) OTHER THAN THOSE INCLUDED WITH THIS SUMMIT OUTDOORS PRODUCT. YOU MUST USE A STEP LADDER TO ATTACH PLATFORM AND/OR STAIRCASE.

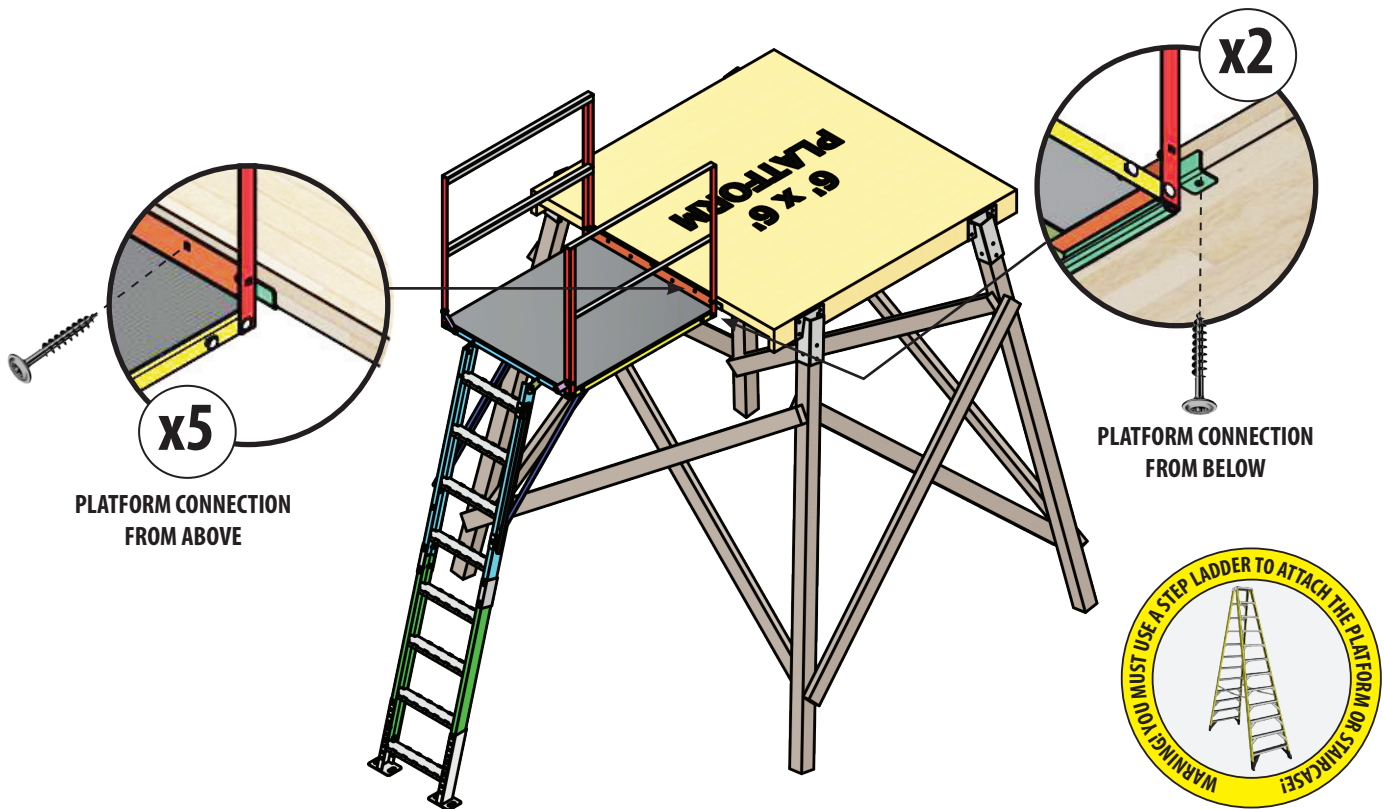

TOOLS REQUIRED FOR ASSEMBLY

WARNING! DO NOT overtighten screws as this may damage the hardware and result in failure. Failure to follow these instructions may result in serious injury or death!

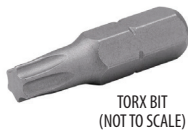

TORX BIT
(NOT TO SCALE)



DRILL DRIVER
(NOT TO SCALE)

STEP LADDER
(NOT TO SCALE)



HARDWARE REQUIRED FOR PLATFORM ATTACHMENT



(7) 1/4" X 2 1/2" OUTDOOR LAG SCREWS w/
TORX HEAD

Check for parts online at shadowhunterblinds.com or call 888-446-4868 M-F 8-5 CT

PLEASE READ THIS MANUAL IN ITS ENTIRETY PRIOR TO USING THIS PRODUCT!

PLEASE READ THIS MANUAL IN ITS ENTIRETY PRIOR TO USING THIS PRODUCT!



WARNING! Only use approved Summit Outdoors parts included with this Summit Outdoors product. Parts substitution or omission may result in serious injury or death!

6' X 8' PLATFORM INSTALLATION ON USA MADE ELEVATOR STAIR PLATFORM

NOTE: YOUR USA MADE ELEVATOR STAIR PLATFORM CAN ACCOMMODATE FOUR POSSIBLE PLATFORM SIZES ASSEMBLED USING THE SUMMIT OUTDOORS ELEVATOR BRACKET SYSTEM (SOLD SEPARATELY). THESE PLATFORM SIZES INCLUDE: 4' X 6', 5' X 6', 6' X 6' AND 6' X 8'. EACH OF THESE PLATFORMS ATTACH AS OUTLINED BELOW. IT IS OF PARAMOUNT IMPORTANCE YOU FOLLOW THESE ATTACHMENT INSTRUCTIONS WHEN INSTALLING YOUR PLATFORM USING THE INCLUDED HARDWARE.



WARNING! Failure to follow these specific platform installation instructions may result in structural damage to this product, product failure, or may result in serious injury or death!

WHEN ATTACHING THE PLATFORM YOU MUST USE THE SUPPLIED 1/4" X 2 1/2" OUTDOOR LAG SCREWS. DO NOT ATTEMPT TO USE DRY-WALL SCREWS, DECORATIVE SCREWS, BRASS SCREWS, WOOD SCREWS, CLAMPS, RATCHET STRAPS, OR ANY FASTENER OR DEVICE(S) OTHER THAN THOSE INCLUDED WITH THIS SUMMIT OUTDOORS PRODUCT. YOU MUST USE A STEP LADDER TO ATTACH PLATFORM AND/OR STAIRCASE.

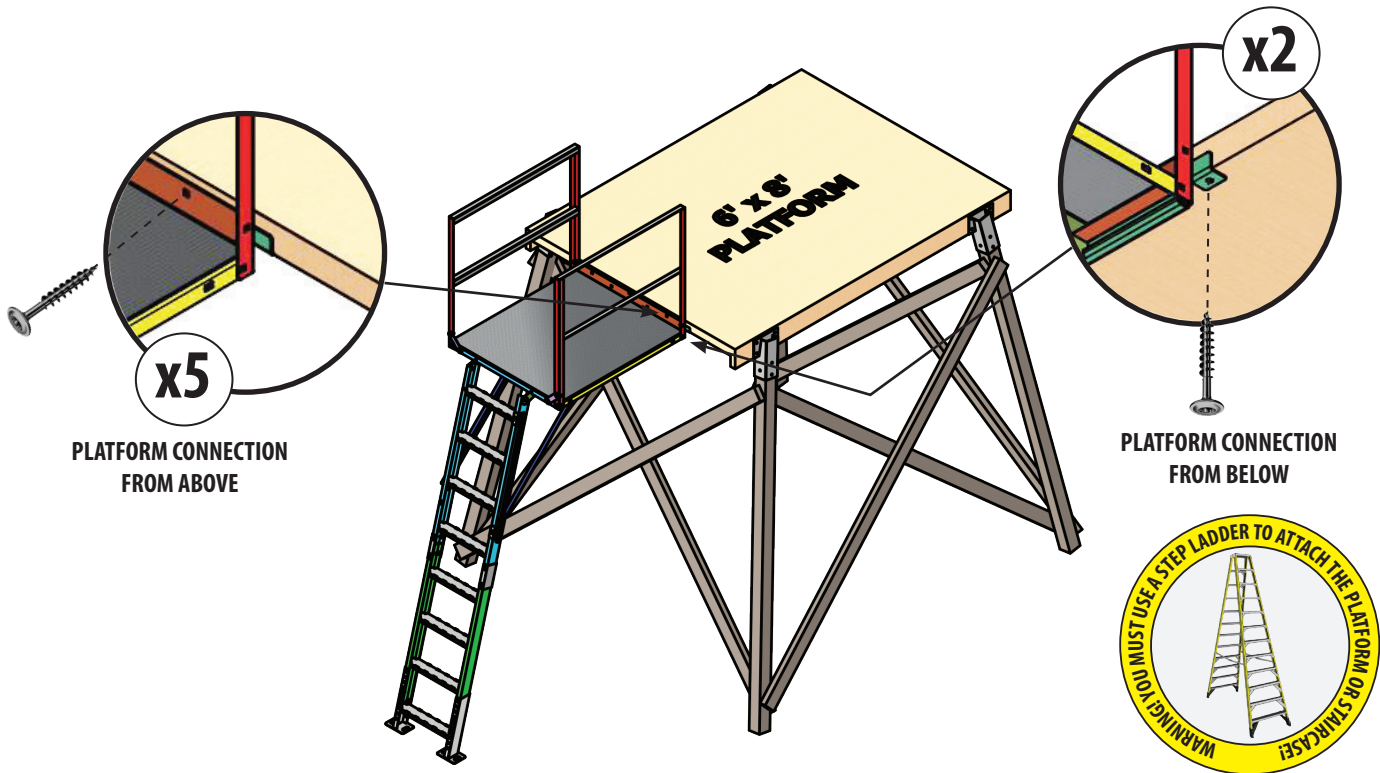

TOOLS REQUIRED FOR ASSEMBLY

WARNING! DO NOT overtighten screws as this may damage the hardware and result in failure. Failure to follow these instructions may result in serious injury or death!

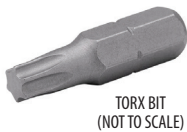

TORX BIT
(NOT TO SCALE)



DRILL DRIVER
(NOT TO SCALE)

STEP LADDER
(NOT TO SCALE)



HARDWARE REQUIRED FOR PLATFORM ATTACHMENT



(7) 1/4" X 2 1/2" OUTDOOR LAG SCREWS w/
TORX HEAD

Check for parts online at shadowhunterblinds.com or call 888-446-4868 M-F 8-5 CT









PLEASE READ THIS MANUAL IN ITS ENTIRETY PRIOR TO USING THIS PRODUCT!

PLEASE READ THIS MANUAL IN ITS ENTIRETY PRIOR TO USING THIS PRODUCT!



ATTENTION!!
**WHEN YOU SEE A "WARNING!" BE SURE TO HEED THE MESSAGE! THE INFORMATION CONTAINED
IN THESE MESSAGES CAN SAVE YOUR LIFE!!**



-  Double check assembly STEPS to be certain you have correctly assembled this product.
-  Study your new stand to become familiar with all of its features and design. You must review these instructions at least annually.
-  Be sure assembly area is open, flat, level, and dry with no power lines near.
-  Always use at least four (4) people to install or take down a free standing platform.
-  Do not use any type of motorized vehicle to upright/assemble this tower. Doing so may cause structural damage to your Summit Outdoors tower/stairs. You must have at least four (4) people to erect this product.
-  Be sure only one person ascends or descends ladder at a time. The entry platform is part of the ladder. Be certain first person is fully off of the ladder/entry platform and positioned safely on tower platform or ground before second person ascends or descends ladder.
-  Always lean forward as you climb ladder/stairs.
-  Always maintain three (3) points of contact when climbing into a free standing platform stand. Proper three-point contact means having either two feet with one hand or one foot with two hands on the step portion of the ladder or climbing aid at all times.
-  Always wear the appropriate footwear when using a free standing platform stand. A good non-slip safety boot is important to your personal safety. Be especially careful that boot laces do not get hooked on the stand or any of its components (tuck shoelaces into boots before climbing).

STORAGE AND CARE

Your new Summit Outdoors product is factory finished with a state-of-the-art powder coating that guarantees years of trouble-free service. It is recommended that you store your Summit Outdoors product out of direct sunlight and out of any other harsh environmental condition(s) that may adversely affect its performance when not in use.

DISCLAIMER OF WARRANTIES; LIMITATION OF LIABILITY

SUMMIT OUTDOORS MAKES NO WARRANTY WHATSOEVER WITH RESPECT TO ITS PRODUCT(S), INCLUDING, ANY WARRANTY OF MERCHANTABILITY, WARRANTY OF FITNESS FOR A PARTICULAR PURPOSE, WARRANTY OF TITLE, OR WARRANTY AGAINST INFRINGEMENT OF INTELLECTUAL PROPERTY RIGHTS OF A THIRD PARTY, WHETHER EXPRESS OR IMPLIED BY LAW, COURSE OF DEALING, COURSE OF PERFORMANCE USAGE OF TRADE, OR OTHERWISE. TO THE FULLEST EXTENT PERMISSIBLE UNDER APPLICABLE LAW, THE PRODUCT(S) ARE PROVIDED TO YOU "AS IS" WITH ALL FAULTS, WITHOUT WARRANTY OF ANY KIND, WITHOUT PERFORMANCE ASSURANCES OR GUARANTEES OF ANY KIND, AND YOUR USE OF THE PRODUCT IS AT YOUR SOLE RISK.

IN NO EVENT SHALL SUMMIT OUTDOORS BE LIABLE UNDER ANY CIRCUMSTANCES TO YOU OR ANY OTHER PARTY FOR ANY SPECIAL, CONSEQUENTIAL, OR INCIDENTAL DAMAGES ARISING OUT OF OR IN ANY WAY CONNECTED WITH THE PRODUCT(S), EVEN IF SUMMIT OUTDOORS OR ANY OF ITS AFFILIATES HAVE BEEN ADVISED OF THE POSSIBILITY OF SUCH DAMAGES. IN NO EVENT SHALL SUMMIT OUTDOORS OR ANY OF ITS AFFILIATES BE LIABLE TO YOU OR ANY OTHER PARTY FOR LOSS, DAMAGE OR INJURY OF ANY KIND.



PLEASE READ THIS MANUAL IN ITS ENTIRETY PRIOR TO USING THIS PRODUCT!

PLEASE READ THIS MANUAL IN ITS ENTIRETY PRIOR TO USING THIS PRODUCT!

PLEASE READ THIS MANUAL IN ITS ENTIRETY PRIOR TO USING THIS PRODUCT!



To register your new Summit Outdoors product(s) please visit us online at
<https://www.shadowhunterblinds.com/pages/product-registration>

SUMMIT OUTDOORS
6714 Pointe Inverness Way
Suite 200
Fort Wayne, Indiana 46804
888-446-4868
shadowhunterblinds.com



Check for parts online at shadowhunterblinds.com or call 888-446-4868 M-F 8-5 CT

17  **SUMMIT**
OUTDOORS 03/24

PLEASE READ THIS MANUAL IN ITS ENTIRETY PRIOR TO USING THIS PRODUCT!

PLEASE READ THIS MANUAL IN ITS ENTIRETY PRIOR TO USING THIS PRODUCT!

PLEASE READ THIS MANUAL IN ITS ENTIRETY PRIOR TO USING THIS PRODUCT!

PLEASE READ THIS MANUAL IN ITS ENTIRETY PRIOR TO USING THIS PRODUCT!



SUMMIT OUTDOORS

SUMMIT OUTDOORS
6714 Pointe Inverness Way
Suite 200
Fort Wayne, Indiana 46804
888-446-4868
shadowhunterblinds.com



Check for parts online at shadowhunterblinds.com or call 888-446-4868 M-F 8-5 CT

18  SUMMIT OUTDOORS 03/24

PLEASE READ THIS MANUAL IN ITS ENTIRETY PRIOR TO USING THIS PRODUCT!