

**SHADOW
HUNTER®**
PROFESSIONAL GRADE HUNTING BLINDS

INSTRUCTION MANUAL

Adjustable Ladder Platform

Model SH33LP

ATTENTION!!

**WHEN YOU SEE A “⚠️ WARNING!” BE SURE TO HEED THE MESSAGE!
THE INFORMATION CONTAINED IN THESE MESSAGES
CAN SAVE YOUR LIFE!!**

PLEASE NOTE THAT ⚠️ WARNING! statements have been placed throughout this Instruction Manual, These statements point out important safety information and instructions, which, if not followed could endanger the personal safety and/or property of the operator. It is imperative that the operator of this product, or any other product(s) read and follow all the instructions and warnings contained in this Manual prior to attempting to use this product(s), or any other product(s). Failure to comply with these instructions and/or warnings may result in serious personal injury or death!

Fort Wayne, IN 46804 • 1-888-446-4868

www.shadowhunterblinds.com

**ATTENTION!! WHEN YOU SEE A "⚠️ WARNING!" BE SURE TO HEED THE MESSAGE!
THE INFORMATION CONTAINED IN THESE MESSAGES CAN SAVE YOUR LIFE!!**

SAFE USAGE INSTRUCTIONS & WARNINGS

SH33LP • ADJUSTABLE LADDER PLATFORM

**CARRYING CAPACITY (USER(S) AND EQUIPMENT) 500LBS (227KG)
ADJUSTABLE FROM 5 FEET TO 10 FEET**

⚠️ WARNING! This product carries strict weight restrictions. Please note that these weight limitations include the user(s) and their equipment. **DO NOT** use these product(s) if you exceed these total weight limitations. Failure to follow these instructions may result in serious injury or death!

Should you have any questions about the installation and/or use of this product, or any other Summit Outdoors, LLC product(s) do not hesitate to call one of our customer service representatives at 888-446-4868 or visit Summit Outdoors, LLC online at www.shadowhunterblinds.com. Our customer service representatives will answer any questions you may have about any of the complete line of Summit Outdoors, LLC products.

Do not return this product to the retailer if you have any damaged or missing parts. Call Summit Outdoors, LLC for replacement of any damaged or missing parts at 888-446-4868.

⚠️ WARNING! Failure to read and strictly comply with the instructions contained in this Instruction Manual may result in serious injury or death!

⚠️ WARNING! FALLS FROM THE ADJUSTABLE LADDER PLATFORM CAN OCCUR ANY TIME AFTER LEAVING THE GROUND. THESE FALLS COULD RESULT IN EITHER SERIOUS INJURY OR DEATH! FOR YOUR PERSONAL SAFETY, PLEASE TAKE A MOMENT TO CAREFULLY READ THIS PRODUCT INSTRUCTION MANUAL IN ITS ENTIRETY BEFORE ATTEMPTING TO ASSEMBLE, SET-UP, INSTALL AND/OR OTHERWISE USE THIS SUMMIT OUTDOORS, LLC PRODUCT. AT LEAST ANNUALLY, REVIEW THE CONTENTS OF THIS INSTRUCTION MANUAL. ADDITIONALLY, KEEP THESE INSTRUCTIONS FOR THE ENTIRE DURATION THAT YOU OWN THIS PRODUCT(S). FAILURE TO FOLLOW THESE INSTRUCTIONS MAY RESULT IN SERIOUS INJURY OR DEATH!

⚠️ WARNING! THE SAFE USE AND OPERATION OF THIS PRODUCT IS THE SOLE RESPONSIBILITY OF THE USER. IT IS ALSO THE SOLE RESPONSIBILITY OF THE OWNER TO PROVIDE ANY PERSON(S) WHO BORROW OR PURCHASE THIS PRODUCT WITH THESE INSTRUCTIONS. FAILURE TO FOLLOW THESE INSTRUCTIONS MAY RESULT IN SERIOUS INJURY OR DEATH! ADDITIONALLY, FAILURE TO FOLLOW THIS INSTRUCTION MAY SUBJECT YOU TO PERSONAL LIABILITY PENALTIES AS DETERMINED BY THE U.S. JUDICIAL SYSTEM.

⚠️ WARNING! Prior to each hunt, you must inform someone of your hunting location, including the specific location of your adjustable ladder platform and the expected duration of your hunt. Failure to follow these instructions may result in serious injury or death!

⚠️ WARNING! Prior to each hunt, make sure that you have a signaling device (e.g., mobile phone, radio, whistle, signal flare or Personal Locator Device (PLD))

in your possession and in an operable condition. This device must be within easy access should you experience the need to contact emergency assistance. Failure to follow these instructions may result in serious injury or death!

⚠️ WARNING! **DO NOT** remove, modify, and/or omit any portion or otherwise mechanically modify this Summit Outdoors, LLC product(s) or its assemblies in any manner. Modification, misuse, and/or part substitution shall immediately void your factory warranty and may result in serious injury or death! If you suspect that a part(s) is missing and/or defective, immediately contact Summit Outdoors, LLC at 888-446-4868 for replacement of missing or defective parts. Never modify your stand in any way by making repairs, or altering, adding or attaching anything to it except if explicitly authorized in writing by Summit Outdoors, LLC. **ALWAYS USE GENUINE FACTORY AUTHORIZED SUMMIT OUTDOORS, LLC REPLACEMENT PARTS. USE OF ANY REPLACEMENT PARTS OTHER THAN GENUINE SUMMIT OUTDOORS, LLC PARTS VOIDS YOUR WARRANTY AND MAY RESULT IN SERIOUS INJURY OR DEATH!**

⚠️ WARNING! This product(s) is designed for adult use only. No one under the age of 16 should attempt to use this or any other Summit Outdoors, LLC product(s) without direct adult supervision. Failure to follow these instructions may result in serious injury or death!

⚠️ WARNING! Never attempt to climb up or down with a weapon and/or gear in your possession. **ALWAYS** unload your weapon and pull it up to hunting height using a tether or pull up rope. **ALWAYS** lower your unloaded weapon down to the ground prior (when raising or lowering firearms, the chamber must be open and the barrel pointing toward the ground) to attempting to climb up or climb down. Use this same method when raising or lowering all other gear. Failure to follow these instructions may result in serious injury or death!

⚠️ WARNING! Prior to each use thoroughly inspect the adjustable ladder platform and all of its related components and all safety devices before use for signs of wear, rot, corrosion, cracks, deterioration and/or any other type of defect. Make certain that your freestanding platform is tight and secure prior to use. Protect this product from extended exposure to direct sunlight, excessive heat or freezing temperatures by storing inside when not in use. **DO NOT** use this or any other product(s) if it shows evidence of wear, rot, corrosion, cracks, deterioration and/or any other type of defect. Failure to follow these instructions may result in serious injury or death!

⚠️ WARNING! **DO NOT** use this or any other Summit Outdoors, LLC product(s) if you have a history of heart problems, back problems, impaired vision, joints that lock-up, spinal fusions, equilibrium problems, high blood pressure, are not well-rested and/or any other physical impairment that may limit your ability to use and/or operate this product(s) in the safe manner outlined in this Instruction Manual. Additionally, do not use this or any other Summit Outdoors, LLC product(s) if you are currently taking medication (including prescription) and/or using and/or consuming any substance, including alcohol, that may limit your ability to use this Summit Outdoors, LLC product(s) as outlined and described in the Instruction Manual. Never use a adjustable ladder platform when feeling ill, nauseous or dizzy. Failure to follow these adjustable ladder platform may result in serious injury or death!

**ATTENTION!! WHEN YOU SEE A “⚠️ WARNING!” BE SURE TO HEED THE MESSAGE!
THE INFORMATION CONTAINED IN THESE MESSAGES CAN SAVE YOUR LIFE!!**

⚠️ WARNING! DO NOT attempt to make adjustments to this product while in the adjustable ladder platform. All adjustments must be made with the entire adjustable ladder platform on the ground. Failure to follow these instructions may result in serious injury or death!

⚠️ WARNING! ALWAYS inspect the adjustable ladder platform and all safety devices prior to each use. **DO NOT** use this product(s) if it shows signs of wear, damage, deterioration, or vandalism. Factors such as tree growth, vandals, weather and animals may affect the performance of an unattended adjustable ladder platform. Failure to follow these instructions may result in serious injury or death!

⚠️ WARNING! DO NOT modify, fix/repair, alter, bend, cut, weld, drill or heat the adjustable ladder platform in any way. Also, do not attach anything to your adjustable ladder platform without explicit authorized and written instructions from the manufacturer. Failure to follow these instructions shall void warranty and may result in serious injury or death!

⚠️ WARNING! Strict weight limitations have been set for each product to ensure your personal safety. Note the weight limitations of your stand and that this weight limit includes the user (one person) and their equipment. **NEVER EXCEED THESE WEIGHT LIMITATIONS!** Failure to follow these instructions may result in serious injury or death!

⚠️ WARNING! DO NOT attempt to use this or any other Summit Outdoors, LLC product(s) when ice, snow, and/or freezing rain has deposited or formed on any portion of the adjustable ladder platform you intend to climb. Do not attempt to use this or any other Summit Outdoors, LLC product(s) when thunderstorms are threatening and/or present within five (5) miles. Do not attempt to use this or any other Summit Outdoors, LLC product(s) when any other adverse weather condition presents itself. These include, but are not limited to, weather conditions which have the potential for producing winds, lightning, rain, snow, sleet and/or any other atmospheric condition which may limit the user's ability to operate this Summit Outdoors, LLC product(s) in a safe manner as described in this Instruction Manual. Should inclement weather conditions arise during your use of this Summit Outdoors, LLC product(s), return to the ground immediately. Failure to follow these instructions may result in serious injury or death!

⚠️ WARNING! DO NOT jump or bounce on the freestanding platform. Failure to follow these instructions may result in serious injury or death!

⚠️ WARNING! BEFORE each use, make sure all nuts and bolts are secure. **CHECK** all hardware and webbing prior to every use to make sure that no damage has occurred to hardware. **DO NOT USE THIS PRODUCT IF ANY DAMAGE IS SUSPECTED.** Failure to follow these instructions may result in serious injury or death!

⚠️ WARNING! REPLACE any damaged or worn part with original parts. Replace attachment straps every one year and when not in use store in a dry, cool, safe place away from sunlight. Never store a adjustable ladder platform or any of its components outdoors when not in use. To purchase parts contact Summit Outdoors, LLC at 888-446-4868. Failure to follow these instructions may result in serious injury or death!

⚠️ WARNING! Always wear the appropriate foot wear when using a adjustable ladderplatform. A good non-slip safety boot is important for your safety. Be especially careful that boot laces do not get hooked on the adjustable ladder platform or its components(tuck shoelaces into boot before climbing). Failure to follow these instructions may result in serious injury or death!

⚠️ WARNING! NEVER hunt out of a adjustable ladder platform at heights at which you are not completely comfortable. Depending upon the hunting conditions, choose the minimum hunting height that allows for safe, effective hunting. Failure to follow these instructions may result in serious injury or death!

⚠️ WARNING! A minimum of three (3) adults is required to install and/or remove a adjustable ladder platform. Failure to follow these instructions may result in serious injury or death!

⚠️ WARNING! Always maintain three-point contact when climbing up or down a adjustable ladder platform. Proper three-point contact means having either two feet with one hand or one foot with two hands on the step portion of the ladder at all times when climbing up or down. Failure to follow these instructions may result in serious injury or death!

⚠️ WARNING! Never attempt to hunt from an unlevel products. Additionally, never attempt to level your adjustable ladder platform at heights above the ground. If you find that your platform is unlevel, canted, angled awkwardly upward or downward, or in any configuration other than level, readjust your adjustable ladderplatform as necessary to alleviate this awkward angle before leaving the ground and climbing into your adjustable ladder platform. Failure to follow these instructions may result in serious injury or death!

⚠️ WARNING! DO NOT erect this product(s) around power generation (transformers, generators, substations, etc.) and/or power transmission equipment (power lines). Failure to follow these instructions may result in serious injury or death!

⚠️ WARNING! Check the ground under your adjustable ladder platform to make it is firm and level. Sloping ground or uneven surfaces can cause your adjustable ladder platform to tilt or shift as you climb. **NEVER** submerge the leg sections in water, place in mud/saturated soil or on any type of loose/soft soil or sand. Do not use this adjustable ladder platform when high winds are present or forecast. Failure to follow these instructions may result in serious injury or death!

⚠️ WARNING! Do not attempt to make adjustments to this product while on the adjustable ladder platform. All adjustments must be made with the entire ladder stand platform on the ground. Failure to follow these instructions may result in serious injury or death!

⚠️ WARNING! Prior to climbing, make sure all legs, ladder or supporting sections are firmly connected and locked. Make certain that none of the sections have come loose or separated. If they are, **DO NOT USE THIS PRODUCT(S).** With the help of three (3) other adults lower the adjustable ladder platform back down to the ground and repair the sections as appropriate. Failure to follow these instructions may result in serious injury or death!

⚠️ WARNING! NEVER use any type of motor vehicle or all-terrain vehicle (ATV) to erect this freestanding platform.

READ THIS MANUAL IN ITS ENTIRETY PRIOR TO USING THIS PRODUCT.







ATTENTION!! WHEN YOU SEE A "⚠ WARNING!" BE SURE TO HEED THE MESSAGE! THE INFORMATION CONTAINED IN THESE MESSAGES CAN SAVE YOUR LIFE!!



SH33LP • PARTS LIST

Part #	Description	Qty
SHP16-0100	Foot Platform	2
SHP22-0101	Center Foot Platform	1
SHP16-0105	Bracket	1
SHP16-0107	Bottom Ladder Section	1
SHP16-0108	Ladder Section	2
SHP16-0113	Top Ladder Step	1
SHP16-0109	Adjuster Leg	2
SHP16-0111	Rear Brace	2
SHP16-0115	Side Post	2
SHP16-0116	Cross Support	2

Part #	Description	Qty
SHP16-0117	Rear Post	2
SHP16-0120	Front Post (R)	1
SHP16-0121	Front Post (L)	1
SHP16-0122	Rail Connector	2
SHP16-0125	Under Support Gusset	2
SHP16-0127	Front Brace	2
SHP16-0000	Support Extension	2
SHP16-0130	Mainframe Support	2
SHP16-0131	Extension Bracket	4
SHP16-0110	Instruction Manual	1

SH33LP • HARDWARE PACK

Part #	Description	Qty
UP16-0020	[A] 1/4" x 1 1/4" Hex Bolt 	2
UP16-0022	[B] 1/4" x 1 1/2" Hex Bolt 	24
UP16-0026	[C] 1/4" x 2" Hex Bolt 	16
UP77-0045	[D] 5/16" x 2 3/4" Hex Bolt 	2
UP16-0040	[E] 1/4" x 3 1/4" Hex Bolt 	10
UP16-0042	[F] 1/4" x 3 1/2" Hex Bolt 	2

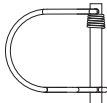
Part #	Description	Qty
UP16-0130	[G] 1/4" x 2 1/2" Carriage Bolt 	5
UP16-0230	[H] 5/16" x 1 1/2" Lag Screw 	4
UP16-0002	1/4" Nylock Nut 	59
UP77-0029	5/16" Nylock Nut 	2
UP16-0004	Nylon Washer 	117
XP87-0036	1/4" x 2" Silent Snap Pin 	8

SH33LP • SPECIFICATION

Max. Weight Capacity (User(s) and Equipment)	Maximum Occupancy	Tools Required for Assembly	Height Range
500 lbs/227kg	TWO (2)	Opened Wrench and Socket, Phillips Head Screwdriver (Not included)	Adjustable From 5' to 10'

It is recommended to make sure you have all parts and hardware prior to assembly.

ATTENTION!! WHEN YOU SEE A "  **WARNING!**" BE SURE TO HEED THE MESSAGE! THE INFORMATION CONTAINED IN THESE MESSAGES CAN SAVE YOUR LIFE!!

⚠ WARNING! Read USAGE INSTRUCTIONS & WARNINGS on pages 2-3 prior to assembly of this product! Failure to follow the instructions on this page and pages 2-3 may result in serious injury or death!

⚠ WARNING! DO NOT over tighten the hardware. Over tightening can lead to structural damage and may negatively affect the performance of your stand. Failure to follow these instructions may result in serious injury or death!

NOTE: All steps require that you temporarily finger tighten all nuts and bolts until instructed to tighten. This will ensure proper alignment during assembly.

FIGURE 1 (SH33LP)



STEP 1. Bolt the two **Foot Platforms** and **Center Foot Platform** together using six (6) **1/4" × 2" Hex Bolts [C]**, twelve (12) **Nylon Washers** and six (6) **1/4" Nylon Nuts**.

FIGURE 2 (SH33LP)

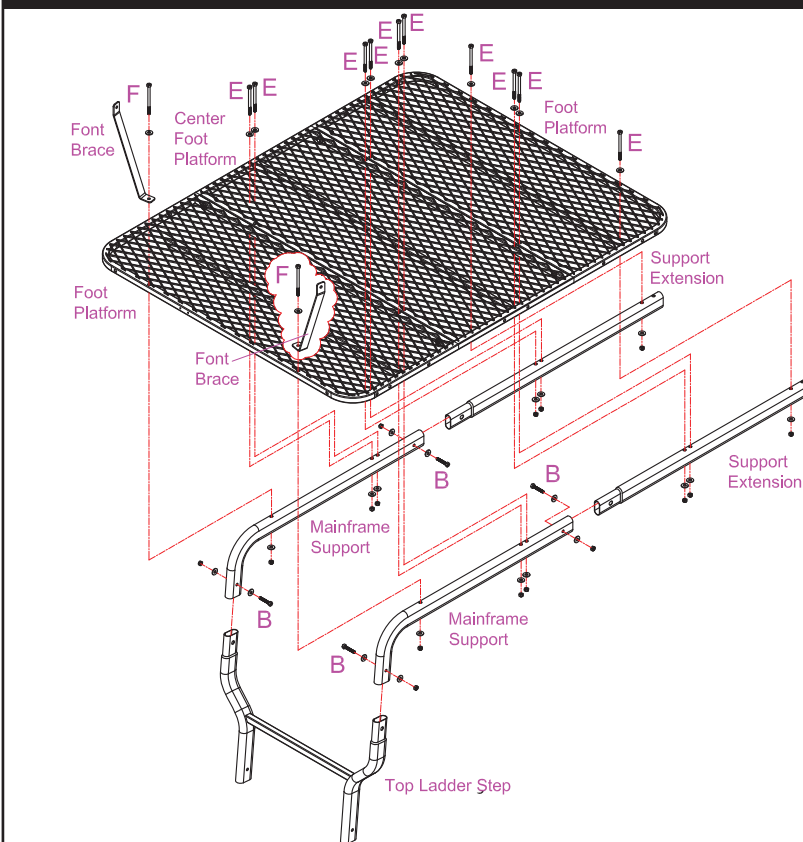

STEP 2. Attach the **Mainframe Supports** to the **Top Ladder Step** using two (2) **1/4" × 1 1/2" Hex Bolts [B]**, four (4) **Nylon Washers** and two (2) **1/4" Nylock Nuts**. Then Attach the **Support Extensions** to the **Mainframe Supports** using two (2) **1/4" × 1 1/2" Hex Bolts [B]**, four (4) **Nylon Washers** and two (2) **1/4" Nylock Nuts**.

STEP 3. Using two (2) **1/4" × 3 1/2" Hex Bolts [F]**, four (4) **Nylon Washers** and two (2) **1/4" Nylock Nuts**, attach the **Front Braces** to the **Foot Platform** and **Mainframe Supports**.
Note: the **Front Braces** should be angled outward.

STEP 4. Using ten (10) **1/4" × 3 1/4" Hex Bolts [E]**, twenty (20) **Nylon Washers** and ten (10) **1/4" Nylock Nuts**, attach the **Platform** and assembled **Mainframe Supports**.

READ THIS MANUAL IN ITS ENTIRETY PRIOR TO USING THIS PRODUCT.

ATTENTION!! WHEN YOU SEE A “  WARNING!” BE SURE TO HEED THE MESSAGE! THE INFORMATION CONTAINED IN THESE MESSAGES CAN SAVE YOUR LIFE!!

FIGURE 3 (SH33LP)

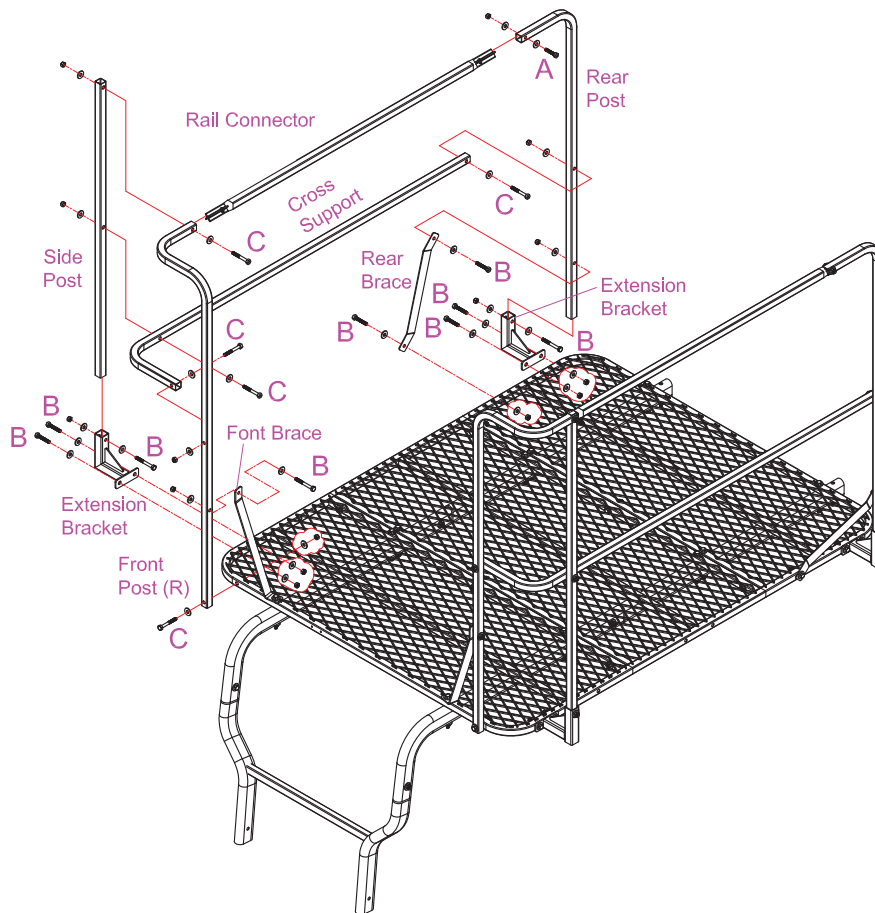

STEP 5. Connect the **Extension Brackets** to the **Foot Platform** (rear) using two (2) 1/4"× 1 1/2" **Hex Bolts** [B], four (4) **Nylon Washers** and two (2) 1/4" **Nylock Nuts**. Then insert the **Rear Post** to the **Extension Bracket**, Bolt them using one (1) 1/4"× 1 1/2" **Hex Bolt** [B], two (2) **Nylon Washers** and one (1) 1/4" **Nylock Nut**.

STEP 6. Attach the **Rear Brace** to the **Platform** and **Rear Post** using two (2) 1/4"× 1 1/2" **Hex Bolts** [B], four (4) **Nylon Washers** and two (2) 1/4" **Nylock Nuts**.

STEP 7. Then bolt the **Front Post (R)** to the **Platform** using one (1) 1/4" × 2" **Hex Bolt** [C], two (2) **Nylon Washers** and one (1) 1/4" **Nylock Nut**. Next, connect the other end of **Front Brace** to the **Front Post (R)** using one (1) 1/4"× 1 1/2" **Hex Bolt** [B], two (2) **Nylon Washers** and one (2) 1/4" **Nylock Nut**.

STEP 8. Insert one **Rail Connector** to the **Rear Post** and **Front Post (R)**. Bolt it to **Rear Post** using one (1) 1/4"× 1 1/4" **Hex Bolt** [A], two (2) **Nylon Washers** and one (1) 1/4" **Nylock Nut**.

STEP 9. Connect the **Extension Bracket** to the **Foot Platform** (front) using two (2) 1/4"× 1 1/2" **Hex Bolts** [B], four (4) **Nylon Washers** and two (2) 1/4" **Nylock Nuts**. Next insert the **Side Post** to the **Extension Bracket**, Bolt them using one (1) 1/4"× 1 1/2" **Hex Bolt** [B], two (2) **Nylon Washers** and one (1) 1/4" **Nylock Nut**. Then bolt the front of the **Rail Connector** and **Front Post** to the **Side Post** using one (1) 1/4"× 2" **Hex Bolt** [C], two (2) **Nylon Washers** and one (1) 1/4" **Nylock Nut**.

STEP 10. Next, bolt the **Cross Support** to **Rear Post**, **Side Post** and **Front Post(R)** using three (3) 1/4"× 2" **Hex Bolts** [C], six (6) **Nylon Washers** and three (3) 1/4" **Nylock Nuts**.

REPEAT STEP 5. - STEP10. ON OTHER SIDE.

STEP 11. SECURELY TIGHTEN EVERY NUT AND BOLT AT THIS TIME.

ATTENTION!! WHEN YOU SEE A "⚠ WARNING!" BE SURE TO HEED THE MESSAGE! THE INFORMATION CONTAINED IN THESE MESSAGES CAN SAVE YOUR LIFE!!

FIGURE 4 (SH33LP) From 8 Feet to 10 Feet Max

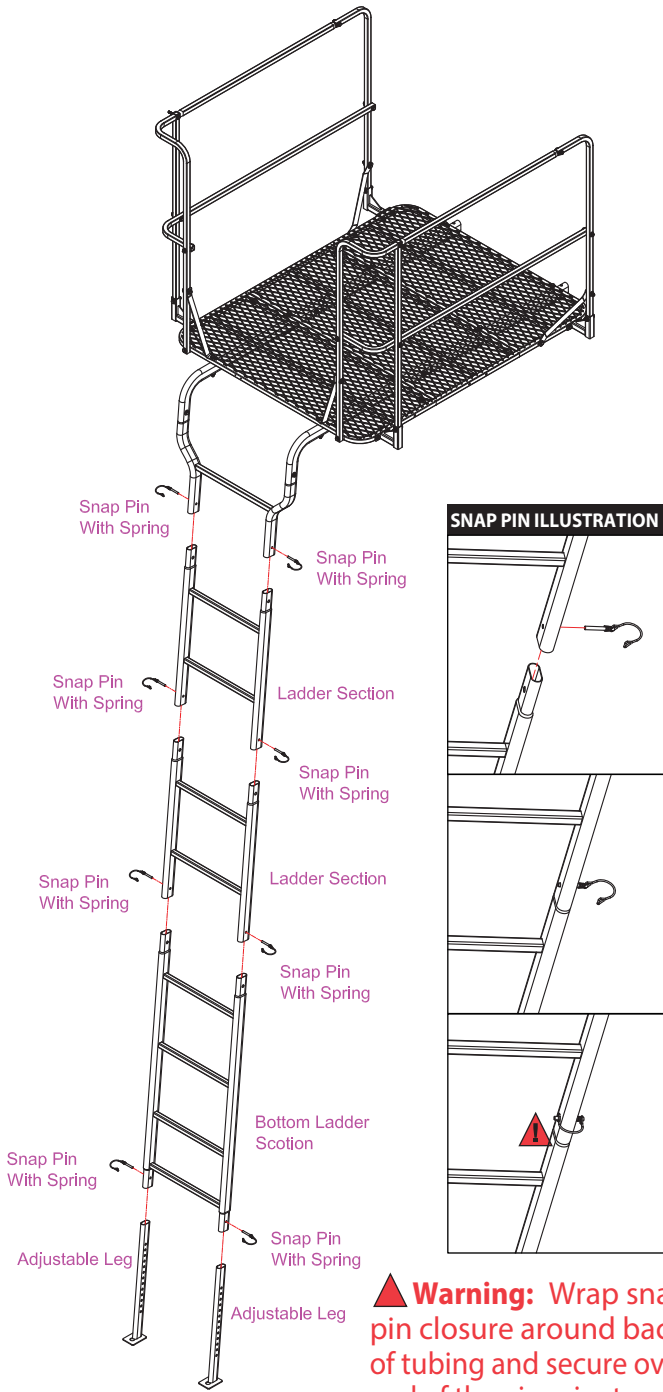

STEP 12. Now you assemble the Ladder Section into the **Top Ladder Step**. Depending on the height of your **Blind Structure** you can use a combination of 3 choices. **A: Adjuster Legs/Bottom Ladder Section.** **B: Adjuster Legs/ Bottom Ladder Section/ one Ladder Section .** **C: Adjuster Legs/ Bottom Ladder Section/ two Ladder Sections .**

FIGURE 4A (SH33LP) From 6 Feet to 8 Feet

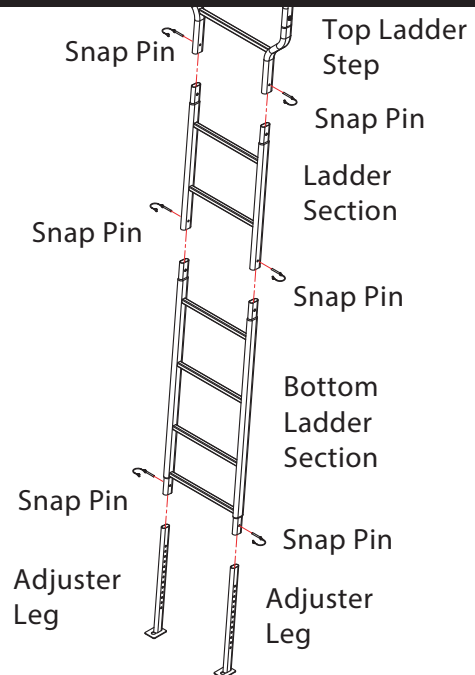
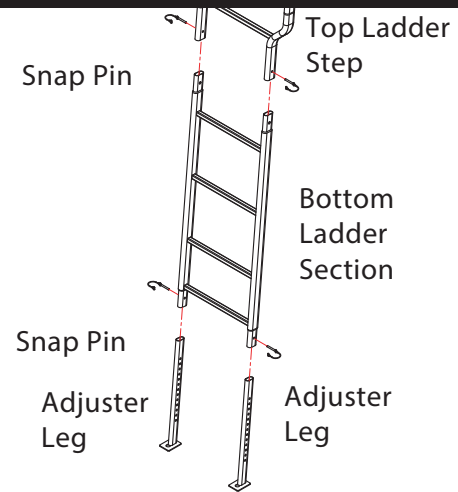

FIGURE 4B (SH33LP) For 6 Feet or Less



Your choice between A, B, & C depends on your blind height and should be chosen accordingly. Adjuster Legs have multiple holes for added adjustment. Ensure the Platform is level when full connected to the blind and at full height before using the ladder. Use two (2) Snap Pins to secure each Ladder Section that is used together, and two (2) Snap Pins to secure the Adjuster Legs (FIGURE 4, FIGURE 4A, FIGURE 4B).

READ THIS MANUAL IN ITS ENTIRETY PRIOR TO USING THIS PRODUCT.

ATTENTION!! WHEN YOU SEE A "⚠ WARNING!" BE SURE TO HEED THE MESSAGE! THE INFORMATION CONTAINED IN THESE MESSAGES CAN SAVE YOUR LIFE!!

FIGURE 5 (SH33LP)

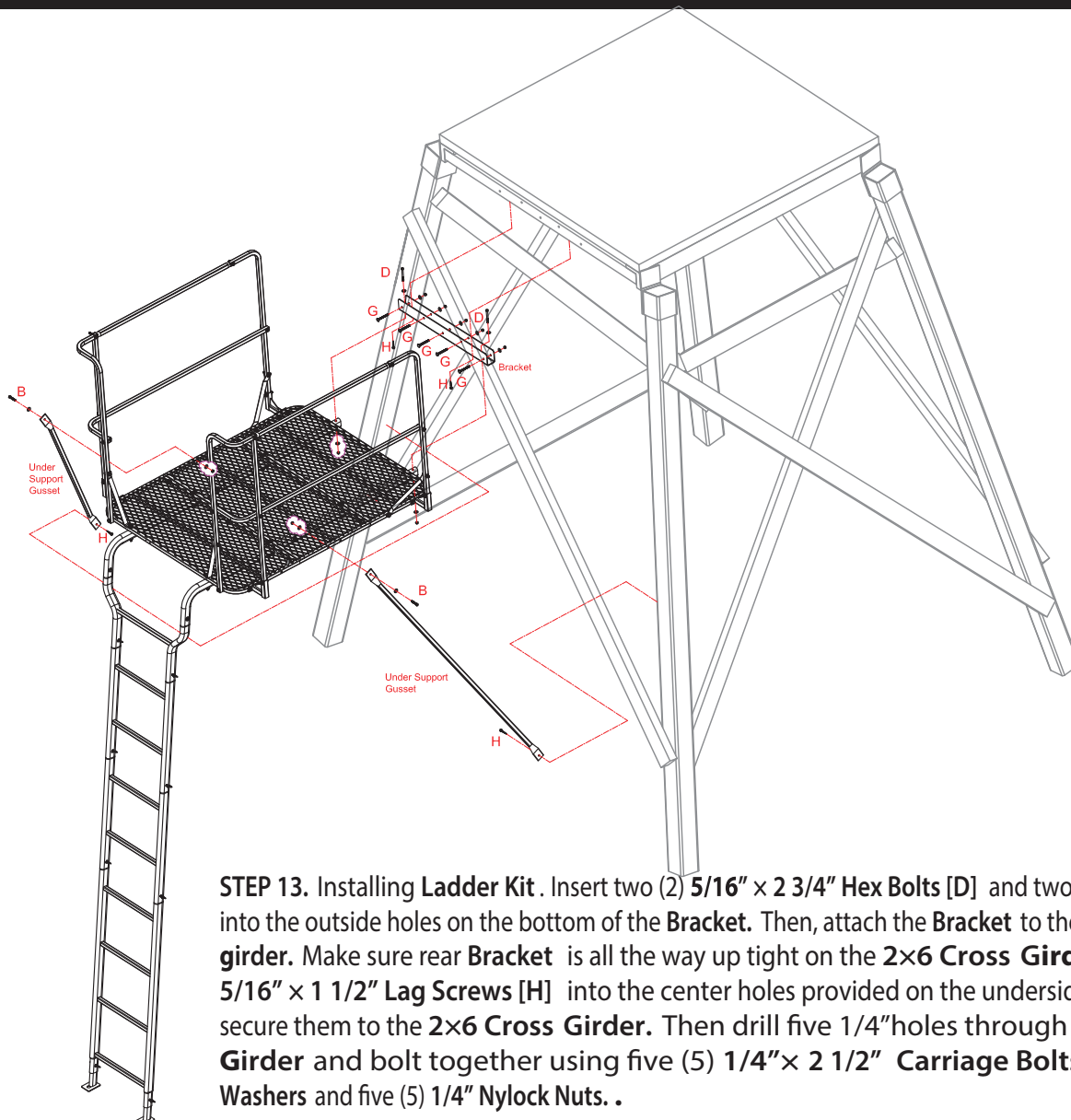

STEP 13. Installing **Ladder Kit** . Insert two (2) **5/16" × 2 3/4" Hex Bolts [D]** and two (2) **Nylon Washers** into the outside holes on the bottom of the **Bracket**. Then, attach the **Bracket** to the **2×6 Cross girder**. Make sure rear **Bracket** is all the way up tight on the **2×6 Cross Girder**. Screw two (2) **5/16" × 1 1/2" Lag Screws [H]** into the center holes provided on the underside of the **Bracket** to secure them to the **2×6 Cross Girder**. Then drill five 1/4"holes through the **2×6 Cross Girder** and bolt together using five (5) **1/4"× 2 1/2" Carriage Bolts[G]**, five (5) **Nylon Washers** and five (5) **1/4" Nylock Nuts** .

STEP 14. With three people raise your **Platform Kit** to the bottom of your **Shadow Hunter Blind** or **Platform**. Attach the **Mainframe Support** to the **Shadow Hunter Blind** using two (2) pre-assembled two (2) **5/16" × 2 3/4" Hex Bolts [D]**, two (2) **Nylon Washers** and two (2) **5/16" Nylock Nuts**. **DO NOT CLIMB UP LADDER KIT WHILE MOUNTING TO BLIND**. Use a step ladder to drill and bolt in place.

STEP 15. Adjust both bottom **Adjuster Legs** so they are firmly on the ground and supporting the weight of the **Platform Kit** equally.

STEP 16. Bolt the two **Under Support Gussets** to the **Center Foot Platform** using two (2) **1/4"× 1 1/2" Hex Bolts [B]**, four (4) **Nylon Washers** and two (2) **1/4" Nylock Nuts**.

Then using two (2) **5/16" × 1 1/2" Lag Screws [H]** screw the **Under Support Gussets** to the center of the **4×4 Post** that your blind is sitting on.

STEP 17. SECURELY TIGHTEN EVERY NUT AND BOLT AT THIS TIME.

**ATTENTION!! WHEN YOU SEE A "⚠ WARNING!" BE SURE TO HEED THE MESSAGE!
THE INFORMATION CONTAINED IN THESE MESSAGES CAN SAVE YOUR LIFE!!**

PRODUCT REGISTRATION INFORMATION



**To activate your product's warranty,
please mail in your registration card or submit it online at
www.shadowhunterblinds.com.
or fax to 260-483-2070**

Product Purchased: _____ Model Number: _____

Serial Number: _____

Owner's Name: _____

Street Address: _____

City: _____ State: _____ Zip Code: _____

E-mail Address: _____ Phone: _____

Date Purchased: _____

Purchased From (Dealer Name): _____

How did you hear about us: ___Catalog ___ Webpage ___ Friend ___ Magazine

Other, Please Explain: _____

Are you a: ___ Bow Hunter ___ Gun Hunter ___ Both

Summit Outdoors, LLC | Fort Wayne, IN 46804

PLEASE FILL OUT REGISTRATION CARD TO ACTIVATE YOUR PRODUCT'S WARRANTY.

**ATTENTION!! WHEN YOU SEE A "⚠ WARNING!" BE SURE TO HEED THE MESSAGE!
THE INFORMATION CONTAINED IN THESE MESSAGES CAN SAVE YOUR LIFE!!**

STANDARD LIMITED WARRANTY

Warranty: Summit Outdoors, LLC. warrants all adjustable ladder platform products to be free from defects in material and workmanship for a period of twelve months from the original date of retail purchase. Summit Outdoors, LLC warrants the enclosed hardware (where applicable) is delivered to be free from physical defects for a period of twelve months from the original date of retail purchase.

Repair Procedures, Exclusive Remedy: Summit Outdoors, LLC will at its option, repair, or replace products not conforming to this limited warranty at no charge. THIS IS THE SOLE AND EXCLUSIVE REMEDY AVAILABLE FOR BREACH OF WARRANTY OR UNDER ANY OTHER LEGAL THEORY WITH RESPECT TO SUMMIT OUTDOORS, LLC PRODUCTS. If you find a product to be defective, contact the customer service department at 1-888-446-4868. When you receive authorization, return the product as directed at your expense. Product repairs not covered by warranty, and product updates, will be provided at a set rate.

Limitations: This warranty is void if the product is damaged by improper or abnormal use or by accident; if the product is altered or modified in any way other than those directed by official Summit Outdoors, LLC or if any attempt is made to repair the product without authorization from Summit Outdoors, LLC. It is solely the purchaser's responsibility to determine the suitability of these products for each particular application. Summit Outdoors, LLC products are intended for hunting and hunting only. Summit Outdoors, LLC products are in all events not suitable, and are not authorized, for use in any situations that might pose potentially injurious to life and health, other than those situations that the products are intended for. This warranty is not assignable or transferable.

No Other Warranties: EXCEPT AS PROVIDED IN THIS LIMITED WARRANTY SET FORTH IN THE WARRANTY CARD SUPPLIED WITH SUMMIT OUTDOORS, LLC AND INSTRUCTION SHEETS ARE PROVIDED "AS IS". ALL OTHER WARRANTIES AND REPRESENTATIONS, ORAL OR WRITTEN, EXPRESSED OR IMPLIED, INCLUDING BUT NOT LIMITED TO ANY IMPLIED WARRANTIES OF MERCHANTABILITY OR FITNESS FOR A PARTICULAR PURPOSE, ARE EXCLUDED AND DO NOT APPLY. THERE ARE NO WARRANTIES WHICH EXTEND BEYOND THE DESCRIPTION ON THE FACE HERE OF. Except as required by law, no representative, agent or employee of Summit Outdoors, LLC is authorized to make warranties, representations, or obligations inconsistent with or in addition to those set forth in this limited warranty.

No Damages: In no event will Summit Outdoors, LLC be liable for direct, indirect, special, incidental, or consequential damages resulting from breach of warranty or under any other legal theory, even if advised of the possibility of such damages. In no event will Summit Outdoors, LLC be liable for sums in excess of the purchase price of the product. Summit Outdoors, LLC is thus not liable for lost profits or goodwill; downtime; damage or destruction of items or equipment used with, or in conjunction with, Summit Outdoors, LLC; personal injury or loss; or any other damages.

General: (a) This agreement is the entire agreement between you and Summit Outdoors, LLC; supersedes any prior or different agreements, representations, or proposals; and may be changed only by written agreement with Summit Outdoors, LLC (b) Waiver by any party of any default or breach of this agreement will not constitute a waiver of any subsequent default or breach of the same or different kind. (c) The invalidity of any provision of this agreement shall not affect the validity of the other provisions hereof. (d) This agreement shall be governed by the laws of the State of Indiana, U.S.A.. Summit Outdoors, LLC 6714 Pointe Inverness Way, Suite 200. Fort Wayne, IN 46809.

**ATTENTION!! WHEN YOU SEE A “⚠ WARNING!” BE SURE TO HEED THE MESSAGE!
THE INFORMATION CONTAINED IN THESE MESSAGES CAN SAVE YOUR LIFE!!**

NOTES

READ THIS MANUAL IN ITS ENTIRETY PRIOR TO USING THIS PRODUCT.

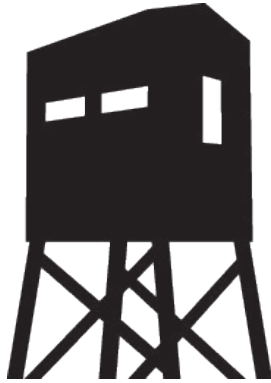

SHADOW HUNTER®

PROFESSIONAL GRADE HUNTING BLINDS

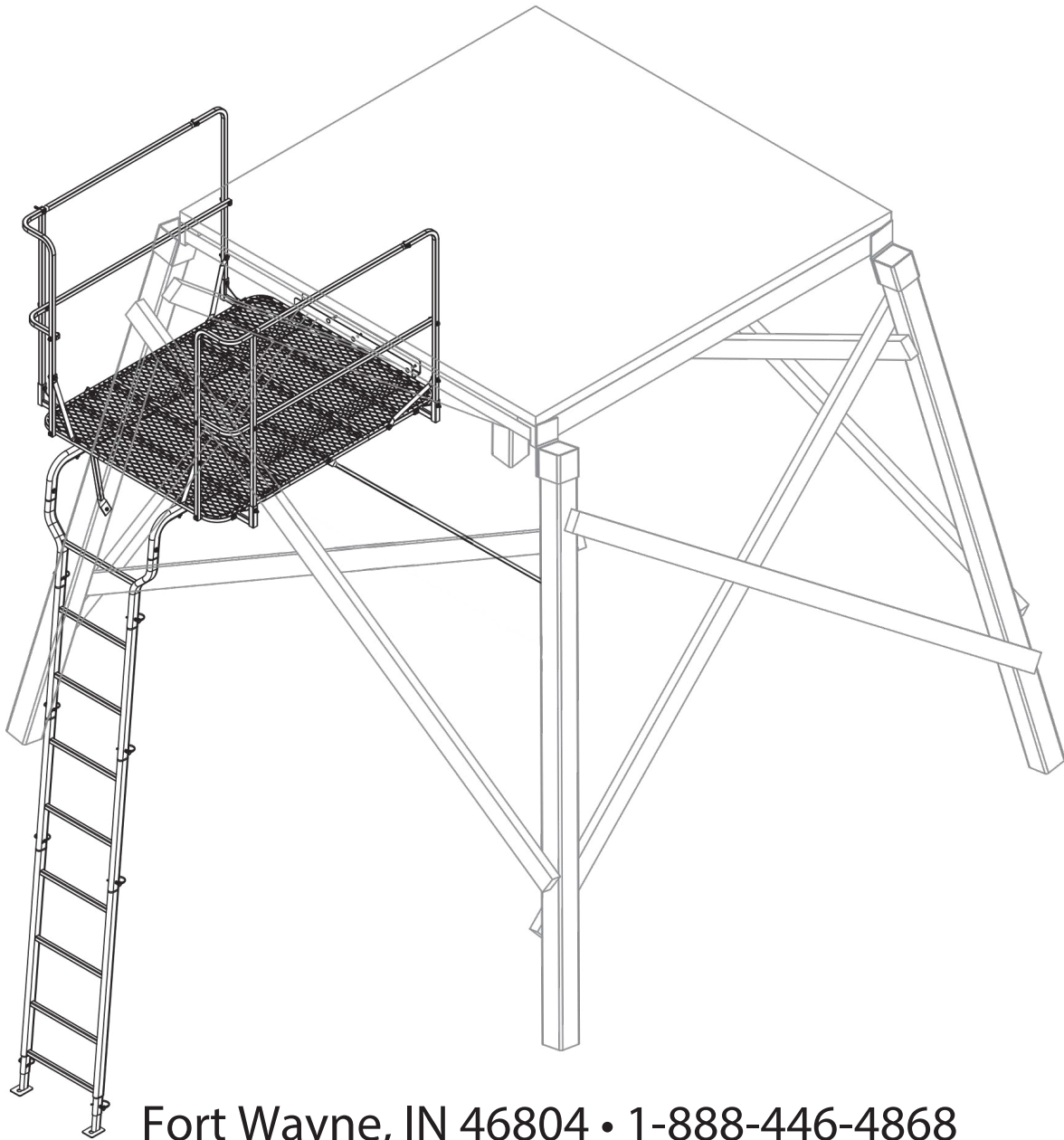

Fort Wayne, IN 46804 • 1-888-446-4868

www.shadowhunterblinds.com

Fifth Edition, Nov 2021. Published by Summit Outdoors, LLC, Fort Wayne Indiana.
© 2017 Summit Outdoors, LLC All right reserved.