

Gona

Coffee Table

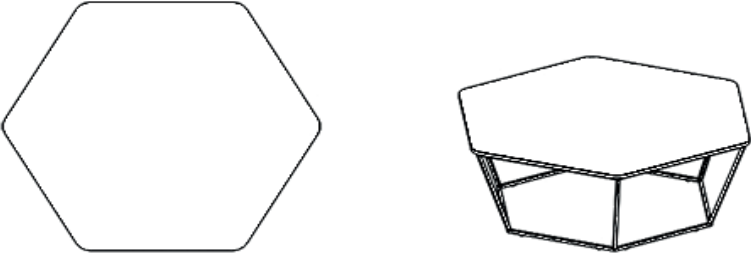
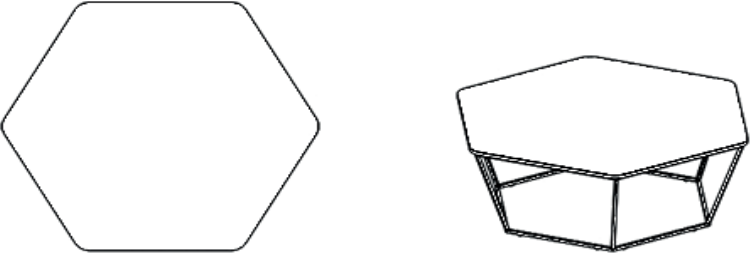

You can either create a decorative stance by forming a honeycomb with putting a few Gona Coffee Tables or bring the functionality forward by using the tables separately!

Technical Drawing

					
<p>SHP016 GONA</p> <p>AHŞAP / LAKE WOOD / LACQUER</p>			<p>SHP516 GONA</p> <p>CAM / SERAMİK / MERMER GLASS / CERAMIC / MARBLE</p>		
E: 93 cm	D: 82 cm	Y: 34 cm	E: 95 cm	D: 83 cm	Y: 33 cm
L: 36,6 inch	D: 32,3 inch	H: 13,4 inch	L: 37,4 inch	D: 32,7 inch	H: 13,0 inch

Technical Information

Top Finishes

SHP516

4 mm Perlaglass and Sahara Noir

Perlaglass tempered glass and Shara Noir are 1st class durable glass materials which are resistant to physical impacts with semi-precious stone look.

12 mm Ceramic;

It is the 1st class durable ceramic material which is laminated with ceramic glass and has a marble look.

20 mm Savana Gray semi-precious stone;

It is a 100% natural semi-precious stone material used in the upper table of the coffee table and adds a vivid and luxurious appearance to the product with its veiny patterns.

SHP016

Natural wood and lacquer options

Lacquer painted material on laminated particle boards or medium-density fiberboards (MDF) are used in the tables of the coffee tables.

Legs

Legs of the coffee table are made of 10x10mm sheet iron material. It is painted with powder paint and then oven-dried in 210°C degrees. Legs of the table are goffrato painted which has a grainy structure.

Top Finishes

SHP016

Wood and Lacquer Options

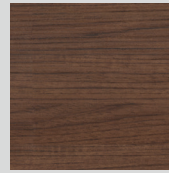

Walnut

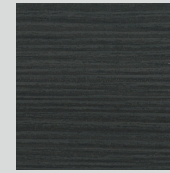

Smoke

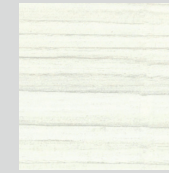

Maple

All Lacquer Options

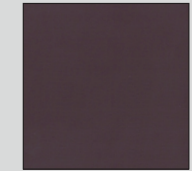
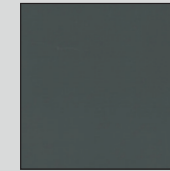
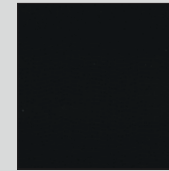
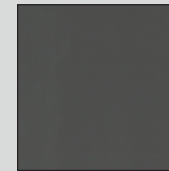
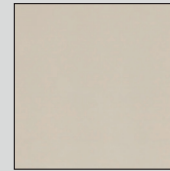
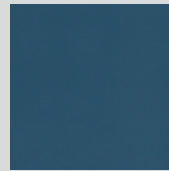

SHP516

Glass, Ceramic and Marble



Sandro

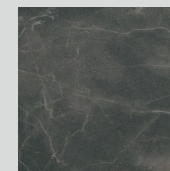

Perla

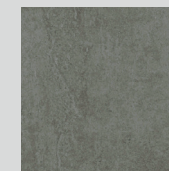

Mica Grey

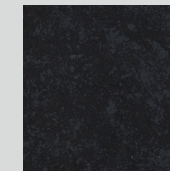

Mica Blue

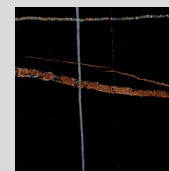

Sahara
Noir

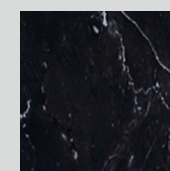

Perlaglass

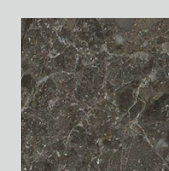

Savana
Grey

Legs

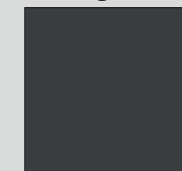

Goffrato