

Beta 25 SD

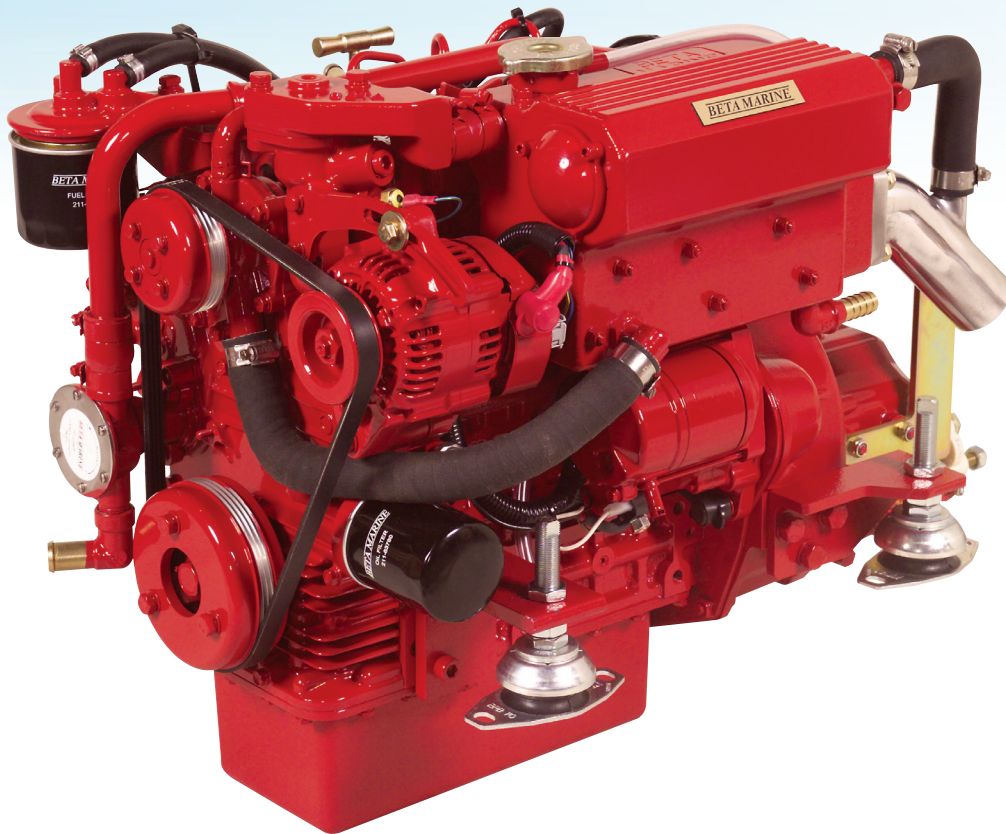

BETA MARINE

5

ANNI DI GARANZIA
'SELF-SERVICE'

Solo per puro uso Diporto

BETA MARINE





2

ANNI DI GARANZIA
SAILDRIVE

Solo per puro uso Diporto

L'immagine del motore con Invertitore è a puro scopo illustrativo

**Su base
Kubota**

	Cilindri	3
	Cilindrata	898cc
	Potenza	25hp max @ 3,600rpm
	Peso	113Kg
	Elica	N.B.*

Possiamo fornire un'indicazione per elica a 3 Pale RH basata su specifiche standard e riduzione 2:1.

*N.B. Per calcoli personalizzati sono necessari tutti i dati dell'imbarcazione.

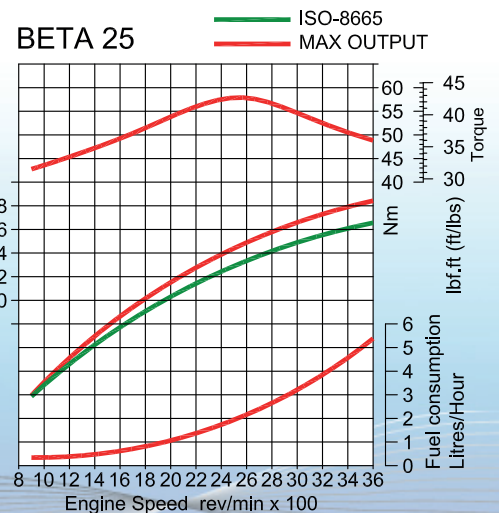

Basata sul carico teorico dell'elica a massimo regime



Opzioni Pannelli di Controllo

Tipo "A"	Opt.	Tipo "B"	Opt.
Tipo "ABV"	Std.	Tipo "BW" stagno	Opt.
Tipo "ABVW" stagno	Opt.	Tipo "C" Deluxe	Opt.
		Tipo "CW" Deluxe stagno	Opt.



Opzioni Saildrive

SeaProp 60 Saildrive Leg	Std.
--------------------------	------



Kit Accoppiamento

Volvo		Bukh	
110S Saildrive	Std.	Bukh Saildrive	Std.
120S Saildrive	Std.	Yanmar	
130S Saildrive	Std.	SD20 Saildrive	Std.



Opzioni Alternatori

Alternatore 40 Amp, 12 Volt	Std.	Alternatore 70 Amp, 12 Volt al posto dello std	Opt.
		Separatore di carica 125 Amp, 12 Volt	Opt.



Dimensioni con Saildrive SeaProp 60

	A	B	C	D	E	F	Peso
Beta 25 SD	218	217	484	663	340	421	133Kg

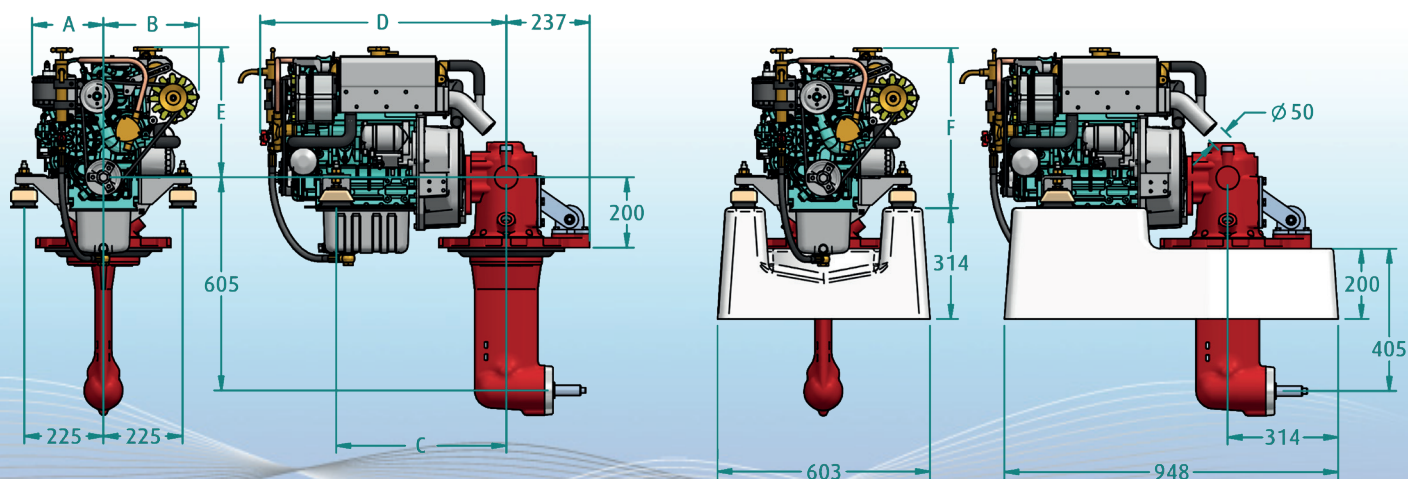

Queste dimensioni sono accurate, i disegni ad uso illustrativo: visitate il sito internet o contattate il Rivenditore per informazioni dettagliate