



**PYLONTECH**



**Lithium-Ion Phosphate  
Battery  
Pelio-L-5.12  
Operation Manual**

Information Version: 5PMPA08-00124

**SD22PE51010701**

Before operation, please check the PACKAGE LIST CARD carefully.

If there are any missing content, please contact the after-sales department in time for treatment.

It is recommended to connect to the Pylontech Cloud service. Operation refer to [chapter 4 ] or manual of WIFI block.

This manual introduces Pelio from Pylontech. Pelio-L-5.12 is a Lithium-Ion Phosphate Battery Storage System. Please read this manual before you install the battery and follow the instruction carefully during the installation process. Any confusion, please contact Pylontech immediately for advice and clarification

<b>1. Safety</b> .....	<b>1</b>
1.1 Symbol.....	1
1.2 EU Declaration of Conformity.....	3
1.3 Safety Precautions.....	3
1.4 Before Connecting.....	4
1.5 In Using.....	5
<b>2. Introduction</b> .....	<b>6</b>
2.1 Features.....	7
2.2 Specification.....	8
2.3 Equipment interface instruction.....	10
<b>3. Safe handling of lithium batteries guide</b> .....	<b>15</b>
3.1 Schematic diagram of solution.....	15
3.2 Danger remind.....	15
3.3 Tools.....	16
3.4 Safety Gear.....	16
<b>4. Installation and Operation</b> .....	<b>18</b>
4.1 Package items—refer to package check list for detailed information.....	18
4.2 System Working Environments Checking.....	22
4.2.1 Cleaning.....	22

4.2.2	Ventilation.....	22
4.2.3	Fire-extinguisher System.....	23
4.2.4	Grounding System.....	23
4.2.5	Clearance.....	23
4.3	Preparation Before Installation.....	24
4.3.1	Operating Precautions.....	24
4.3.2	Plan the Installation Site.....	25
4.3.3	Unboxing the Package.....	25
4.4	Wall and Ground Mounting.....	26
4.4.1	Wall Mounting.....	26
4.4.2	Ground Mounting.....	30
4.5	Power Connection.....	34
4.6	Make Communication Connection.....	36
4.7	Make Grounding Connection.....	39
4.8	Enclosure Installing.....	40
4.9	Power on.....	41
4.10	Power off.....	44
4.11	Guide of USB.....	45
4.12	User Manual of WiFi module.....	45
4.13	Multi-group mode.....	46
<b>5</b>	<b>Trouble shooting.....</b>	<b>50</b>
<b>6</b>	<b>Remarks.....</b>	<b>56</b>

## 1. Safety

Read all safety instructions carefully prior to any work and observe them at all times when working on with the system.





### Incorrect operation or work may cause:











- Injury or death to the operator or a third party;
- Damage to the system hardware and other properties belonging to the operator or a third party.

### Skills of Qualified Personnel:

- Training in the installation and commissioning of the electrical system, as well as the dealing with hazards.
- Knowledge of this manual and other related documents.
- Knowledge of the local regulations and directives.

#### 1.1 Symbol

	Danger!
	Caution! Reminding. Safety related information. Risk of battery system failure or life cycle reduces.
	Do not reverse connection the positive and negative.
	Do not place near open flame

	<p>Do not place at the children and pet touchable area.</p>
	<p>Warning electric shock.</p>
	<p>Warning Fire. Do not place near flammable material</p>
	<p>Read the product and operation manual before operating the battery system!</p>
	<p>Grounding.</p>
	<p>Recycle label.</p>
	<p>The certificate label for EMC.</p>
	<p>The certificate label for UKCA.</p>
	<p>Label for Waste Electrical and Electronic Equipment (WEEE) Directive (2012/19/EU)</p>
	<p>The certificate label for Safety by TÜV Rheinland.</p>

## 1.2 EU Declaration of Conformity

within the scope of the EU directives

- Radio Equipment Directive 2014/53/EU (22.5.2014 L 153/62) (RED)
- Restriction of the use of certain hazardous substances 2011/65/EU (L 174/88, June 8,2011) and 2015/863/EU (L 137/10, March 31,2015) (RoHS)
- Waste electrical and electronic equipment 2012/19/EU (L 197/38, 24.7.2012) (WEEE)

Pylon Technologies Co., Ltd. confirms herewith that the products described in this document are in compliance with the fundamental requirements and other relevant provisions of the above mentioned directives.

## 1.3 Safety Precautions



### Reminding

- 1) It is important and necessary to read the user manual carefully before installing or using battery. Failure to do so or to follow any of the instructions or warnings in this document can result in electrical shock, serious injury, or death, or can damage battery, potentially rendering it inoperable

- 2) If the battery is stored for long time, it is required to charge them every six months, and the SOC should be no less than 70%
- 3) Battery needs to be recharged within 12 hours, after fully discharged
- 4) Do not expose cable outside
- 5) Do not connect power terminal reversely.
- 6) All the battery power terminals must be disconnected for maintenance
- 7) Please contact the supplier within 24 hours if there is something abnormal.
- 8) Do not use cleaning solvents to clean battery
- 9) Do not expose battery to flammable or harsh chemicals or vapors
- 10) Do not connect battery with PV solar wiring directly
- 11) The warranty claims are excluded for direct or indirect damage due to items above.
- 12) Any foreign object is prohibited to insert into any part of battery

#### 1.4 Before Connecting



##### **Warning**

- 1) After unpacking, please check product and packing list first, if product is damaged or lack of parts, please contact with the local retailer
- 2) Before installation, be sure to cut off the grid power and make sure the battery is in the turned-off mode
- 3) Wiring must be correct, do not mistake the positive and negative cables, and ensure no short circuit with the



external device

- 4) It is prohibited to connect the battery and AC power directly
- 5) The embedded BMS in the battery is designed for 51.2VDC, please DO NOT connect battery in series
- 6) Battery must connect to ground and the resistance must be less than  $0.1\Omega$
- 7) Please ensured the electrical parameters of battery system are compatible to related equipment
- 8) Keep the battery away from water and fire.

### **1.5 In Using**

- 1) If the battery system needs to be moved or repaired, the power must be cut off and the battery is completely shutdown
- 2) It is prohibited to connect the battery with different type of battery.
- 3) It is prohibited to connect batteries with faulty or incompatible inverter
- 4) It is prohibited to disassemble the battery (QC tab removed or damaged);
- 5) In case of fire, dry powder fire extinguisher or vast amount of water can be used.
- 6) Please do not open, repair or disassemble the battery except staffs from Pylontech or authorized by Pylontech. We do not undertake any consequences or related responsibility which because of violation of safety operation or violating of design, production and equipment safety standards
- 7) Do not connect parallel with US or UP series from Pylontech.

## 2. Introduction

Pelio-L-5.12 is the brand new 51.2V DC energy storage system developed by Pylontech, it can be used to support reliable power for residence and is the good partner for environmental life.

## 2.1 Features

- 1) NEW: Support 24h online monitor with WIFI connection.
- 2) NEW: Support service and upgrade via USB interface.
- 3) High power output.
- 4) Build-in soft-start function able to reduce current strike when inverter need to start from battery.
- 5) Dual active protection on BMS level.
- 6) Support upgrade battery module from upper controller via CAN or RS485 communication.
- 7) Enable 95% depth of discharge, available for the inverter which completely follow Pylontech latest protocol to operate.
- 8) The module is non-toxic, non-pollution and environmentally friendly
- 9) Cathode material is made from LiFePO<sub>4</sub> with safety performance and long cycle life
- 10) Battery management system (BMS) has protection functions including over-discharge, over-charge, over-current and high/low temperature
- 11) The system can automatically manage charge and discharge state and balance voltage of each cell
- 12) Flexible configuration, multiple battery modules can be in parallel for expanding capacity and power
- 13) Adopted self-cooling mode rapidly reduced system entire noise
- 14) The module has less self-discharge, up to 6 months without charging it on shelf, no memory effect, excellent performance of shallow charge and discharge

## 2.2 Specification

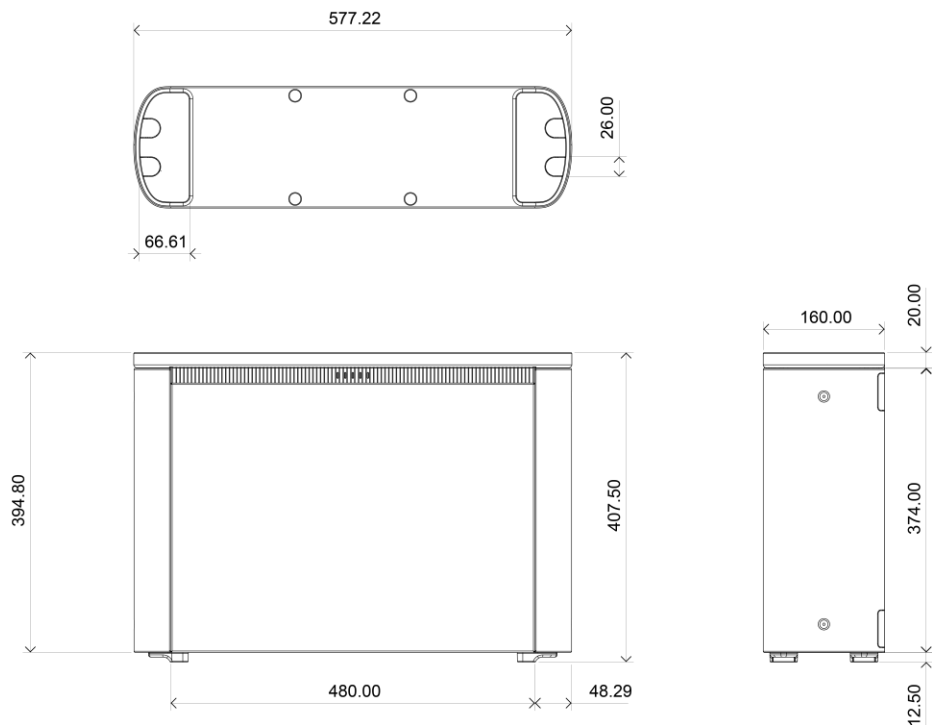

Basic Parameters	Pelio-L-5.12
Nominal Voltage (V)	51.2
Nominal Capacity (Wh)	5120
Usable Capacity (Wh)	4864
Dimension (mm)	395*578*165
Weight (Kg)	45
Discharge Voltage (V)	44.8 ~ 56.8
Charge Voltage (V)	56.0 ~ 56.8
Recommend Charge/Discharge Current (A)	80

Max. Charge/Discharge Current (A)	100~120@15min
<b>Basic Parameters</b>	<b>Pelio-L-5.12</b>
Peak Charge/Discharge Current (A)	120~200@15sec
Communication	RS485, CAN
Operation&Connection	WIFI (2.4G), USB 2.0
Depth of discharge (%)	95
Configuration (max. in 1 battery group)	20pcs
Working Temperature	0°C~50°C Charge
	-10°C~50°C Discharge
Shelf Temperature	0°C~40°C (6 months)
	-20°C~45°C (3 months)
Short current/duration time	<4000A/2ms
Cooling type	Natural
Protective class	I
IP rating of enclosure	IP65
Humidity	5% ~ 95%(RH) No Condensation
Altitude(m)	<4000
Design life	15+ Years (25°C/77°F)
Cycle Life	>6,000 25°C
Reference to standards	IEC62619, IEC63056, IEC62040, IEC62477-1, UL1973,U1642,UL9540A, VDE2510-50, IEC61000-6- 2, IEC61000-6-3, UN38.3

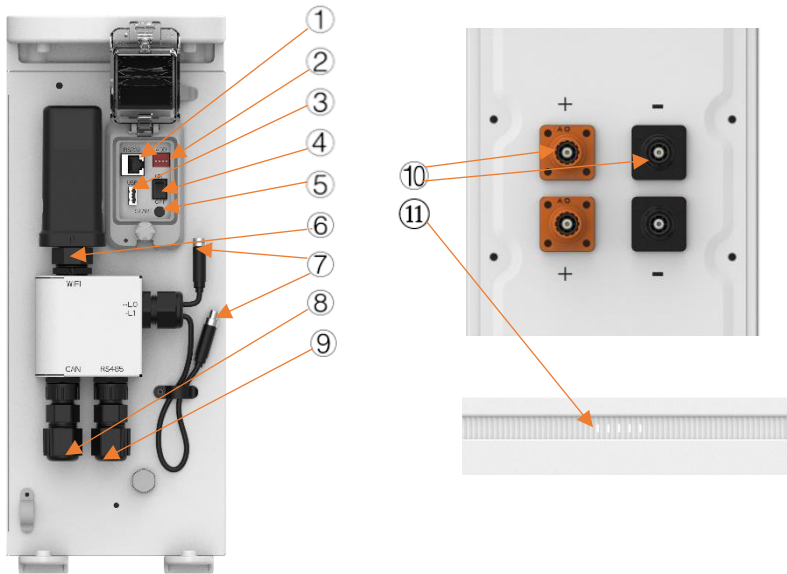

## 2.3 Equipment interface instruction

Operation window: **If not in use, you must close and lock the cover.**

### 1) Console

For manufacturer or professional engineer to debug or service.

Pin3	232-TX
Pin6	232-RX
Pin8	232-GND

### 2) ADD Switch

Dip1: RS485 baud rate

0	1
---	---

	
115200	9600

After change, please restart battery.

Dip2~4: Reserved

### 3) USB port

For manufacturer or professional engineer to debug or service. USB2.0.

### 4) Power Switch

ON: ready to turn on.

OFF: power off. For storage or shipping.

### 5) Start

Turn on: press more than 3s to start the battery module.

Turn off: press more than 3s to turn off the battery.

### 6) WIFI port

Connect the WIFI block from Pylontech ONLY.

**Do not connect any other USB device.**

**If not using, MUST lock the cover**

### 7) Link Port 0, 1

For communication between multiple parallel batteries.

### 8) CAN

500 Kbps. For connection to inverter

**If not using, MUST lock the cover**

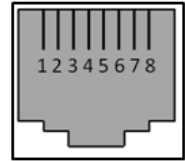

RJ45 Port

### 9) RS485

9600 or 115200 bps. For connection to inverter

**If not using, MUST lock the cover**

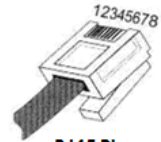

RJ45 Plug

	CAN	RS485
Pin4	CAN-H	
Pin5	CAH-L	
Pin6	GND	
Pin7		485A
Pin8		485B

### 10) Power Terminals

Power cable terminals: there are two pair of terminals with same function.

For power cables uses water-proofed connectors. must keep pressing the Lock Button while pulling out the power plug.

### 11) LED Status Indicators

LED status	of f	on	Flash, 1s/1s	Flash, 0.5s/1.5s	Flash, 0.5s/0.5s	
White						
Orange						
Frequency (2 S for a cycle)						
Definition	L1	L2	L3	L4	L5	Note
Turn off						



Turn on	●	●	●	●	●	Until finish
Normal status: Idle	○	◐	○	○	○	SOC: 100~76
		○	◑	○	○	SOC: 75~51
		○	○	◐	○	SOC: 50~26
		○	○	○	◑	SOC: 25~0
Normal status: Charge	○	●	○	○	○	SOC: 100~76
		○	●	○	○	SOC: 75~51
		○	○	●	○	SOC: 50~26
		○	○	○	●	SOC: 25~0
Normal status: Discharge	○	◑	◑	◑	◑	SOC: 100~76
		○	◑	◑	◑	SOC: 75~51
		○	○	◑	◑	SOC: 50~26
		○	○	○	◑	SOC: 25~0
Protection	●	●				Temperature
			●			Voltage, SOC
				●		Current
					●	HV lock
<b>Definition</b>	<b>L1</b>	<b>L2</b>	<b>L3</b>	<b>L4</b>	<b>L5</b>	<b>Note</b>
Error	◑	Show Normal status				Add. fail, slave off line
	★	○	○	○	○	BMS error
		●				CMOS fail
			●		★	DMOS fail
			●	★	Reverse connection	
USB: Logging	★	○	○	○	●	1: download data event
		○	○	●	●	2: download data history
		○	●	●	●	3: download data

						log
		●	●	●	●	4: done, 2s
Upgrade	★	○	○	○	●	1: receiving file
		○	○	●	●	2: sending to slave
		○	●	●	●	3: upgrading
		●	●	●	●	4: will restart soon

If upgrading or USB working, will not show other status.

### BMS basic function

Protection and alarm	Management and monitor
Charge/Discharge End	Cells Balance
Charge Over Voltage	Intelligent Charge Model
Discharge Under Voltage	Charge/Discharge Current Limit
Charge/Discharge Over Current	Capacity Retention Calculate
High/Low Temperature (cell/BMS)	Administrator Monitor
Short Circuit	Operation Record
Input over voltage	Power Cable Reverse
	Soft start of inverter

### 3. Safe handling of lithium batteries guide

#### 3.1 Schematic diagram of solution

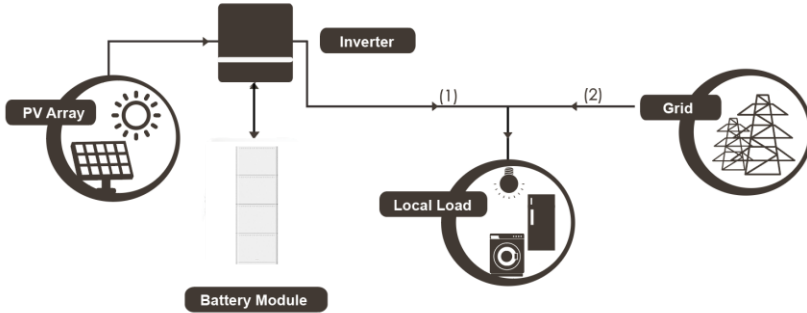







#### 3.2 Danger remind

**⚠** **DANGER**  
**DANGER LOW DC VOLTAGE INSIDE**  
**DANGER ARC FLASH & SHOCK HAZARD**

- 
- 
- 
- 
- 
- 
- 
-

- \* Do not disconnect or disassemble by non-professional personnel.
- \* Do not drop, deform, impact, cut or spearing with a sharp object.
- \* Do not place at a children or pet touchable area.
- \* Do not place near open flame or flammable material.
- \* Do not cover or wrap the product case.
- \* Do not sit or put heavy things on battery.
- \* Do not touch the leaking liquid.
- \* Avoid of direct sunlight.
- \* Avoid of moisture or liquid.
- \* The product Ingress Protection (IP) class is IP20.
- \* Make sure the grounding connection set correctly before operation.
- \* Follow the product manual to make wiring connection.
- \* If leaking, fire, wet or damaged, switch off the breaker on DC side and stay away from battery.
- \* Contact your supplier within 24 hours if anything failure happens.

### 3.3 Tools

 <p><b>Wire Cutter</b></p>	 <p><b>Crimping Modular Plier</b></p>	 <p><b>Socket Wrench</b></p>
 <p><b>Screw Driver Set</b></p>	 <p><b>Electric Screw Driver</b></p>	 <p><b>Allen Key</b></p>

#### NOTE

Use properly insulated tools to prevent accidental electric shock or short circuit. If insulated tools are not available, cover the entire exposed metal surfaces of the available tools, except their tips, with electrical tape.

### 3.4 Safety Gear

It is recommended to wear the following safety gear when dealing with the battery pack.



Insulated gloves

Safety goggles

Safety shoes

## 4. Installation and Operation

4.1 Package items — refer to package check list for detailed information

This product has one major package and three accessory kits.

1) For battery module package:



Item	Description	Set
1	Battery module	1
2	Side panel cover	2
3	Negative wire for parallel connection	1
4	Positive wire for parallel connection	1
5	Screw M6×16	1
6	Screw M5×20	4
7	Grounding wire	1
8	Warranty card	1
9	Packing list	1

**2) For Wall mounting accessory box: KIT W (To be purchased separately.)**

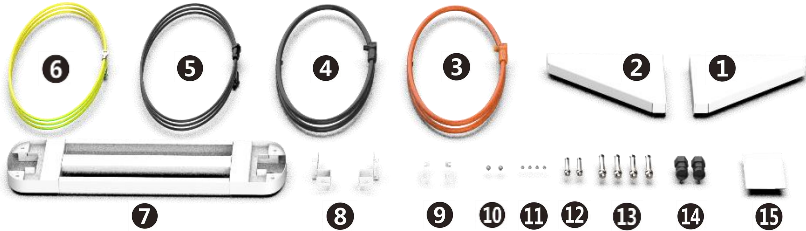

Each KIT W can be used for maximum 3 modules for wall mounting installation.

Item	Description	Set
1	Right bracket	1
2	Left bracket	1
3	Positive wire (1.2m)	1
4	Negative wire (1.2m)	1
5	Connection wire between two stacks	1
6	Grounding wire	1
7	Base	1
8	Anti-tipping bracket	2
9	Wire bracket	2
10	Screw M5×10	2
11	Screw M4×6	4
12	Expansion screw M6×60	2
13	Expansion screw M10×80	4

14	Communication port	2
15	Packing list	1

**3) For Ground mounting accessory box: KIT G (To be purchased separately.)**

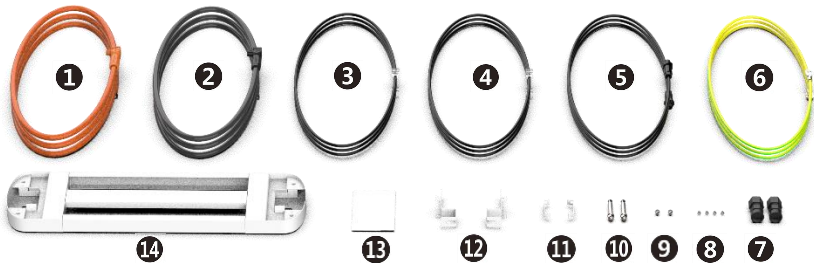

Item	Description	Set
1	Positive wire (2.5m)	1
2	Negative wire (2.5m)	1
3	Connection wire for RS 485 (2.5m)	1
4	Connection wire for CAN (2.5m)	1
5	Connection wire between two stacks	1
6	Grounding wire	1
7	Communication port	2
8	Screw M4×6	4
9	Screw M5×10	2
10	Expansion screw M6×60	2
11	Wire bracket	2
12	Anti-tipping bracket	2



13	Packing list	1
14	Base	1

**4) KIT Cable (To be purchased separately.)**



Item	Description	Set
1	Negative wire(1.2m)	1
2	Positive wire(1.2m)	1

**5) WiFi Kit (To be purchased separately.)**

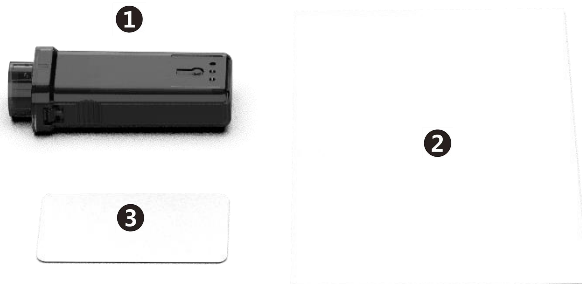

Item	Description	Set
------	-------------	-----

1	WiFi stick	1
2	Manual	1
3	Warranty card	1

## 4.2 System Working Environments Checking

### 4.2.1 Cleaning



Before installation and system power on, the dust and iron scurf must be removed to keep a clean environment.



The system cannot be installed in desert area without an enclosure to prevent from sand.

**Danger:** Battery module has active DC power at terminal all the time, must be careful to handle the modules.

### 4.2.2 Ventilation

There are no mandatory ventilation requirements for battery module, but please avoid of installation in confined area. The aeration shall avoid of high salinity, humidity or temperature.



**Caution:** Pelio system is IP65 design. But please avoid frost or direct sunlight. Out of the working temperature range will cause the battery system over / low temperature alarm or protection which further lead to the cycle life reduction. According to the environment, the cooling system or heating system should be installed if it is necessary.

### 4.2.3 Fire-extinguisher System



It must be equipped with fire-extinguisher system for safety purpose.

The fire system needs to be regularly checked to be in normal condition. Refer to the using and maintenance requirements please follow local fire equipment guidance.

### 4.2.4 Grounding System



Make sure the grounding point of the basement is stable and reliable. If the battery system is installed in an independent equipment cabin (e.g. container), make sure the grounding of the cabin is stable and reliable.

**The resistance of the grounding system must  $\leq 100m$**

**$\Omega$**

### 4.2.5 Clearance

Minimum clearance to heat source is more than 2 meters.

Minimum clearance to battery module(rack) is more than 0.2 meters.

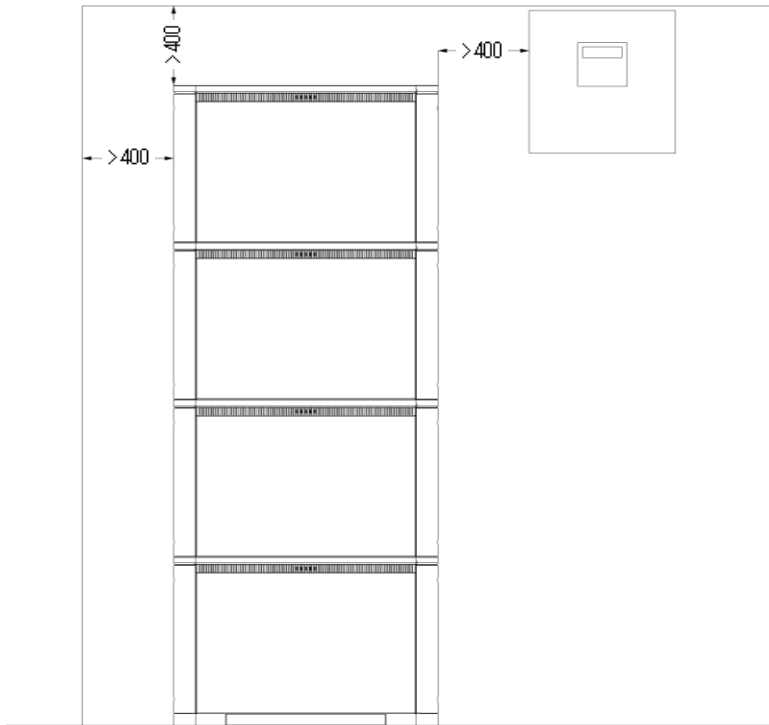

### 4.3 Preparation Before Installation



**Warning:** The battery system has potential threat to human body so it must be installed in a restricted access area;

**Warning:** The battery system can be operated by qualified and authorized personnel only.

#### 4.3.1 Operating Precautions



Single battery module is about 45kg so it must be operated by more than 2 men to move it when you don't have any handing tools.

The base is light, single person can handle with it.

### 4.3.2 Plan the Installation Site

- 1) Choose a solid wall or a flat ground capable of supporting the full weight of Pelio which depends on the Installation method that you wanted.
- 2) Make sure the area is isolated from hazards that could damage Pelio.
- 3) The temperature should be within the range of 14°F to 131°F (10°C to 55°C).
- 4) You can choose to install Pelio indoors or outdoors and it should be placed under sunshade when you want it work outdoors.
- 5) The site should be waterproof and properly ventilated. The base of Pelio cannot be placed in rain or other water sources.

### 4.3.3 Unboxing the Package

- 1) Remove all external packing ropes and open the package box.

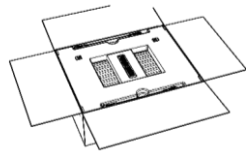

- 2) Take out the two power cables.

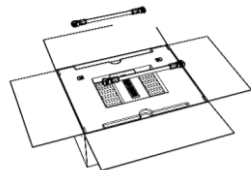

- 3) Remove the foam board on the battery module.

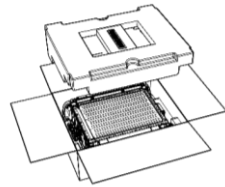

- 4) Take out the two shields.

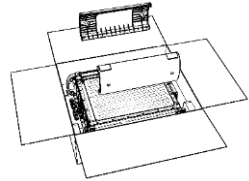

- 5) Take out the battery module. The battery module is heavy, please operate with caution

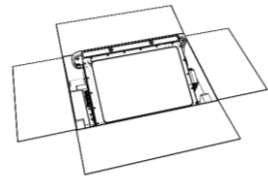

## **4.4 Wall and Ground Mounting**

### **4.4.1 Wall Mounting**

- 1) Plan the layout in advance and choose the appropriate position to anchor the brackets on the wall.

Choose a wall capable of supporting the full weight of Pelio (max. 150kg, three battery modules), with one of the following characteristics:

- Wood studs at regular intervals
- Plywood sheeting of sufficient thickness
- Solid concrete or masonry
- Metal studs of sufficient gauge

- 2) Firstly, turn the base upside down, with the bottom facing up. Set the triangle brackets on the bottom of base and lock each bracket with two screws before the brackets anchoring. The screwing must be firm without

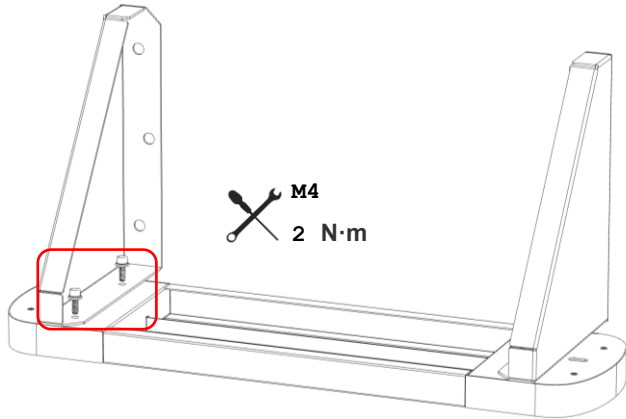

displacement.

- 3) There are two triangle brackets in total and each triangle bracket needs to be fixed on the wall with two expansion screws.

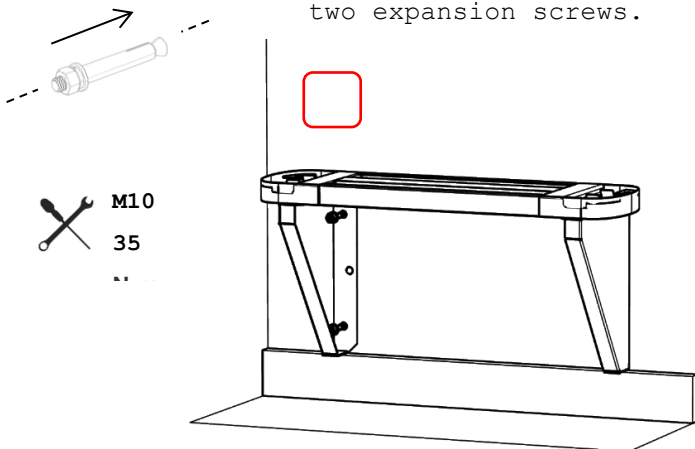

- 4) Place the battery module on the frame base and tighten the four corner screws (Each foot has a screw hole to fix the battery on the base) .

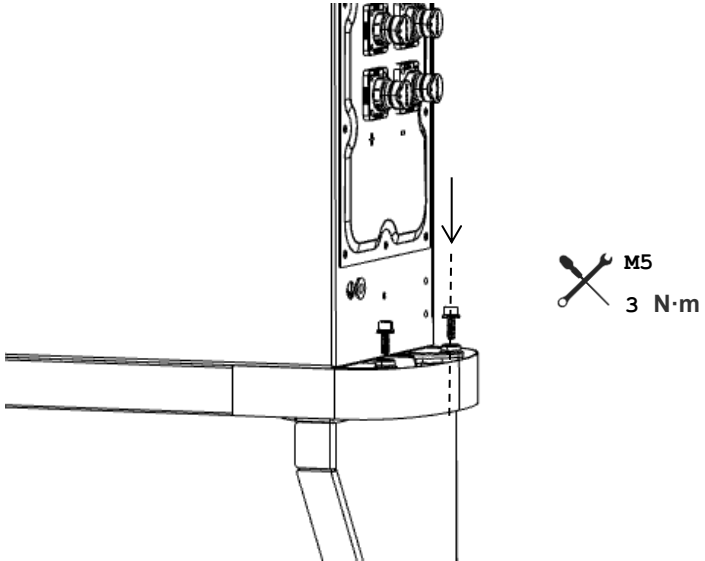

- 5) When you need to install more battery modules, lift the

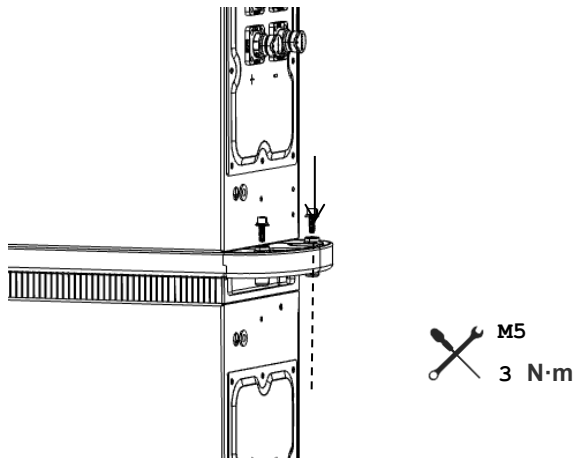



new battery module and put it on the top of previous battery module. Tighten the screws on the four feet to connect it to the battery module below.

- 6) One end of the anti-tipping bracket is fixed on the battery case and the other end is fixed on the wall. Drill holes for screws in the wall then use expansion screws to fasten the bracket on the wall. Finally, install the bracket on the battery case with screws. The bracket should be installed on the both side of the battery module.

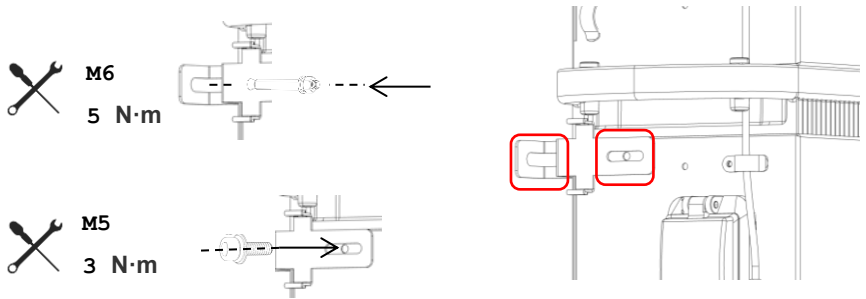

- 7) Maximum 3 in a stack for wall mounting.

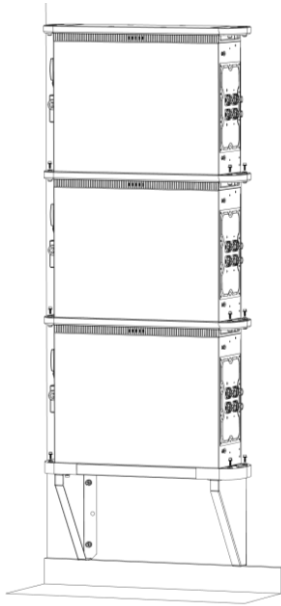

#### 4.4.2 Ground Mounting

- 1) Plan the location in advance and choose a level surface. Make sure the area is isolated from hazards that could damage Pelio, such as vehicle traffic or flooding. Consider the spacing requirements for Pelio.
- 2) Trace two screw holes on the ground and drill two screw holes at marked positions.

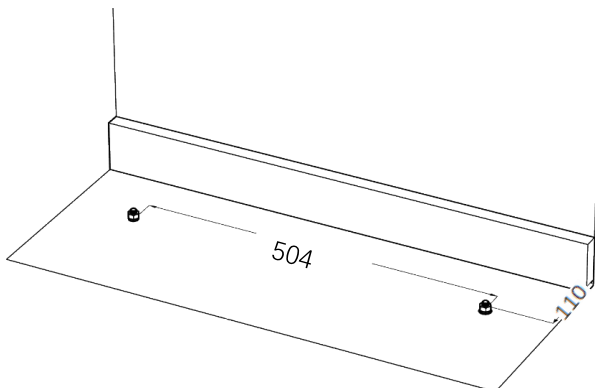

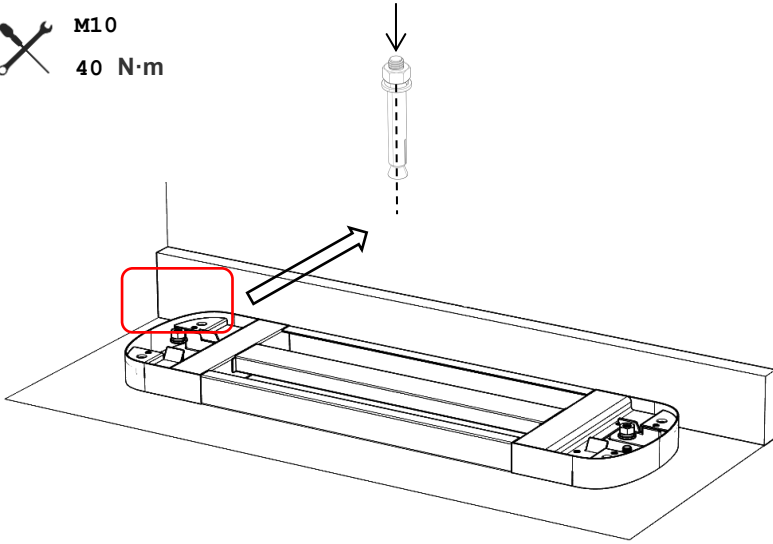

- 3) Mount the base on the ground with two expansion screws.  
The screwing must be firm without displacement.

 **M10**  
**40 N·m**



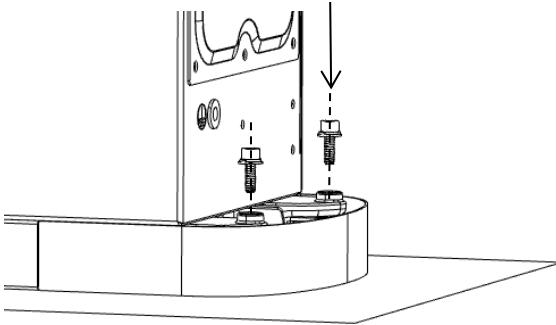
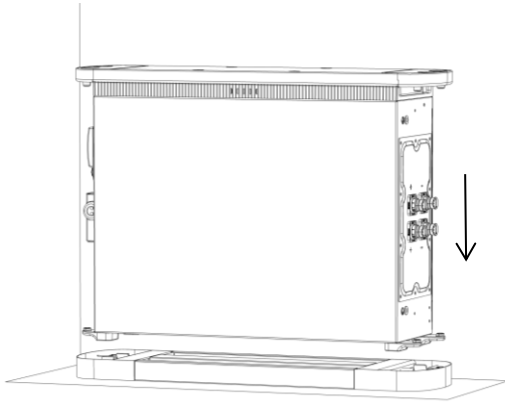

- 4) Place the battery module on the base and tighten the four corner screws (Each foot has a screw hole to fix the battery on the base).

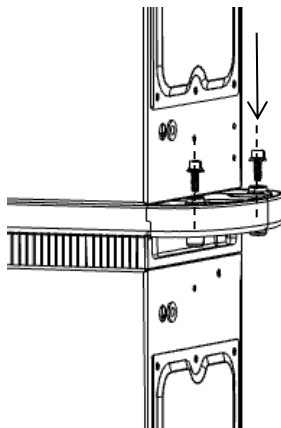

 **M5**  
**3 N·m**

- 5) When you need to install more battery modules, lift the new battery module and put it on the top of previous battery module. Tighten the screws on the four feet to connect it to the battery module below.



 **M5**  
**3 N·m**

6) One end of the anti-tipping bracket is fixed on the battery case and the other end is fixed on the wall. Drill holes for screws in the wall then use expansion screws to fasten the bracket on the wall. Finally, install the bracket on the battery case with screws. The bracket should be installed on the both side of the battery module.

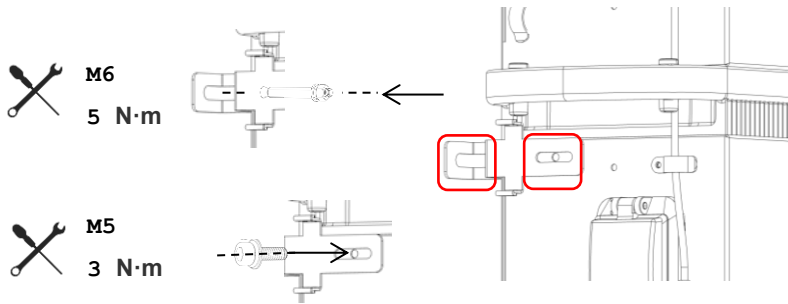

7) Maximum 4 in a stack for ground mounting.

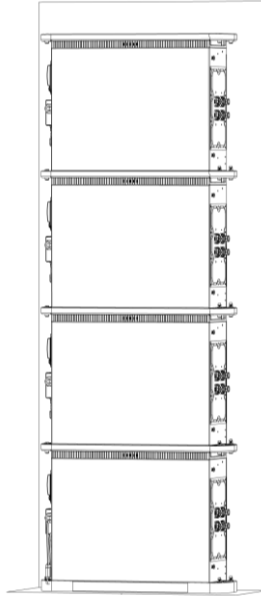

#### 4.5 Power Connection



**Danger:** All the plugs and sockets of the power cables must be not reverse connection.

**Danger:** Do not short circuit or reserved connection of the battery system's positive and negative port.



**Caution:** Wrong communication cables connection will cause the battery system failure.

- 1) There are two pairs of terminals on the right side of the battery module, please connect terminals with the cables in same color.

To connect the cable to terminal, hold the connector, press the lock button at the same time, and press it

firmly against the port until you hear a tick.

For power cables have self-locked connectors, you must keep pressing this Lock Button when you want pulling out the power plug.

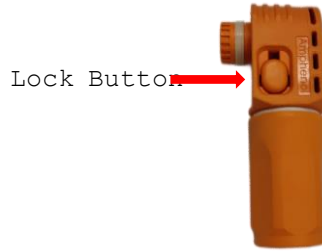
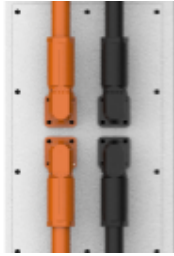

- 2) Connect the power cables between battery modules if necessary and keep the power cables through the side



handle when connecting.





- 3) Lead out the cables from the top two terminals to the inverter or the DC switches.



#### 4.6 Make Communication Connection

- 1) Please keep the communication cables through the side handle when connecting.
- 2) Connect the communication cables between battery modules: every stack has two pre-installed Linkport cables, connect one by one from Module last to the Module 1 (from **LinkPort0** to **Linkport1**).



Wire clips can be used to secure the wires.

Link 1	
Link 0	
Connecting	 Arrow to arrow
Locking	
Done	

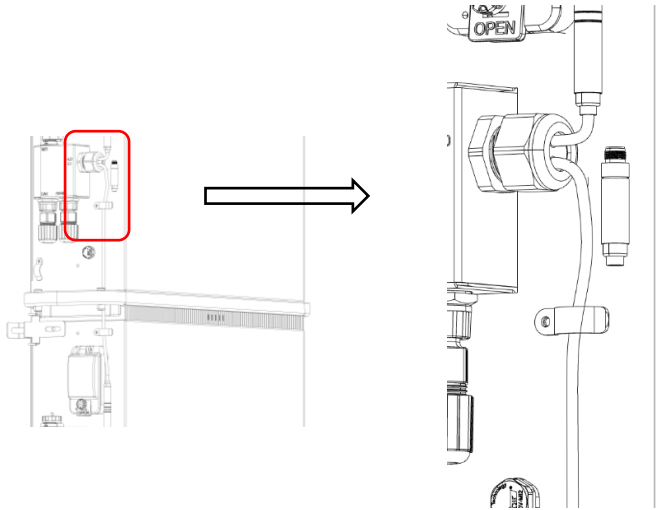



- 3) The module which **LinkPort0** is empty will be the master module (Module 1) and the communication cable to inverter should be led out from this Module. After the connection is completed, please check the cover at both ends.
- 4) Connect the communication cable between master battery stack (Module 1) and the inverter. Wire clips can be used to secure the wires too. Tighten the communication port after all of the above set up. Check the waterproof plug on the empty port and make sure all the empty ports are protected well.

1	
2	

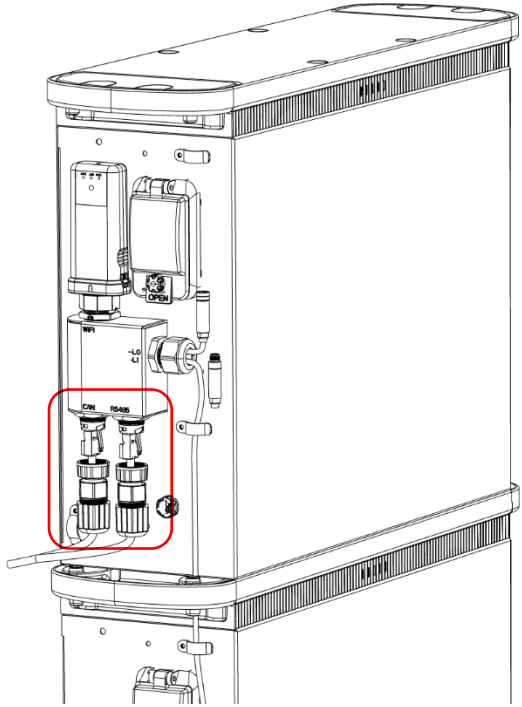
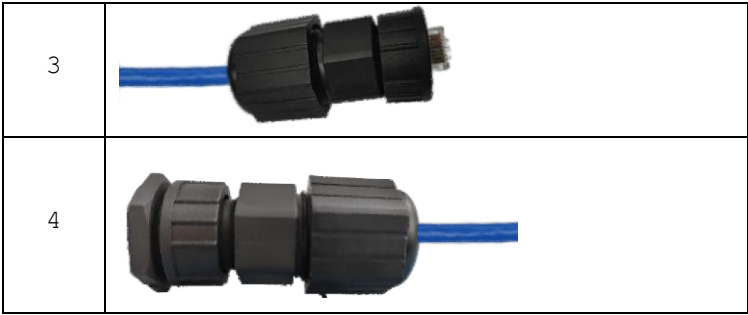

5) The length of external communication cable should not exceed 10 meters or the quality of communication will be weak.

#### 4.7 Make Grounding Connection

Grounding cables shall be 6AWG or higher yellow-green cables. After connection, the resistance from battery grounding point to ground connection point shall smaller than  $0.1\Omega$ .

- 1) Connect the grounding points of different battery modules in sequence and each battery module has two grounding point which corresponding to the upper and lower battery module.

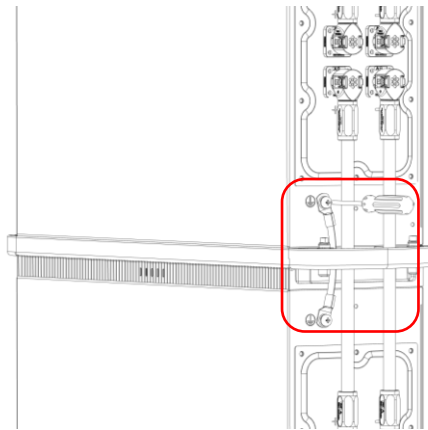

- 2) Connect the grounding cable from the bottom battery module to grounding connection point. Install the wire bracket with two screws. Use the wire bracket to organize the wiring.

  
M6  
5 N·m

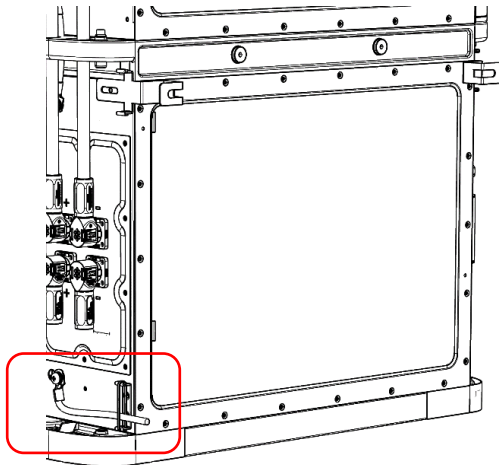
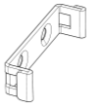

#### 4.8 Enclosure Installing

Trim panels on both sides of the battery module and cover plates at the handles of the uppermost battery module should be covered after all the connection of cables is finished.

##### **NOTE**

For convenience of operation, please make enclosure installation after all of the testing is done.

- 1) Put the side cover plate on and you can knock the knockouts when you need to lead the power cables out.

There are two pre-installed long screws on the cover plate. Put the cover plate in the proper position and what you need to do is tightening the screws. Then the cover plate is fixed.

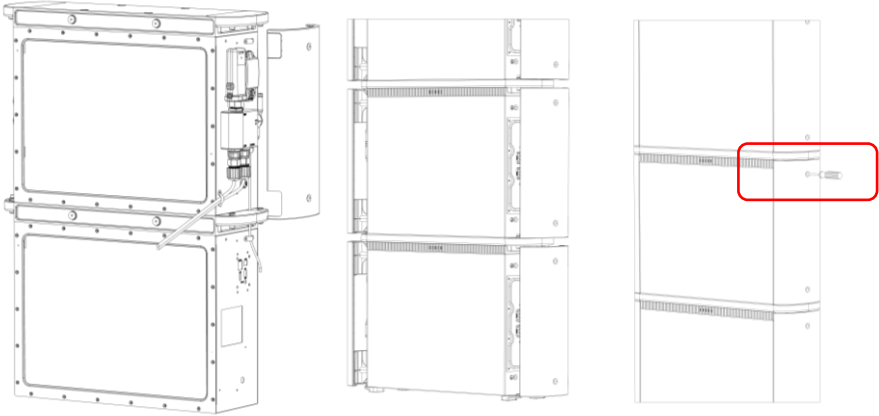

- 2) Put on the cover plates and you can knock the knockouts when you need to lead the power cables out.

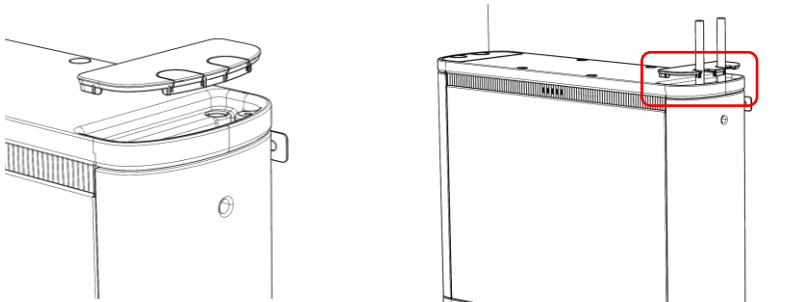

#### 4.9 Power on

Double check all the power cable and communication cable between batteries and between battery and inverter. Switch

ON the circuit breaker between battery and inverter if available.

1) Switch on all the battery Modules by power switch.



2) Press the **START button** for more than 3 second to power on, all the LED lights of battery modules will be white which means you launch it successfully. Then the rest batteries will start one by one and keep one light flashing after all the LED lights on.

3) It takes about 15 seconds to finish the start for a Pelio system of 20 modules and please confirm that all machines are started normally before operation.



**NOTE**

1) After the battery module powered on, the soft-start function takes 3sec to active. Battery will be ready to output high power after soft-start.

2) During capacity expansion or replacement, when parallel different SOC/voltage of module together, it is recommended to maintain the system in idle for  $\geq 15$ mins or till the SOC LEDs becomes similar ( $\leq 1$ dot difference) before normal operation.

#### 4.10 Power off

- 1) Turn external power source off.
- 2) Press START switch of master battery module for more than 3 seconds since and all LED lights will be white. Then all of the battery modules will turn off (the battery module will shut done itself alone if you do not



turn off the master battery).

- 3) It takes about 5 seconds to finish the closing for a Pelio system of 20 modules and please do not carry out any operation during the power-off process.
- 4) Switch all the Power switches OFF.
- 5) Switch OFF the breaker between battery system and inverter, if available.



## 4.11 Guide of USB

### 1) Log Export Mode

When you want to download data, insert the USB flash disk and wait for the result without any other operation. At the beginning, L1 is flashing and L5 is on then the lights will be on one by one. When all lights except L1 are on, it means that the downloading completed and you can unplug the USB flash disk.

### 2) Upgrade Mode

When you want to upgrade, insert the pre-set USB flash disk and wait for the result without any other operation. At the beginning, L1 is flashing and L5 is on then the lights will be on one by one. When all lights except L1 are on, it means that upgrade completed and system will restart soon.

## NOTE

The USB flash disk is not provided with the Pelio, please contact local distributor to get it if necessary.

## 4.12 User Manual of WiFi module

Assemble logger to the device communication interface as shown in the diagram and the WiFi module will run automatically after the system starting.

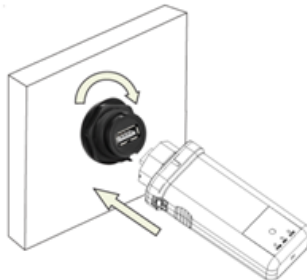



## NOTE





The WiFi module is not provided with the Pelio, please contact local distributor to get it if necessary.

#### 4.13 Multi-group mode

1) Suitable protection breaker between battery system and inverter is required.

#### 2) Connection Configuration Table

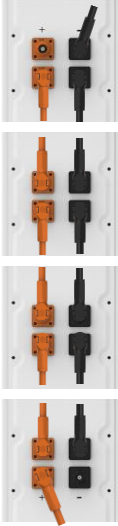
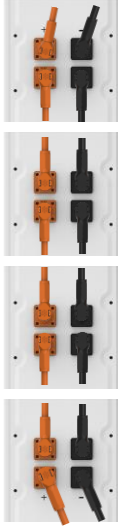
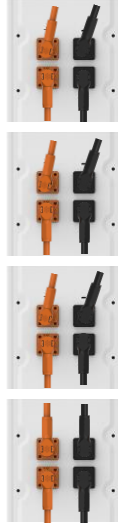
Module	W	G	Connection 1	Connection 2	Connection 3	Connection 4
1	√	√	 80A /1 pair out			
2	√	√	 80A /1 pair out	 160A /2 pairs out		

3	√	√	 <p>80A / 1 pair out</p>	 <p>160A / 2 pair out</p>	 <p>240A / 3 pairs out</p>	
4		√	 <p>80A / 1 pair out</p>	 <p>160A / 2 pairs out</p>	 <p>240A / 3 pairs out</p>	 <p>320A / 4 pairs out</p>

Module	Connection	Cable	Rated power/kW	Rated Current/A	Capacity /kWh
1	1	100A* 1set	4	80	5.12

2	1	100A* 1set	5	100	10.24
	2	100A* 2set	8	160	
3	1	100A* 1set	5	100	15.36
	2	100A* 2set	10	200	
	3	100A* 3set	12	240	
4	1	100A* 1set	5	100	20.48
	2	100A* 2set	10	200	
	3	100A* 3set	15	300	
	4	100A* 4set	16	320	

### 3) Multi-group connection

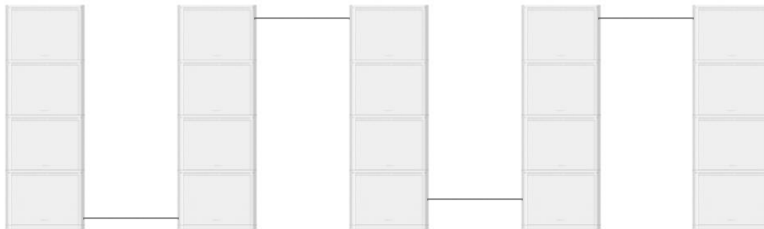

The connection of power cables between battery stacks need the help of hub.

### 4) Configuration Table

Quantity	Capacity/kWh	Rated Current/A	Rated Power/kW
1	5.12	80	4

2	10.24	160	8
3	15.36	240	12
4	20.48	320	16
5	25.6	400	20
6	30.72	480	24
7	35.84	560	28
8	40.96	640	32
9	46.08	720	36
10	51.2	800	40
11	56.32	880	44
12	61.44	960	48
13	66.56	1040	52
14	71.68	1120	56
15	76.8	1200	60
16	81.92	1280	64
17	87.04	1360	68
18	92.16	1440	72
19	97.28	1520	76
20	102.4	1600	80

## 5 Trouble shooting



- Communication related problem

Unable to communicate with inverter on compatible list.

Possible conditions:

- 1) RS485: baud rate. Check the dip switch1, set to correct one, and restart. All master battery shall be the same.
- 2) CAN: pin. Try connect the CAN-H, L,GND only and do not connect other pins to inverter.

- Functional related problem

Protection	●	●				Temperature
			●			Voltage, SOC
				●		Current
					●	HV lock
Error	 	Show Normal status				Add. fail, slave off line
		○	○	○	○	BMS error
		●				CMOS fail
			●			DMOS fail
				●		Reverse connection

sequence of checking:

- 1) Whether the battery can be turned on or not.
- 2) If battery is turned on, check the LED color (orange or not) and status of LED (on or flashing).
- 3) If the light is off, check whether the battery can be charged/discharged or not.

Possible conditions:

- 1) Battery cannot turn on, switch ON and press the SW, the

lights are all no lighting or flashing.

- a) Capacity too low, or module over discharged.

solution: use a charge or inverter to provide 48-56.8V voltage. If battery can start, then keep charge the module and use monitor tools to check the battery log.

If battery terminal voltage is  $\leq 45\text{Vdc}$ , please use  $\leq 0.05\text{C}$  to slowly charge the module to avoid affect to SOH.

If battery terminal voltage is  $> 45\text{Vdc}$ , it can use  $\leq 0.5\text{C}$  to charge.

If battery cannot start, turn off battery and repair.

- 2) The battery can turn on but the battery cannot be charged or discharged.

#### Temperature

- a) Above  $60^{\circ}\text{C}$  or under  $-10^{\circ}\text{C}$ , the battery could not work.

Solution: move battery to the normal operating temperature range between  $0^{\circ}\text{C}$  and  $50^{\circ}\text{C}$

#### Voltage, SOC

- b) Low Voltage: When the battery discharges to 45V or less, battery protection will turn on.

Solution: Charge the battery till the red light turns off.

- c) Cell voltage high. The module voltage is lower than 56V, SOC LED does not all on. The module protection disappears when discharge.

Solution: keep charge the module by 55-56V or keep the system cycle. The BMS can balance the cell during cycling.

- d) High Voltage: If charging voltage above 57V, battery protection will turn on.

Solution: Check whether voltage is too high or not, if it is, to change the settings on power supply side. And discharge the module.

#### Current

- a) If current exceeds 90A, battery protection will turn on.  
Solution: Check whether current is too large or not, if it is, change the settings on power supply side.

#### HV lock

- a) Cell voltage higher than 4V or module voltage higher than 56.8V.

Solution: Battery system requires properly established communication with inverter and correctly settings on inverter to run safely. Check the setting of the inverter or charger, the charge voltage shall be 56-56.8Vdc; Check the communication between battery system and inverter whether established or not; Check the ADD switch on battery module whether is set correctly or not;

Under this condition, the BMS remains functional without damage. Just leave the module switched OFF and wait for the battery voltage drop down naturally(15mins) then restart. If then no alarm comes out, this means the module is ready for work

#### BMS error

Solution: Switch off the module and contact your local distributor.

#### CMOS fail

- a) The fuse blew out.

Solution: Power off all battery and inverters. Disconnect breaker. Check the cable connection and disconnect all power cables. Check the power port



damaged or not. Check the setting of inverter or charger, check the communication between inverter and battery system.

Try turn on the single module, without any cable connected. If the error still, switch off the module and contact your local distributor for repair.

DMOS fail

a) The fuse blew out.

Solution: Power off all battery and inverters. Disconnect breaker. Check the cable connection and disconnect all power cables. Check the power port damaged or not. Check the setting of inverter or charger, check the communication between inverter and battery system.

Try turn on the single module, without any cable connected. If the error still, switch off the module and contact your local distributor for repair.

Reverse connection

a) Reverse connection of cables.

Solution: Power off all battery and inverters. Disconnect breaker. Check the cable connection and disconnect all power cables. Check the power port damaged or not. Then try turn on the single module, without any cable connected. If no alarm, then it is reverse connection of cables. Switch off the module and contact your local distributor.

**Excluding the points above, if the faulty still cannot be identified, turn off battery and contact your local distributor.**

Emergency Situations

### 1) Leaking Batteries

If the battery pack leaks electrolyte, avoid contact with the leaking liquid or gas. If one is exposed to the leaked substance, immediately perform the actions described below.

a) Inhalation: Evacuate the contaminated area and seek medical attention.

b) Contact with eyes: Rinse eyes with flowing water for 15 minutes and seek medical attention as soon as possible.

c) Contact with skin: Wash the affected area thoroughly with soap and water and seek medical attention.

Ingestion: Induce vomiting and seek medical attention.

### 2) Fire

If detect the battery cell is catching fire, firstly cut off the external power source. Then use vast of water for suppression. After fire suppressed, soaking battery within water and contact Pylontech or an authorized dealer.

If detect the cabling or other components (not battery cell) is catching fire. Firstly, cut off the external power source. Then use dry powder fire or carbon dioxide extinguisher for suppression.

### 3) Wet Batteries

If the battery module connector is wet or battery module submerged in water, do not let people access it, and then contact Pylontech or an authorized dealer for technical support. Cut off all power switch on inverter side.

### 4) Damaged Batteries

Damaged batteries are dangerous and must be handled with the utmost care. They are not fit for use and may pose a danger to people or property. If the battery pack seems to be damaged, pack it in its original container, and

then return it to Pylontech or an authorized dealer.



**Caution**

Damaged batteries may leak electrolyte or produce flammable gas.

## 6 Remarks

### Recycle and disposal

In case a battery (normal condition or damaged) needs disposal or needs recycling, it shall follow the local recycling regulation (i.e. Regulation (EC) N° 1013/2006 among European Union) to process, and using the best available techniques to achieve a relevant recycling efficiency.

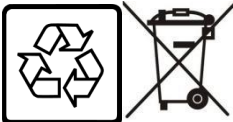

**Li-ion** ████████

### Storage, Maintenance and Expansion

- 1) It is required to charge the battery at least once every 6 months, for this charge maintenance make sure the SOC is charged to higher than 90%. If you want to keep storing the battery, it is recommended to discharge to 50-70%
- 2) Every year after installation. The connection of power connector, grounding point, power cable and screw are suggested to be checked. Make sure there is no loose, no broken, no corrosion at connection point. Check the installation environment such as dust, water, insect etc. make sure it is suitable for IP65 battery system.
- 3) If the battery is stored for long time, it is required to charge them every six months, and the SOC should be higher than 90%.
- 4) A new battery module can be adding onto an existing system at any time. Please make sure the new battery is

acting as the master. The new module, due to a higher SOH may have a difference on SOC with existing system, but it will not affect the parallel connection system performance.











**PYLONTECH**

**Pylon Technologies Co., Ltd.**

Floor 5<sup>th</sup>, No. 72, Lane 887, ZuChongzhi Road, Zhangjiang Hi-Tech Park Pudong, Shanghai 201203, China

**T**+86-21-51317699 | **F** +86-21-51317698

**E** [service@pylontech.com.cn](mailto:service@pylontech.com.cn)

**W** [www.pylontech.com.cn](http://www.pylontech.com.cn)