

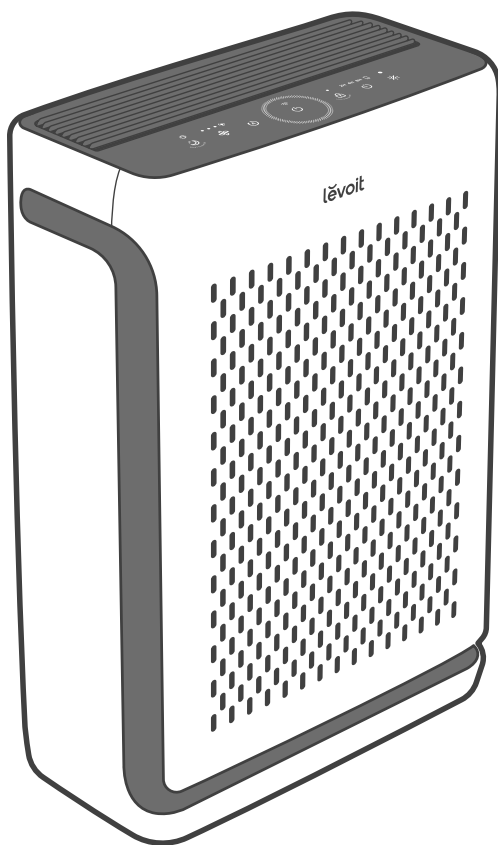

USER MANUAL

Vital 100S

Smart True HEPA Air Purifier



Questions or Concerns?

Please contact us Mon–Fri, 9:00 am–5:00 pm PST/PDT at support@levoit.com or at (888) 726-8520.

Table of Contents

Package Contents	2
Specifications	2
Safety Information	3
Getting to Know Your Smart Air Purifier	5
Controls & Display	6
Getting Started	7
Using Your Smart Air Purifier	10
About the Filter	15
Care & Maintenance	17
Troubleshooting	21
Warranty Information	25
Customer Support	26

Package Contents

- 1 x Smart Air Purifier
- 1 x Washable Pre-Filter (Pre-Installed)
- 1 x True HEPA / Activated Carbon Filter (Pre-Installed)
- 1 x User Manual
- 1 x Quick Start Guide
- 1 x AC Power Adapter

Specifications

Model	LAP-V102S-WUS
Power Supply	24V $\overline{=}$ 1.5A
Rated Power	35W
Ideal Room Size	<p>219 ft² / 20 m²</p> <ul style="list-style-type: none">This Ideal Room Size is based on 5 air changes per hour (ACH). <p>548 ft² / 50 m²</p> <ul style="list-style-type: none">This Ideal Room Size is based on 2 air changes per hour (ACH). <p>Note: Effective for larger rooms but purification will take longer.</p>
CADR (CFM)	141 CFM / 240 m ³ /h
Operating Conditions	<p>Temperature: 14°–104°F / -10°–40°C</p> <p>Humidity: ≤ 85% RH</p>
Noise Level	23–52dB
Dimensions	12.8 x 6.4 x 16.1 in / 32.5 x 16.3 x 41 cm
Weight	7 lb / 3.4 kg
Power Adapter	Input: 100–240V \sim 50/60Hz Output: 24V $\overline{=}$ 1.5A

Note: To access additional smart functions, download the free VeSync app (see page 9).

READ AND SAVE THESE INSTRUCTIONS

SAFETY INFORMATION

To reduce the risk of fire, electric shock, or other injury, follow all instructions and safety guidelines.

General Safety

- **Only** use your air purifier as described in this manual.
- **Do not** use without removing the plastic wrap from the filter. The air purifier will not filter air and may overheat, causing a fire hazard.
- **Do not** use your air purifier outdoors.
- Keep your air purifier away from water, and wet or damp areas. **Never** place in water or liquid.
- **Do not** use in excessively humid areas.
- Keep your air purifier away from heat sources.
- **Do not** use where combustible gases, vapors, metallic dust, aerosol (spray) products, or fumes from industrial oil are present.
- Keep 5 ft / 1.5 m away from where oxygen is being administered.
- Children should be supervised to ensure that they **do not** play with the air purifier.
- **Do not** allow children to play with the plastic packaging. Immediately discard the plastic after unwrapping the filter.
- **Do not** place anything into any opening on the air purifier.
- Children should be supervised to ensure they **do not** insert fingers or objects into the vent openings.
- **Do not** sit or place heavy objects on the air purifier.
- Keep the inside of the air purifier dry. To prevent moisture buildup, avoid placing in rooms with major temperature changes.
- **Always** unplug your air purifier before servicing (such as changing the filter).
- **Do not** use your air purifier if it is damaged or not working correctly, or if the cord or plug is damaged. **Do not** try to repair it yourself. Contact **Customer Support** (see page 26).
- **WARNING:** To reduce the risk of fire or electric shock, **do not** use this air purifier with any solid-state speed controls (such as a dimmer switch).
- Children should not clean or perform maintenance on the air purifier without supervision.
- This air purifier is not to be used by persons (including children) with reduced physical, sensory, or mental capacities, or lack of experience and knowledge, unless they have been given supervision or instruction concerning the use of the appliance by a person responsible for their safety.
- Not for commercial use. Household use **only**.

SAFETY INFORMATION (CONT.)

Power Adapter & Cord

- Keep the air purifier near the outlet it is plugged into.
- **Never** place the cord near any heat source.
- **Do not** cover the cord with a rug, carpet, or other covering. **Do not** place the cord under furniture or appliances.
- Keep the cord out of areas where people walk often. Place the cord where it will not be tripped over.
- This air purifier is **only** to be used with the power supply adapter provided with the air purifier
- If the power adapter cord is damaged, it must be replaced by Arovast Corporation or similarly qualified persons in order to avoid an electric or fire hazard. Please contact **Customer Support** (see page 26).
- This air purifier's power adapter uses standard North American 120V, 60Hz outlets. If using outside the US or Canada, check for compatibility.
- Unplugging the power adapter will disable remote control of the air purifier and temporarily disconnect the air purifier from VeSync and other third-party apps.

Electromagnetic Fields (EMF)

Your Levoit air purifier complies with all standards regarding electromagnetic fields (EMF). If handled properly and according to the instructions in this user manual, the appliance is safe to use based on scientific evidence available today.

GETTING TO KNOW YOUR SMART AIR PURIFIER

- A. Check Filter Indicator
- B. Fan Speed Indicators
- C. Auto Mode Button
- D. On/Off Button
- E. Wi-Fi® Indicator
- F. Display Lock Indicator
- G. Timer Indicators
- H. Light Sensor
- I. Sleep Mode Button
- J. Fan Speed Button
- K. Air Quality Indicator
- L. Display Lock Button
- M. Timer Button
- N. Display Off Button
- O. Front Cover
- P. Washable Pre-Filter
- Q. True HEPA / Activated Carbon Filter
- R. AirSight™ Infrared Dust Sensor
- S. Dust Sensor Cover
- T. Power Adapter Input
- U. Power Adapter

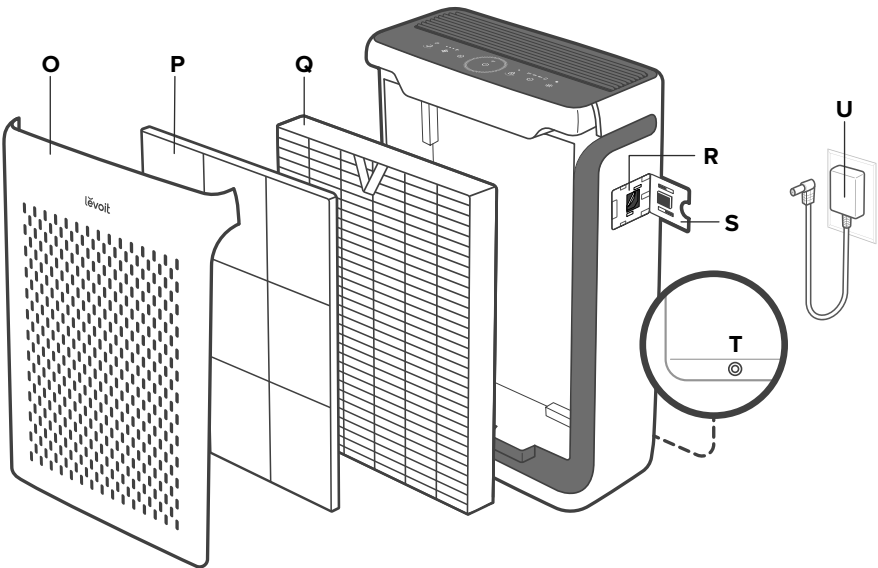
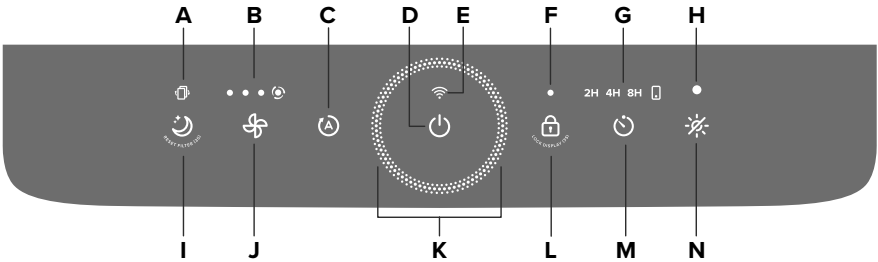

CONTROLS & DISPLAY

Note: You can also use the VeSync app to control these functions, as well as additional app-only features (see page 13).



Auto Mode Button

- Turns Auto Mode on (see page 10).



On/Off Button

- Turns the air purifier on/off.
- Press and hold for 3 seconds to connect the air purifier to the VeSync app. See the in-app instructions for more information (see page 9).
- Press and hold for 3 seconds to reset the air purifier and disconnect from Wi-Fi® (see page 9).



Sleep Mode Button

- Turns Sleep Mode on (see page 10).
- Press and hold for 3 seconds to reset the Check Filter Indicator.



Check Filter Indicator

- Lights up red when the filter should be checked (see **Check Filter Indicator**, page 17).
- To reset the Check Filter Indicator, press and hold  for 3 seconds. The Check Filter Indicator will flash 3 times, and turn off.



Wi-Fi Indicator

- Blinks when connecting to the VeSync app, lights up when connected to VeSync, and is off when disconnected from VeSync. See the VeSync in-app instructions for more information (see page 9).



Fan Speed Button & Indicators

- Cycles through fan speeds: low (1 indicator will light up), medium (2 indicators), high (3 indicators), and turbo (4 indicators).
- Tapping  while the air purifier is in Auto Mode, Sleep Mode, or Pet Mode (when the display is lit up) will exit that mode.

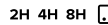

Timer Button & Indicators

- Cycles through timer options: 2 hours, 4 hours, and 8 hours (see page 11).

Note: The timer indicators will light up with the corresponding timer selected.

-  lights up when the timer function is used through the VeSync app.

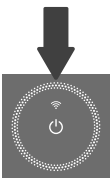

Air Quality Indicator

- These indicator rings use an automatic infrared dust sensor to display the air quality: Blue (Very Good), Green (Good), Orange (Moderate), Red (Bad).

CONTROLS & DISPLAY (CONT.)



Display Lock Button & Indicator

- Prevents current settings from being changed (see page 12). Press and hold for 3 seconds to lock and unlock the display.

Note: Display Lock can also be controlled through the VeSync app.

- The Display Lock Indicator will light up when the display is locked and blink when any other button is tapped to indicate the display is locked.



Display Off Button

- Turns the display off (see page 11).
- Tap any button to turn the display back on.



Light Sensor

- The Light Sensor detects the amount of light in the room to automatically adjust the air purifier settings (see **Light Detection**, page 11).
- Light Detection can be turned on/off in the VeSync app (see page 11).

GETTING STARTED

1. Place the air purifier on a flat, stable surface such as the floor.
2. Pull both sides of the front cover to remove it. [Figure 1.1]

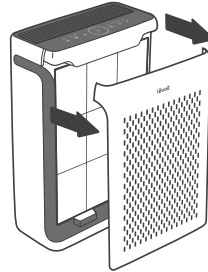

Figure 1.1

3. Push the pre-filter's tabs inward and pull to remove the pre-filter from the air purifier. [Figure 1.2]

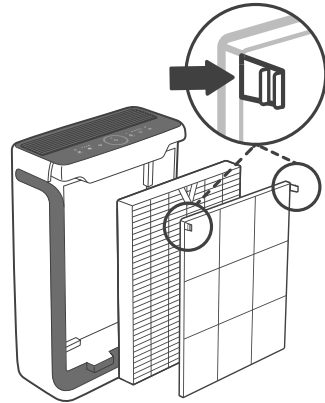

Figure 1.2

GETTING STARTED (CONT.)

4. Remove the True HEPA / Activated Carbon Filter from inside the air purifier.
5. Remove the plastic packaging from the filter and place the filter and the pre-filter back into the air purifier. *[Figure 1.3]*

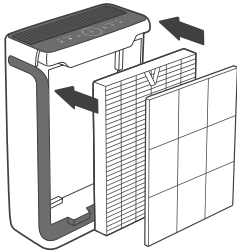
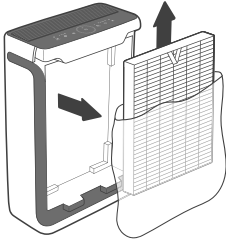

Figure 1.3

Note: Make sure the True HEPA filter (the side with the ribbon handle) is facing outward when you insert the filter. *[Figure 1.4]*

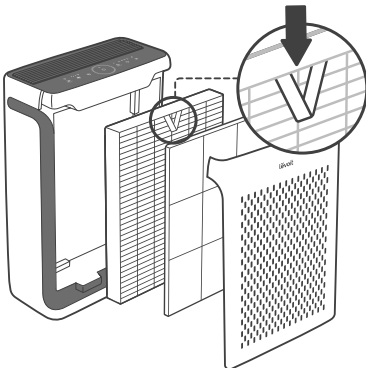

Figure 1.4

6. Place the front cover on the air purifier. Make sure to align the tabs on the cover with the slots on the bottom of the air purifier. *[Figure 1.5]*

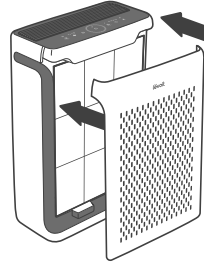

Figure 1.5

7. Insert the power adapter plug into the back of the air purifier. *[Figure 1.6]*

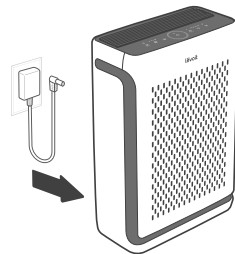

Figure 1.6

8. When using the air purifier, allow at least 15 inches / 38 cm of clearance from the front of the air purifier. Keep away from anything that would block air flow, such as curtains. *[Figure 1.7]*

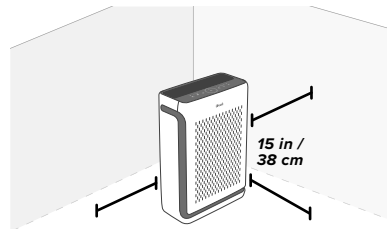

Figure 1.7

VeSync App Setup

Note: The VeSync app is continually being improved and may change over time. If there are any differences, follow the in-app instructions.

1. To download the VeSync app, scan the QR code or search “VeSync” in the Apple App Store® or Google Play Store.



Note: For Android™ users, choose “Allow” to use VeSync.

2. Open the VeSync app. **Log In** or **Sign Up**.

Note: You must create your own VeSync account to use third-party services and products. These will not work with a guest account. With a VeSync account, you can also allow your family and friends to control your smart air purifier.

3. Follow the in-app instructions to set up your smart air purifier.

Note: Your phone must have Location turned on while your phone is connecting to your smart air purifier. This is required to establish the Bluetooth® connection. You can turn Location off after your smart air purifier is finished connecting to the VeSync app.

Wi-Fi® Connection

- To disconnect Wi-Fi, press and hold  for 15 seconds until the Wi-Fi indicator turns off. This will restore the smart air purifier's default settings and disconnect it from the VeSync app.
- To reconnect, please follow the instructions in the VeSync app for adding a device.



Connect with Amazon Alexa or Google Assistant™

You can use the VeSync app to connect your smart air purifier to **Amazon Alexa** or **Google Assistant™**. Please follow the in-app instructions to set up your voice assistant.

Note: You must create your own VeSync account to access voice assistants.

USING YOUR SMART AIR PURIFIER

Note: Using the VeSync app allows you to control your air purifier remotely and access additional functions and features (see page 13).

1. Plug in and tap  to turn on the air purifier. The fan will start on low.
2. Tap  to change fan speed between low, medium, high, and turbo.

Note:

- The fan speed indicators are not buttons and only display the fan speed setting.
- The fan speed indicators will light up when active, 1 indicator will light up for low, 2 for medium, 3 for high, and 4 for turbo.
- Turbo fan speed (4 indicator lights) is the loudest, but cleans air the quickest.
- For best results, or to address a specific air quality issue such as smoke, run the air purifier on turbo for 15–20 minutes before using a lower speed.
- To effectively clean air, keep windows and doors closed while the air purifier is on.

Sleep Mode

Sleep Mode operates quietly by using a fan speed lower than low speed.



1. Tap  to turn Sleep Mode on.
2. Sleep Mode will turn off the display after 6 seconds if no other buttons are tapped.
3. To switch from Sleep Mode, tap Auto Mode or select a fan speed on the air purifier's display or in the VeSync app.

Note:

- When the display is turned off, tap any button to turn the display back on. If you don't tap another button, the display will turn off again after 6 seconds.
-  will still turn on and stay on if it's time to check your filter (see page 17).

Auto Mode

Auto Mode uses AirSight™, an infrared dust sensor inside the air purifier, to adjust the fan speed automatically based on air quality. For example, if the air quality is bad, the fan will automatically be set to high speed.

1. Tap  to turn Auto Mode on.
2.  will light up while Auto Mode is on.
3. To switch from Auto Mode, tap Sleep Mode or select a fan speed on the air purifier's display or in the VeSync app.

Air Quality Indicator Chart		
Indicator Color	Air Quality	Auto Mode Fan Speed
Blue	Very Good	Sleep Mode
Green	Good	Low
Orange	Moderate	Medium
Red	Bad	High

Note:

- Auto Mode does not use the turbo fan speed.
- The VeSync app also supports Efficient Auto Mode and Quiet Auto Mode (see page 14).

USING YOUR SMART AIR PURIFIER (CONT.)

Light Detection

You can turn on/off Light Detection in the VeSync app. When this mode is turned on, the light sensor will automatically adjust air purifier settings based on the amount of light in the room.

- The display will automatically turn off when the room gets dark. If the air purifier is in Auto Mode or Pet Mode, it will not use the high or turbo fan speeds, even if the air quality is poor, to avoid making too much noise.
- When the room becomes light again, the air purifier will return to its previous settings. The display will automatically turn back on, and Auto Mode will no longer be limited.

Timer

You can manually set the timer for 2, 4, or 8 hours using the  button. You can also set the timer for 1–24 hours through the VeSync app.

1. Tap  repeatedly to select a time. The timer will start automatically.

Note:

- *The indicators are not buttons and cannot be used to select a time.*
- *The timer indicators will light up blue when active.*
- *When the timer is set through the VeSync app, the  indicator will light up instead. Once the timer has finished, the air purifier will turn off.*



2. To cancel the timer, tap  until all timer indicators are off. You can also turn the timer off in the VeSync app.

Note:

- *You can change the fan speed at any time while the timer is on.*
- *The timer will restart if the time is changed.*

Display Off

This turns off the display lights on the air purifier, including button lights and indicator lights (except the Check Filter Indicator).



1. Tap  to turn off the display.
2. Tap any button to temporarily turn the display back on. If you don't tap another button, the display will turn back off after 6 seconds.
3. Tap  to turn the display back on. The display will stay on.

Note: *The Check Filter Indicator will still turn on and stay on if it's time to check your filter (see page 17).*

USING YOUR SMART AIR PURIFIER (CONT.)

Display Lock

When the air purifier is on, you can lock the display to prevent settings from being accidentally changed. Buttons will not respond to being tapped.

1. Press and hold  for 3 seconds to lock the display. The Display Lock Indicator will light up above the  button.

Note: *If the display is turned off, the Display Lock Indicator will flash 3 times to show that the display has been locked, then turn off.*

2. The Display Lock Indicator will blink when any other button is tapped to indicate that Display Lock is on.
3. Press and hold  again for 3 seconds to unlock the display. The Display Lock Indicator will turn off.

Standby Mode

The air purifier is in Standby Mode when it is turned off, but plugged in.

Note:

- *In Standby Mode, the infrared dust sensor will still detect the surrounding air quality and give you updates in the VeSync app.*
- *Display Lock (available in the VeSync app) can be used while the air purifier is in Standby Mode to keep the air purifier from being turned back on.*

Memory Function

When the air purifier is in standby or turned off and unplugged, it will remember its previous fan speed, Sleep Mode, Auto Mode, Pet Mode, and in-app Display and Light Detection settings.

Note: *The air purifier will not remember timers.*

USING YOUR SMART AIR PURIFIER (CONT.)

VeSync App Functions

The VeSync app allows you to access additional smart air purifier functions, including those listed below. As the app develops, more features may become available.

Remote Control

- Change any air purifier settings through the app, even while Display Lock is on.

Air Quality Updates

- View real-time air quality updates in the app.
- See your air quality history for the previous 4 weeks.

Pet Mode

- Pet Mode is efficient at filtering allergens from the air while conserving energy.
- When Pet Mode is on, the air purifier runs for 15 minutes at high speed (3 indicator lights), then 60 minutes at medium speed (2 indicators), and cycles between the two fan speeds. The corresponding fan speed indicators and  on the air purifier's display will light up.
- When Pet Mode is on, and the light sensor detects the room is dark, the display will turn off and limit Pet Mode to medium fan speed (2 indicators), to avoid making too much noise. When the light sensor detects that the room is lit again, Pet Mode will no longer be limited, and the air purifier will run at medium fan speed (2 indicators) for 30 minutes, then run at high (3 indicators) for 15 minutes. After this, the normal Pet Mode cycle will start (15 minutes at high speed, then 60 minutes at medium speed).
- To turn off Pet Mode, tap Auto Mode, Sleep Mode, or select a fan speed on the air purifier's display or in the VeSync app.

Note:

- *The corresponding fan speed indicators will light up depending on which fan speed is currently running.*
- *Pet Mode will stay on unless you select a different mode or fan speed.*

USING YOUR SMART AIR PURIFIER (CONT.)

Auto Mode

Access additional auto modes: Quiet Auto Mode and Efficient Auto Mode.

- Quiet Auto Mode uses the medium fan speed (2 indicator lights) instead of the high or turbo fan speeds, even when the air quality is poor, to avoid making too much noise.
- Efficient Auto Mode lets you choose the size of the area you want to purify. The air purifier will use the turbo fan speed to clean the air for a designated amount of time. This time is based on 1 ACH and the size of the room, meaning how long it takes for the air purifier to clean all the air in your room one time, regardless of the air quality. After this, the mode will adjust the fan speed according to the actual detected air quality in the room.

Note: *Efficient Auto Mode is useful for purifying odors from the air. The air purifier's dust sensor can only detect particles in the air, not smells. Efficient Auto Mode does not rely on the dust sensor, but the room size instead.*

Display Lock

- Turn the Display Lock on/off.
- Display Lock prevents current settings from being changed on the air purifier.
-  will flash to indicate that the display is locked.

Schedules

- Create and customize schedules for your air purifier to match your routines.

Timer Function

- Set a timer between 1–24 hours.
- Easily view the exact time remaining on a timer.

Filter Replacement Info

- Keep tabs on the remaining filter life by checking the filter life percentage in the app.
- Shop for replacement filters.

ABOUT THE FILTER

The air purifier uses a 3-stage filtration system to purify air.

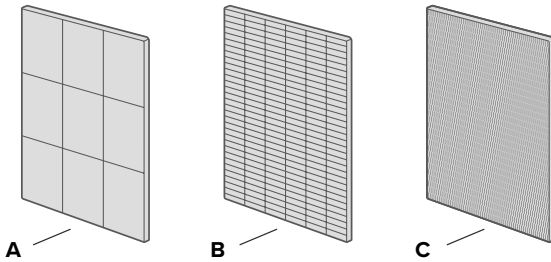

A. Washable Pre-Filter

- Captures large particles such as dust, lint, fibers, hair, and pet fur.
- Maximizes the filter's life by protecting it.
- Removable and washable to increase filtering efficiency (see **Cleaning the Pre-Filter**, page 18).

B. H13 True HEPA Filter

- HEPASmart™ Technology uses statically charged fibers to capture viruses and bacteria with greater efficiency.
- Traps at least 99.97% of airborne particles 0.3 microns in size.
- Filters small particles such as fine dust, smoke particles, and allergens such as pollen and pet dander.

C. High-Efficiency Activated Carbon Filter

- Physically adsorbs smoke, odors, and fumes.
- Filters compounds such as formaldehyde, benzene, ammonia, hydrogen sulfide, and volatile organic compounds (VOCs).

COVID-19 Disclaimer

According to the CDC, portable HEPA filtration units that combine a HEPA filter with a powered fan system are effective at cleaning air within spaces to reduce the concentration of airborne particulates, including SARS-CoV-2 (COVID-19) viral particles.

Sources:

<https://www.cdc.gov/coronavirus/2019-ncov/community/ventilation.html#refphf>

<https://www.cdc.gov/mmwr/volumes/70/wr/mm7027e1.htm>

Note: *Levoit has not tested its air purifiers for effectiveness against SARS-CoV-2 and makes no claims that these air purifiers help reduce the spread of COVID-19.*

ABOUT THE FILTER (CONT.)

Clean Air Delivery Rate

This air purifier has a Clean Air Delivery Rate of 141 cubic feet per minute (CFM), or 240 m³/h.

Clean Air Delivery Rate (CADR) measures the efficiency of an air purifier by indicating the volume of clean air that an air purifier produces per minute. This is based on removal of dust, pollen, and smoke, which are the 3 most common indoor air pollutants. The higher the CADR, the more particles the air purifier will remove and the larger the area it can clean. The rating is measured at the air purifier's highest speed.

Air Change Per Hour

The air change rate is how many times all of the air in a room can be purified (or "changed") by the air purifier in 1 hour. Air changes per hour are calculated on the recommended room size assuming 8 ft / 2.4 m ceilings. For smaller rooms, the air change per hour will increase. This air purifier can change air 5 times per hour at the max speed in a single, closed room up to 219 ft² / 20 m². This is measured at ACH 5. The air purifier is effective for larger rooms, but air purification will take longer, with fewer air changes per hour. For example, the air purifier's effective range is 548 ft² / 50 m² based on 2 ACH, or purifying the air in the room 2 times per hour.

Note: To effectively clean air, keep windows and doors closed while the air purifier is on.

Humidity

Moisture may damage the filter. This air purifier should be used in an area with a humidity level 85% RH or below. If you use the air purifier in excessively humid areas, the surface of the filter may become moldy.

Note: Water or moisture will allow mold to grow. To solve a mold problem, get rid of the source of the moisture and clean up the mold.

Essential Oils



Do not add essential oils to the air purifier or filter. The filter will become damaged by the oil and will eventually release an unpleasant smell. **Do not** use diffusers near the air purifier.

CARE & MAINTENANCE

Cleaning the Smart Air Purifier

- Unplug before cleaning.
- Wipe the outside of the air purifier with a soft, dry cloth. If necessary, wipe the housing with a damp cloth, then immediately dry.
- Vacuum the inside of the air purifier.
- **Do not** clean with abrasive chemicals or flammable cleaning agents.

Check Filter Indicator





 will light up as a reminder to check the filter. Depending on how often you use the air purifier, the indicator should turn on after about 9 months. You may not need to change your filter yet, but you should check it when  lights up.

When your air purifier is set up with the VeSync app, you can also check the app to see the remaining filter life. You will also receive a notification from VeSync when it's time to check your filter.

Note: The VeSync app uses a scientific algorithm to determine your filter life based on air quality, amount of use, and other factors. The filter life percentage is based on 12 hours of daily use.

Resetting the Check Filter Indicator

Reset the Check Filter Indicator when:

-  lights up. This is the Check Filter Indicator light.
 - Replace the filter (see page 19).
 - Turn on the air purifier.
 - To reset the Check Filter Indicator, press and hold  for 3 seconds.
 - The Check Filter Indicator light will flash, and turn off when successfully reset. The filter life will show as 100% in the VeSync app.
- The filter was changed before  lit up.
 - After replacing the filter, turn on the air purifier.
 - To reset the Check Filter Indicator, press and hold  for 3 seconds.
 - The Check Filter Indicator will flash, and turn off when successfully reset. The filter life will show as 100% in the VeSync app.

CARE & MAINTENANCE (CONT.)

Cleaning the Pre-Filter

The Washable Pre-Filter should be cleaned every 2–4 weeks to increase efficiency and extend the life of your filter. You can set a reminder in the VeSync app to clean the pre-filter every 2, 3, or 4 weeks. Clean the pre-filter using a soft brush or vacuum hose to remove hair, dust, and large particles. Optionally, you can wash the pre-filter with water and a mild detergent to remove dirt and dust.

Note: Avoid scrubbing, scraping, or vigorously brushing the pre-filter. **Do not** use abrasive cleaning materials.

To wash the pre-filter:

1. Turn off the air purifier.
2. Open the front cover
3. Push the pre-filter's tabs inward and pull to remove the pre-filter.
4. Clean the surface of the pre-filter with a vacuum. *[Figure 2.1]*

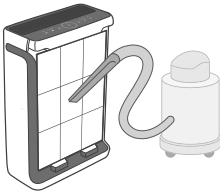

Figure 2.1

5. Rinse the pre-filter with water under a faucet.
6. Wash the pre-filter with mild detergent and a soft cloth. *[Figure 2.2]*



Figure 2.2

7. Allow the pre-filter to air-dry. Once completely dry, place the pre-filter back into the air purifier. *[Figure 2.3]*

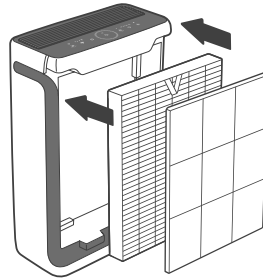

Figure 2.3

Filter	When to Clean	How to Clean	When to Replace
Washable Pre-Filter	Every 2–4 weeks	Use a soft cloth or vacuum hose	Does not need to be replaced
		Wash with water and mild detergent	
True HEPA / Activated Carbon Filter	Do not clean		9–12 months

CARE & MAINTENANCE (CONT.)

When Should I Replace the Filter?

The True HEPA / Activated Carbon Filter should be replaced every 9 months. You may need to replace your filter earlier or later depending on how often you use your air purifier. Using your air purifier in an environment with relatively high pollution may mean you will need to replace the filter more often, even if the Check Filter Indicator is off.

You may need to replace your filter if you notice:

- The air purifier does not effectively filter certain odors anymore
- Increased noise when the air purifier is on
- Decreased airflow from the top of the air purifier
- Unusual odors
- The HEPA filter is visibly dusty or discolored after removing the pre-filter

Note:

- *To maintain the performance of your air purifier, **only** use official Levoit filters. For more information, contact **Customer Support** (see page 26).*
- *Remember to reset the Check Filter Indicator after replacing the filter (see page 17).*

Replacing the Filter

1. Unplug the air purifier, then pull the front cover to remove it (see **Getting Started**, page 7).
2. Push the pre-filter's tabs inward and pull to remove the pre-filter.
3. Remove the old filter from the air purifier.
4. Clean out any remaining dust or hair inside the air purifier using a vacuum hose.

Note: *Do not use water or liquids to clean the air purifier.*

5. Remove the plastic packaging from the new filter and place the filter and pre-filter inside the air purifier (see **Getting Started**, page 7)
6. Replace the front cover.
7. Plug in and turn on the air purifier. Reset the Check Filter Indicator (see page 17).

CARE & MAINTENANCE (CONT.)

Cleaning the Dust Sensor

It is recommended to clean the AirSight™ Infrared Dust Sensor lens every 2 months to help maintain the efficiency of the sensor. If the Air Quality Indicator is red (indicating “Bad” air quality) more than usual, you may need to clean your dust sensor.

Note: How often you clean the dust sensor will depend on the air quality of your environment. If your air is often polluted with dust, dander, smoke, and other particles, you may need to clean your dust sensor more often.

1. Unplug the air purifier.
2. Open the dust sensor cover. [Figure 3.1]

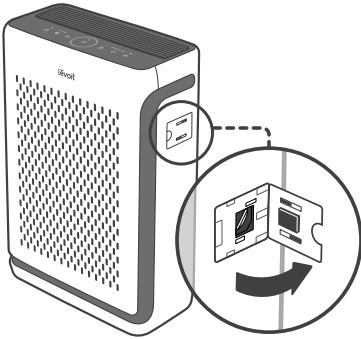

Figure 3.1

3. Use a cotton swab dipped in water to clean the dust sensor lens. [Figure 3.2]

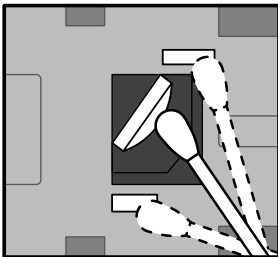

Figure 3.2

4. Wipe the lens dry with a dry cotton swab.
5. Replace the dust sensor cover.

Note: Do not remove the foam piece attached to the dust sensor cover unless instructed by Customer Support. [Figure 3.3]

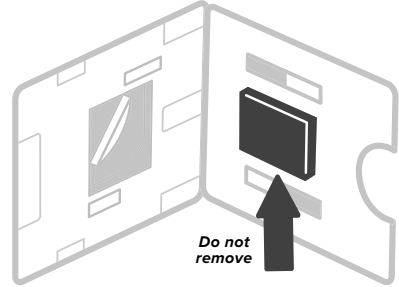



Figure 3.3







Storage

If not using the air purifier for an extended period of time, wrap both the air purifier and the filter in plastic packaging and store in a dry place to avoid moisture damage.

TROUBLESHOOTING

Problem	Possible Solution
<p>Air purifier will not turn on or respond to button controls.</p>	<p>Plug in the air purifier.</p>
	<p>Check to see if the power cord is damaged. If it is, stop using the air purifier and contact Customer Support (see page 26).</p>
	<p>Plug the air purifier into a different outlet.</p>
	<p>The air purifier may be malfunctioning. Contact Customer Support (see page 26).</p>
<p>Airflow is significantly reduced.</p>	<p>Make sure the filter is removed from its packaging and properly in place (see page 7).</p>
	<p>Tap  to increase the fan speed.</p>
	<p>Leave 15 inches / 38 cm of clearance from the front of the air purifier.</p>
	<p>The pre-filter may be clogged by large particles, such as hair or lint, blocking airflow. Clean the pre-filter (see page 18).</p>
	<p>Replace the filter (see page 19).</p>
<p>Air purifier makes an unusual noise while the fan is on.</p>	<p>Make sure the filter is properly in place with plastic packaging removed (see page 7).</p>
	<p>Make sure the air purifier is operating on a hard, flat, level surface.</p>
	<p>Replace the filter (see page 19).</p>
	<p>The air purifier may be damaged, or a foreign object may be inside. Stop using the air purifier and contact Customer Support (see page 26). Do not try to repair the air purifier.</p>
<p>Poor air purification quality.</p>	<p>Tap  to increase the fan speed.</p>
	<p>Make sure no objects are blocking the front, sides, or top of the air purifier (the inlet or outlet).</p>
	<p>Make sure the filter is removed from its packaging and properly in place (see page 7).</p>
	<p>Close doors and windows while using the air purifier.</p>
	<p>If the room is larger than 219 ft² / 20 m², air purification will take longer.</p>
	<p>Replace the filter (see page 19).</p>

TROUBLESHOOTING (CONT.)

Problem	Possible Solution
Strange smell coming from the air purifier.	Clean the filter, or replace if necessary.
	Contact Customer Support (see page 26).
	Make sure not to use your air purifier in an area with high humidity or while diffusing essential oils.
Air Quality Indicator always stays blue, even when the air quality is poor.	Clean the dust sensor lens (see page 20).
	The dust sensor detects airborne particles, but it cannot detect gas. Make sure there aren't gasses polluting the air.
Air Quality Indicator always stays red.	Clean the dust sensor lens (see page 20).
	If you're using an ultrasonic humidifier near the air purifier, the mist may affect the accuracy of the dust sensor. The dust sensor will detect the large mist particles, and the Air Quality Indicator may turn red. Avoid using an ultrasonic humidifier near the air purifier, or avoid using Auto Mode.
Air purifier randomly turns off.	Air purifier is malfunctioning. Stop using the air purifier and contact Customer Support (see page 26).
 is still on after replacing the filter.	Reset the Check Filter Indicator (see page 17).
 has not turned on after 9 months.	 is a reminder for you to check the filter and will light up based on how much the air purifier has been used, as well as other factors (see page 17). If you don't use your air purifier often,  will take longer to turn on.
 turned on before 9 months.	 is a reminder for you to check the filter and will light up based on how much the air purifier has been used, as well as other factors (see page 17). If you run your air purifier frequently,  will turn on sooner.

If your problem is not listed, please contact **Customer Support** (see page 26).

VESYNC APP TROUBLESHOOTING

My smart air purifier isn't connecting to the VeSync app.

- Make sure your phone has Bluetooth® turned on and is not currently connected to another Bluetooth device.
- During the setup process, you must be on a secure 2.4GHz Wi-Fi® network. Confirm that the network is working correctly.
- Make sure the Wi-Fi password you entered is correct.
 - There should be no spaces at the beginning or end of the password.
 - Test the password by connecting a different electronic device to the router.
 - If you're manually typing in the SSID and password, double check that both are entered correctly.
- Try moving your air purifier closer to the router. Your phone should be as close as possible to your air purifier.
- Your router may need to be at a higher location, away from obstructions.
- Make sure your air purifier and router are away from appliances (such as microwave ovens, refrigerators, electronic devices, etc.) to avoid signal interference.
- If you're using a VPN, make sure it's turned off while setting up your air purifier.
- Disable portal authentication for your Wi-Fi network. If portal authentication is enabled, the air purifier will not be able to access your Wi-Fi network, and setup will fail.

Note: *Portal authentication means that you need to sign in to your Wi-Fi network through a web page before you can use the Internet.*

My air purifier is offline.

- Make sure the air purifier is plugged in and has power, then refresh the VeSync menu by swiping down on the screen.
- Make sure your router is connected to the internet and your phone's network connection is working.
- Delete the offline air purifier from the VeSync app. Swipe left (iOS®) or press and hold (Android™), then tap **Delete**. Reconfigure the air purifier with the VeSync app.

Note: *Power outages, internet outages, or changing Wi-Fi routers may cause the air purifier to go offline.*

If your problem is not listed, please contact **Customer Support** (see page 26).

FEDERAL COMMUNICATION COMMISSION INTERFERENCE STATEMENT – PART 15

This device complies with Part 15 of the FCC Rules. Operation is subject to the following two conditions:

1. This device may not cause harmful interference, and
2. This device must accept any interference received, including interference that may cause undesired operation.

NOTE: This equipment has been tested and found to comply with the limits for a Class B digital device, pursuant to Part 15 of the FCC Rules. These limits are designed to provide reasonable protection against harmful interference in a residential installation. This equipment generates, uses and can radiate radio frequency energy and, if not installed and used in accordance with the instructions, may cause harmful interference to radio communications. However, there is no guarantee that interference will not occur in a particular installation. If this equipment does cause harmful interference to radio or television reception, which can be determined by turning the equipment off and on, the user is encouraged to try to correct the interference by one or more of the following measures:

- Reorient or relocate the receiving antenna.
- Increase the separation between the equipment and receiver.
- Connect the equipment into an outlet on a circuit different from that to which the receiver is connected.
- Consult the dealer or an experienced radio/TV technician for help.

FCC Caution: Any changes or modifications not expressly approved by the party responsible for compliance could void the user's authority to operate this equipment.

FCC RADIATION EXPOSURE STATEMENT

This equipment complies with FCC radiation exposure limits set forth for an uncontrolled environment. End users must follow the specific operating instructions for satisfying RF exposure compliance. To maintain compliance with FCC RF exposure compliance requirements, please follow operation instructions as documented in this manual. This transmitter must not be co-located or operating in conjunction with any other antenna or transmitter. This equipment should be installed and operated with a minimum distance of 20 cm between the radiator and your body. The availability of some specific channels and/or operational frequency bands are country dependent and are firmware programmed at the factory to match the intended destination. The firmware setting is not accessible by the end user.

FCC SDOC SUPPLIER'S DECLARATION OF CONFORMITY

Arovast Corporation hereby declares that this equipment is in compliance with the FCC requirements. The declaration of conformity may be consulted in the support section of our website, accessible from www.levoit.com

WARRANTY INFORMATION

Product Name	Vital 100S Smart True HEPA Air Purifier
Model	LAP-VI02S-WUS
Date of Purchase	
Order ID	

Terms & Policy

Arovast Corporation (“Arovast”) warrants this product to the original purchaser to be free from defects in material and workmanship, under normal use and conditions, for a period of 2 years from the date of original purchase.

Arovast agrees, at our option during the warranty period, to repair any defect in material or workmanship or furnish an equal product in exchange without charge, subject to verification of the defect or malfunction and proof of the date of purchase.

There is no other express warranty. This warranty does not apply:

- If the product has been modified from its original condition;
- If the product has not been used in accordance with directions and instructions in the user manual;
- To damages or defects caused by accident, abuse, misuse or improper or inadequate maintenance;
- To damages or defects caused by service or repair of the product performed by an unauthorized service provider or by anyone other than Arovast;
- To damages or defects occurring during commercial use, rental use, or any use for which the product is not intended;
- To damages or defects exceeding the cost of the product.

Arovast will not be liable for indirect, incidental, or consequential damages in connection with the use of the product covered by this warranty.

This warranty extends only to the original consumer purchaser of the product and is not transferable to any subsequent owner of the product regardless of whether the product is transferred during the specified term of the warranty.

This warranty does not extend to products purchased from unauthorized sellers. Arovast’s warranty extends only to products purchased from authorized sellers that are subject to Arovast’s quality controls and have agreed to follow its quality controls.

All implied warranties are limited to the period of this limited warranty.

This warranty gives you specific legal rights and you may also have other rights which vary from state to state. Some states do not allow the exclusion or limitation of incidental or consequential damages, so the above limitation or exclusion may not apply to you.

If you discover that your product is defective within the specified warranty period, please contact Customer Support via **support@levoit.com**. **DO NOT** dispose of your product before contacting us. Once our Customer Support Team has approved your request, please return the product with a copy of the invoice and order ID.

Every Levoit product automatically includes a 2-year warranty. To make the customer support process quick and easy, register your product online at www.levoit.com/warranty.

This warranty is made by:

Arovast Corporation
1202 N. Miller St., Suite A
Anaheim, CA 92806

CUSTOMER SUPPORT

If you have any questions or concerns about your new product, please contact our helpful Customer Support Team.

Distributed by Arovast Corporation

1202 N. Miller St., Suite A
Anaheim, CA 92806

Email: support@levoit.com

Toll-Free: (888) 726-8520

Support Hours

Mon–Fri, 9:00 am–5:00 pm PST/PDT

*Please have your order invoice and order ID ready before contacting Customer Support.



The energy efficiency of this ENERGY STAR certified model is measured based on a ratio between the model's CADR for Smoke and the electrical energy it consumes, or CADR/Watt.

ATTRIBUTIONS

Amazon, Alexa, and all related logos are trademarks of Amazon.com, Inc. or its affiliates.

Google, Android, and Google Play are trademarks of Google LLC.

App Store® is a trademark of Apple Inc.

Wi-Fi® is a registered trademark of Wi-Fi Alliance®.

iOS is a registered trademark of Cisco Systems, Inc. and/or its affiliates in the United States and certain other countries.

The Bluetooth® word mark and logos are registered trademarks owned by Bluetooth SIG, Inc. and any use of such marks by Arovast Corporation is under license. Other trademarks and trade names are those of their respective owners.



/LEVOIT



/LEVOIT



/LEVOITLIFESTYLE



/LEVOITLIFESTYLE



/LEVOITLIFESTYLE



LEVOIT.COM

lëvoit[®]