



USER MANUAL

VeSync Dual 200S Smart Top-Fill Humidifier

Model: Dual 200S



Questions or Concerns?

Please contact us Mon–Fri, 9:00 am–5:00 pm PST/PDT at support@levoit.com or at **(888) 726-8520**.

Table of Contents

Package Contents	2
Specifications	2
Safety Information	3
Getting to Know Your Smart Humidifier	5
Controls & Display	7
Getting Started	8
VeSync App Setup	11
Using Your Smart Humidifier	12
Care & Maintenance	15
Troubleshooting	20
VeSync App Troubleshooting	22
Warranty Information	24
Customer Support	25

Package Contents

- 1 × Smart Top-Fill Humidifier
- 2 × Water Filter Sponge (1 Pre-Installed)
- 1 × Cleaning Brush
- 1 × User Manual
- 1 × Quick Start Guide

Specifications

Power Supply	24V $\overline{\text{=}}$ 1A
Rated Power	24W
Water Tank Capacity	0.79 gal / 3 L
Max Run Time	Up to 25 hours on low mist setting Note: The humidifier may run for a longer or shorter time depending on the environmental temperature and humidity.
Noise Level	≤ 28dB
Effective Range	107–290 ft ² / 10–27 m ²
Dimensions	7.1 × 7.1 × 11.8 in / 18 × 18 × 30 cm
Weight	3 lb / 1.4 kg
Power Adapter	Input: 100-240V \sim 50/60Hz Output: 24V $\overline{\text{=}}$ 1A

Note: To access additional smart humidifier functions, download the free VeSync app (see page 1f).

READ AND SAVE THESE INSTRUCTIONS

SAFETY INFORMATION

To reduce the risk of fire, electric shock, or other injury, follow all instructions and safety guidelines.

General Safety

- **Only** use the humidifier as described in this manual.
- Place the humidifier and cord so that it will not be knocked over.
Do not place near large pieces of furniture or in high-traffic areas.
- When not in use, turn the humidifier off and disconnect from power by removing the plug from the outlet.
- **Do not** use the humidifier in wet environments.
- Keep the humidifier out of reach from children.
- **Do not** open the base or remove the water level sensor for self-servicing.
- **Always** unplug your humidifier from the power outlet before cleaning your humidifier or detaching the water tank from the humidifier base.
- **Always** make sure to place the humidifier on a flat, level surface before operation.
- **Only** fill the water tank with clean water. **Never** fill the water tank with any other liquids.
- **Do not** place the humidifier near sources of heat, such as stovetops, ovens, or radiators.
- **Do not** place the humidifier directly on floors, carpets, or rugs.
- **Do not** use other items as replacement parts for this product.
- **Do not** cover the nozzle while the humidifier is on. Doing so may damage the humidifier.
- Remove the water tank from the base before moving the humidifier.
- **Do not** immerse the humidifier base, power cord, or plug in water.
- If the humidifier is damaged or is not functioning properly, stop using it and contact **Customer Support** immediately (see page 25).
- This humidifier is not to be used by persons (including children) with reduced physical, sensory or mental capabilities, or lack of experience and knowledge, unless they have been given supervision or instruction concerning use of the appliance by a person responsible for their safety.
- Supervise children when they are near the humidifier.
- Children should not clean or perform maintenance on the humidifier without supervision.
- Children should be supervised to ensure that they do not play with the humidifier.
- Not for commercial use.
Household use **only**.

SAFETY INFORMATION (CONT.)

Caution: Risk of Leaks and Electric Shock

Do not add supplemental water treatment liquids into the water tank or base chamber. This will damage the humidifier and cause leaks.

Power & Cord

- Ensure that the plug fits properly into a polarized socket.
- **Do not** handle the power cord or plug with wet hands. Keep the plug and power cord away from liquids.
- Your humidifier has a polarized plug (one prong is wider than the other), which fits into a polarized outlet only one way. This is a safety feature to reduce the risk of electric shock. If the plug does not fit, reverse the plug. If it still does not fit, **do not** use the plug in that outlet. **Do not** bypass this safety feature.
- If the power supply cord is damaged, it must be replaced by Arovast Corporation or similarly qualified persons in order to avoid an electric or fire hazard. Please contact **Customer Support** (page 25).
- Unplugging the power cord will disable remote control of the humidifier and temporarily disconnect the humidifier from VeSync and other third-party apps.

GETTING TO KNOW YOUR SMART HUMIDIFIER

- A.** Nozzle
- B.** Water Tank Cover
- C.** Water Filter Housing
- D.** Water Filter
- E.** Mist Tube
- F.** Water Tank
- G.** Float
- H.** Base
- I.** Display
- J.** Cleaning Brush
- K.** Power Adapter
- L.** Max Water Line (Tank)
- M.** Water Outlet Valve
- N.** Noise Silencer
- O.** Air Outlet
- P.** Max Water Line (Base)
- Q.** Float Brackets
- R.** Transducer
- S.** Secondary Float
- T.** Humidity Sensor
- U.** Feet
- V.** Power Adapter Input
- W.** Air Inlet

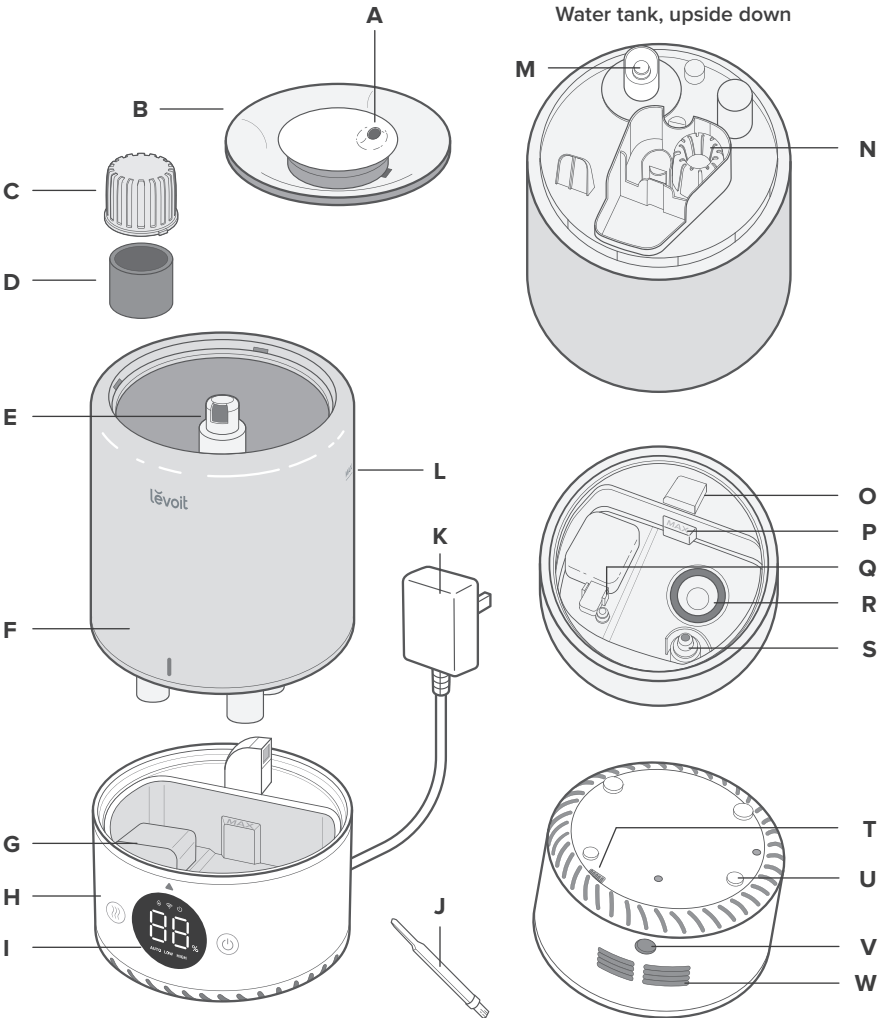

Getting To Know Your Smart Humidifier (cont.)

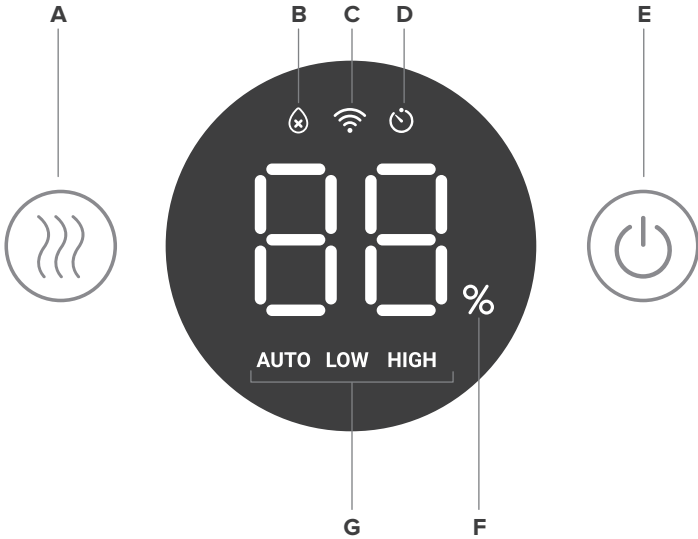

- A. Mist Level Button
- B. No Water Indicator
- C. Wi-Fi® Indicator

- D. Timer Indicator
Note: *The timer must be set in the VeSync app.*

- E. Power Button
- F. Humidity Level Indicator
- G. Mist Level Indicator

CONTROLS & DISPLAY

Note: You can also control these functions using the VeSync app, as well as additional functions (see page 13).



Power Button

- Press to turn the humidifier on/off.
- Press and hold for 5 seconds to pair with the VeSync app. See the VeSync in-app instructions for more information.
- Press and hold for 15 seconds to reset the humidifier. This will restore the humidifier's default settings and disconnect it from Wi-Fi® and the VeSync app (see page 11).



Mist Level Button

- Press repeatedly to cycle through mist level settings: Low, High, and Auto Mode. (For more details on Auto Mode, see page 13.)
- Press and hold for 3 seconds to turn off the humidifier display.



Wi-Fi Indicator

- Turns on, off, or blinks to indicate pairing status. See the VeSync in-app instructions for more information.



No Water Indicator

- Blinks when there is no water in the tank. After this indicator blinks 10 times, the humidifier will turn off. Refill the tank and properly place it on the base to use your humidifier.
- Lights up when the water tank is removed. Remains on until the tank is replaced.

GETTING STARTED

1. Remove all packaging.
2. Take the water tank off of the base and **remove all tape**, including any tape on the float. [Figure 1.1]

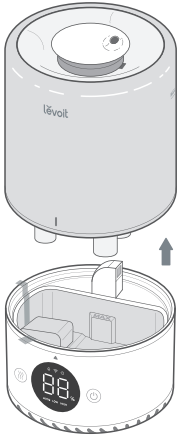

Figure 1.1

3. Rinse and reassemble all parts before first use (see **Cleaning**, page 15).

Note:

- Check to make sure that the water filter is correctly in place. If not, then rotate the filter clockwise to secure it in place. [Figure 1.2]

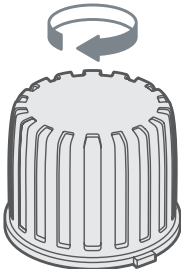

Figure 1.2

- Check to make sure that the float is securely in place. [Figure 1.3]

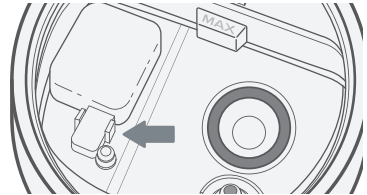

Figure 1.3

4. Choose a hard, flat location for the humidifier at least 12 inches / 30 cm away from any walls. The surface must be water-resistant. [Figure 1.4]

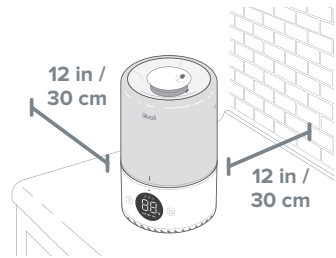

Figure 1.4

5. Mist should be directed away from walls, furniture, bedding, and appliances. [Figure 1.5]

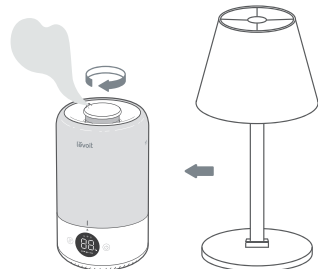

Figure 1.5

Filling & Refilling

Note: Make sure the water tank is clean before filling.

1. Remove the water tank cover by holding the nozzle and pulling upward. [Figure 1.6]

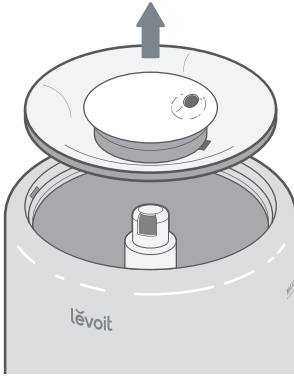

Figure 1.6

2. Fill the tank with room-temperature water. [Figure 1.7] **Do not** fill with hot water.

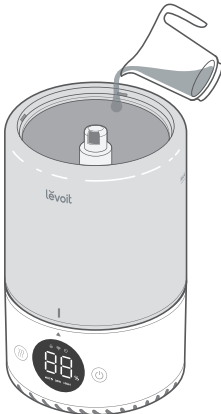

Figure 1.7

Note:

- We recommend using purified or distilled water to fill the tank.
- **Do not** fill past the tank's max water line.

CAUTION

- **Do not** add water directly into the base chamber. [Figure 1.8]

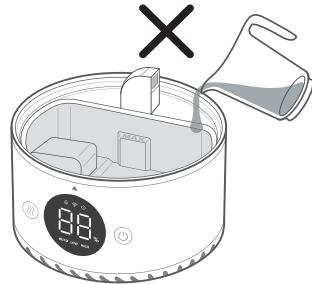

Figure 1.8

- **Do not** add water through the mist tube. [Figure 1.9]

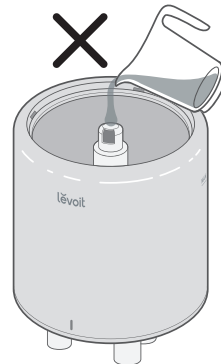

Figure 1.9

Filling & Refilling (cont.)

3. Replace the water tank cover.

Note: Make sure the nozzle on the water tank cover is placed over the mist tube, or the humidifier may not work correctly. [Figure 1.10]

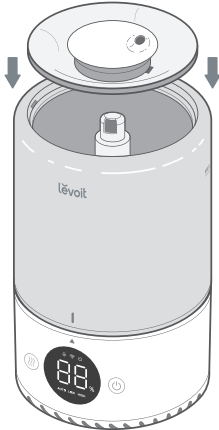

Figure 1.10

4. Optionally, add 10–15 drops of essential oil into the base chamber for aromatherapy. [Figure 1.11]

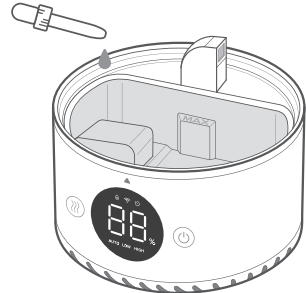

Figure 1.11

Note: For best results, we recommend using pure essential oil.

VESYNC APP SETUP

Note: Due to ongoing updates and improvements, the VeSync app may be slightly different than shown in the manual. In case of any differences, follow the in-app instructions.

1. To download the VeSync app, scan the QR code or search “VeSync” in the Apple App Store® or Google Play Store. [Figure 2.1]

Note: For Android™ users, choose “Allow” to use VeSync.

2. Open the VeSync app. If you already have an account, tap **Log In**. To create a new account, tap **Sign Up**.

Note: You must create your own VeSync account to use third-party services and products. These will not work with a guest account. With a VeSync account, you can also allow your family and friends to control your smart humidifier.

3. Follow the in-app instructions to set up your smart humidifier.

Note:

- You can use the VeSync app to connect your smart humidifier to Amazon Alexa or Google Assistant™. Follow the in-app instructions to connect VeSync to your voice assistant.
- Your phone must have Location turned on while your phone is connecting to your smart humidifier. This is required to establish the Bluetooth® connection. You can turn Location off after your smart humidifier is finished connecting to the VeSync app.

Wi-Fi Connection:



- To disconnect Wi-Fi, press and hold  for 15 seconds until the Wi-Fi indicator turns off. This will restore the smart humidifier’s default settings and disconnect it from the VeSync app.
- To reconnect, please follow the instructions in the VeSync app for adding a device.





Figure 2.1

USING YOUR SMART HUMIDIFIER

Note: Using the VeSync app allows you to control your smart humidifier remotely and access additional functions and features (see page 13).

1. Plug in the humidifier. Press  to turn your humidifier on. The humidifier will automatically begin misting on high for 3 seconds, then change to the low mist setting.

Note: If there is no water in the tank,  will flash 10 times, and the humidifier will turn off. Fill the water tank (see **Getting Started**, page 8).

2. Tap  repeatedly to cycle through mist settings: Auto Mode, Low, and High. [Figure 3.1]

Note:



- The humidifier will not mist in Auto Mode if the humidity level is above 50%. If you want the humidifier to keep misting, change the mist setting, or change the Auto Mode settings in the VeSync app.
- For more information about Auto Mode, see page 13.

3. Rotate the nozzle to adjust the direction of the mist. [Figure 3.2]
4. When your room has reached your preferred humidity level, turn the humidifier to a lower setting, or turn it off. A healthy humidity level is between 40% and 50%. [Figure 3.3]

Note: You can also use Auto Mode to keep the humidity level between 40% and 50%.

5. Press  to turn your humidifier off.

Note:

- If there is no water in the tank, the humidifier will stop misting,  will flash 10 times, and the humidifier will turn off. Refill the tank and properly place it on the base to use your humidifier.
- If the water tank is removed,  will remain on until the tank is replaced.

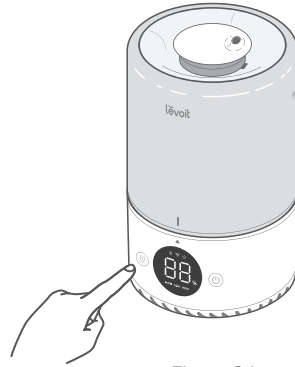

Figure 3.1

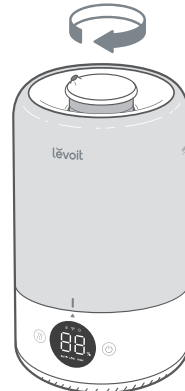

Figure 3.2



Figure 3.3

Auto Mode

Auto Mode uses the humidifier's sensor to automatically adjust the mist level (or turn it off) to maintain a comfortable and healthy level of humidity.

- Auto Mode automatically adjusts the mist level to maintain 40–50% relative humidity. You can change the target humidity level in the VeSync app.
- By default, Auto Mode uses Automatic Stop. The humidifier will stop misting when the highest target humidity level is reached. If the humidity drops below the target humidity level, the humidifier will begin misting again.
 - If Auto Mode is selected when the humidity is higher than the target humidity range, the humidifier will not start misting until the humidity lowers.
- In the VeSync app, you can turn Automatic Stop on/off. If Automatic Stop is off, the humidifier will keep running on Low mist level when the highest target humidity level is reached.

VeSync App Functions

The VeSync app allows you to access additional smart functions, including those listed below.

Remote Control

- Turn the humidifier on/off from your phone.
- Cycle through mist levels and turn on/off Auto Mode from your phone.
- Turn the display lights on/off from your phone.
- Customize Auto Mode settings like target humidity and auto-off.

Monitor Humidity Levels

- Check current humidity levels in the humidifier's environment.

Set Timers & Schedules

- Program individual timers or create a schedule for your smart humidifier.

Third-Party Voice Control

- Compatible with Amazon Alexa and Google Assistant™ for voice commands.

Note: *The VeSync app is continually updated and app features will expand.*

Important Tips

Your humidifier must have the correct level of water in the base chamber to work properly. If there is too much water in the base chamber, the humidifier cannot create mist.

- **Never** pour water directly into the base chamber. *[Figure 3.4]* **Only** add water to the water tank. The humidifier will automatically release the correct amount of water into the base chamber.
- Avoid moving or shaking the humidifier. *[Figure 3.5]* This may cause the water tank to release too much water into the base chamber.
- Before moving the humidifier, turn it off, unplug it, and remove the water tank.
- If your humidifier doesn't produce mist correctly, check the max water line to see if there is too much water in the base chamber. Pour out extra water if water is over the max line. *[Figure 3.6]*

Note: The max water line is **only** for this purpose.
Do not pour water into the base chamber.

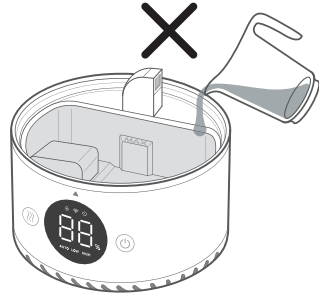

Figure 3.4



Figure 3.5

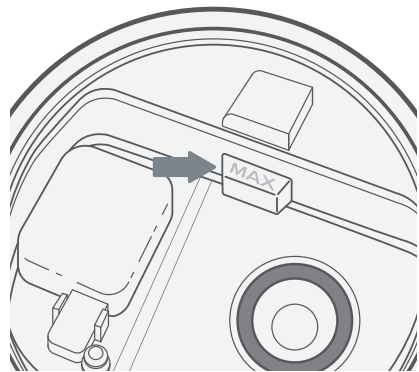

Figure 3.6

CARE & MAINTENANCE

Note:

- All maintenance should be done on a water-resistant surface, such as a kitchen counter.
- Change the water daily to avoid bacteria growth.
- Use a tissue or cloth to clean the nozzle regularly.
- If not using the humidifier for 1 week or longer, **do not** leave water inside. Clean and dry the humidifier instead.

Cleaning

You should clean your humidifier water tank and base chamber every week, and when you're ready to store it.

Note:

- **Never** immerse the base in water or liquid.
- **Do not** use detergents to clean the humidifier.
- The water tank, water tank cover, water filter housing, nozzle, float, and silencer are dishwasher safe.
- **Do not** put the water filter in the dishwasher or it may become discolored.

1. Unplug the humidifier.
2. Remove and rinse the water tank cover. [Figure 4.1]

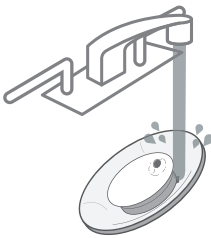

Figure 4.1

3. Remove the water tank from the base and pour out any water from the tank and base chamber. [Figure 4.2]

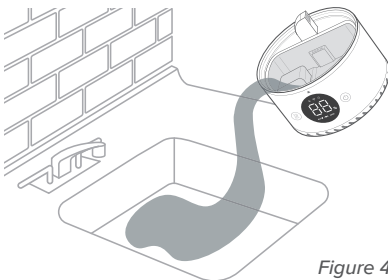

Figure 4.2

Note: When pouring out water, hold down the float to ensure that it does not fall out of the base chamber.

4. Remove the water filter assembly from the tank by rotating it counterclockwise and lifting it out. [Figure 4.3]

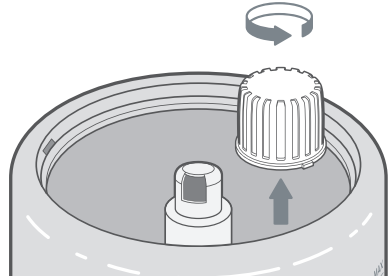

Figure 4.3

5. Rinse the tank, water filter assembly, and base chamber with room temperature water. [Figure 4.4]

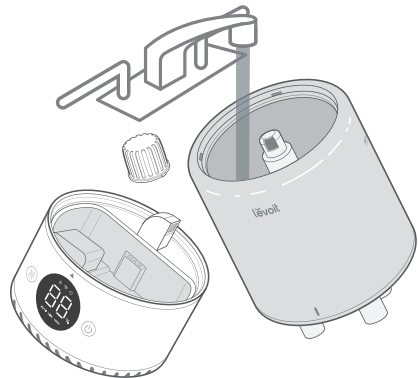

Figure 4.4

Cleaning (cont.)

6. To descale the humidifier:
- Remove the water filter from the tank. [Figure 4.5] Fill the tank with 3 US cups / 710 mL of distilled white vinegar. [Figure 4.6]

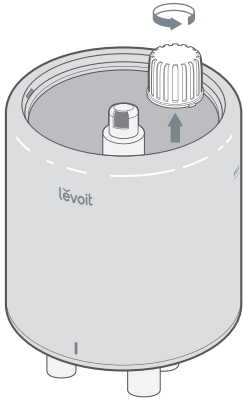

Figure 4.5

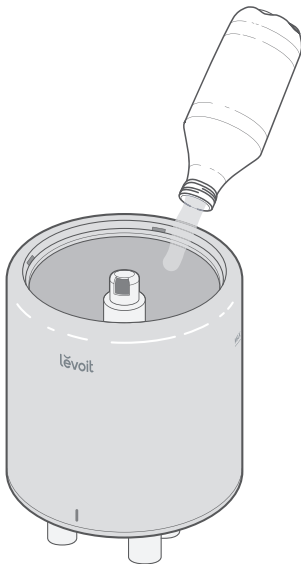

Figure 4.6

- Replace the tank cover and swish the vinegar around the tank. [Figure 4.7]

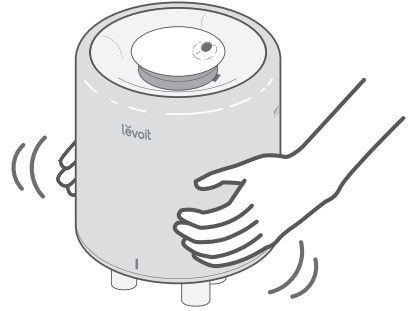

Figure 4.7

- Place the tank on the base and soak for 15–20 minutes. Vinegar will drain into the base chamber and loosen scale (mineral buildup) in the tank and in the base chamber (including the transducer and float). [Figure 4.8]

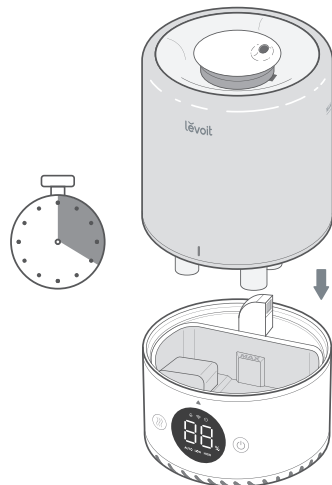

Figure 4.8

Cleaning (cont.)

- d. Remove the tank, remove the tank cover, and pour out any vinegar. [Figure 4.9]

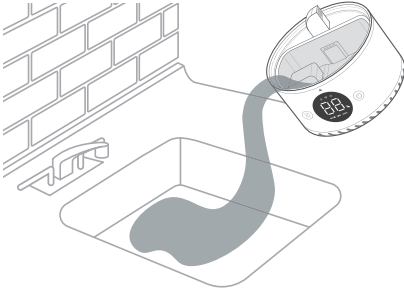

Figure 4.9

- e. Flip the tank over and remove the noise silencer. To remove the noise silencer, press the release tabs and gently pull away from the humidifier. [Figure 4.10]

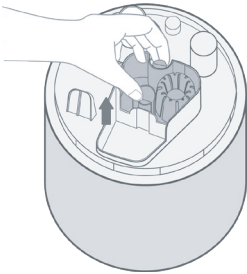

Figure 4.10

- f. Remove the float from the base chamber by pulling up one end of the float [Figure 4.11] and pulling the shaft out from the float brackets. One side of the float brackets is open (U-shaped) to allow the shaft to be removed. [Figure 4.12]

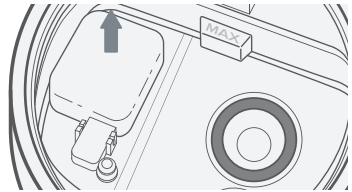

Figure 4.11

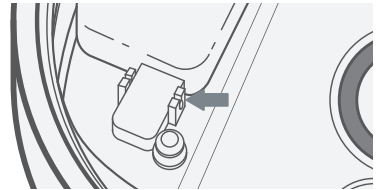

Figure 4.12

- g. Place the float, water filter assembly, and noise silencer in a small container. Fill with enough vinegar to cover them. Soak for 15–20 minutes. [Figure 4.13]

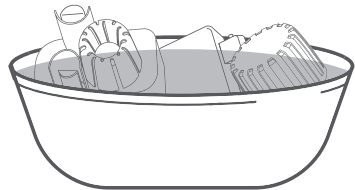

Figure 4.13

Cleaning (cont.)

- h. Use a soft cloth and the included cleaning brush to remove scale from all parts. [Figure 4.14]

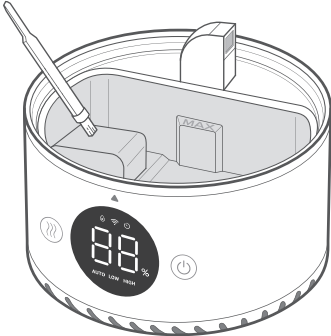

Figure 4.14

- i. Rinse all parts until any vinegar smell is completely gone. [Figure 4.15]

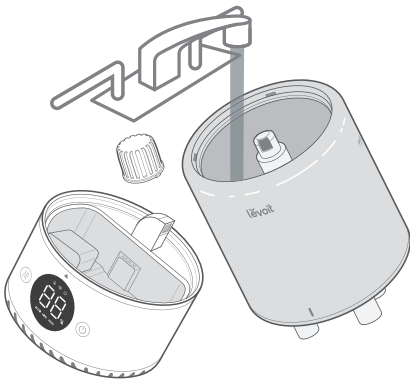

Figure 4.15

7. Dry all parts with a cloth. Make sure all parts are completely dry before reassembling or storing.

Reassembling

1. Flip the water tank over and place the noise silencer back into the tank. [Figure 4.16]

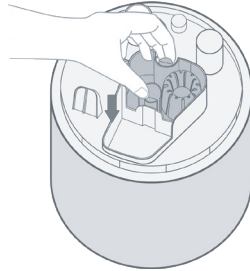

Figure 4.16

2. Place the water filter assembly back into the tank and rotate it clockwise to secure it in place. [Figure 4.17]

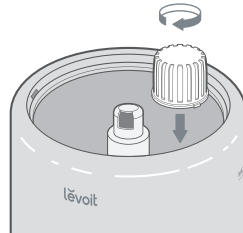

Figure 4.17

Reassembling (cont.)

3. Place the float back into the base chamber:
 - a. Make sure the correct side of the float is facing up. *[Figure 4.18]*

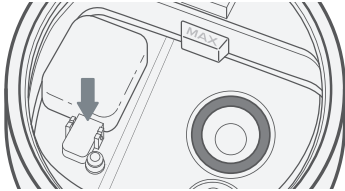

Figure 4.18

- b. Insert the smaller prong into the closed side of the float brackets. *[Figure 4.19]*

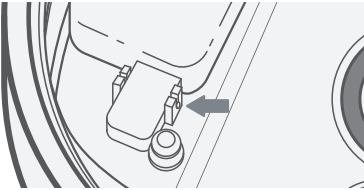

Figure 4.19

- c. Place the larger prong into the open (U-shaped) side of the float brackets.
4. Place the tank back on the base. Refill the tank, if necessary.
5. Place the tank properly on the base and place the tank cover on the water tank.

Storing

Follow the cleaning instructions (see page 15) and allow all parts to dry completely before storing. Store in a cool, dry location.

Replacing the Filter Assembly

If the filter assembly is damaged or water cannot flow into the base chamber, the filter or filter assembly needs to be replaced. For more information, contact **Customer Support** (see page 25).

TROUBLESHOOTING

Problem	Possible Solution
Humidifier doesn't turn on, or turns off unexpectedly.	Plug in the humidifier and turn it on.
	Add purified or distilled water to the water tank.
	Check to see if the humidifier is in Auto Mode. Depending on Auto Mode settings, the humidifier may automatically turn off when the humidity level is above the target level.
Little or no mist comes out.	Turn the mist level to a higher setting.
	Fill the water tank.
	There may be too much water in the base chamber. Empty the base chamber. Refill the water tank (not the base chamber) and place the water tank properly onto the base.
	Make sure the air inlet on the bottom of the base is not blocked. The humidifier should not be set on carpet or other surfaces that may block the air inlet.
	Make sure the nozzle is not blocked or clogged.
	Make sure the humidifier is on a level surface.
	The water temperature may be too low. Turn the mist level to the highest setting and let the humidifier run for a while, then adjust to the desired setting.
	If the water tank or base was washed with detergent, rinse thoroughly with clean water to remove any detergent.
Humidifier uses water too quickly.	Clean the water filter assembly (see page 15) or replace it with a new one (see page 25).
	The humidifier uses up water based on the environmental temperature and humidity. If your environment is cold and/or dry, the humidifier will run out of water faster.
Humidifier produces an unusual smell.	If the humidifier is new, unplug and rinse all parts, then place in a cool, dry place for 12 hours.
	If essential oils were diffused, clean all parts with white vinegar (follow the descaling instructions on page 16), and allow the humidifier to dry.
	Clean the water tank and base chamber (see Care & Maintenance , page 15).
White dust appears around the humidifier.	We recommend using purified or distilled water to fill the humidifier. Avoid using water with high mineral content.
	Clean the humidifier (see Care & Maintenance , page 15).

TROUBLESHOOTING (CONT.)

Problem	Possible Solution
Humidifier makes a loud or unusual noise.	Make sure the water tank is properly in place (see Getting Started , page 8).
	Set mist level to a lower setting.
	Empty the base chamber. Refill the water tank (not the base chamber) and place the water tank properly onto the base.
	The humidifier may be malfunctioning. Stop using the humidifier and contact Customer Support (see page 25).
Water leaks from the humidifier.	Make sure the silicone sealing ring around the water outlet valve is secure.
	Avoid running the humidifier in a room with over 60% relative humidity.
	Wipe any excess water off the top and bottom of the base.
	Do not shake the humidifier.
	Make sure to place the humidifier on a flat, level surface.
	Check the water tank for leaks. If there are leaks, contact Customer Support (see page 25).
Condensation forms around humidifier or windows.	Humidity may be too high. Turn down the mist level, turn off the humidifier, or open a door or window to the room.
Mold grows inside the humidifier.	Clean the water tank and base chamber regularly (see Care & Maintenance , page 15).
 is red.	Fill the water tank.
	Place the water tank properly on the base.
	Clean the water filter (see page 15) or replace it with a new one. To request a new water filter, contact Customer Support (see page 25).
Essential oil has little or no smell.	Make sure you've added 10–15 drops of oil into the base chamber. For best results, use pure essential oil.
Display shows an incorrect humidity percentage.	The room may be larger than the humidifier's effective range. Move to a room smaller than 107–290 ft ² / 10–27 m ² .
	Moisture may have built up inside the humidity sensor. Turn off the humidifier and allow the sensor to air dry. Make sure the nozzle is facing away from the sensor so that mist does not settle on the sensor (see diagram in Getting To Know Your Smart Humidifier , page 5).
Display shows Error Code "E1".	The humidifier is malfunctioning. Contact Customer Support (see page 25).

If your problem is not listed, please contact **Customer Support** (see page 25).

VESYNC APP TROUBLESHOOTING

Why isn't my humidifier connecting to the VeSync app?

- Make sure your phone has Bluetooth® turned on and is not currently connected to another Bluetooth device.
- During the setup process, you must be on a secure 2.4GHz Wi-Fi network. Confirm that the network is working correctly.
- During the setup process, your phone must have Location turned on. This is required to establish the Bluetooth® connection and allow your phone to connect to your humidifier. You can turn Location off after your smart humidifier is finished connecting to the VeSync app.
- Make sure the Wi-Fi password you entered is correct.
- Make sure your humidifier and phone are within 30 ft / 10 m of each other.
- Reset the humidifier by pressing and holding  for 15 seconds. Then try connecting again.

My humidifier is offline.

- Make sure the humidifier is plugged in. The humidifier may appear to be offline if it is unplugged, or if the outlet does not have power.
- Refresh the VeSync menu by swiping down on the screen.
- Make sure your router is connected to the internet and your phone's network connection is working.
- Reset the humidifier using one of these options:
 - a. Delete the humidifier from the VeSync app. Swipe left (iOS®) or press and hold (Android), then tap **Delete**. Then reconfigure your humidifier with the VeSync app.
 - b. Press and hold  for 15 seconds. Then reconfigure your humidifier with the VeSync app.

Note: Power outages, internet outages, or changing Wi-Fi routers may cause your humidifier to go offline.

The VeSync app is displaying an incorrect humidity percentage while the humidifier is turned on.

- The room may be larger than the humidifier's effective range. Move to a room smaller than 290 ft² / 27 m².
- Moisture may have built up inside the humidity sensor. Turn off the humidifier and allow the sensor to air dry. Make sure the nozzle is facing away from the sensor so that mist does not settle on the sensor (see diagram in **Getting To Know Your Smart Humidifier**, page 5).

If your problem is not listed, please contact **Customer Support** (see page 26).

FEDERAL COMMUNICATION COMMISSION INTERFERENCE STATEMENT - PART 15

This device complies with Part 15 of the FCC Rules. Operation is subject to the following two conditions:

1. This device may not cause harmful interference, and
2. This device must accept any interference received, including interference that may cause undesired operation.

NOTE: This equipment has been tested and found to comply with the limits for a Class B digital device, pursuant to Part 15 of the FCC Rules. These limits are designed to provide reasonable protection against harmful interference in a residential installation. This equipment generates, uses and can radiate radio frequency energy and, if not installed and used in accordance with the instructions, may cause harmful interference to radio communications. However, there is no guarantee that interference will not occur in a particular installation. If this equipment does cause harmful interference to radio or television reception, which can be determined by turning the equipment off and on, the users is encouraged to try to correct the interference by one or more of the following measures:

- Reorient or relocate the receiving antenna.
- Increase the separation between the equipment and receiver.
- Connect the equipment into an outlet on a circuit different from that to which the receiver is connected.
- Consult the dealer or an experienced radio/TV technician for help.

FCC Caution: Any changes or modifications not expressly approved by the party responsible for compliance could void the user's authority to operate this equipment.

FCC RADIATION EXPOSURE STATEMENT

This equipment complies with FCC radiation exposure limits set forth for an uncontrolled environment. End users must follow the specific operating instructions for satisfying RF exposure compliance. To maintain compliance with FCC RF exposure compliance requirements, please follow operation instructions as documented in this manual. This transmitter must not be co-located or operating in conjunction with any other antenna or transmitter. This equipment should be installed and operated with a minimum distance of 20 cm between the radiator and your body. The availability of some specific channels and/or operational frequency bands are country dependent and are firmware programmed at the factory to match the intended destination. The firmware setting is not accessible by the end user.

FEDERAL COMMUNICATION COMMISSION INTERFERENCE STATEMENT - PART 18

This device complies with Part 18 of the FCC Rules.

This equipment generates and uses ISM frequency energy and if not installed and used properly, that is in strict accordance with the manufacturer's instructions, may cause interference to radio and television reception. It has been type tested and found to comply with limits for an ISM Equipment pursuant to part 18 of FCC Rules, which are designed to provide reasonable protection against such interference in a residential installation. However, there is no guarantee that interference will not occur in a particular installation. If this equipment does cause interference to radio or television reception, which can be determined by tuning the equipment off and on, the user is encouraged to try to correct the interference by one or more of the following:

- Reorient the receiving antenna of radio or television.
- Relocate the equipment with respect to the receiver.
- Move the equipment away from receiver.
- Plug the equipment into a different outlet so that the equipment and receiver are on different branch circuits.

Conduct only the user maintenance found in this manual. Other maintenance and servicing can cause harmful interference and can void the required FCC compliance. The manufacturer is not responsible for any radio or TV interference cause by unauthorized modification to the equipment. It is the responsibility of the user to correct such interference.

FCC SDOC SUPPLIER'S DECLARATION OF CONFORMITY

Arovast Corporation hereby declares that this equipment is in compliance with the FCC Part 18 Subpart B. The declaration of conformity may be consulted in the support section of our website, accessible from www.levoit.com

WARRANTY INFORMATION

Product	Smart Top-Fill Humidifier
Model	Dual 200S
<i>For your own reference, we strongly recommend that you record your order ID and date of purchase.</i>	
Date of Purchase	
Order ID	

Terms & Policy

Arovast Corporation (“Arovast”) warrants this product to the original purchaser to be free from defects in material and workmanship, under normal use and conditions, for a period of 2 years from the date of original purchase.

Arovast agrees, at our option during the warranty period, to repair any defect in material or workmanship or furnish an equal product in exchange without charge, subject to verification of the defect or malfunction and proof of the date of purchase.

There is no other express warranty. This warranty does not apply:

- If the product has been modified from its original condition;
- If the product has not been used in accordance with directions and instructions in the user manual;
- To damages or defects caused by accident, abuse, misuse or improper or inadequate maintenance;
- To damages or defects caused by service or repair of the product performed by an unauthorized service provider or by anyone other than Arovast;
- To damages or defects occurring during commercial use, rental use, or any use for which the product is not intended;
- To damages or defects exceeding the cost of the product.

Arovast will not be liable for indirect, incidental, or consequential damages in connection with the use of the product covered by this warranty.

This warranty extends only to the original consumer purchaser of the product and is not transferable to any subsequent owner of the product regardless of whether the product is transferred during the specified term of the warranty.

This warranty does not extend to products purchased from unauthorized sellers. Arovast’s warranty extends only to products purchased from authorized sellers that are subject to Arovast’s quality controls and have agreed to follow its quality controls.

All implied warranties are limited to the period of this limited warranty.

This warranty gives you specific legal rights and you may also have other rights which vary from state to state. Some states do not allow the exclusion or limitation of incidental or consequential damages, so the above limitation or exclusion may not apply to you.

If you discover that your product is defective within the specified warranty period, please contact Customer Support via support@levoit.com. **DO NOT** dispose of your product before contacting us. Once our Customer Support Team has approved your request, please return the product with a copy of the invoice and order ID.

Every Levoit product automatically includes a **2-year warranty**. To make the customer support process quick and easy, register your product online at www.levoit.com/warranty.

This warranty is made by:

Arovast Corporation
1202 N. Miller St., Suite A
Anaheim, CA 92806

CUSTOMER SUPPORT

If you have any questions or concerns about your new product, please contact our helpful Customer Support Team.

Distributed by Arovast Corporation

1202 N. Miller St., Suite A
Anaheim, CA 92806

Email: support@levoit.com

Toll-Free: (888) 726-8520

Support Hours

Mon–Fri, 9:00 am–5:00 pm PST/PDT

*Please have your order invoice and order ID ready before contacting Customer Support.

ATTRIBUTIONS

Apple App Store is a trademark of Apple Inc.

Google, Android, and Google Play are trademarks of Google LLC.

Wi-Fi® is a registered trademark of Wi-Fi Alliance®.

Amazon, Alexa and all related logos are trademarks of Amazon.com, Inc. or its affiliates.

iOS is a registered trademark of Cisco Systems, Inc. and/or its affiliates in the United States and certain other countries.

The Bluetooth® word mark and logos are registered trademarks owned by Bluetooth SIG, Inc. and any use of such marks by Arovast Corporation is under license. Other trademarks and trade names are those of their respective owners.

lěvoit[®]



/LEVOITLIFESTYLE



/LEVOIT



/LEVOIT



/LEVOIT



LEVOIT.COM