

**KDE700XF-505 KDE DIRECT XF BRUSHLESS MOTOR, GEN3
PRODUCTION RELEASE**

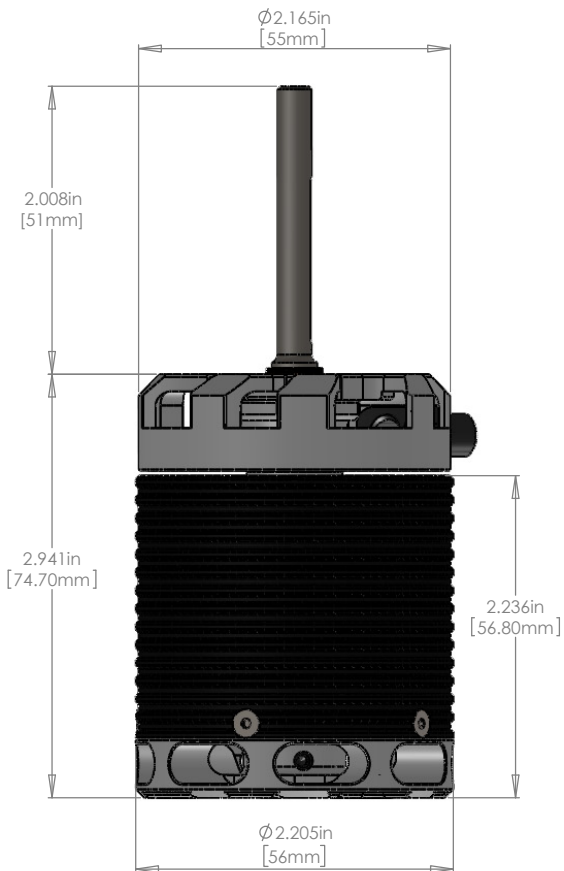
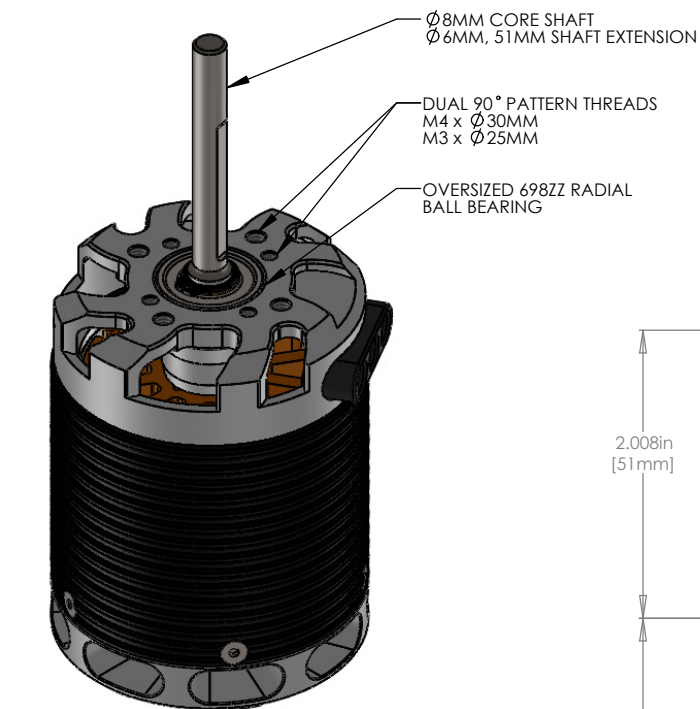

KDE DIRECT XF BRUSHLESS MOTOR SPECS.

\varnothing 8mm Core Shaft
 \varnothing 6mm, 51mm Extended Length
 - Shaft Flush with Centrifugal Fan Surface

698ZZ Upper Bearing (\varnothing 8mm x \varnothing 19mm x 6mm)
 MR148ZZ Lower Bearings (\varnothing 8mm x \varnothing 14mm x 4mm)
 - Triple Lower Bearings

Dual 90° Pattern Threads:
 M4 Threads x \varnothing 30mm Spacing
 M3 Threads x \varnothing 25mm Spacing

150mm Exit Lead Extensions (10 AWG)
 \varnothing 6.5mm 24K Bullets, Pre-Soldered and Shrink Wrap

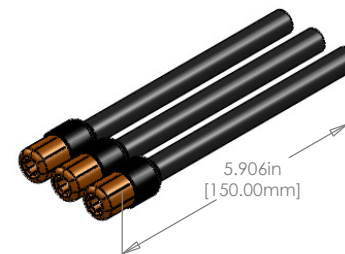

150.0MM EXIT LEAD EXTENSIONS (10 AWG)
 \varnothing 6.5MM MALE BULLETS PRE-SOLDERED



www.KDEDirect.com
KDE700XF-505-G3