

**KDE500XF-1350 KDE DIRECT XF BRUSHLESS MOTOR, GEN3  
PRODUCTION RELEASE**

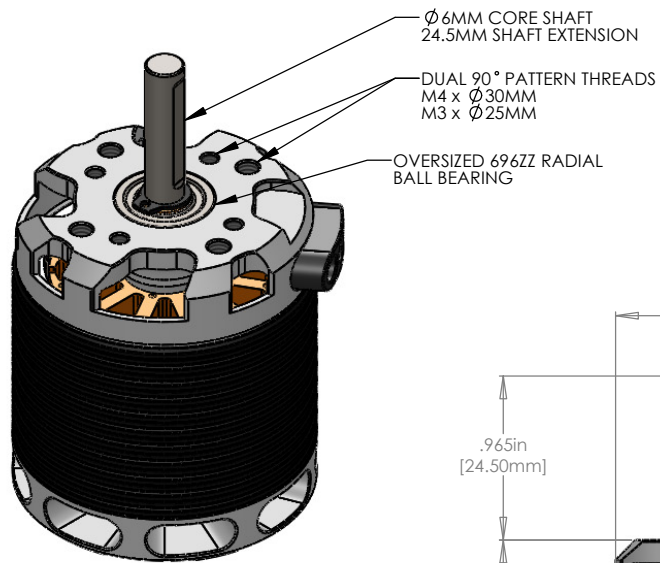

**KDE DIRECT XF BRUSHLESS MOTOR SPECS.**

$\phi$ 6mm Core Shaft  
 $\phi$ 6mm, 24.5mm Extended Length  
 - Shaft Flush with Centrifugal Fan Surface

696ZZ Upper Bearing ( $\phi$ 6mm x  $\phi$ 15mm x 5mm)  
 MR106ZZ Lower Bearings ( $\phi$ 6mm x  $\phi$ 10mm x 3mm)  
 - Triple Lower Bearings

Dual 90° Pattern Threads:  
 M4 Threads x  $\phi$ 30mm Spacing  
 M3 Threads x  $\phi$ 25mm Spacing

150mm Exit Lead Extensions (13 AWG)  
 $\phi$ 6.5mm 24K Bullets, Pre-Soldered and Shrink Wrap

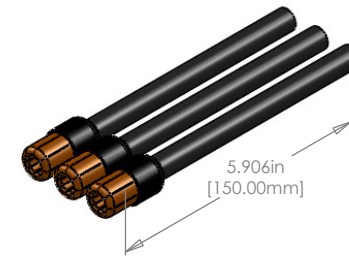

150.0MM EXIT LEAD EXTENSIONS (13 AWG)  
 $\phi$ 6.5MM MALE BULLETS PRE-SOLDERED



[www.KDEDirect.com](http://www.KDEDirect.com)  
**KDE500XF-1350-G3**