

**KDE3510XF-475 KDE DIRECT UAS BRUSHLESS MOTOR  
PRODUCTION RELEASE**

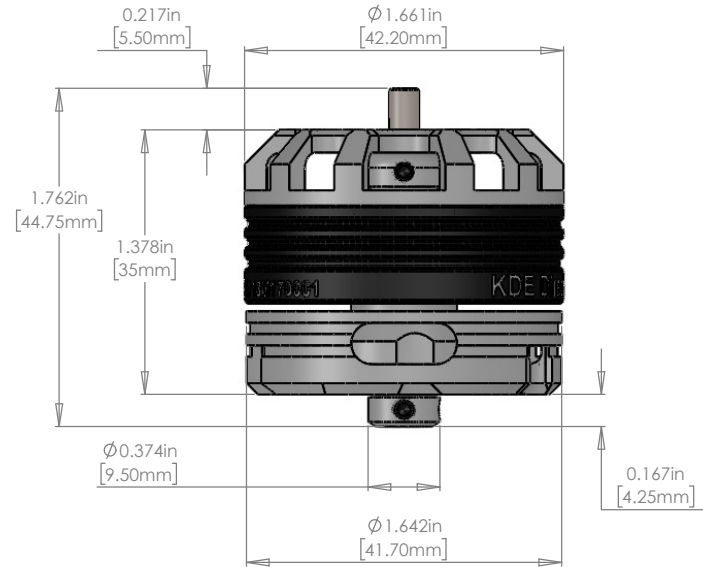
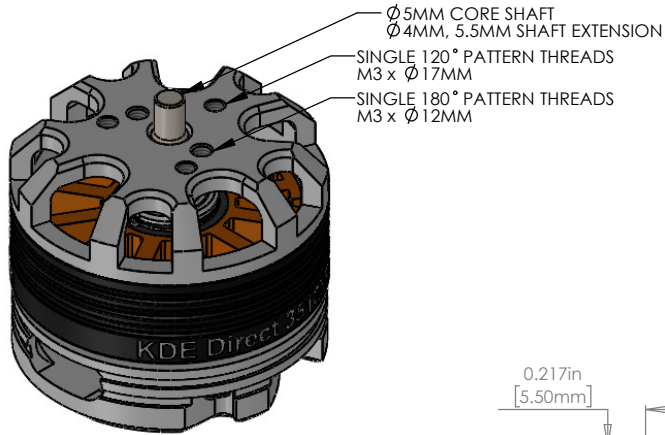

**KDE DIRECT UAS BRUSHLESS MOTOR SPECS.**

$\varnothing$  5mm Core Shaft  
 $\varnothing$  4mm, 5.5mm Extended Length  
 - Shaft Flush with Retaining Collar

MR105ZZ Upper Bearing ( $\varnothing$  5mm x  $\varnothing$  10mm x 4mm)  
 - Double Upper Bearings  
 625ZZ Lower Bearing ( $\varnothing$  5mm x  $\varnothing$  16mm x 5mm)

Single 120° Pattern Threads:  
 M3 Threads x  $\varnothing$  17mm Spacing

Single 180° Pattern Threads:  
 M3 Threads x  $\varnothing$  12mm Spacing

Dual 90° Pattern Threads:  
 M4 Threads x  $\varnothing$  25mm Spacing  
 M3 Threads x  $\varnothing$  25mm Spacing

Dual 120° Pattern Threads:  
 M3 Threads x  $\varnothing$  32mm Spacing  
 M2.5 Threads x  $\varnothing$  32mm Spacing

30" Exit Lead Extensions (15 AWG)  
 $\varnothing$  3.5mm 24k Bullets, Pre-Soldered and Shrink Wrap

