

DRAFT COPY

DO NOT SCALE. IF IN DOUBT ASK!

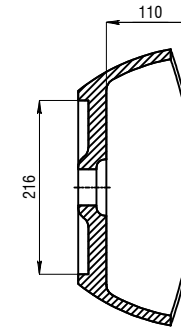

SECTION B-B

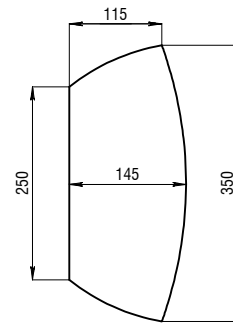
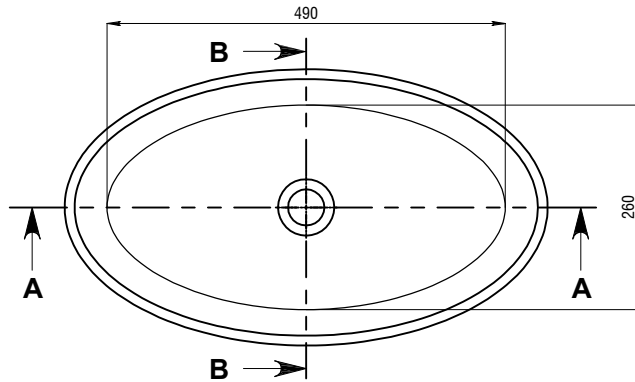
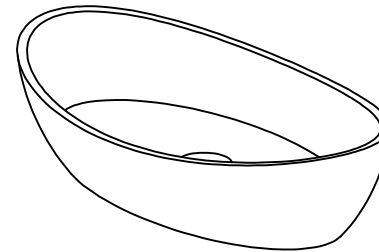
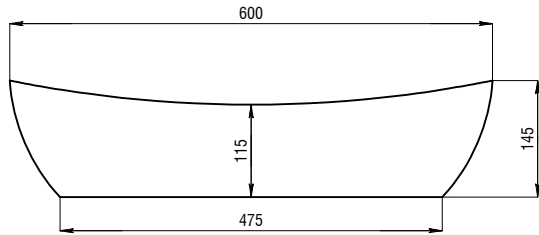
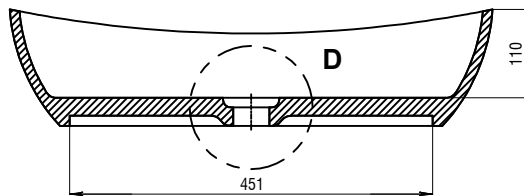

SECTION A-A

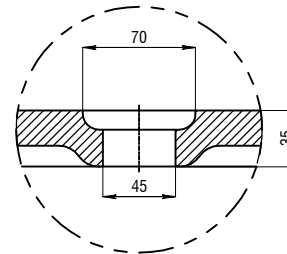

**DETAIL D
SCALE 1:2**

COLOUR
QTY
APPROVED BY:
NAME & SIGNATURE
DATE APPROVED:

NOTES
 1. ALL INTERNAL CORNERS TO BE R5 UNLESS OTHERWISE STATED.
 2. BASINS IN AUSTRALIA COME WITH GLOSS FINISH ONLY ON SPECIAL ORDER - 8 WEEKS DELAY (SURCHARGE APPLIES).
 ALL BASINS DO NOT COME WITH A WASTE FITTING.

COPYRIGHT © APPLIES		DUPLICATION OF THIS DRAWING OR ANY SPECIFIC DESIGN FEATURES IS NOT PERMITTED WITHOUT WRITTEN AUTHORITY. "COMMERCIAL CONFIDENTIALITY" IS ASSUMED AND REQUIRED.	
UNLESS OTHERWISE STATED ALL DIMENSIONS IN MILLIMETERS		MATERIAL: KASKADE STONE	DRAWING NUMBER: RSA-24
DRAWING LEGEND		FINISH: REFER TO ORDER	SCALE 1:1 A4
		N.W: 11 kg Product Size: 600X350X145	SHEET 1 OF 1 REV: 1
		G.W: kg Package size	 KASKADE STONE www.kaskadebaths.de
		LINEAR / ANGULAR TOLERANCES	
		DRAWN: KASKADE DATE: 02/03/15	
		No Decimals 1 Decimal 2 Decimals	
		±5 ±3°	

REV	DESCRIPTION	DWG	DATE	CHK'D	DATE
1	RELEASE DATE.	KASKADE	02/03/15		