

VIBE

**NOISEMONSTER™**  
sound to silence acoustic seating

## Acoustic Armchair

Spock fabric + metal legs Pencil / Sled

Design 2022 / NoiseMonster



DURABLE



SAFE



GUARANTEE



VERSATILE



SOUND ABSORBANT

prodotto

**MADE  
IN  
ITALY**

artigianale



NOISEMONSTER™ Brand is Trade Marked & Copy Right protected for NVP Company Ltd./London/United Kingdom /2022

VIBE/SPOCK FABRIC+METAL LEGS/ ACOUSTIC ARMCHAIR DATA SHEET

[www.noisemonster.it](http://www.noisemonster.it)

NOISEMONSTER Brand is Trade Marked & Copy Right protected for NVP Company Ltd./London/United Kingdom /2022  
sound to silence acoustic panels

# VIBE

## Acoustic Armchair / Spock fabric + metal Pencil Legs

Design 2022 / NoiseMonster

Vibe acoustic armchair is ideal for smart working, multi-function areas, meeting and conference rooms, cafes, restaurants, schools and libraries.

Perfect for any interior where the reverberation of sound is an issue and style is a priority.

### OUTER SHELL

High performance durable plastic shell.

### INNER SHELL

High performance durable plastic shell.

### PADDING

FR polyurethan foam / EN1021-2

California 117-2013

BS5852-2

### LEGS

Pencil leg metal frame style

ø16, thick 2mm

Black or chrome



### DIMENSIONS

- Width 580mm
- Depth 520mm
- Height 810mm
- Seat Height 500mm
- Arm Height 710mm



VIBE/SPOCK FABRIC+METAL LEGS/ACOUSTIC ARMCHAIR DATA SHEET

VIBE

Acoustic Armchair / Spock fabric +metal Pencil Legs

Design 2022 / NoiseMonster

INNER SHELL FABRIC



Fabric SOFTY

Martindale 55.000

Fire Retardant California 117-2013

Cleaning Water & mild detergent for most stains

Colour



09

OUTER SHELL FABRIC

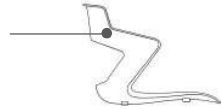

Fabric SPOCK

Martindale 120.000

Fire Retardant California 17-2013

Cleaning Water & mild detergent for most stains

Colours



SNOW  
01



DUNE  
02



WOOD  
03



BUMBLEBEE  
04

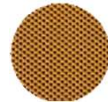

HONEY  
05



COFFEE  
06



CORAL ORANGE  
07



CANDY RED  
08



BORDEAUX  
09

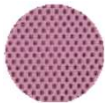

VIOLET  
10



JUNIPER  
11

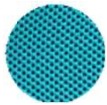

TURQUOISE  
12



RIVER GREEN  
13



ROYAL BLUE  
14



DENIM  
15

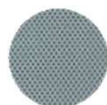

SILVER  
16



GRAPHITE  
17



BLACK  
18

LEGS

Black Pencil Legs



Chrome Pencil Legs



Adjustable glides

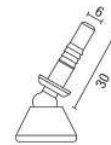

BLACK



WHITE

NOISEMONSTER™ Brand is Trade Marked & Copy Right protected for NVP Company Ltd./London/United Kingdom /2022

VIBE/SPOCK FABRIC+METAL LEGS/ACOUSTIC ARMCHAIR DATA SHEET

VIBE

Acoustic Armchair / Spock fabric + metal Pencil Legs

Design 2022 / NoiseMonster

Vibe armchairs with metal pencil legs - black or chrome, dressed in triple layer acoustic fabric Spock.

Good vibes only!

NOISEMONSTER™ Brand is Trade Marked & Copy Right protected for NVP Company Ltd./London/United Kingdom /2022

					
					
SNOW VIBE VIBE-BLP-SNO-S01	SNOW VIBE VIBE-CHP-SNO-S01	DUNE VIBE VIBE-BLP-DUN-S02	DUNE VIBE VIBE-CHP-DUN-S02	WOOD VIBE VIBE-BLP-WOO-S03	WOOD VIBE VIBE-CHP-WOO-S03
					
BUMBLEBEE VIBE VIBE-BLP-BUM-S04	BUMBLEBEE VIBE VIBE-CHP-BUM-S04	HONEY VIBE VIBE-BLP-HON-S05	HONEY VIBE VIBE-CHP-HON-S05	COFFEE VIBE VIBE-BLP-COF-S06	COFFEE VIBE VIBE-CHP-COF-S06
					
CORAL ORANGE VIBE VIBE-BLP-COR-S07	CORAL ORANGE VIBE VIBE-CHP-COR-S07	CANDY RED VIBE VIBE-BLP-CAN-S08	CANDY RED VIBE VIBE-CHP-CAN-S08	BORDEAUX VIBE VIBE-BLP-BOR-S09	BORDEAUX VIBE VIBE-CHP-BOR-S09
					
VIOLET VIBE VIBE-BLP-VIO-S10	VIOLET VIBE VIBE-CHP-VIO-S10	JUNIPER VIBE VIBE-BLP-JUN-S11	JUNIPER VIBE VIBE-CHP-JUN-S11	TURQUOISE VIBE VIBE-BLP-TUR-S12	TURQUOISE VIBE VIBE-CHP-TUR-S12
					
RIVER GREEN VIBE VIBE-BLP-RIV-S13	RIVER GREEN VIBE VIBE-CHP-RIV-S13	ROYAL BLUE VIBE VIBE-BLP-ROY-S14	ROYAL BLUE VIBE VIBE-CHP-ROY-S14	DENIM VIBE VIBE-BLP-DEN-S15	DENIM VIBE VIBE-CHP-DEN-S15
					
SILVER VIBE VIBE-BLP-SIL-S16	SILVER VIBE VIBE-CHP-SIL-S16	GRAPHITE VIBE VIBE-BLP-GRA-S17	GRAPHITE VIBE VIBE-CHP-GRA-S17	BLACK VIBE VIBE-BLP-BLA-S18	BLACK VIBE VIBE-CHP-BLA-S18

VIBE/SPOCK FABRIC+METAL LEGS/ACOUSTIC ARMCHAIR DATA SHEET

# VIBE

## Acoustic Armchair / Spock fabric +metal Sled Legs

Design 2022 / NoiseMonster

Vibe acoustic armchair is ideal for smart working, multi-function areas, meeting and conference rooms, cafes, restaurants, schools and libraries.

Perfect for any interior where the reverberation of sound is an issue and style is a priority.

### OUTER SHELL

High performance durable plastic shell.

### INNER SHELL

High performance durable plastic shell.

### PADDING

FR polyurethan foam / EN1021-2

California 117-2013

BS5852-2

### LEGS

Sled metal frame style  $\varnothing 12$

Black or chrome



### DIMENSIONS

Width	580mm
Depth	550mm
Height	810mm
Seat Height	500mm
Arm Height	710mm

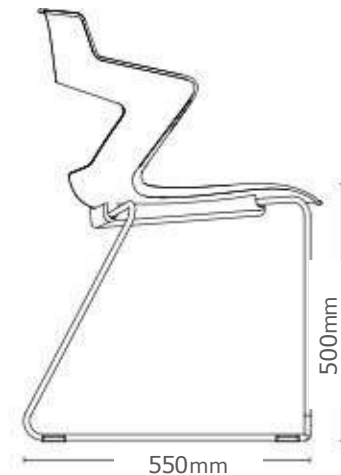
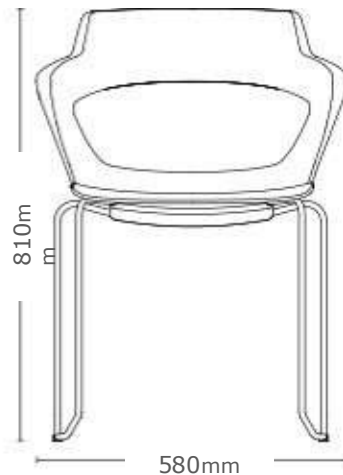

VIBE

Acoustic Armchair / Spock fabric +metal Sled Legs

Design 2022 / NoiseMonster

INNER SHELL FABRIC



Fabric SOFTY

Martindale 55.000

Fire Retardant California 117-2013

Cleaning Water & mild detergent for most stains

Colour



09

OUTER SHELL FABRIC

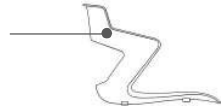

Fabric SPOCK

Martindale 120.000

Fire Retardant California 17-2013

Cleaning Water & mild detergent for most stains

Colours



SNOW  
01



DUNE  
02



WOOD  
03

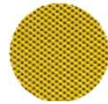

BUMBLEBEE  
04



HONEY  
05



COFFEE  
06



CORAL ORANGE  
07

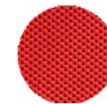

CANDY RED  
08

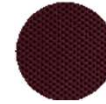

BORDEAUX  
09

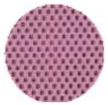

VIOLET  
10



JUNIPER  
11

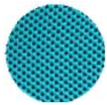

TURQUOISE  
12



RIVER GREEN  
13



ROYAL BLUE  
14



DENIM  
15

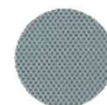

SILVER  
16



GRAPHITE  
17



BLACK  
18

LEGS

Black Sled Legs

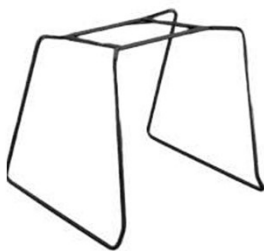

Chrome Sled Legs



Adjustable glides

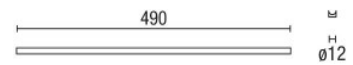

TRANSPARENT

NOISEMONSTER™ Brand is Trade Marked & Copy Right protected for NVP Company Ltd./London/United Kingdom /2022

VIBE / SPOCK FABRIC + METAL LEGS / ACOUSTIC ARMCHAIR DATA SHEET

VIBE













Acoustic Armchair / Spock fabric + metal Sled Legs

Design 2022 / NoiseMonster

Vibe armchairs with metal sled legs - black or chrome, dressed in triple layer acoustic fabric Spock.

Colourful and good vibes only!

NOISEMONSTER™ Brand is Trade Marked & Copy Right protected for NVP Company Ltd./London/United Kingdom /2022

					
					
SNOW VIBE VIBE-BLP-SNO-S01	SNOW VIBE VIBE-CHP-SNO-S01	DUNE VIBE VIBE-BLP-DUN-S02	DUNE VIBE VIBE-CHP-DUN-S02	WOOD VIBE VIBE-BLP-WOO-S03	WOOD VIBE VIBE-CHP-WOO-S03
					
BUMBLEBEE VIBE VIBE-BLP-BUM-S04	BUMBLEBEE VIBE VIBE-CHP-BUM-S04	HONEY VIBE VIBE-BLP-HON-S05	HONEY VIBE VIBE-CHP-HON-S05	COFFEE VIBE VIBE-BLP-COF-S06	COFFEE VIBE VIBE-CHP-COF-S06
					
CORAL ORANGE VIBE VIBE-BLP-COR-S07	CORAL ORANGE VIBE VIBE-CHP-COR-S07	CANDY RED VIBE VIBE-BLP-CAN-S08	CANDY RED VIBE VIBE-CHP-CAN-S08	BORDEAUX VIBE VIBE-BLP-BOR-S09	BORDEAUX VIBE VIBE-CHP-BOR-S09
					
VIOLET VIBE VIBE-BLP-VIO-S10	VIOLET VIBE VIBE-CHP-VIO-S10	JUNIPER VIBE VIBE-BLP-JUN-S11	JUNIPER VIBE VIBE-CHP-JUN-S11	TURQUOISE VIBE VIBE-BLP-TUR-S12	TURQUOISE VIBE VIBE-CHP-TUR-S12
					
RIVER GREEN VIBE VIBE-BLP-RIV-S13	RIVER GREEN VIBE VIBE-CHP-RIV-S13	ROYAL BLUE VIBE VIBE-BLP-ROY-S14	ROYAL BLUE VIBE VIBE-CHP-ROY-S14	DENIM VIBE VIBE-BLP-DEN-S15	DENIM VIBE VIBE-CHP-DEN-S15
					
SILVER VIBE VIBE-BLP-SIL-S16	SILVER VIBE VIBE-CHP-SIL-S16	GRAPHITE VIBE VIBE-BLP-GRA-S17	GRAPHITE VIBE VIBE-CHP-GRA-S17	BLACK VIBE VIBE-BLP-BLA-S18	BLACK VIBE VIBE-CHP-BLA-S18

VIBE/SPOCK FABRIC+METAL LEGS/ACOUSTIC ARMCHAIR DATA SHEET

# VIBE

## Acoustic Armchair / Spock fabric + metal Sled / Pencil Legs

Design 2022 / NoiseMonster

To make sure you receive your Vibe in desired colour and style, please follow important ordering instructions below.

### ORDERING

When ordering please mentioned the following

- Chair Code
- Chair Name
- Chair Fabric Colour
- Chair Legs Style        / Pencil or Sled
- Chair Legs Colour     / Black or Chrome

### PACKAGING

1 chair per carton box

### BOX DIMENSIONS

- W 600mm
- D 570mm
- H 820mm

### BOX VOLUME

0.280 m<sup>3</sup>

### CUSTOM METAL COLOURS

- 30% additional cost on list prices
- Minimum order quantity 100 pieces