

ionmax

BREEZE

AIR PURIFIER

ION420



USER MANUAL

DEAR CUSTOMER

Thank you for purchasing the Ionmax Breeze ION420 Air Purifier. The Ionmax Breeze can help to improve the indoor air quality in your home or office.

Please read this manual carefully before use to ensure proper usage and save these instructions for future reference.

The package includes:

- ION420 Breeze Air Purifier
- User Manual

Note: Verify that plastic bags are removed from filters, if equipped or installed, before first use (see page 8)

CONTENTS

SAFETY INSTRUCTIONS	1
PRODUCT DIAGRAM	2
SPECIFICATIONS	2
PURIFICATION SYSTEM	3
CONTROL PANEL	4
OPERATING INSTRUCTIONS	5
MAINTENANCE INSTRUCTIONS	6
FILTER REPLACEMENT	7
TROUBLESHOOTING GUIDE	10
WARRANTY DETAILS	11
WARRANTY REGISTRATION	13

SAFETY INSTRUCTIONS



PLEASE READ ALL THE TIPS AND WARNINGS BELOW BEFORE USING THE AIR PURIFIER.

- Use only as directed in the User Manual.
- Do not allow children or persons with reduced physical, sensory, or mental capabilities to operate the unit without adult supervision.
- Only designed for use in a 220-240V, 50Hz outlet.
- Use indoors only.
- Only operate the unit when it is fully assembled.
- Never touch the unit with wet hands or allow it to come into contact with water.
- Turn off all controls before unplugging the power supply.
- Always disconnect the unit from the power supply before moving or cleaning the unit, and when the unit is not in use.
- When removing the power plug, always hold the plug and never pull the cord.
- This air purifier is not a substitute for proper ventilation, regular vacuum cleaning or an extractor hood or fan while cooking.
- Leave at least 20cm of space behind and on both sides of the unit and leave at least 30cm space above the unit.
- When the unit is in operation, please place it at least 2m away from equipment that emits electric waves such as televisions, radios and clocks, to prevent electrical interference from occurring.
- Do not use the unit in bathrooms, kitchens, humid areas, near fireplaces, or place it in proximity to flammable or combustible products, as electric shock and a fire hazard may result.
- Do not clean the unit with water or any other liquid including flammable products.
- Never operate the unit if the plug or cord appears damaged. Contact the authorised distributor or qualified personnel immediately for examination and repair.
- Do not insert fingers or foreign objects into the air intake or air outlet, or block them by placing items on the air outlet or in front of the air intake.
- Do not place anything on top of the unit and do not sit on the unit.
- Do not place the unit directly below an air conditioner as condensation may drip into the unit.
- Do not operate this unit when using indoor insect repellents (aerosols) or in places with oily residues, burning incense or chemical fumes.
- Do not use the unit in a room with major temperature changes, as this may cause condensation inside the unit.

PRODUCT DIAGRAM

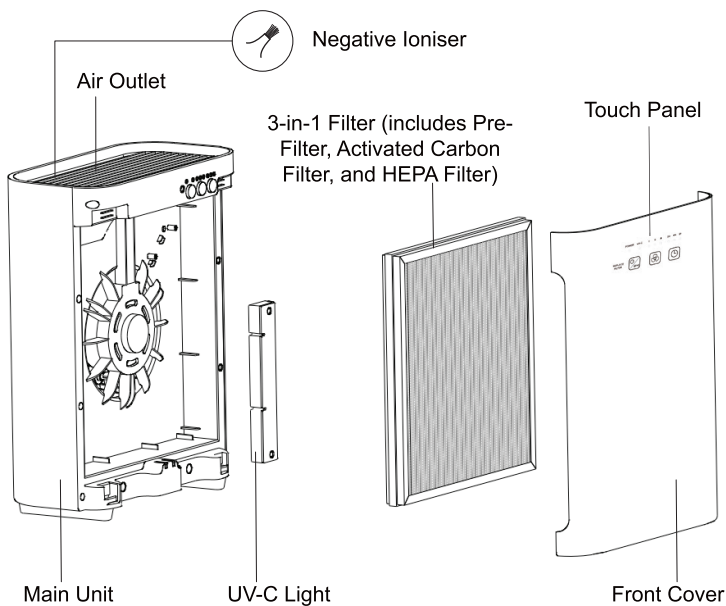

SPECIFICATIONS

Model	Ionmax ION420
Voltage	220-240V, 50Hz
Power Rating	55W
Coverage Area	Up to 35 m ²
Germs Killed	99%
Noise Level	Low: 30dB, Medium: 40dB, High: 50dB
Air Flow	Low: 65m ³ /h; Medium: 183m ³ /h; High: 236m ³ /h
UV Life	≥10,000 Hours
Filter Life	12 months (based on typical use)
Weight	4.2 KG
Dimensions	162 (L) x 324 (W) x 409 (H) mm

PURIFICATION SYSTEM

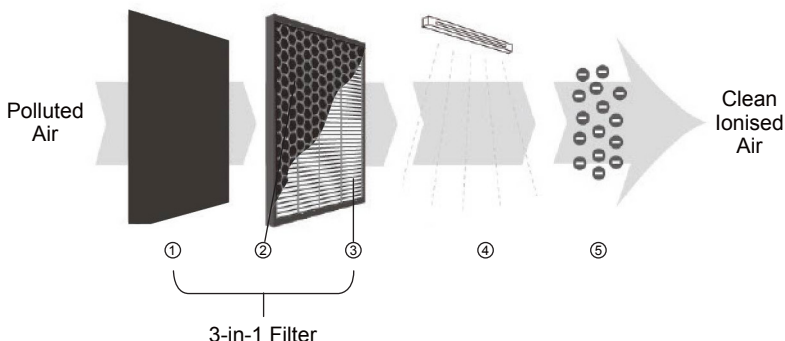

The Pre-Filter, HEPA Filter and Activated Carbon Filter are combined into one easy-to-change filter.

1. Cleanable Pre-Filter

Traps large particles such as human hair, pet dander and dust particles. Helps to extend the life of the HEPA and Activated Carbon filters.

2. Activated Carbon Filter

Neutralises odours and other Volatile Organic Compounds (VOC's) such as formaldehyde and benzene, as well as other harmful fumes emitted by household products.

3. True HEPA Filter

Traps up to 99.97% of allergens and airborne contaminants down to 0.3 microns in size. These allergens include lung damaging dust, mould spores, plant spores, pet dander and pollen.

4. UV-C Light (254NM)

Kills airborne germs, viruses, fungi and bacteria.

5. Negative Ions

Improve indoor air quality by combining with dust or reacting with odour molecules and removing them from the air we breathe.

CONTROL PANEL

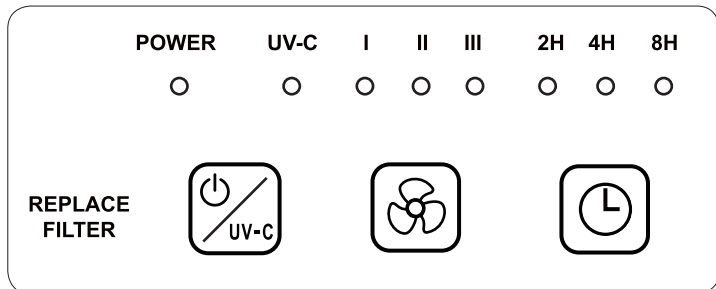

“POWER / UV-C” BUTTON

Press this button to turn on or switch off the unit. The UV-C light and Ion generator are also controlled by this button.

Note: Ion generator is controlled by the same settings as the UV-C light.



“FAN SPEED” BUTTON

The fan speed of the unit can be adjusted between Low (I), Medium (II) and High (III) when the unit is in operation.



“TIMER” BUTTON

The air purifier can be timed to operate for intervals of 2 hours, 4 hours or 8 hours, stopping automatically when the selected operating time has elapsed.

To select the continuous operating mode, press the button repeatedly until all three timer lights are off.

REPLACE FILTER See page 7.

Important note: When the unit is not in use, switch it off and unplug it.

OPERATING INSTRUCTIONS

USING THE APPLIANCE

-  **Power / UV-C button**
Press this button to turn the unit on or off. The Negative Ion generator automatically starts up and shuts down at the same time as the UV-C light.

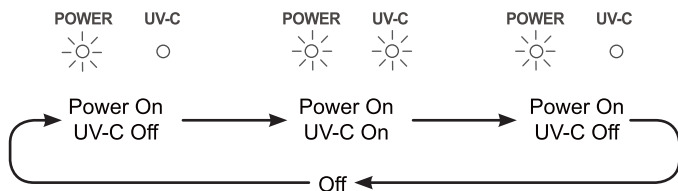

-  **Fan speed button**
Press this button one or more times to select the desired fan speed. The corresponding fan speed indicator lights up to indicate the current fan speed (Low, Med, High).

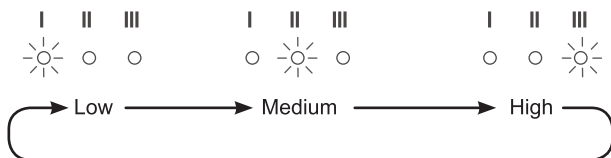

-  **Timer button**
Press this button to select the timer settings for 2, 4 or 8 hours.

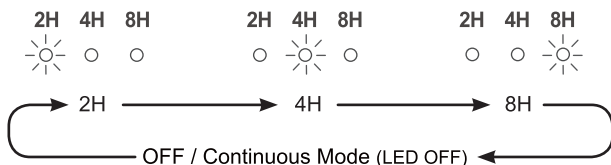

MAINTENANCE INSTRUCTIONS

CLEANING THE UNIT

- Always unplug the power supply before cleaning the unit.
- Do not put the unit into water or use water to wash it directly.
- Do not use any corrosive or flammable detergent to clean the unit.
- Use a soft cloth with daily cleanser to clean the unit, and make sure the unit is completely dry after cleaning.
- Regularly clean the inside and surface, to prevent dust from gathering.
- Regularly clean the air intake and air outlet.
- To maintain or replace filters, see page 7.

STORAGE INSTRUCTIONS

If the unit will not be in use for a long time, please pack and store it properly:

- Unplug the power supply of the unit.
- Clean the pre-filter.
- Use a soft cloth to clean the air intake and air outlet.

CAUTION

Proper use and regular maintenance can ensure efficient operation and extend the life of the unit. Do not attempt to repair or adjust any electrical or mechanical functions on this unit. All servicing should be performed by qualified personnel only.

FILTER REPLACEMENT

FILTER REPLACEMENT INDICATOR

When the “Power” indicator flashes during operation, it indicates that the HEPA and Activated Carbon filters need to be replaced.

REPLACING THE FILTERS

Follow the Filter Replacement Instructions (page 8) to change the filters.

After replacing the filters, with the power off, press and hold the power button for 5 seconds to reset the indicator light.

The built-in timer for the filter replacement indicator is 4,320 hours.

Note: The expected filter lifetime is 6 months (if used 24 hours daily) or 12 months (if used 12 hours daily).

PRE-FILTER MAINTENANCE

- The pre-filter is not washable.
- It can be gently vacuumed using hand tool attachments (no rotating brushes).
- Do not use any solutions, brushes or sharp objects to clean the pre-filter, as this can damage the filter.

HEPA / ACTIVATED CARBON FILTER REPLACEMENT

- The HEPA / Activated Carbon filter is not washable.
- The HEPA / Activated Carbon filter can be used for about 1 year or 6 months if used continuously, but its actual life depends on air quality condition and proper maintenance.

FILTER REPLACEMENT INSTRUCTIONS

The ION420 comes with the filters fitted inside, but you may need to remove plastic packaging from the filters before the first use of the air purifier.

When replacing with new filters, remove all packaging and place filters into the unit as described below.

Tip: Place the appliance against a wall for more stability when you remove or insert filters.

Note: Make sure you insert the filters in the correct position.



Step 1.

Place your fingers in the recesses of the side panels and gently pull the top part of the front panel towards you. Then, lift the hooks at the bottom of the panel out of the bottom of the unit.



Step 2.

Remove the pre-filter from the unit.

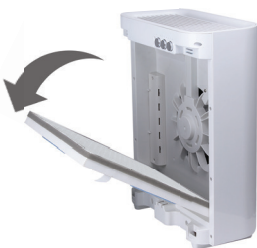

Step 3.

Remove the combined Activated Carbon and HEPA filters from the unit.

Step 4.

Remove all packaging material from the new filters.

Step 5.

Place the new Activated Carbon and HEPA filters into the unit, with the HEPA filter facing in and the black Activated Carbon filter facing out.



Make sure that the side with the tabs is facing you.

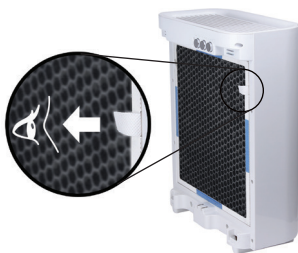

Step 6.

Place the new pre-filter into the unit.



Step 7.

To reattach the front panel, insert the bottom hooks into the bottom of the unit first. Then push the panel against the body of the unit.



TROUBLESHOOTING GUIDE

Problem	Probable Cause	Solution
Unit not operating	Power cable not plugged in	Plug in power cable
	Power cable not plugged in properly	Plug in power cable correctly
	Front cover not attached properly	Reattach the front cover
Loud noise	Filters not unpacked	Unpack the filter packaging (see Filter Replacement Instructions)
	Too much dust on pre-filter	Clean the pre-filter
	HEPA and Activated Carbon filters dirty	Replace HEPA and Activated Carbon filters
Abnormal noise	Loose parts inside the unit	Contact customer service centre
	Motor broken	
Indicator lights not switched on	Product circuit control failure	Contact customer service centre
UV-C indicator light is off	UV-C is switched off	Press the UV-C button
	UV-C light broken or needs replacement	Contact customer service centre
Reduced airflow	Filters are dirty	Replace filters
	Filters not unpacked	Unpack filters



WARRANTY DETAILS

Congratulations on your purchase! It is our aim to provide you with quality products that you can trust. Our products come with guarantees that cannot be excluded under the Australian Consumer Law. You are entitled to a replacement or a refund for a major failure and for compensation for any other reasonably foreseeable loss or damage.

You are also entitled to have the goods repaired or replaced if the goods fail to be of acceptable quality and the failure does not amount to a major failure.

The Guarantee

The product is guaranteed to be free from defects in workmanship and parts for a period of 12 months from date of purchase. Defects that occur within this warranty period, under normal use and care, will be repaired, replaced or refunded at our discretion, solely at our option with no charge for parts and labour. The benefits conferred by this warranty are in addition to all rights and remedies in respect of the product that the consumer has under the Trade Practices Act and similar state laws.

Proof of Purchase

This warranty is valid for the original purchase and is not transferable. Please keep your purchase docket or receipt as proof of purchase and as proof of date on which the purchase was made. The purchase docket (or a copy) or receipt must be presented with the warranty when making a claim under this warranty.

Service during the Warranty Period

To claim for warranty, contact us on 1300 800 200 or support@andatech.com.au to get an RA# (Return Authorisation Number) or submit a support ticket on my.andatech.com.au. Ensure that the RA# is clearly stated on the outside of the packaging and that the product is properly packaged so that no damage occurs to the product during transit. Shipping of the product back to us for warranty will be at your cost. A product return without the RA# or proof of purchase will not be accepted.

Extent of Warranty

This warranty is limited to defects in workmanship or parts. All defective products or parts will be repaired or replaced. This warranty does not cover manuals and packaging.

Normal Wear and Tear

This warranty does not cover normal wear and tear to the product or parts.

Exclusions

This warranty does not cover:

- Any defect caused by an accident, misuse, abuse, improper operation, lack of reasonable care, unauthorised modification, loss of parts, tampering or attempted repair by a person not authorised by the distributor.
- Any product that has been damaged by a lightning strike either directly or indirectly or a main power surge or liquid ingress.
- The product if it is located outside of Australia.
- Any damage caused by improper power input or improper cable connection.

Andatech Corporation Pty. Ltd.

PO Box 3038, Nunawading VIC 3131, Australia.

Phone: 1300 800 200 Fax: 1300 883 802 Email: support@andatech.com.au

A circular seal with a double-line border. Inside the seal, the text "1 YEAR" is written in a large, bold, sans-serif font, and "WARRANTY" is written in a smaller, bold, sans-serif font below it.

1 YEAR
WARRANTY

WARRANTY REGISTRATION

Register your Ionmax Breeze Ion420 online at my.andatech.com.au or fill out this form and forward to the address below with a copy of your proof of purchase. Contact us on 1300 800 200 or visit www.andatech.com.au for options to extend your warranty.

Andatech Corporation Pty Ltd
PO Box 3038, Nunawading VIC 3131, Australia.

Product	:	Ionmax Breeze Ion420
Date of Purchase	:	_____
Place of Purchase	:	_____
Serial No.	:	_____
Surname	:	_____
Given Name	:	_____
Address	:	_____
Suburb	:	_____
Postcode	:	_____
State	:	_____
Contact No.	:	_____
Email	:	_____





ionmax.com.au
1300 800 200

Version 1.2. Updated 2.10.2017