





BARBATE LED MIRROR



36" x 36"

We would love to hear back from you!
Email Us at: info@vicintamirrors.com
Website: www.vicintamirrors.com

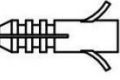
PACKAGE INCLUDING

A  1PC	B  1PC	Ca  3PCS+1	Cb  3PCS+1	Cc  1PC
--	--	--	--	---

A: Mounting Panel × 1

B: LED Mirror × 1

Ca: Expansion Screw × 3

Cb: Screw × 3

Cc: Manual × 1

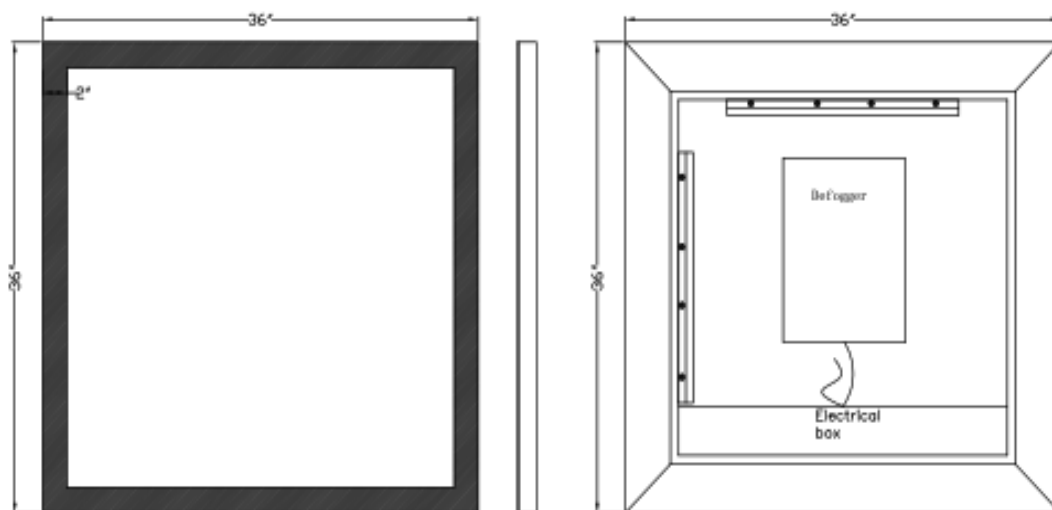

Warning

1. This product should only be installed by a fully qualified electrician.
2. Always switch off the electrical main supply before and after installation, as well as maintenance.
3. DO NOT connect to a plug and socket outlet. Suitable for indoor use only.
4. Do not use attachments not recommended by the manufacturer.
5. Never drop or insert any object.
6. Do not fix to damp or conductive surfaces .
7. Suitable for Bathroom Zones 2, 3 and non bathroom/dry areas. See diagram below.
8. NOT suitable for above baths or Zone 1 nor for installation in Saunas, Steam Rooms or shower Cubicles.

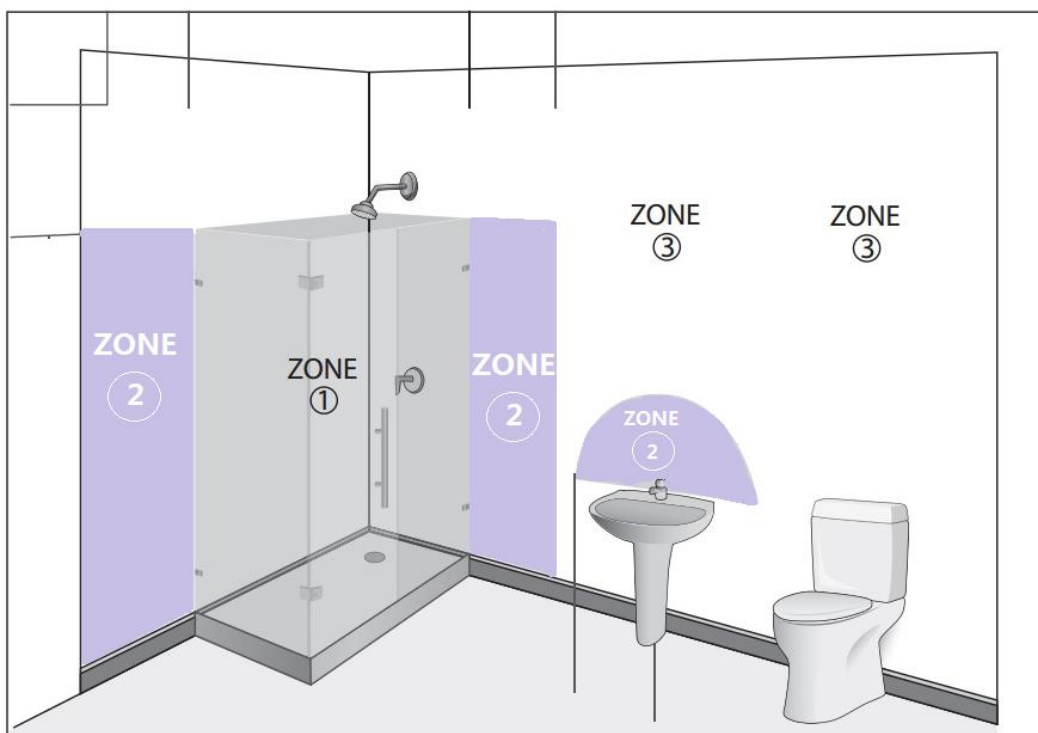

Before Installation

1. Inspect the product immediately upon receipt for transit damage or missing parts.
2. Handle the product with care and protect against knocks to all sides and edges of the glass.
3. Make sure that you have all the tools you need to complete the job (SEE BELOW)
4. Ensure there are no hidden pipes or cables in the wall before drilling.
5. If drilling holes in ceramic tiles use a piece of masking tape on the tile to stop the drill bit from slipping.

Note: All electric installation work should follow the local electrician regulations.

Afercare Instructons

1. Clean using a soft dry cloth only when turned off.
2. Never use cleaning agents or abrasive materials.
3. Do not allow moisture to come into contact with lamps.

Tools Used

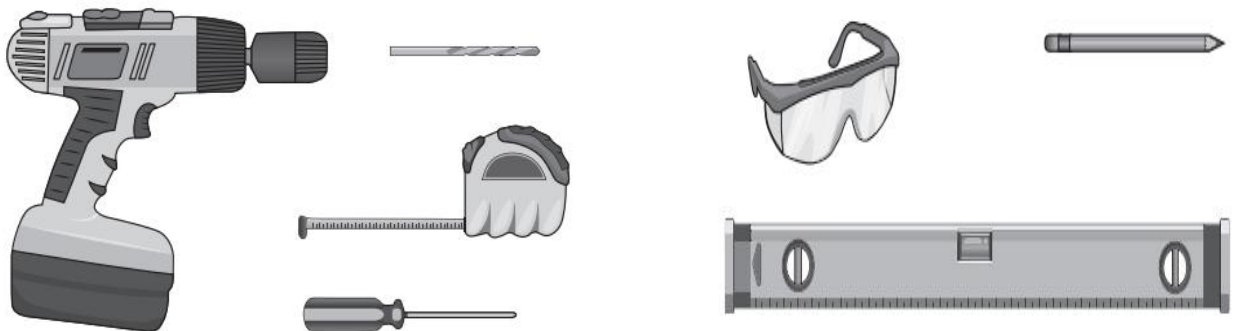

Installation Procedure

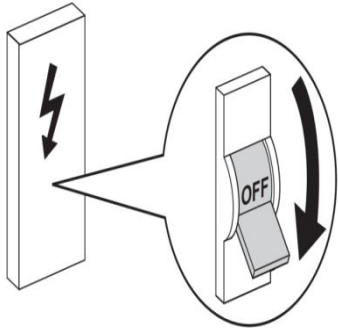

1. Turn off the electricity before beginning.

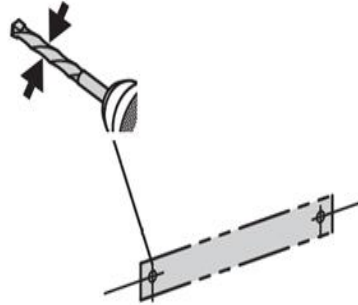

2. Mark the drill positions on the horizontal line, ensure the drill positions are horizontal by using a spirit level.



3. Wearing an eye protection, drill holes on the wall.

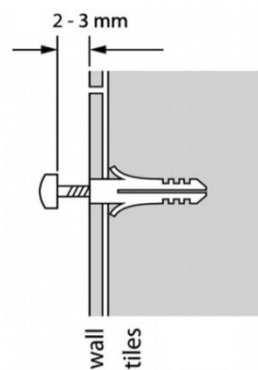

4. Insert wall plugs carefully.

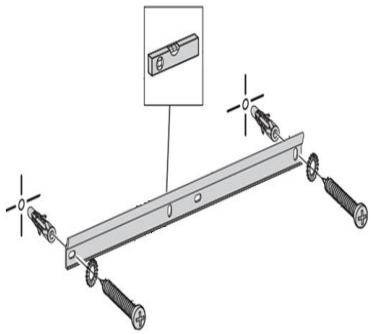

5. Fix the mounting bracket to the wall by screws.

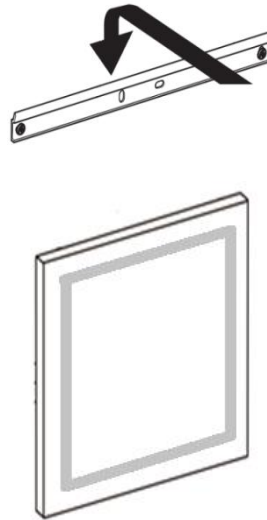

6. Hanging mirrors onto the bracket.

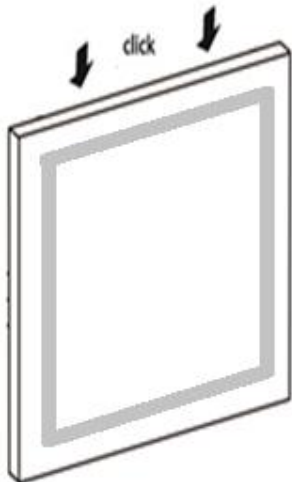

6. Click lightly to fix. Ensure mirror is securely mounted.

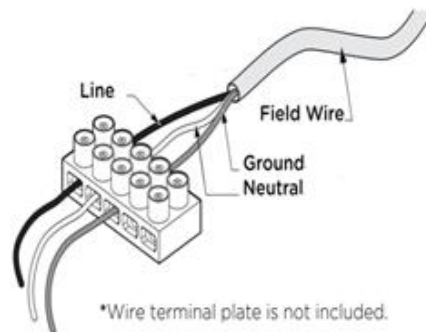

8. Connect mirror to electric power.

HARDWIRE INSTRUCTION

⚠️ INSTALLATION has to be made by a qualified/registered electrician. DO NOT attempt to install by yourself as WE will not be responsible if this product is not installed by a professional.

Before starting your installation, please make sure

- The wall surface must be of suitable strength and construction
- The main electricity supply has been power off

Each mirror is equipped with a plug. If you want to use a wall switch to control the mirror light, please cut the plug. Therefore, You could connect the wires that are coming out of the center of the back of the mirror directly to your electrical connection box. The lead contains 3 wires:

- Copper Wire (Green) = GROUND wire. Connect to the ground wire in your box, or to the box as a ground.
- White = NEUTRAL wire. Connect to the White neutral wire in your box.
- Black = HOT wire. Connect to the Black hot wire in your box.

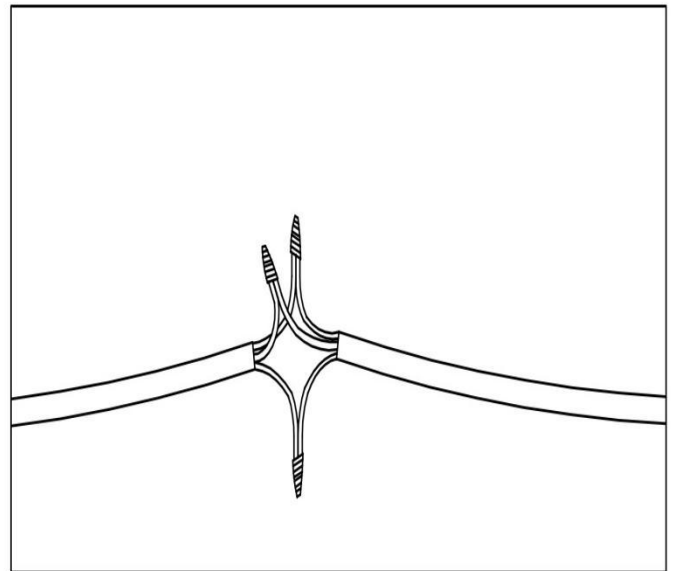
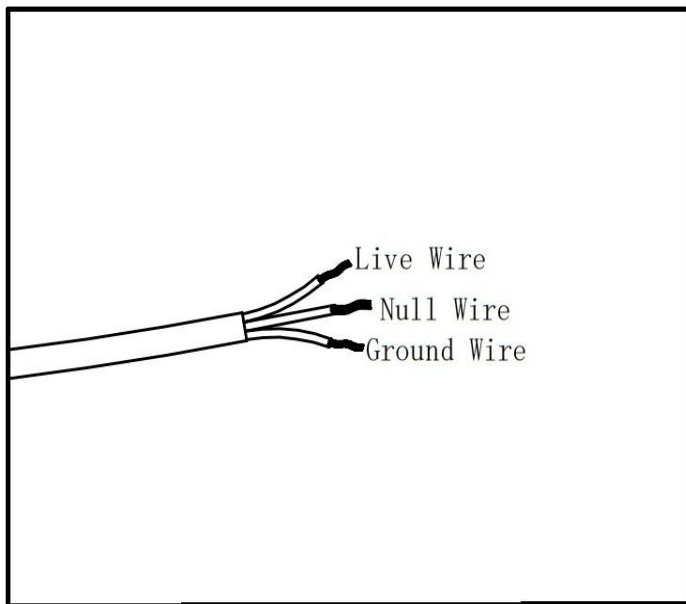

- (1) Cut the plug. You would see there three wires with three colors--white, green and black.
- (2) Safely connect these three wires one by one to the wires of wall switch in your home.

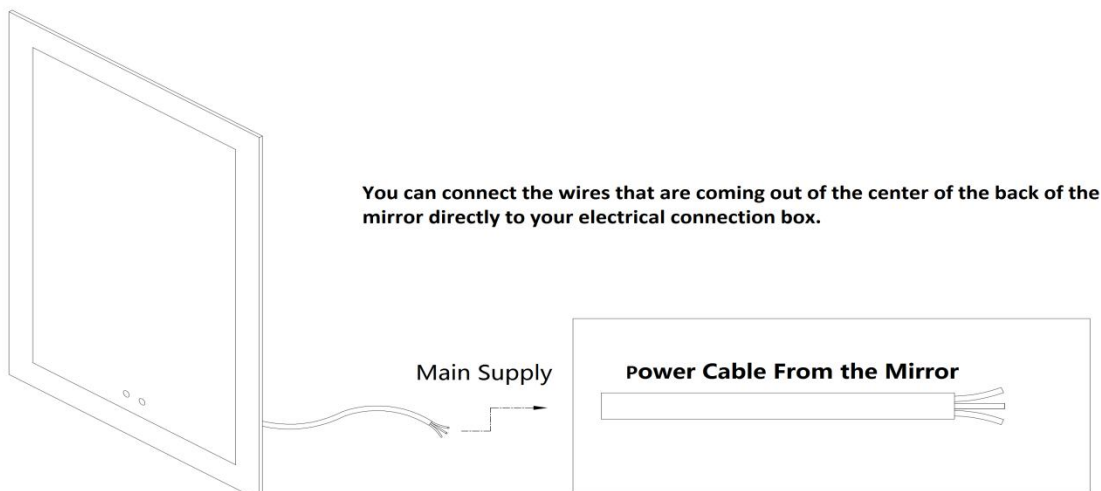

Operating Instructions

Turn on the light by the switch, and the heating pads works by the switch.

After Care Instructions:

1. Always switch off the electrical supply at the mains during installation and maintenance.
2. LED's have a life expectancy of 120,000 hours of continuous use. All LED light fittings and electric parts are replaceable and are available through NRG Mirror customer service.
3. Cleaning & Maintenance: it is recommended that the unit is cleaned with a soft, dry, non-abrasive cloth when turned off. Never use cleaning agents or abrasive material on any type of surface finish.
4. Do not strike glass components with hard or pointed items.
5. Do not place very hot or cold items against or close proximity to glass surfaces.
6. Wipe off all water spillages as soon as possible using a soft, damp cloth.

Return and Exchange Policy

Thank you for shopping at Vicinta Mirrors. If you are not entirely satisfied with your purchase, we're here to help.

14 Day Money Back Guarantee

Whatever the reason may be, if you are not entirely satisfied with your purchase, please email us at info@vicintamirrors.com with your order # and reason for return within 14-days of the date you receive the mirror and we will offer you a refund or an exchange.

To be eligible for a return or an exchange, please read the below information carefully:

- Mirrors must be returned with all of the accessories and its original content.
- Returns will not be accepted if the mirror is installed or used.
- The mirror must be unused and must be in its original packaging box.
- The original shipping cost will not be refunded. Shipping costs are non-refundable.
- The return shipping cost will be at the expense of the customer.
- Returns will not be accepted if the mirror is returned without contacting us first.

Inspection upon Reception of the Mirror:

- Upon reception of the mirror, it is very important to inspect the mirror immediately and thoroughly.
- It is important to inform us of any potential damages prior to installation of the mirror. Once a mirror is installed & fitted to the wall, damage claims will not be warranted.
- You must contact us within 14-days of the reception of the mirror for a refund or an exchange.
- Damaged mirror claims will not be warranted beyond the 14-days claim period.

