

TANITA

Instruction Manual Body Composition Monitor **BC-402**

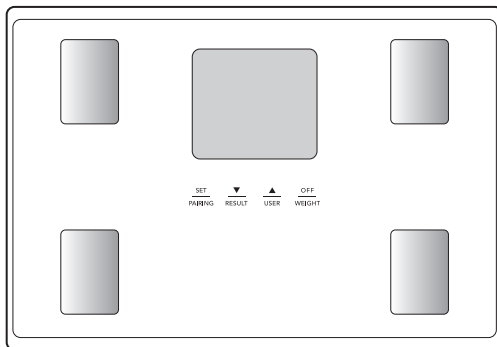

Images in this manual are for illustrative purposes only.

Read this Instruction Manual carefully and keep it for future reference.

Table of Contents

| | |
|--|----|
| Introduction | 3 |
| For Your Safety | 4 |
| Features and Functions | 6 |
| Preparations Before Use | 6 |
| Changing the Weight Mode | 7 |
| Automatic Shut-down Function | 7 |
| Getting Accurate Readings | 7 |
| Initial Setup (Type 1) Setup via Smartphone | 8 |
| Initial Setup (Type 2) from Body Composition Monitor | 10 |
| Taking Measurements | 11 |
| Setting and Storing Personal Data in Memory | 12 |
| Taking Weight and Body Fat Readings | 14 |
| Programming the Guest Mode | 16 |
| Taking Weight Measurement Only | 16 |
| Changing Personal Data | 16 |
| Erasing Personal Data | 16 |
| Troubleshooting | 17 |

Introduction

Thank you for selecting a TANITA Body Composition Monitor. This monitor is one in a wide range of home healthcare products produced by TANITA.

This Instruction Manual will guide you through the setup procedures and outline the key features. Please keep it handy for future reference. Additional information on healthy living can be found on our website www.tanita.asia.

TANITA products incorporate the latest clinical research and technological innovations.

All data is monitored by our TANITA Medical Advisory Board to ensure accuracy.



Note: Read this Instruction Manual carefully and keep it handy for future reference.

Safety Precautions

Note that people with an electronic medical implant, such as a pacemaker, should not use a Body Composition Monitor as it passes a low-level electrical signal through the body, which may interfere with its operation.

Pregnant women should use the weight function only. All other functions are not intended for pregnant women.

Do not place this monitor on slippery surfaces such as a wet floor.

Important Notes for Users

This Body fat monitor is intended for adults and children (ages 5 – 17) with inactive to moderately active lifestyles and adults with athletic body types.

TANITA defines “athlete” as a person involved in intense physical activity of approximately 12 hours per week and who has a resting heart rate of approximately 60 beats per minute or less. TANITA’s athlete definition includes “lifetime of fitness” individuals who have been fit for years but currently exercise less than 12 hours per week.

The body fat monitor function is not intended for pregnant women, professional athletes or bodybuilders.





Recorded data may be lost if the unit is used incorrectly or is exposed to electrical power surges. TANITA takes no responsibility for any kind of loss caused by the loss of recorded data.

TANITA takes no responsibility for any kind of damage or loss caused by these units, or any kind of claim made by a third person.

Note: Body fat percentage estimates will vary with the amount of water in the body, and can be affected by dehydration or over-hydration due to such factors as alcohol consumption, menstruation, illness, intense exercise, etc.

For Your Safety

This section explains precautionary measures to be taken to avoid injury to the users of this device and others, and to prevent damage to property. Please familiarise yourself with this information to ensure safe operation of this equipment.

| | |
|---|---|
|  Warning | Failure to follow instructions highlighted with this mark could result in death or severe injury. |
|  Caution | Failure to follow instructions highlighted with this mark could result in injury or damage to property. |
|  Prohibited | This mark indicates actions that are prohibited. |
|  Required | This mark indicates instructions that must always be followed. |

Warning

| | |
|--|--|
|  Prohibited | This monitor must not be used by people with pacemakers or other medical implants. This monitor passes a weak electrical current through the body which could interfere with and cause the malfunction of electrical medical implants, resulting in serious harm to the user. |
| | Interpretation of measurements (e.g. evaluation of measurements and formulation of exercise programmes based on the measurements) must be performed by a professional. Implementing weight loss measures and exercise programmes based on self-analysis could be harmful to your health. Always follow the advice of a qualified professional. |
| | Do not step on the edge of the platform. Do not jump onto the monitor. Doing so may cause you to fall or slip, resulting in serious injury. |
| | Do not place this monitor on a slippery surface such as a wet floor. Doing so may cause you to fall or slip, resulting in serious injury. It may also cause water to get inside the monitor resulting in damage to internal components. |
| | Do not drop any objects onto the monitor. Avoid excessive impact or vibration to the monitor. Doing so may damage the glass, resulting in injury. |

Caution

| | |
|--|--|
|  Prohibited | Do not stand on the display screen. |
| | Do not insert your fingers into gaps or holes. Doing so may result in injury. |
| | Do not use rechargeable batteries. Do not use old batteries together with new batteries, or a mix of different types of batteries at the same time. Doing so may cause battery fluid to leak or the batteries to become excessively hot and rupture, resulting in damage to the monitor or injury. |
| | Never allow an infant or small child to carry the monitor. The child may drop the monitor, resulting in injury. |
| | This monitor is intended for home use only. This monitor is not intended for professional use including hospitals, medical or fitness facilities. It is not equipped with the components required for heavy usage. Using the monitor in a professional location will invalidate the warranty. |



Required

Place the monitor on a hard, flat surface where there is minimal vibration to ensure safe and accurate measurement.

Avoid excessive impact or vibration to the monitor.

Doing so may damage the monitor or cause it to malfunction, or may cause settings to be erased.

Do not use or store this monitor in the following locations.

-Locations that are exposed to direct sunlight, near to heaters, or exposed directly to air from air conditioning units, etc.

-Locations where there are severe temperature changes or a large amount of vibration.

-Locations with high levels of humidity or moisture.

Doing so may damage the monitor or cause it to malfunction.

Do not step on the monitor when your body is wet (immediately after a shower or bath, etc.).

Be sure to thoroughly dry your body and feet before using the monitor. Failure to do so may cause you to slip or fall, resulting in injury. Also, the monitor cannot take accurate measurements if your body or feet are wet.

Keep away from water.

Do not use boiling water, benzene, thinner, etc. to clean the monitor.

If the monitor becomes dirty, soak a soft cloth in water or neutral household detergent, wring it out thoroughly and wipe the monitor clean, then use a dry cloth to wipe the monitor dry.

Do not attempt to disassemble the monitor. Do not modify this equipment in any way.

Do not wash the monitor in water.

Do not submerge this monitor in water.

Doing so may damage the monitor or cause it to malfunction.

Be sure to insert the batteries with the polarities (+, -) in the correct position.

If the batteries are incorrectly inserted, battery fluid may leak and damage the floor. (If you do not intend to use this monitor for a long period of time, it is advisable to remove the batteries before storage.)

Do not use the monitor near other products such as microwave ovens that emit electromagnetic waves.

Doing so may cause the monitor to malfunction, preventing accurate measurements.

Another person should assist persons with disabilities who may not be able to take a measurement alone.

Features and Functions

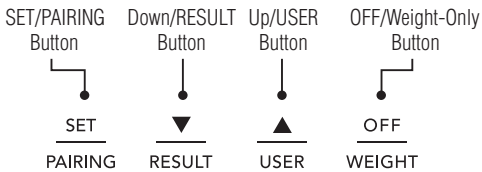
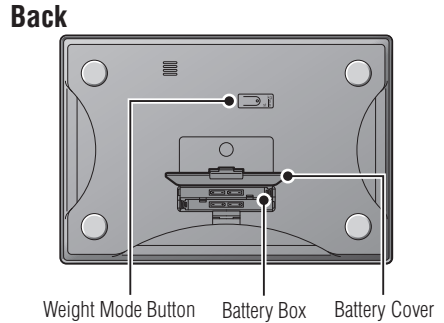
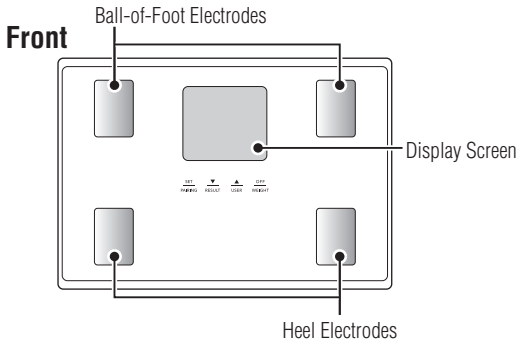

Accessories

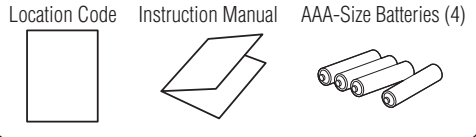

Preparations Before Use

Inserting the Batteries

Open the battery cover on the back of the measuring platform. Insert the supplied AAA-batteries as indicated.

Note: Be sure that the polarity of the batteries is set properly. If the batteries are incorrectly positioned the fluid may leak and damage floors. If you do not intend to use this unit for a long period of time, it is advisable to remove the batteries before storage.

Please note that the included batteries from factory may have decreased energy levels over time.

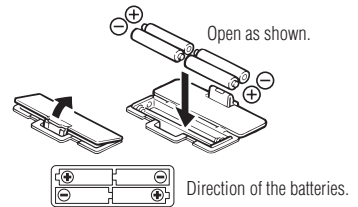

⚠ Positioning the Monitor

Place the measuring platform on a hard, flat surface where there is minimal vibration to ensure safe and accurate measurement.

Note: To avoid possible injury, do not step on the edge of the platform.



⚠ Handling Tips

This monitor is a precision instrument utilizing state-of-the-art technology. To keep the unit in the best condition, follow these instructions carefully:

- Do not attempt to disassemble the measuring platform.
- Store the unit horizontally, and place it so that the buttons will not be pressed accidentally.
- Avoid excessive impact or vibration to the unit.
- Place the unit in an area free from direct sunlight, heating equipment, high humidity, or extreme temperature change.
- Never submerge in water. Use alcohol to clean the electrodes and glass cleaner (applied to a cloth first) to keep them shiny; avoid soaps.
- Do not step on the platform when wet.
- Do not drop any objects onto the platform.
- Do not jump onto or off the unit.

Changing the Weight Mode

Note: For use only with models containing the weight mode button.

You can change the weight unit by using the button on the back of the scale.

Press the OFF button when the display is blank. When  appears in the screen, press the Weight Mode button on the underside of the unit to switch the unit in which weight is displayed.

Note: If weight mode is set to pounds or stone-pounds, the height programming mode will be automatically set to feet and inches. Similarly, if kilograms is selected, height will be automatically set to "cm".

Automatic Shut-Down Function

The automatic shut-down function shuts off the power automatically in the following cases:

- If you interrupt the measurement process. The power will shut down automatically within 30 seconds, depending upon the type of operation.
- During programming, if you do not touch any of the keys or buttons within 60 seconds.
- After you have completed the measuring process.

Getting Accurate Readings

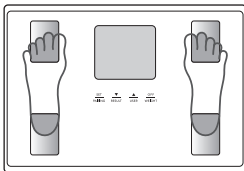

Heels centred on electrodes

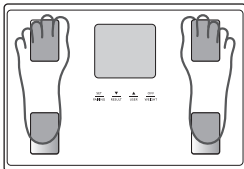

Toes may overhang measuring platform

To ensure accuracy, readings should be taken without clothing and under consistent conditions of hydration. If you do not undress, always remove your socks or stockings, and be sure the soles of your feet are clean before stepping on the measuring platform.

Be sure that your heels are correctly aligned with the electrodes on the measuring platform. Don't worry if your feet appear too large for the unit - accurate readings can still be obtained if your toes overhang the platform.

It is best to take readings at the same time of day. Try to wait about three hours after rising, eating, or hard exercise before taking measurements.

While readings taken under other conditions may not have the same absolute values, they are accurate for determining the percentage of change as long as the readings are taken in a consistent manner. To monitor progress, compare weight and body fat percentage taken under the same conditions over a period of time.

Note: An accurate reading will not be possible if the soles of your feet are not clean, or if your knees are bent or you are in a sitting position.

Initial Setup (Type 1) Setup via Smartphone

1. Turn the Bluetooth® setting on and download the "Health Planet" app.



iPhone 4S (of higher)/Android™ 4.4 (or higher) *Bluetooth Low Energy supported

Apple, the Apple logo, and iPhone are trademarks of Apple Inc.

Google Play and the Google Play logo are trademarks of Google LLC. Android is a trademark of Google LLC.

The Bluetooth® word mark and logos are registered trademarks owned by Bluetooth SIG, Inc. and any use of such marks by TANITA Corporation is under license.

Note: If you are not using an app, enter settings manually in the Body Composition Monitor (P.10) before using.

If you purchase a new smartphone, be sure to adjust the registration of your Body Composition Monitor accordingly.

Approximate signal range: 5 m in areas without obstructions



2. Launch the app. You need to register as a member to use the Health Planet app.
After registering, login with your registered details.

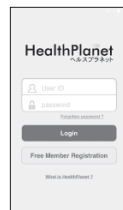

3. Select "Input Data", then select "Input from BCM".
select "BC-402" in the next screen.

Note: When taking measurements while holding your smartphone, enter the weight that you want to subtract into the "Smartphone's weight" section in the dedicated app before taking measurements.



4. Check the Body Composition Monitor is off, and tap the "Add Device" button.
Follow the instructions in the app.

Note: Compatible apps may be changed or added, in which case screen displays and operation methods will vary accordingly. Contact tanita.asia with any questions or concerns.

The screen displays and instructions may differ depending on the app specifications.



5. Operate the Body Composition Monitor as indicated by the app.
If the Body Composition Monitor is not powered on, press and hold the SET button for 3 seconds or more, then enter your information as indicated by the app.

Note: Depending on signal strength, it may take a few seconds to connect to the Body Composition Monitor.

The  icon is lit while data is being transmitted.

To weigh yourself while holding a smartphone, first enter the amount of weight you want to subtract into "Weight of Clothing, etc." The input amount will be subtracted from your weight display.

If 0.20 kg is entered into "Weight of Clothing, etc.," the following will be displayed before a measurement is taken.

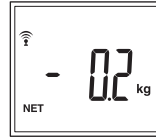

Display before measurement

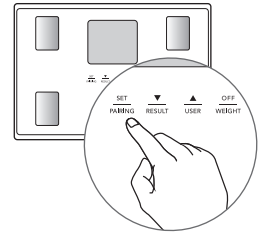

6. When the Body Composition Monitor is activated,  is displayed.

7. After  is displayed, carefully step barefoot onto the measuring platform.

Note: Please refrain from moving during measurement.

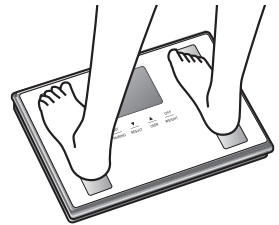

Registration of your body monitor is completed once measurement is completed.

Initial Setup (Type 2) from Body Composition Monitor

If the BC-402 is already paired with a smartphone, the location, date and time are already set so please skip this procedure. You may begin taking measurements right away.

Different locations across the world have different gravitational pulls. These differences affect the accuracy of the weight measurement. You can obtain the most accurate weight readings by selecting the correct gravity setting on the scale according to your geographical location.

1. Set your location code

When the power is off, press the SET, ▼ or ▲ button.
Refer to the map enclosed, and press the ▼ or ▲ button to select your location code.
Press the SET button to enter and save the setting.

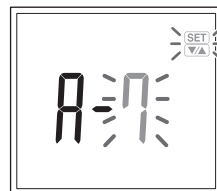

2. Set Date

Press the ▼ or ▲ button to set year and then press the SET button.
Set the month and date in the same way.



3. Set Hour

Press the ▼ or ▲ button to set hour and then press the SET button.



4. Set Minute

Press the ▼ or ▲ button to set minute and then press the SET button.

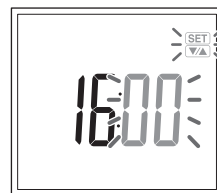

The device automatically turns off after the date and time are registered.

Note: 60 seconds or more of inactivity will cause automatic shut off during this process. No data will be saved as a result.

If you make a mistake or wish to turn the unit off before you complete the programming, press the OFF button to turn the unit off. Settings will not be saved in this case.

To change your location code, press and hold the OFF button for 3 seconds when the power is off, and then follow the procedure above to change your location code.

To change the date or time settings, press and hold the ▼ button for 3 seconds when the power is off, and then follow the procedure above to change the date or time settings.

You can fast-forward numbers if you keep holding down the ▼ or ▲ button.

When you replace batteries, press the SET, ▼ or ▲ button and then follow the above steps 2 to 4.

Taking Measurements

1. When the monitor power is off, select "Input Data" in the app and then follow the instructions in the app.
When 0.0 kg (0.0 lb, 0.0 stlb) is displayed, step onto the monitor.

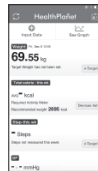

2. Measurement data is automatically sent to the smartphone.
If there is unsent data stored on the monitor, that data is also sent to the smartphone.



Note: When taking measurements while holding your smartphone, enter the weight that you want to subtract into the "Smartphone's weight" section in the dedicated app before taking measurements.

The weight that you entered to be subtracted from your weight is displayed.

The "Smartphone's weight" can be entered up to -2.0 kg (-4.4 lb, -4 lb).

The maximum weight (weighing capacity) is reduced by the amount entered for the "Smartphone's weight".

If you do not have your smartphone when taking measurements.

Simply step onto the monitor. The auto-recognition feature will automatically recall your personal data. Your monitor will store up to 10 sets of measurements. Saved data is sent to the smartphone together with new measurements the next time the smartphone is connected to the monitor when taking measurements.

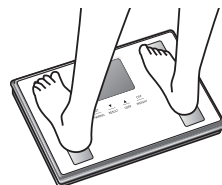

Note: Up to 10 measurements can be stored in the device per ID number.

Each new data entered after this amount causes the oldest data to be deleted.

 will notify you if pairing is complete and there is unsent data.

Setting and Storing Personal Data in Memory

The unit can be operated only if data has been programmed into one of the personal data memories.

1. Turn on the Power

Press the SET button to turn on the unit.

The unit will beep to confirm activation, the Personal data number will be displayed, and the display will flash.

Note: If you don't operate the unit for 60 seconds after the unit has been turned on, the unit will turn off automatically.

If you make a mistake or want to turn the unit off before you have finished programming it, press the OFF button to force quit.

2. Select a Personal data Number

Press the ▼ or ▲ button to select a Personal data number (1, 2, 3, 4 and 5). Once you reach the Personal data number you wish to use, press the SET button. The unit will beep once to confirm.

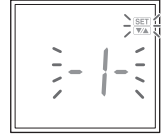

3. Set your Birthday

Set the date of your birthday (Year/Month/Day) using the ▼ or ▲ button. Press the SET button to confirm at each programming. The unit will beep once to confirm.

Note: Year settings can be configured from 1900 onwards.

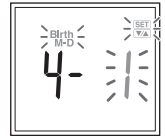

4. Select Female or Male

Use the ▼ or ▲ button to scroll through Female (♀) or Male (♂), Female/Athlete (♀🏃) and Male/Athlete (♂🏃) settings, then press the SET button. The unit will beep once to confirm.

Who should use Athlete Mode?

Adults aged 18 years and over who either:

- Train or exercise for 12 hours or more a week and have been doing so for at least six months.
- Are body builders.
- Are professional athletes who want to monitor their progress at home.
- Have a lifetime history of fitness and who used to do more than 12 hours a week but do less now.



5. Specify the Height

The display defaults to 170 cm (5' 7.0") (range of height is from 90 cm – 220 cm or 3' 0.0" – 7' 3.0"). Use the ▼ or ▲ button to specify Height and then press the SET button. The unit will beep once to confirm, and then the display shows 00 kg and is ready for measurement.



6. Measuring your weight and body fat

Step onto the scale after 00 kg is shown on the display within 60 seconds.

Do not step off until "0000" disappears.

The readings will be shown for 40 seconds.

The unit will then shut off and the readings will be stored in the memory.



Note: If you step onto the scale before 00 kg appears the display will show Err and you will not obtain a reading. Furthermore, if you do not step onto the measuring scale within about 60 seconds after 00 kg appears, the power is shut-off automatically. Please try the setting and storing personal data process again.

Warning

Do not use the body fat reading feature of this product if you have a pacemaker or other implanted electronic medical device.

Taking Weight and Body Fat Readings

After programming your personal data you are ready to take a reading.

1. Step onto the scale

Step onto the scale while the scale is off, the scale turns on automatically and starts measuring.

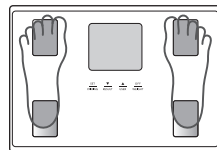

2. Get Your Readings

After the measurement is taken, readings will be automatically displayed in the order listed below.

After the last result reading is displayed, the weight reading will again appear, then the unit will automatically shut off.

The user may use the ▼ button to scroll through the different results.

For advanced scrolling, the user may press and hold the ▼ button until the required reading is displayed. Release the button to view the result and readings will appear for 40 seconds before the unit automatically shuts off.

Note: Do not step off until “J-J / C-C” disappears.

If the wrong personal number appears on the display

You can change the personal number by using the ▲ button.

Press the ▲ or ▼ button until your personal number and profile appears.

After you select your correct personal number and press the SET button, the display will show your correct readings automatically.

The results will be stored in the memory under your personal number.

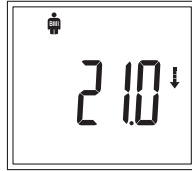
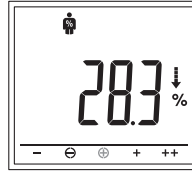
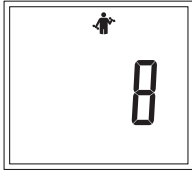
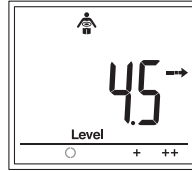
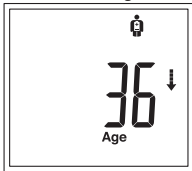
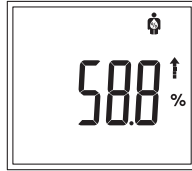
1. Weight**2. BMI****3. Body Fat %****4. Muscle mass****5. Physique Rating****6. Bone mass****7. Visceral fat****8. BMR****9. Metabolic Age****10. Total Body Water %**

| | - | ⊖ | ○ | ⊕ | + | ++ |
|--------------------------------|-------|------------|---------|------------|---------------|-------|
| Body Fat Percentage Assessment | Under | Standard - | | Standard + | Over | Obese |
| Muscle Mass Assessment | Under | | Average | | High | |
| Bone Mass Assessment | Under | Standard - | Average | | High | |
| Visceral Fat Level Assessment | | | Average | | Slightly high | High |
| BMR Assessment | Low | | Average | | High | |

↑ → ↓ Arrows indicate the trend compared to the previous time that a measurement was taken.

Note: For children (age 5-17), the monitor only displays weight, BMI, Body Fat %.

"Err" is displayed if the body fat percentage exceeds the measurable range.

You can use the ▼ button to scroll through the results.

Press and hold the ▼ button for fast scrolling. After reading the results that you want to see, release the button to see the rest of the results.

Press the OFF button to cancel measurement or turn the power off.

Do not move the monitor for approximately 3 seconds after taking measurements and stepping off.

To prevent accidents such as falling off the monitor, always step off the monitor before operating the buttons.

Programming the Guest Mode

Guest mode allows you to program the unit for a one-time use without reading a personal data number.

Press the ▲ button to activate the unit. Press the ▼ or ▲ button to select -0-. Press the SET button. Then follow the steps: Set the age, gender (male/female/male athlete/female athlete) and height. Step onto the scale after 00.0 is shown on the display. Your weight will be shown first, continue standing on the scale until the body fat % reading is shown on the display. The reading will be shown for 40 seconds.

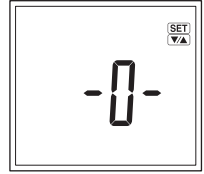

Note: Do not step off until “0000” disappears.

Note: If you step onto the scale before 00.0 appears the display will show Err and you will not obtain readings.

Taking Weight Measurement Only

Press the OFF button. Step onto the scale after 00.0 is shown on the display. The body weight value will appear. The display will light for about 20 seconds, and then the power will automatically turn off.

Changing Personal Data

1. When the power is off, press the SET button.
2. Press the ▼ or ▲ button to select a personal data number (1, 2, 3, 4 and 5). Once you reach the personal data number you wish to use, press the SET button. The unit will beep once to confirm.
3. Follow the steps as listed on P.12 to change your personal data.

Note: If you change the birthday and/or gender, the unit will show Err.

If you select YES using the ▼ or ▲ button and pressing the SET button to confirm, the existing personal data will be deleted.

If you select no using the ▼ or ▲ button and pressing the SET button to confirm, no new data will be saved (existing data will be unchanged) then the unit will shut off.

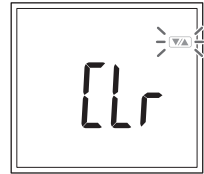

Erasing Personal Data

1. When the power is off, press and hold the SET button.
2. Press the ▼ or ▲ button to select a personal data number (1, 2, 3, 4 and 5). Once you reach the personal data number you wish to use, press the SET button for more than 3 seconds. The unit will beep once to confirm. Err is displayed.
3. Select YES using the ▼ or ▲ button.
4. Press the SET button.

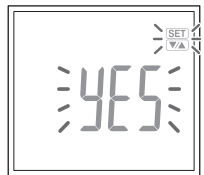

Troubleshooting

If the following problems occur ... then...

- **A wrong weight format appears followed by kg, lb, or st-lb.**
Refer to "Changing the weight mode" on P.7.
- **LD appears on the display, or all the data appears and immediately disappears.**
Batteries are low. When this message appears, be sure to replace the batteries immediately, since weak batteries will affect the accuracy of your measurements. Change all the batteries at the same time with new AAA-size batteries.
Note: Your settings will not be erased from the memory when you remove the batteries.
- **Err appears while measuring.**
Please stand on the platform keeping movement to a minimum. The unit cannot accurately measure your weight if it detects movement.
When the Body Fat % is more than 75%, readings cannot be obtained from the unit.
When the BMI is less than 5, readings cannot be obtained from the unit.
- **The Body Fat Percentage measurement does not appear.**
Your personal data has not been programmed. Follow the steps on P.12.
Make sure socks or stockings are removed, and the soles of your feet are clean and properly aligned with the guides on the measuring platform.
- **OL appears while measuring.**
Reading cannot be obtained if the weight capacity is exceeded.
- **-OL appears on the display.**
Did you step onto the Body Composition Monitor before \overline{OL} was displayed?
- **Errb is displayed.**
Please set the correct date and time.
When not in use, the Body Composition Monitor will periodically calibrate in preparation for the next weighing. If the unit has been stored horizontally, with items placed on top or moved from one location to another, select your personal data number as explained on p.12 prior to taking your measurement.

Cannot connect my smartphone to the Body Composition Monitor

- **ErrP or Errd appears on the display**
Are batteries inserted correctly in the Body Composition Monitor?
Are the batteries running low?
Are the smartphone and body composition meter within communication range?
The communication range for The Body Composition Monitor is 5 m in an unobstructed location.
Is the "Bluetooth" setting in the smartphone "Settings" turned on?
- **ErrP appears repeatedly.**
Delete the pairing information from "Settings" > "Bluetooth" on the smartphone, and pair the smartphone with the Body Composition Monitor again.
- **ErrU appears repeatedly.**
Delete the pairing information from "Settings" > "Bluetooth" on the smartphone, and pair the smartphone with the Body Composition Monitor again.
- **ErrG appears on the display**
Remove and replace the batteries from the Body Composition Monitor, and set the date and time again.
- **The date and time settings have been changed**
When using the Body Composition Monitor linked with a smartphone, the date and time settings on the Body Composition Monitor are overwritten with those from the smartphone.
- **The "Input Data" button in the app does not work**
Is the "Bluetooth" setting in the smartphone "Settings" turned on?
Linking between the app and the Body Composition Monitor is only enabled when the Body Composition Monitor is turned off.
Check that the power of the Body Composition Monitor is turned off and try again.

Specifications

BC-402

Weight Capacity

150 kg (330 lb) (23 st 8 lb)

Weight Increments

0 – 150 kg/0.1 kg (0 – 330 lb/0.2 lb) (0 – 23 st 8 lb/0.2 lb)

Body Fat %

5 – 99 years old *1

Body Mass Index

5 – 99 years old

Muscle Mass

18 – 99 years old *1

Physique Rating

18 – 99 years old

Bone Mass

18 – 99 years old *1

Visceral Fat

18 – 99 years old *1

Basal Metabolic Rate

18 – 99 years old *1

Metabolic Age

18 – 99 years old

Total Body Water %

18 – 99 years old

Personal Data

5 memories

Power Supply

4 AAA alkaline batteries (included)

Power Consumption

50 mA maximum

Measuring Current

50 kHz, 6.25 kHz, 100 µA

Communication Method

Bluetooth Low Energy technology

Frequency Band

2402 – 2480 MHz

*1 When age exceeds 99 years old, it is just for reference.

Manufacturer TANITA Corporation

1-14-2 Maeno-cho, Itabashi-ku,
Tokyo 174-8630 Japan
TEL: +81-(0)3-3968-7048
www.tanita.co.jp

TANITA Health Equipment H.K. Ltd.

Unit 301-303, Wing On Plaza, 3/F., 62 Mody
Road,
Tsimshatsui East, Kowloon, Hong Kong
TEL: +852-2834-3917
FAX: +852-2838-8667
www.tanita.asia

EU Representative TANITA Europe B.V.

Hoogoorddreef 56-E, 1101 BE
Amsterdam, the Netherlands
TEL: +31-(0)20-560-2970
FAX: +31-(0)20-560-2988
www.tanita.eu

TANITA (Shanghai) Trading Co., Ltd.

Room 8005, 877 Huai Hai Zhong Lu,
Shanghai,
The People's Republic of China
TEL: +86-21-6474-6803
FAX: +86-21-6474-7901

TANITA Corporation of America, Inc.

2625 South Clearbrook Drive,
Arlington Heights, Illinois 60005
U.S.A.
TEL: +1-847-640-9241
FAX: +1-847-640-9261
www.tanita.com

TANITA India Private Limited

A-502, Mittal Commercial,
Off. M.V. Road (Andheri Kurla Road),
Marol, Andheri-East, Mumbai 400059,
Maharashtra, India
TEL: +91-81-697-28173
www.tanita.co.in

Disposal



This is an electronic device.

Please dispose of it as an electronic device, not as general household waste. Please follow the regulations in your local region when disposing of this device.



⚠ Not allowed to mix batteries with consumer wastes!

As consumer you are legally bound to return used or discharged batteries. You can deposit your old batteries at the public collecting points in your town, or wherever the corresponding batteries are sold and specifically marked collecting boxes have been set up. In case of scrapping the apparatus, the batteries should be removed from it and deposited at the collecting points as well.



- The product design and specifications may be changed at any time without prior notice.
- The Bluetooth® word mark and logos are registered trademarks owned by Bluetooth SIG, Inc. and any use of such mark by TANITA Corporation is under licence.
- Android is a trademark of Google LLC.
- iPhone is a trademark of Apple Inc.