

FTB-7000 Series

OTDR for FTB-200 v2



Copyright © 2006–2011 EXFO Inc. All rights reserved. No part of this publication may be reproduced, stored in a retrieval system or transmitted in any form, be it electronically, mechanically, or by any other means such as photocopying, recording or otherwise, without the prior written permission of EXFO Inc. (EXFO).

Information provided by EXFO is believed to be accurate and reliable. However, no responsibility is assumed by EXFO for its use nor for any infringements of patents or other rights of third parties that may result from its use. No license is granted by implication or otherwise under any patent rights of EXFO.

EXFO's Commerce And Government Entities (CAGE) code under the North Atlantic Treaty Organization (NATO) is 0L8C3.

The information contained in this publication is subject to change without notice.

Trademarks

EXFO's trademarks have been identified as such. However, the presence or absence of such identification does not affect the legal status of any trademark.

Units of Measurement

Units of measurement in this publication conform to SI standards and practices.

Patents

EXFO's Universal Interface is protected by US patent 6,612,750.

Version number: 17.0.6

Contents

Certification Information	viii
1 Introducing the Optical Time Domain Reflectometer	1
Main Features	3
Trace Acquisition Modes	4
Optional Software Packages	4
Data Post-Processing	4
Bidirectional Analysis Application	5
Available OTDR Models	5
OTDR Basic Principles	8
Conventions	10
2 Safety Information	11
Laser Safety Information (Models without VFL)	11
Laser Safety Information (Models with VFL)	12
3 Getting Started with Your OTDR	13
Inserting and Removing Test Modules	13
Starting Module Applications	19
Timer	20
4 Preparing Your OTDR for a Test	21
Installing the EXFO Universal Interface (EUI)	21
Cleaning and Connecting Optical Fibers	22
Naming Trace Files Automatically	24
Enabling or Disabling the First Connector Check	28
Setting Macrobend Parameters	29
Launch Conditions for Multimode Measurements	31
5 Testing Fibers in Auto Mode	33
6 Testing Fibers in Advanced Mode	37
Setting the Autorange Acquisition Time	42
Setting the IOR, RBS Coefficient, and Helix Factor	43
Setting Distance Range, Pulse Width, and Acquisition Time	45
Enabling the High-Resolution Feature	49
Enabling or Disabling Analysis After Acquisition	51
Setting Pass/Fail Thresholds	53
Setting a Default Span Start and Span End	58

Contents

7 Testing Fibers in Template Mode	61
Template Principle	61
Restrictions of Template Mode	62
Acquiring the Reference Trace	64
Acquiring Traces in Template Mode	66
Selecting a Reference Trace	74
8 Testing Fibers in Fault Finder Mode	75
Acquiring Traces in Fault Finder Mode	75
Naming Fault Finder Files Automatically	78
Selecting the Default File Format for the Fault Finder Traces	80
Enabling or Disabling the Confirmation of Fault Finder File Name	82
Enabling or Disabling the Storage Feature	84
Enabling or Disabling the First Connector Check for Fault Finder	85
Enabling or Disabling the Touchscreen Keyboard	87
Setting Trace Display Parameters	88
Selecting the Distance Units	90
9 Customizing Your OTDR	93
Selecting the Default File Format	93
Enabling or Disabling File Name Confirmation	94
Selecting the Distance Units	96
Customizing the Acquisition Distance Range Values	98
Customizing the Acquisition Time Values	100
Enabling or Disabling the Touchscreen Keyboard	102
Displaying or Hiding the Optional Features	103

10 Analyzing Traces and Events	105
Graph View	106
Linear View	108
Summary Table	110
Events Tab	112
Measure Tab	116
Trace Info. Tab	116
Displaying the Graph in Full Screen	117
Selecting the Default View	119
Automatically Displaying the Event Table after Acquisitions	121
Automatically Zooming in on the Fiber Span	122
Using Zoom Controls	123
Setting Trace Display Parameters	126
Customizing the Event Table	128
Displaying or Hiding a Trace	130
Clearing Traces from the Display	132
Viewing and Modifying Current Trace Settings	133
Modifying Events	138
Inserting Events	142
Deleting Events	144
Changing the Attenuation of Fiber Sections	146
Setting the Analysis Detection Thresholds	148
Analyzing or Reanalyzing a Trace	151
Analyzing the Fiber on a Specific Fiber Span	153
Enabling or Disabling the Detection of Reflective Ends of Fiber	154
Swapping Traces	158
Opening Trace Files	159
11 Analyzing the Results Manually	163
Selecting the Attenuation and Loss Values that Will Be Displayed	163
Using Markers	165
Getting Event Distances and Relative Powers	166
Getting Event Loss (Four-Point and Least-Square Approximation)	167
Getting Attenuation (Two-Point and Least-Square Approximation)	172
Getting Reflectance	174
Getting Optical Return Loss (ORL)	175
12 Managing Trace Files from the OTDR Test Application	177
Saving a Trace in a Different Format	177
OTDR Trace File Compatibility	178
Copying, Moving, Renaming, or Deleting Trace Files	180

Contents

13 Creating Reports	181
Adding Information to the Test Results	181
Generating a Report	183
14 Using the OTDR as a Light Source or VFL	189
15 Analyzing Traces with the Bidirectional Analysis Application	193
Starting and Exiting the Bidirectional Analysis Application	195
Creating Bidirectional Measurement Files	197
Opening Existing Bidirectional Measurement Files	201
Displaying Traces and Bidirectional Measurement	202
Viewing Results	204
Reanalyzing Traces and Regenerating the Bidirectional Measurement	215
Modifying the Alignment of Unidirectional Traces	217
Using Zoom Controls	221
Using Markers to Edit Events	225
Inserting Events	227
Modifying Events	231
Deleting Events	235
Changing the Attenuation of Fiber Sections	237
Setting General Parameters	240
Customizing the Events Table	243
Saving the Span-Start and Span-End Information	246
Setting Pass/Fail Thresholds	247
Modifying Trace Analysis Settings	252
Saving Traces	257
Exporting Unidirectional Traces from Bidirectional Files	259
Adding Information to the Test Results	261
Creating Reports	263
16 Maintenance	267
Cleaning EUI Connectors	268
Verifying Your OTDR	270
Recalibrating the Unit	278
Recycling and Disposal (Applies to European Union Only)	279
17 Troubleshooting	281
Contacting the Technical Support Group	284
Transportation	285

18 Warranty	287
General Information	287
Liability	288
Exclusions	288
Certification	288
Service and Repairs	289
EXFO Service Centers Worldwide	290
A Technical Specifications	291
B Description of Event Types	297
Span Start	298
Span End	298
Short Fibers	298
Continuous Fiber	299
End of Analysis	300
Non-Reflective Event	301
Reflective Event	302
Positive Event	303
Launch Level	304
Fiber Section	305
Merged Event	306
Echo	312
Reflective Event (Possible Echo)	313
Index	315

Certification Information

FCC Information

Electronic test equipment is exempt from Part 15 compliance (FCC) in the United States. However, compliance verification tests are systematically performed on most EXFO equipment.

CE Information

Electronic test equipment is subject to the EMC Directive in the European Union. The EN61326 standard prescribes both emission and immunity requirements for laboratory, measurement, and control equipment. This unit has undergone extensive testing according to the European Union Directive and Standards.



IMPORTANT

Use of shielded remote I/O cables, with properly grounded shields and metal connectors, is recommended in order to reduce radio frequency interference that may emanate from these cables.

EXFO **CE** **DECLARATION OF CONFORMITY**

Application of Council Directive(s):	2006/95/EC - The Low Voltage Directive 2004/108/EC - The EMC Directive 2006/66/EC - The Battery Directive 93/68/EEC - CE Marking And their amendments
Manufacturer's Name:	EXFO Inc.
Manufacturer's Address:	400 Godin Avenue Quebec, Quebec Canada, G1M 2K2 (418) 683-0211
Equipment Type/Environment: Trade Name/Model No.:	Test & Measurement / Industrial LAN / WAN ACCESS OTDR / FTB-7200D

Standard(s) to which Conformity is Declared:

EN 61010-1:2001 Edition 2.0	Safety Requirements for Electrical Equipment for Measurement, Control, and Laboratory Use, Part 1: General Requirements.
EN 61326-1:2006	Electrical Equipment for Measurement, Control and Laboratory Use - EMC Requirements – Part 1: General requirements
EN 60825-1:2007 Edition 2.0	Safety of laser products – Part 1: Equipment classification, requirements, and user's guide
EN 55022: 2006 + A1: 2007	Information technology equipment - Radio disturbance characteristics - Limits and methods of measurement

I, the undersigned, hereby declare that the equipment specified above conforms to the above Directive and Standards.

Manufacturer

Signature:



Full Name: Stephen Bull, E. Eng
Position: Vice-President Research and Development
Address: 400 Godin Avenue, Quebec (Quebec),
Canada, G1M 2K2
Date: January 09, 2009

Certification Information

EXFO **CE** DECLARATION OF CONFORMITY

Application of Council Directive(s):	2006/95/EC - The Low Voltage Directive 2004/108/EC - The EMC Directive 2006/66/EC - The Battery Directive 93/68/EEC - CE Marking And their amendments
Manufacturer's Name:	EXFO Inc.
Manufacturer's Address:	400 Godin Avenue Quebec, Quebec Canada, G1M 2K2 (418) 683-0211
Equipment Type/Environment:	Test & Measurement / Industrial
Trade Name/Model No.:	FTTx-PON / MDU OTDR / FTB-7300E

Standard(s) to which Conformity is Declared:

EN 61010-1:2001 Edition 2.0	Safety Requirements for Electrical Equipment for Measurement, Control, and Laboratory Use, Part 1: General Requirements.
EN 61326-1:2006	Electrical Equipment for Measurement, Control and Laboratory Use - EMC Requirements – Part 1: General requirements
EN 60825-1:2007 Edition 2.0	Safety of laser products – Part 1: Equipment classification, requirements, and user's guide
EN 55022: 2006 + A1: 2007	Information technology equipment - Radio disturbance characteristics - Limits and methods of measurement

I, the undersigned, hereby declare that the equipment specified above conforms to the above Directive and Standards.

Manufacturer

Signature:



Full Name: Stephen Bull, E-Eng
Position: Vice-President Research and Development
Address: 400 Godin Avenue, Quebec (Quebec),
Canada, G1M 2K2
Date: January 09, 2009

EXFO **CE** **DECLARATION OF CONFORMITY**

Application of Council Directive(s):	2006/95/EC - The Low Voltage Directive 2004/108/EC - The EMC Directive 2006/66/EC - The Battery Directive 93/68/EEC - CE Marking And their amendments
Manufacturer's Name:	EXFO Inc.
Manufacturer's Address:	400 Godin Avenue Quebec, Quebec Canada, G1M 2K2 (418) 683-0211
Equipment Type/Environment: Trade Name/Model No.:	Test & Measurement / Industrial METRO / CWDM OTDR / FTB-7400E

Standard(s) to which Conformity is Declared:

EN 61010-1:2001 Edition 2.0	Safety Requirements for Electrical Equipment for Measurement, Control, and Laboratory Use, Part 1: General Requirements.
EN 61326-1:2006	Electrical Equipment for Measurement, Control and Laboratory Use - EMC Requirements – Part 1: General requirements
EN 60825-1:2007 Edition 2.0	Safety of laser products – Part 1: Equipment classification, requirements, and user's guide
EN 55022: 2006 + A1: 2007	Information technology equipment - Radio disturbance characteristics - Limits and methods of measurement

I, the undersigned, hereby declare that the equipment specified above conforms to the above Directive and Standards.

Manufacturer

Signature:



Full Name: Stephen Bull, E-Eng
Position: Vice-President Research and Development
Address: 400 Godin Avenue, Quebec (Quebec),
Canada, G1M 2K2
Date: January 09, 2009

Certification Information

EXFO **CE** **DECLARATION OF CONFORMITY**

Application of Council Directive(s): 2006/95/EC - The Low Voltage Directive
2004/108/EC - The EMC Directive
2006/66/EC - The Battery Directive
93/68/EEC - CE Marking
And their amendments

Manufacturer's Name: EXFO Inc.
Manufacturer's Address: 400 Godin Avenue
Quebec, Quebec
Canada, G1M 2K2
(418) 683-0211

Equipment Type/Environment: Test & Measurement / Industrial
Trade Name/Model No.: METRO / LONG-HAUL OTDR / FTB-7500E

Standard(s) to which Conformity is Declared:

EN 61010-1:2001 Edition 2.0 Safety Requirements for Electrical Equipment for Measurement, Control, and Laboratory Use, Part 1: General Requirements.

EN 61326-1:2006 Electrical Equipment for Measurement, Control and Laboratory Use - EMC Requirements – Part 1: General requirements

EN 60825-1:2007 Edition 2.0 Safety of laser products – Part 1: Equipment classification, requirements, and user's guide

EN 55022: 2006 + A1: 2007 Information technology equipment - Radio disturbance characteristics - Limits and methods of measurement

I, the undersigned, hereby declare that the equipment specified above conforms to the above Directive and Standards.

Manufacturer

Signature:



Full Name: Stephen Bull, E-Eng
Position: Vice-President Research and Development
Address: 400 Godin Avenue, Quebec (Quebec),
Canada, G1M 2K2
Date: January 09, 2009

EXFO **CE** **DECLARATION OF CONFORMITY**

Application of Council Directive(s): 2006/95/EC - The Low Voltage Directive
2004/108/EC - The EMC Directive
2006/66/EC - The Battery Directive
93/68/EEC - CE Marking
And their amendments

Manufacturer's Name: EXFO Inc.
Manufacturer's Address: 400 Godin Avenue
Quebec, Quebec
Canada, G1M 2K2
(418) 683-0211

Equipment Type/Environment: Test & Measurement / Industrial
Trade Name/Model No.: ULTRA-LONG-HAUL OTDR / FTB-7600E

Standard(s) to which Conformity is Declared:

- EN 61010-1:2001 Edition 2.0** Safety Requirements for Electrical Equipment for Measurement, Control, and Laboratory Use, Part 1: General Requirements.
- EN 61326-1:2006** Electrical Equipment for Measurement, Control and Laboratory Use - EMC Requirements – Part 1: General requirements
- EN 60825-1:2007 Edition 2.0** Safety of laser products – Part 1: Equipment classification, requirements, and user's guide
- EN 55022: 2006 + A1: 2007** Information technology equipment - Radio disturbance characteristics - Limits and methods of measurement

I, the undersigned, hereby declare that the equipment specified above conforms to the above Directive and Standards.

Manufacturer

Signature:



Full Name: Stephen Bull, E-Eng
Position: Vice-President Research and Development
Address: 400 Godin Avenue, Quebec (Quebec),
Canada, G1M 2K2
Date: January 09, 2009

1 Introducing the Optical Time Domain Reflectometer

The Optical Time Domain Reflectometer allows you to characterize a fiber-optic span, usually optical fiber sections joined by splices and connectors. The optical time domain reflectometer (OTDR) provides an inside view of the fiber, and can calculate fiber length, attenuation, breaks, total return loss, and splice, connector and total losses.

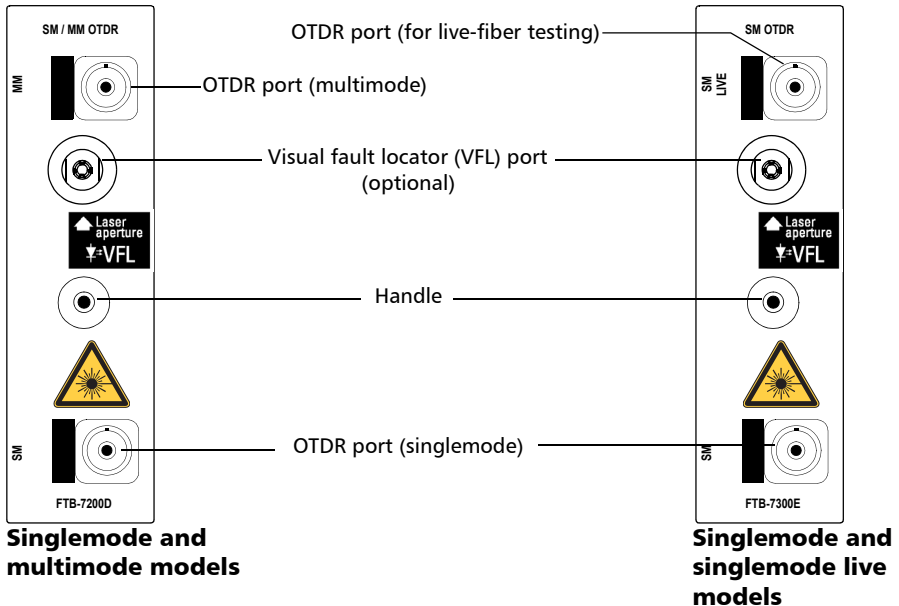

Introducing the Optical Time Domain Reflectometer

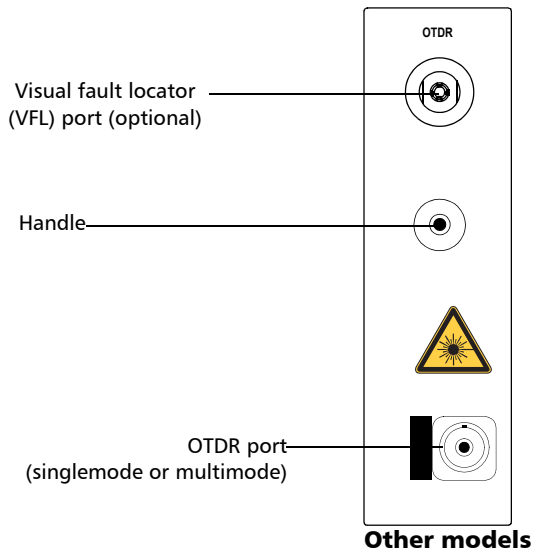

Main Features

The OTDR:

- Offers impressive dynamic range with short dead zones.
- Performs quick acquisitions with low noise levels to enable accurate low-loss splice location.
- Acquires OTDR traces made of up to 256 000 points that provide a sampling resolution as fine as 4 cm.
- Includes a light source and can include an optional visual fault locator.

Trace Acquisition Modes

The OTDR application provides the following trace acquisition modes:

- *Auto*: Automatically calculates fiber length, sets acquisition parameters, acquires traces, and displays event tables and acquired traces.
- *Advanced*: Offers all the tools needed to perform integral OTDR tests and measurements and gives you control over all test parameters.
- *Template (optional)*: Tests fibers and compares the results to a reference trace that was previously acquired and analyzed. This allows you to save time when testing a large number of fibers. Reference trace documentation is also automatically copied to new acquisitions.
- *Fault Finder*: Rapidly locates fiber ends and displays the length of the fiber under test. This allows you to perform quick tests without having to set all the acquisition parameters.

Optional Software Packages

An optional software package is offered with the application. With this package, you can find macrobends, view the related information. The software package also give you access to the “linear view”, which displays the events sequentially, from left to right.

Note: *Optional Software Packages were meant to function on FTB-200 v2 units and not on FTB-200 units.*

Data Post-Processing

You can install the OTDR Viewer (available on the CD that came with your product) on a computer to view and analyze traces without having to use an FTB-200 v2 Compact Modular Platform and an OTDR. You can also access more features such as:

- customized printout

- batch printing
- conversion of traces to many formats such as Telcordia or ASCII

Bidirectional Analysis Application

You can improve the accuracy of your loss measurements with the bidirectional analysis application. This utility uses OTDR acquisitions from both ends of a fiber span (*singlemode* traces only) to average loss results for each event.

Available OTDR Models

A wide variety of multimode and singlemode OTDR models is offered at several wavelengths to cover all fiber applications from long-haul or WDM networks to metropolitan networks.

OTDR Models	Description
Singlemode FTB-7200D-B	<ul style="list-style-type: none">➤ 1310 nm and 1550 nm.➤ 35 dB dynamic range and 1 m event dead zone, useful to locate closely spaced events.➤ High-resolution feature to obtain more data points per acquisition. Data points will be closer to each other, resulting in a greater distance resolution for the trace.

Introducing the Optical Time Domain Reflectometer

Available OTDR Models

OTDR Models	Description
Singlemode and multimode FTB-7200D-12CD-23B	<ul style="list-style-type: none"> ▶ Four wavelengths: two multimode (850 nm and 1300 nm) and two singlemode (1310 nm and 1550 nm) in a single module. ▶ 26 dB (850 nm)/25 dB (1300 nm)/35 dB (1310 nm)/34 dB (1550 nm) dynamic range and 1 m event dead zone, particularly useful to locate closely spaced events. ▶ 4.5 m of attenuation dead zone for both singlemode and multimode. ▶ Allows tests on both 50 μm (C type) and 62.5 μm (D type) multimode fibers.
Singlemode and singlemode live (SM Live) FTB-7300E-XXXXB	<ul style="list-style-type: none"> ▶ Optimized for metro network installation and troubleshooting, access and FTTx test applications (end-to-end links), and inside plant testing. ▶ Test through splitter for FTTH PON characterization. ▶ Live fiber out-of-band testing with filtered SM Live port at 1625 nm or 1650 nm. ▶ Attenuation and event dead zone of, respectively, 4 m and 0.8 m. ▶ 38 dB dynamic range.
Singlemode FTB-7400E-XXXXB	<ul style="list-style-type: none"> ▶ Attenuation dead zone of 4 m for pinpoint event location ▶ Up to 40 dB dynamic range with 0.8 m event dead zone. ▶ Acquires up to 256 000 data points while sampling a single trace. ▶ Up to four test wavelengths (1310 nm, 1383 nm, 1550 nm, 1625 nm) for CWDM and DWDM link characterization

Introducing the Optical Time Domain Reflectometer

Available OTDR Models

OTDR Models	Description
Singlemode FTB-7500E-XXXXB	<ul style="list-style-type: none">▶ Event dead zone of 0.8 m and attenuation dead zone of 4 m for pinpoint event location▶ Up to 45 dB dynamic range (on NZDSF with a 20 μs pulse)▶ High-launch power level minimizes noise effects on signal.▶ Acquires up to 256 000 data points while sampling a single trace.▶ Suitable for long-range applications and recommended when measuring time is a key factor.
Singlemode FTB-7600E-XXXXB	<ul style="list-style-type: none">▶ Up to 50 dB dynamic range (on NZDSF with a 20 μs pulse)▶ Event dead zone of 1.5 m and attenuation dead zone of 5 m with a 5 ns pulse for high resolution▶ Acquires up to 256 000 data points while sampling a single trace▶ Suitable for characterization of ultra long cables▶ Best in class analysis for accurate measurement of loss, reflectance and attenuation.

OTDR Basic Principles

An OTDR sends short pulses of light into a fiber. Light scattering occurs in the fiber due to discontinuities such as connectors, splices, bends, and faults. An OTDR then detects and analyzes the backscattered signals. The signal strength is measured for specific intervals of time and is used to characterize events.

The OTDR calculates distances as follows:

$$\text{Distance} = \frac{c}{n} \times \frac{t}{2}$$

where

- c = speed of light in a vacuum (2.998×10^8 m/s)
- t = time delay from the launch of the pulse to the reception of the pulse
- n = index of refraction of the fiber under test (as specified by the manufacturer)

An OTDR uses the effects of Rayleigh scattering and Fresnel reflection to measure the fiber's condition, but the Fresnel reflection is tens of thousands of times greater in power level than the backscatter.

- Rayleigh scattering occurs when a pulse travels down the fiber and small variations in the material, such as variations and discontinuities in the index of refraction, cause light to be scattered in all directions. However, the phenomenon of small amounts of light being reflected directly back toward the transmitter is called backscattering.
- Fresnel reflections occur when the light traveling down the fiber encounters abrupt changes in material density that may occur at connections or breaks where an air gap exists. A very large quantity of light is reflected, as compared with the Rayleigh scattering. The strength of the reflection depends on the degree of change in the index of refraction.

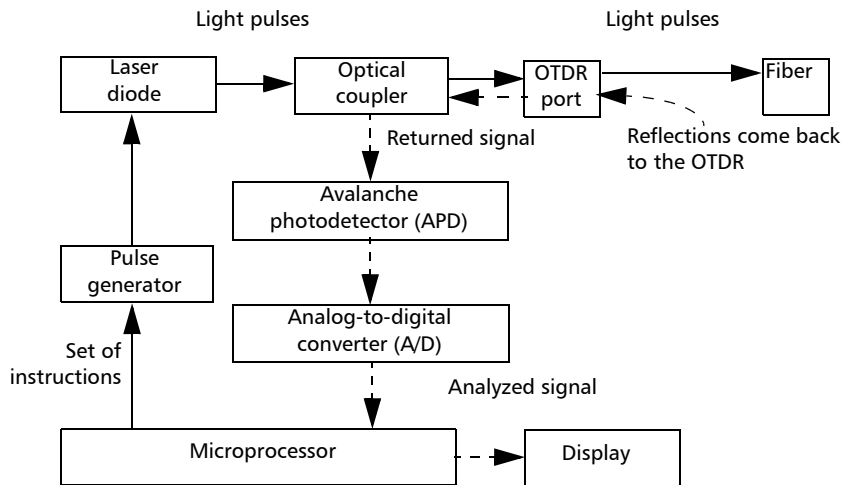

When the full trace is displayed, each point represents an average of many sampling points. You will have to zoom to see each point.

Conventions

Before using the product described in this manual, you should understand the following conventions:



WARNING

Indicates a potentially hazardous situation which, if not avoided, could result in *death or serious injury*. Do not proceed unless you understand and meet the required conditions.



CAUTION

Indicates a potentially hazardous situation which, if not avoided, may result in *minor or moderate injury*. Do not proceed unless you understand and meet the required conditions.



CAUTION

Indicates a potentially hazardous situation which, if not avoided, may result in *component damage*. Do not proceed unless you understand and meet the required conditions.



IMPORTANT

Refers to information about this product you should not overlook.

2 Safety Information



WARNING

Do not install or terminate fibers while a light source is active. Never look directly into a live fiber and ensure that your eyes are protected at all times.



WARNING

Use of controls, adjustments and procedures for operation and maintenance other than those specified herein may result in hazardous radiation exposure or impair the protection provided by this unit.

Laser Safety Information (Models without VFL)

Your instrument is a Class 1M laser product in compliance with standards IEC 60825-1 and 21 CFR 1040.10. Invisible laser radiation may be encountered at the output port.

The product is safe under reasonably foreseeable conditions of operation but it may be hazardous if you use optics within a diverging or collimated beam. *Do not view directly with optical instruments.*

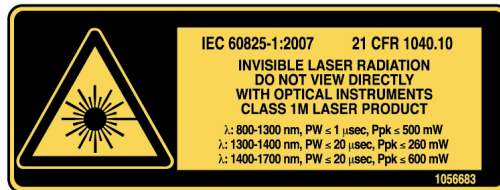

Affixed to module's side panel

Safety Information

Laser Safety Information (Models with VFL)

Laser Safety Information (Models with VFL)

Your instrument is a Class 3R laser product in compliance with standards IEC 60825-1 and 21 CFR 1040.10. It is potentially harmful in direct intrabeam viewing.

The following label(s) indicate that the product contains a Class 3R source:

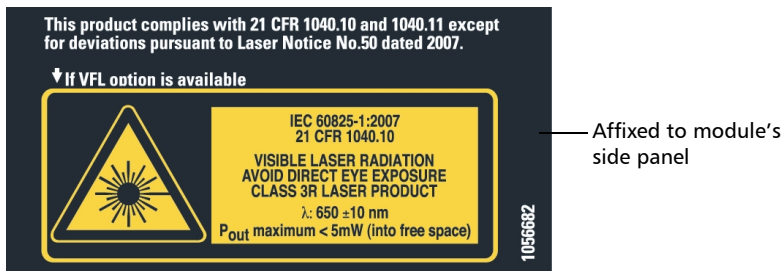

3 **Getting Started with Your OTDR**

Inserting and Removing Test Modules



CAUTION

Never insert or remove a module while the FTB-200 v2 Compact Modular Platform is turned on. This will result in immediate and irreparable damage to both the module and unit.



WARNING

When the laser safety LED is flashing, at least one of your modules is emitting an optical signal. Please check all modules, as it might not be the one you are currently using.

Getting Started with Your OTDR

Inserting and Removing Test Modules

To insert a module into the FTB-200 v2 Compact Modular Platform:

1. Turn off your unit.
2. Position the unit so that its front panel is facing you.

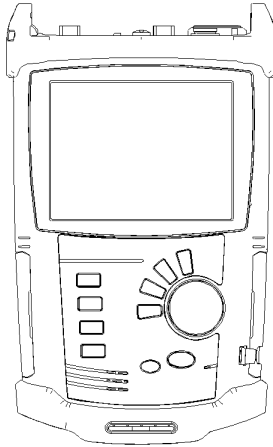

Getting Started with Your OTDR

Inserting and Removing Test Modules

3. Take the module and place it vertically so that the retaining screw hole is at the left of the connector pins.

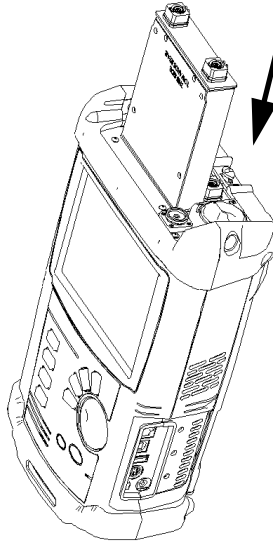

4. Insert the protruding edges of the module into the grooves of the unit's module slot.
5. Push the module all the way to the bottom of the slot, until the retaining screw makes contact with the unit casing.
6. Place the unit so that its bottom panel is facing you.

Getting Started with Your OTDR

Inserting and Removing Test Modules

7. While applying slight pressure to the module, lift the mobile part of the retaining screw and use it to turn the retaining screw clockwise until it is tightened.

This will secure the module into its “seated” position.

Turn retaining screws
clockwise

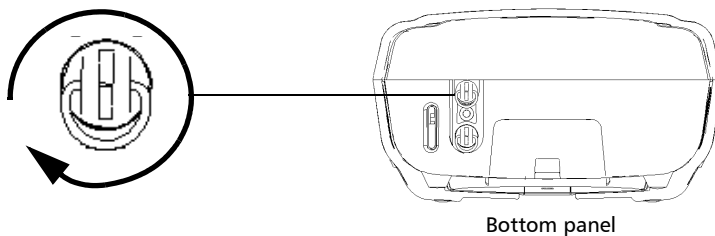

When you turn on the unit, the startup sequence will automatically detect the module.

To remove a module from the FTB-200 v2 Compact Modular Platform:

1. Turn off your unit.
2. Position the unit so that the bottom panel is facing you.
3. Lift the mobile part of the retaining screw and use it to turn the retaining screw counterclockwise until it stops.

The module will be slowly released from the slot.

Turn retaining screws
counterclockwise

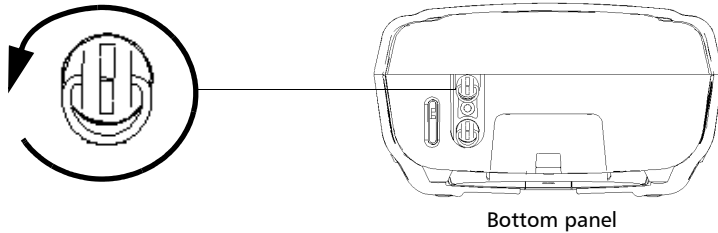

4. Place the FTB-200 v2 Compact Modular Platform so that the top panel is facing you.

Getting Started with Your OTDR

Inserting and Removing Test Modules

5. Hold the module by its sides or by the handle (*NOT by the connector*) and pull it out.

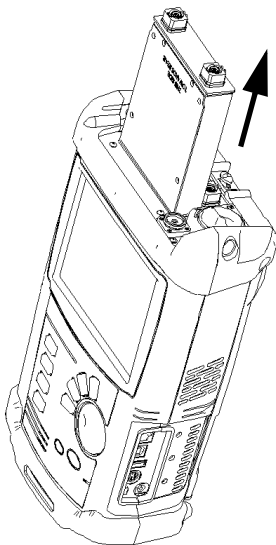

CAUTION

Pulling out a module by a connector could seriously damage both the module and connector. Always pull out a module by its casing.

6. Cover empty slots with the supplied protective covers.

Starting Module Applications

Your modules can be configured and controlled from their dedicated applications in Compact ToolBox.

To start a module application:

1. From Compact ToolBox, select the module to use.

It will turn blue to indicate that it is highlighted.

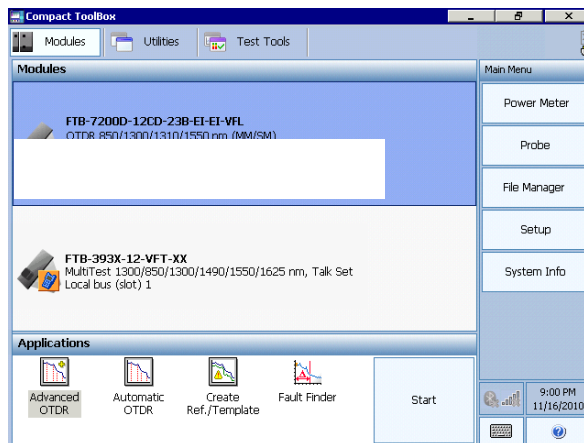

2. Under **Applications**, select an application, then press **Start**.

To start the Power Meter or Probe application:

From **Main Menu**, press **Power Meter** or **Probe**.

The main window (shown below) contains all the commands required to control the OTDR:

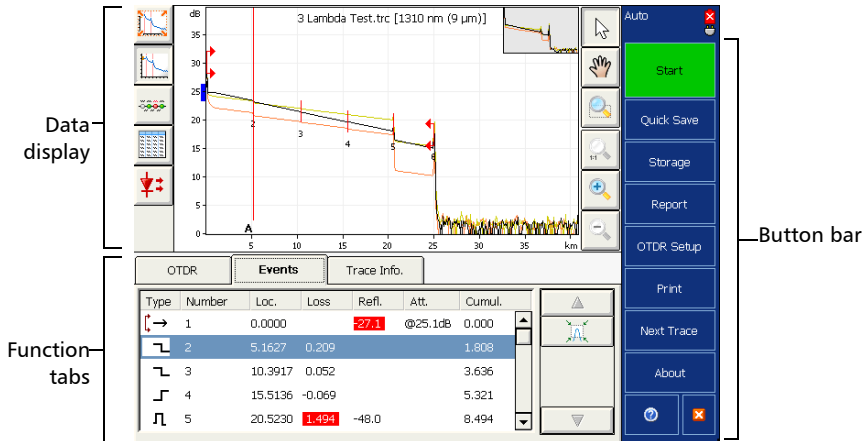

Timer

Once the acquisition has begun, a timer is displayed on the right-hand side of the screen, indicating the remaining time until the next acquisition.

4 **Preparing Your OTDR for a Test**

Installing the EXFO Universal Interface (EUI)

The EUI fixed baseplate is available for connectors with angled (APC) or non-angled (UPC) polishing. A green border around the baseplate indicates that it is for APC-type connectors.

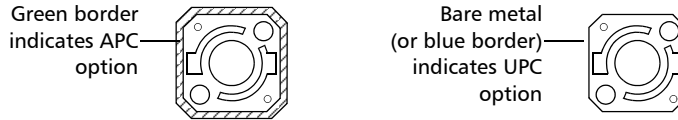

To install an EUI connector adapter onto the EUI baseplate:

1. Hold the EUI connector adapter so the dust cap opens downwards.

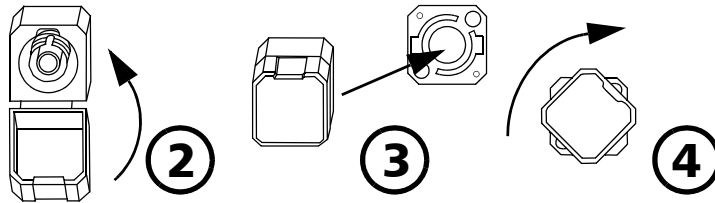

2. Close the dust cap in order to hold the connector adapter more firmly.
3. Insert the connector adapter into the baseplate.
4. While pushing firmly, turn the connector adapter clockwise on the baseplate to lock it in place.

Cleaning and Connecting Optical Fibers



IMPORTANT

To ensure maximum power and to avoid erroneous readings:

- Always inspect fiber ends and make sure that they are clean as explained below before inserting them into the port. EXFO is not responsible for damage or errors caused by bad fiber cleaning or handling.
- Ensure that your patchcord has appropriate connectors. Joining mismatched connectors will damage the ferrules.

To connect the fiber-optic cable to the port:

- 1.** Inspect the fiber using a fiber inspection microscope. If the fiber is clean, proceed to connecting it to the port. If the fiber is dirty, clean it as explained below.
- 2.** Clean the fiber ends as follows:
 - 2a.** Gently wipe the fiber end with a lint-free swab dipped in isopropyl alcohol.
 - 2b.** Use compressed air to dry completely.
 - 2c.** Visually inspect the fiber end to ensure its cleanliness.

- 3.** Carefully align the connector and port to prevent the fiber end from touching the outside of the port or rubbing against other surfaces.

If your connector features a key, ensure that it is fully fitted into the port's corresponding notch.

- 4.** Push the connector in so that the fiber-optic cable is firmly in place, thus ensuring adequate contact.

If your connector features a screwsleeve, tighten the connector enough to firmly maintain the fiber in place. Do not overtighten, as this will damage the fiber and the port.

Note: *If your fiber-optic cable is not properly aligned and/or connected, you will notice heavy loss and reflection.*

Preparing Your OTDR for a Test

Naming Trace Files Automatically

Naming Trace Files Automatically

Each time you start an acquisition, the application suggests a file name based on autonaming settings. This file name appears on the upper part of the graph and the linear view.

The file name is made of a static part (alphanumeric) and a variable part (numeric) that will be incremented or decremented, according to your selection, as follows:

If you choose incrementation...	If you choose decrementation...
Variable part increases until it reaches the <i>highest possible value</i> with the selected number of digits (for example, 99 for 2 digits), then restarts at 0.	Variable part decreases until it reaches 0, then restarts at the <i>highest possible value</i> with the selected number of digits (for example, 99 for 2 digits).

After saving a result, the unit prepares the next file name by incrementing (or decrementing) the suffix.

Note: *If you choose not to save a particular trace file, the suggested file name will remain available for the next trace you acquire.*

This function is particularly useful when working in Template mode or when testing multiple-fiber cables.

If you deactivate the automatic file naming function, the application will prompt you to specify a file name. The default file name is *Unnamed.trc*.

By default, traces are saved in native (.trc) format, but you can configure your unit to save them in Bellcore (.sor) format (see *Selecting the Default File Format* on page 93).

Note: If you select the Bellcore (.sor) format, the unit will create one file per wavelength (for example, TRACE001_1310.sor and TRACE001_1550.sor, if you included both 1310 nm and 1550 nm in your test). The native format contains all wavelengths in a single file.

To configure the automatic file naming:

1. From the button bar, press **OTDR Setup**.
2. Select the **Acquisition** tab.
3. Press **Default Trace Information**.

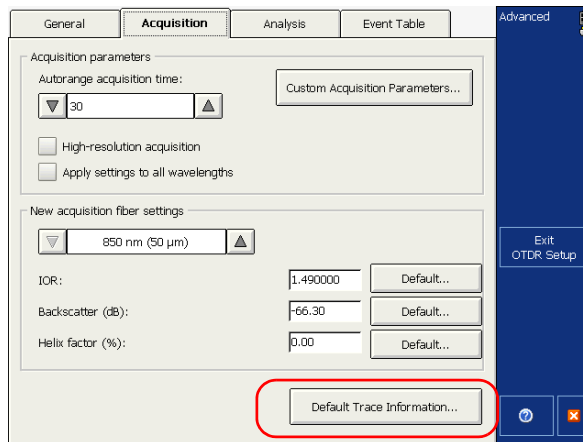

Preparing Your OTDR for a Test

Naming Trace Files Automatically

4. Fill out the required information in the corresponding boxes and select the direction for your trace files.

The 'Default Trace Information' dialog box is shown. It has a title bar 'Default Trace Information'. The 'Fiber' section includes: Fiber ID: Fiber001 (with a '...' button), Cable ID: Cable1, Location A: Quebec, Location B: Montreal, and Direction: A->B B->A. The 'Job' section includes: Job ID: (empty), Operator A: (empty), Operator B: (empty), Company: (empty), and Customer: (empty). There is a 'Comments' text area. At the bottom are buttons: Clear All, File Autonoming..., OK, and Cancel.

5. Press the  button appearing next to the **Fiber ID** box to change the contents of the fiber identification.
6. Change the criteria as needed, then press **OK** to confirm your new settings and return to the **Default Trace Information** window.

The 'Fiber Setup' dialog box is shown. It has a title bar 'Fiber Setup'. It contains: Prefix: fiber, Suffix: 002, Number of digits: 3 (dropdown menu), and Next value: Increment Decrement. At the bottom are buttons: OK and Cancel. Annotations: An arrow points from the text 'The variable part will increase or decrease depending on your choice' to the 'Increment/Decrement' radio buttons. Another arrow points from the text 'Value at which the autonumbering sequence starts Number of digits composing the variable part' to the 'Number of digits' dropdown menu.

7. Press **File Autonoming** to set up the trace file name options.

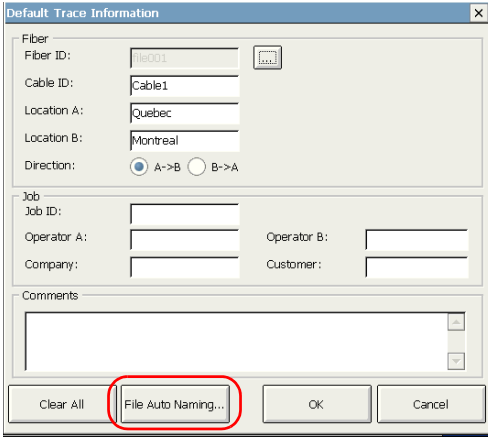

8. In the **File Name** window, select the desired components to include in the file name. You can change the order of apparition with the up and down arrow buttons.

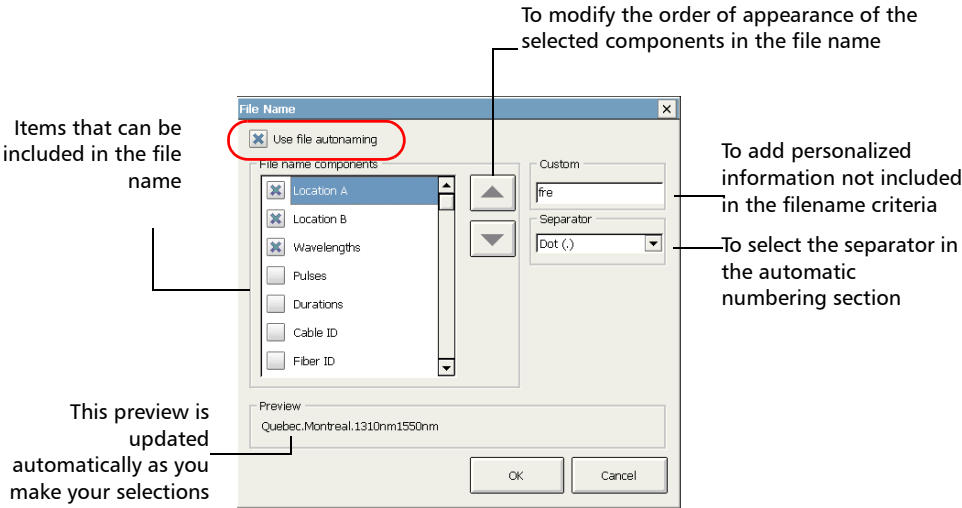

9. Press **OK** to confirm your new settings.

Preparing Your OTDR for a Test

Enabling or Disabling the First Connector Check

Enabling or Disabling the First Connector Check

Note: *This function is available in all OTDR modes. However, the first connector check parameter used in Fault Finder mode is independent from the one used in the other OTDR modes (Auto, Advanced and Template).*

The first connector check feature is used to verify that the fibers are properly connected to the OTDR. It verifies the injection level and displays a message when an unusually high loss occurs at the first connection, which could indicate that no fiber is connected to the OTDR port. By default, this feature is not enabled.

Note: *The first connector check is only performed when you test at singlemode wavelengths.*

To enable or disable the first connector check:

1. From the **Main Menu**, press **OTDR Setup** then press the **General** tab.
2. To enable the first connector check, select the **First connector check** box.

OR

To disable it, clear the box.

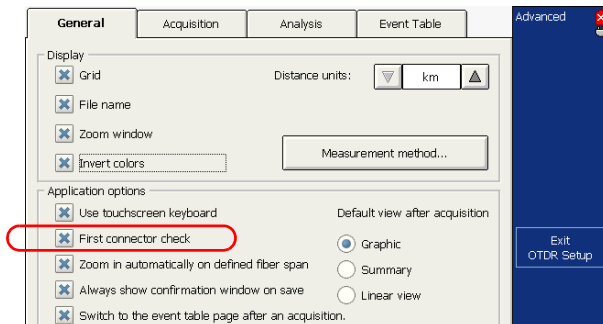

Setting Macrobend Parameters

Note: *This function is available both in Advanced and Auto modes.*

Your unit can locate macrobends by comparing the loss values measured at a certain location, for a certain wavelength (for example, 1310 nm) with the loss values measured at the corresponding location, but for a greater wavelength (for example, 1550 nm).

The unit will identify a macrobend when comparing two loss values if:

- Of the two loss values, the greater loss occurred at the greater wavelength.

AND

- The difference between the two loss values exceeds the defined delta loss value. The default delta loss value is 0.5 dB (which is suitable for most fibers), but you can modify it.

You can also disable macrobend detection.

Note: *Macrobend detection is only possible with singlemode wavelengths. Filtered wavelengths or wavelengths of dedicated OTDR ports are not available for macrobend detection.*

For information on how the information about macrobends is available after an acquisition, see *Linear View* on page 108 and *Summary Table* on page 110.

Preparing Your OTDR for a Test

Setting Macrobend Parameters

To set macrobend parameters:

1. From the **Main Menu**, press **OTDR Setup** then select the **General** tab.
2. To enable the macrobend detection, select the **Show macrobend** check box.

OR

To disable it, clear the check box.

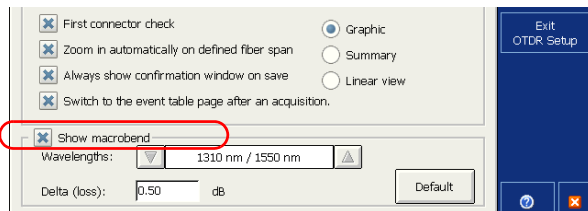

3. If necessary, set the delta value as follows:
 - 3a. From the **Wavelengths** list, select the pair of wavelengths for which you want to define the delta value.

Only the combinations of wavelengths your module can support will be available.

For more significant results, EXFO recommends to always select the combination of wavelengths including the smallest possible wavelength and the greatest wavelength (for example, if your module supports 1310 nm, 1550 nm, and 1625 nm, you would select the 1310 nm/1625 nm combination).
 - 3b. In the **Delta (loss)** box, enter the desired value.
 - 3c. Repeat steps 3a and 3b for all combinations of wavelengths.

To revert to default settings:

1. Press **Default**.
2. When the application prompts you, answer **Yes** if you want to apply the settings to all combinations of wavelengths.

Launch Conditions for Multimode Measurements

In a multimode fiber network, the attenuation of a signal is highly dependent on the mode distribution (or launch condition) of the source that emits this signal.

In the same way, the attenuation reading performed by any test instrument will also depend on the mode distribution of its light source.

A single light source cannot be conditioned for both 50 μm (50 MMF) and 62.5 μm (62.5 MMF) fibers at the same time:

- A source conditioned for 50 MMF testing will be under-filled for 62.5 MMF testing.
- A source conditioned for 62.5 MMF will be overfilled for 50 MMF testing.

TIA/EIA-455-34A (FOTP34, Method A2) is providing a target launch condition that is obtained when using an overfilled source followed by mandrel-wrap mode filter (five close-wound turns around a mandrel tool of a given diameter).

Your product has been conditioned for 62.5 MMF testing. However, you can also test with 50 MMF fibers.

Preparing Your OTDR for a Test

Launch Conditions for Multimode Measurements

The table below gives information about tests with the 50 μm and 62.5 μm fibers.

Fiber type	Recommended mode filter	Remarks
50 μm	<p>Perform a five-turn mandrel-wrap (wrapping the patchcord a minimum of five turns around the mandrel tool) on the patchcord connecting the OTDR to the fiber under test.</p> <p>As per FOTP-34:</p> <ul style="list-style-type: none">▶ For fibers with 3 mm jacket: use a mandrel tool with a diameter of 25 mm.▶ For fibers without jacket: use a mandrel tool with a diameter of 22 mm.	<p>Nominal launch conditions are overfilled.</p> <p>Loss measurements can be slightly pessimistic (higher loss) when compared to loss measurements done with a 50 MMF source compliant to FOTP34, Method A2.</p>
62.5 μm	No mode filter required.	Loss measurements similar to those obtained with a power meter and a source that is conditioned according to FOTP34, Method A2.



IMPORTANT

If you test with 50 μm fibers, EXFO recommends that you use a mode filter (mandrel-wrap). Otherwise, you may obtain results with a 0.1 to 0.3 dB excess loss.

5 *Testing Fibers in Auto Mode*

Auto mode automatically evaluates fiber length, sets acquisition parameters, acquires traces, and displays event tables and acquired traces.

In Auto mode, you can set the following parameters directly:

- Test wavelengths (all selected by default)
- Fiber type (singlemode, singlemode live, or multimode) for models supporting these fiber types
- Autorange acquisition time
- IOR (group index), RBS coefficient and helix factor

For all other parameters, the application uses those defined in Advanced mode, except that analysis is always performed after acquisitions.

If you ever need to modify other parameters, go to Advanced mode (see *Testing Fibers in Advanced Mode* on page 37 and *Preparing Your OTDR for a Test* on page 21).

In Auto mode, the application will automatically evaluate the best settings according to the fiber link currently connected to the unit (in less than 5 seconds). If you interrupt it, no data will be displayed.

Fiber characteristics are evaluated only once per session. Other fibers you connect to, within the same cable, will be tested with the same settings. When you start testing another link, you can reset these parameters.

Once this evaluation is complete, the application starts acquiring the trace. The trace display is continually updated.

Note: *You can interrupt the acquisition at any time. The application will display the information acquired to that point.*

Testing Fibers in Auto Mode

Once the acquisition is complete or interrupted, the analysis starts for acquisitions of 5 seconds or more.

After analysis, the trace is displayed and events appear in the events table.

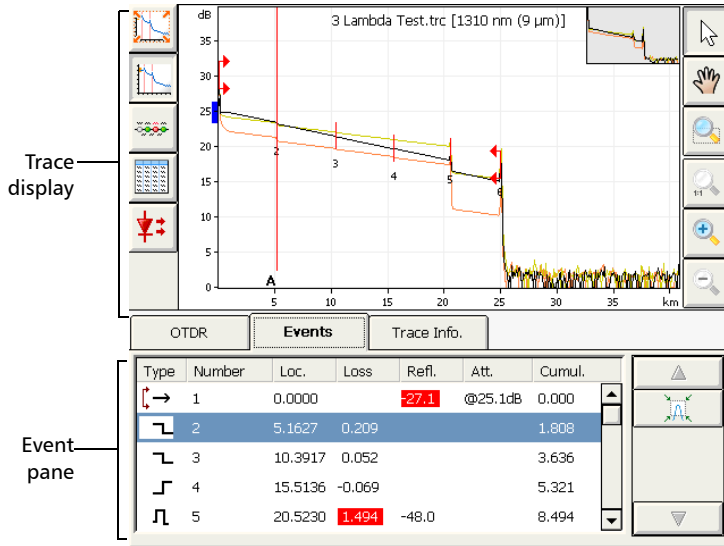

The application will also display status messages if you have selected to display pass/fail messages (see *Setting Pass/Fail Thresholds* on page 53).

You can save the trace after analysis. If former results have not been saved yet, the application prompts you to save them before starting a new acquisition.

To acquire traces in Auto mode:

1. Clean the connectors properly.
2. Connect a fiber to the OTDR port.

If your unit is equipped with two OTDR ports, ensure that you connect the fiber to the appropriate port (singlemode, singlemode live, or multimode), depending on the wavelength you intend to use.





CAUTION

Never connect a live fiber to the OTDR port without a proper setup. Any incoming optical power ranging from -65 dBm to -40 dBm will affect the OTDR acquisition. The way the acquisition will be affected depends on the selected pulse width. Any incoming signal greater than -20 dBm could damage your OTDR permanently. For live-fiber testing, refer to the SM Live port specifications for the characteristics of the built-in filter.

3. Set the autorange acquisition time (see *Setting the Autorange Acquisition Time* on page 42).
4. Go to the **OTDR** tab.
5. If your OTDR supports singlemode, singlemode live, or multimode wavelengths, under **Wavelengths**, from the list, select the desired fiber type (for live-fiber testing, select SM Live; for C fiber, select $50\ \mu\text{m}$ and for D fiber, select $62.5\ \mu\text{m}$).

OTDR	Events	Trace Info.
Wavelengths		
EM		
<input type="checkbox"/> 1310 nm		
<input type="checkbox"/> 1550 nm		
Settings		
Distance:	Pulse:	Acquisition time:
1,2500 km	1310 nm: 30ns 1550 nm: 30ns	30 s
<input type="button" value="Reset"/>		
Status		
Selected acquisition type: Singlemode (9 μm)		

Testing Fibers in Auto Mode

6. Select the boxes corresponding to the desired test wavelengths. You must select at least one wavelength.
7. If you want to clear the settings the OTDR has determined to start with a new set of OTDR settings, press **Reset**.
8. Press **Start** or  |  from the keypad.

If the first connector check feature is enabled, a message will appear if there is a problem with the injection level (see *Enabling or Disabling the First Connector Check* on page 28).

9. Once the analysis is complete, save the trace by pressing **Quick Save** in the button bar or  from the keypad.

The application will use a file name based on the autonaming parameters you defined (see *Naming Trace Files Automatically* on page 24). This file name appears at the top of the graph and at the top of the linear view table.

Note: *The application will only display the **Save File** dialog box if you have activated the feature to always be prompted when you save a file. From this dialog box, you can change the location, the file name and the file format.*

- 9a. If necessary, change the folder to which the file will be saved by pressing the **Location** button.
- 9b. If necessary, specify a file name.



IMPORTANT

If you specify the name of an existing trace, the original file will be overwritten and only the new file will be available.

10. Press **OK** to confirm.

6 *Testing Fibers in Advanced Mode*

Advanced mode offers all the tools you need to perform complete OTDR tests and measurements manually and gives you control over all test parameters.

Note: *Most parameters can only be set if you select Advanced mode first. Once you have finished selecting your settings, you can simply return to the test mode you prefer.*

By default, in Advanced mode, all available test wavelengths are selected.

In this mode, you can either set the acquisition parameters yourself or let the application determine the most appropriate values.

In the latter case, the application will automatically evaluate the best settings according to the fiber link currently connected to the unit:

- The pulse width will be determined using a factory-defined signal-to-noise ratio (SNR) requirement specified where the End-of-Fiber (EoF) event has been detected.

The EoF event detection algorithm uses the end-of-fiber threshold defined in the **tab** of the application setup. If you are not sure about which value to choose, revert to the factory default value for this parameter.

- The range will then be set automatically. This optimum value may differ from the values currently associated with the **Distance** dial of the main window. In this case, the application will “add” the required value and mark it with a * symbol.
- The application uses the acquisition time defined in the **Acquisition** tab of the OTDR setup (for more information, see *Setting the Autorange Acquisition Time* on page 42). The default value is 15 seconds. Longer acquisitions give better OTDR results.

Testing Fibers in Advanced Mode

Although the application sets the acquisition parameters, you can modify these values as needed, even while the acquisition is in progress. The OTDR simply restarts the averaging each time a modification is made.

Note: You can interrupt the acquisition at any time. The application will display the information acquired to that point.

Once the acquisition is complete or interrupted, the analysis starts for acquisitions of 5 seconds or more.

After analysis, the trace is displayed. Events appear both in the events table and in the linear view (if you purchased the optional software package).

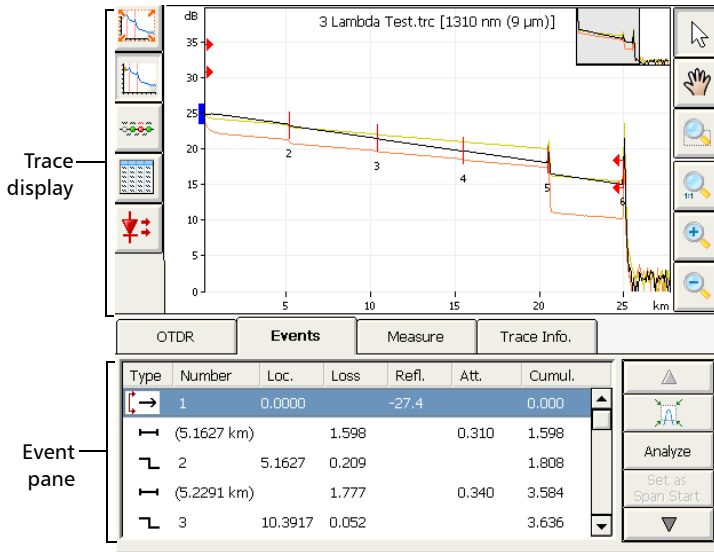

The application will also display pass/fail messages if you have selected this feature. For more information, see *Setting Pass/Fail Thresholds* on page 53.

You can save the trace after analysis. If former results have not been saved yet, the application prompts you to save them before starting a new acquisition.

To acquire traces:

1. Clean the connectors properly (see *Cleaning and Connecting Optical Fibers* on page 22).
2. Connect a fiber to the OTDR port.

If your unit is equipped with two OTDR ports, ensure that you connect the fiber to the appropriate port (singlemode, singlemode live, or multimode), depending on the wavelength you intend to use.



CAUTION

Never connect a live fiber to the OTDR port without a proper setup. Any incoming optical power ranging from -65 dBm to -40 dBm will affect the OTDR acquisition. The way the acquisition will be affected depends on the selected pulse width.

Any incoming signal greater than -20 dBm could damage your OTDR permanently. For live-fiber testing, refer to the SM Live port specifications for the characteristics of the built-in filter.

3. If you want the application to provide automatic acquisition values, set the autorange acquisition time (see *Setting the Autorange Acquisition Time* on page 42).
4. If you want to set your own IOR (group index), RBS coefficient or helix factor, see *Setting the IOR, RBS Coefficient, and Helix Factor* on page 43.
5. Go to the **OTDR** tab.
6. If you want to test in high resolution, simply select the feature (see *Enabling the High-Resolution Feature* on page 49).

Testing Fibers in Advanced Mode

7. If your OTDR supports singlemode, singlemode live, or multimode wavelengths, under **Wavelengths**, from the list, select the desired fiber type (for live-fiber testing, select SM Live; for C fiber, select 50 μm and for D fiber, select 62.5 μm).

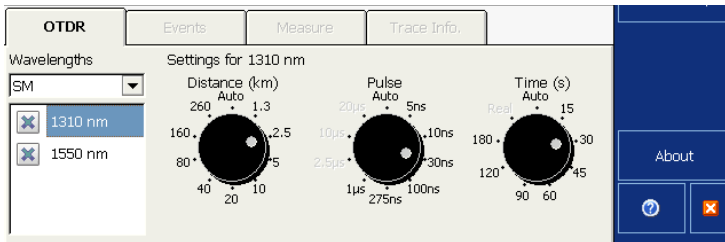

8. Select the boxes corresponding to the desired test wavelengths. You must select at least one wavelength.
9. Select the desired distance, pulse, and time values. For more information, see *Setting Distance Range, Pulse Width, and Acquisition Time* on page 45.
10. Press **Start** or  from the keypad. If the first connector check feature is enabled, a message will appear if there is a problem with the injection level (see *Enabling or Disabling the First Connector Check* on page 28).

You can modify the acquisition parameters as needed, while the acquisition is in progress. The OTDR simply restarts the averaging each time a modification is made.

11. Once the analysis is complete, save the trace by pressing **Quick Save** in the button bar or  from the keypad.

The application will use a file name based on the autonaming parameters you defined (see *Naming Trace Files Automatically* on page 24). This file name appears at the top of the graph and at the top of the linear view table.

Note: *The application will only display the **Save File** dialog box if you have activated the feature to always be prompted when you save a file. From this dialog box, you can change the location, the file name and the file format.*

11a. If necessary, change the folder to which the file will be saved by pressing the **Location** button.

11b. If necessary, specify a file name.



IMPORTANT

If you enter the name of an existing trace, the original file will be replaced with the new file.

12. Press **OK** to confirm.

Testing Fibers in Advanced Mode

Setting the Autorange Acquisition Time

Setting the Autorange Acquisition Time

Note: This function is available both in Advanced and Auto modes.

When performing automatic acquisitions in Advanced mode (see *Testing Fibers in Advanced Mode* on page 37) or before activating Auto mode (see *Testing Fibers in Auto Mode* on page 33), you can set an autorange acquisition time for the OTDR to average acquisitions over a set time period.

The application uses this value to determine the best settings for the test.

Note: In Template mode, the acquisition time of the reference trace is used for all trace acquisitions, not the autorange acquisition time.

To set the autorange acquisition time:

1. From the button bar, press **OTDR Setup** then go to the **Acquisition** tab.
2. Go to the **Autorange acquisition time** box and press the up or down arrow to select your preference. The default value is 30 seconds.
3. Press **Exit OTDR Setup** to return to the OTDR application.

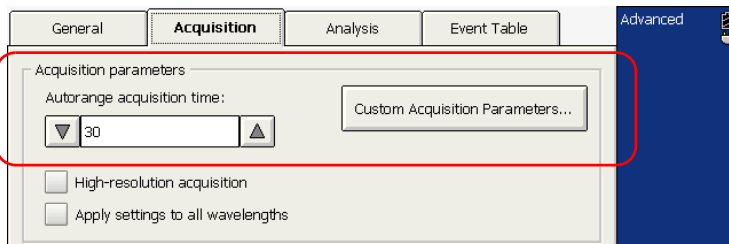

Setting the IOR, RBS Coefficient, and Helix Factor

Note: *This function is available both in Advanced and Auto modes.*

You should set the IOR (group index), RBS coefficient and helix factor before performing tests in order to apply them to all newly acquired traces. However, if you are in Advanced mode, you can also set them at a later time in the **Trace Info.** tab to reanalyze a specific trace.

- The index of refraction (IOR) value (also known as group index) is used to convert time-of-flight to distance. Having the proper IOR is crucial for all OTDR measurements associated with distance (event position, attenuation, section length, total length, etc.). IOR is provided by the cable or fiber manufacturer.

The test application determines a default value for each wavelength. You can set the IOR value for each available wavelength. You should verify this information before each test.

- The Rayleigh backscatter (RBS) coefficient represents the amount of backscatter in a particular fiber. The RBS coefficient is used in the calculation of event loss and reflectance, and it can usually be obtained from the cable manufacturer.

The test application determines a default value for each wavelength. You can set the RBS coefficient for each available wavelength.

- The helix factor takes into consideration the difference between the length of the cable and the length of the fiber inside the cable. Fibers within a cable are spiraling around the cable core. The helix factor describes the pitch of that spiral.

By setting the helix factor, the length of the OTDR distance axis is always equivalent to the physical length of the cable (not the fiber).

To set the IOR, RBS, and helix factor parameters:

- 1.** From the button bar, press **OTDR Setup**.

Testing Fibers in Advanced Mode

Setting the IOR, RBS Coefficient, and Helix Factor

- From the **OTDR Setup** window, go to the **Acquisition** tab.
- Use the up or down arrow located on the side of the wavelength box to select the desired wavelength.

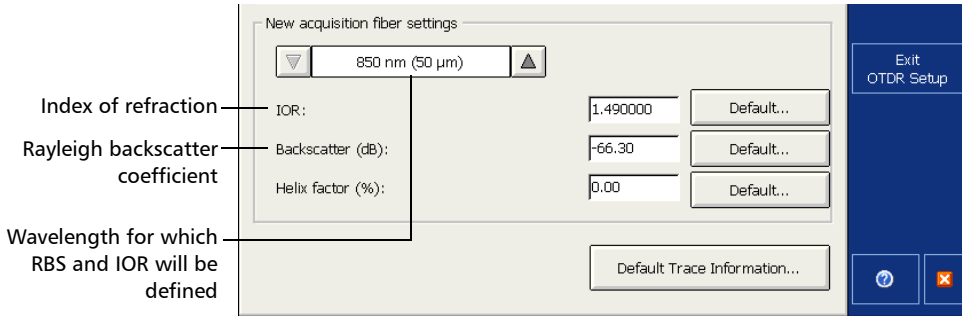

IMPORTANT

Change the default RBS coefficient *only* if you have values provided by the fiber manufacturer. If you set this parameter incorrectly, your reflectance measurements will be inaccurate.

- Select the default settings by pressing **Default**. When the application prompts you, answer **Yes** only if you want to apply the new settings to all wavelengths.

OR

Enter your own values in the boxes, for each available wavelength.

Note: *You cannot define a different helix factor for each wavelength. This value takes into account the difference between the length of the cable and the length of the fiber inside the cable; it does not vary with wavelengths.*

- Press **Exit OTDR Setup**.

Setting Distance Range, Pulse Width, and Acquisition Time

The distance range, pulse width and acquisition time are set with the controls in the Advanced main window.

- **Distance:** corresponds to the distance range of the fiber span to be tested according to the selected measurement units (see *Selecting the Distance Units* on page 96).

Changing the distance range alters the available settings of the pulse width and leaves only the settings available for the specified range. You can select either Auto or one of the predefined values.

If your OTDR model is FTB-7000D or later, you can customize the available distance range values (see *Customizing the Acquisition Distance Range Values* on page 98). If you select Auto, the application will evaluate the fiber length and set the acquisition parameters accordingly.

- **Pulse:** corresponds to the pulse width for the test. A longer pulse allows you to probe further along the fiber, but results in less resolution. A shorter pulse width provides higher resolution, but less distance range. The available distance ranges and pulse widths depend on your OTDR model.

Note: *Not all pulse widths are compatible with all distance ranges.*

You can select either Auto or one of the predefined values.

If you select Auto, the application will evaluate the fiber type and length and set the acquisition parameters accordingly.

Testing Fibers in Advanced Mode

Setting Distance Range, Pulse Width, and Acquisition Time

- ▶ **Time:** corresponds to the acquisition duration (period during which results will be averaged). Generally, longer acquisition times generate cleaner traces (this is especially true with long-distance traces) because as the acquisition time increases, more of the noise is averaged out. This averaging increases the signal-to-noise ratio (SNR) and the OTDR's ability to detect small events.

The time settings will also determine how the timer (displayed in the toolbar) counts time during testing (see *Timer* on page 20).

If the predefined values do not suit your needs, you can customize one or all of them. For more information, see *Customizing the Acquisition Time Values* on page 100.

In addition to the displayed values, the following time modes are available:

- ▶ **Real:** used to immediately view changes in the fiber under test. In this mode, the SNR of the trace is lower and the trace is refreshed instead of averaged until you press **Stop**.

You can alternate between real mode and averaging time interval mode while an acquisition is in progress.

Note: *The **Real** item will be available if only one wavelength is selected.*

- ▶ **Auto:** the application will use the autorange acquisition time that you have previously defined (see *Setting the Autorange Acquisition Time* on page 42). It will also evaluate the fiber type and length and set the acquisition parameters accordingly.

You can use the same distance range, pulse width and acquisition time parameters for testing at all wavelengths on a multiwavelength OTDR.



IMPORTANT

To test using the high-resolution feature, the acquisition time must be of at least 15 seconds.

Testing Fibers in Advanced Mode

Setting Distance Range, Pulse Width, and Acquisition Time

To set the parameters:

From the **OTDR** tab:

- Press the dial corresponding to the parameter you wish to set (the selection marker will move clockwise) or use the selection dial located on the front of the unit.

OR

- Press directly the value to select it. The selection marker will go to that value immediately.

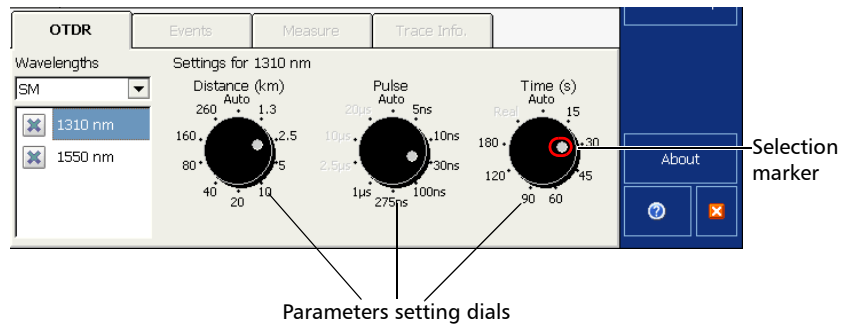

If you want the application to provide automatic acquisition values, move at least one dial to the **Auto** position. The other dials are automatically set accordingly.

Note: *If your OTDR supports singlemode, singlemode live, or multimode wavelengths, settings would be applied to either singlemode, singlemode live, or multimode wavelengths, depending on the selected fiber type (same settings for 50 µm and 62.5 µm).*

Testing Fibers in Advanced Mode

Setting Distance Range, Pulse Width, and Acquisition Time

To use the same pulse and acquisition time for all wavelengths:

1. From the button bar, press **OTDR Setup**, then go to the **Acquisition** tab.
2. Select the **Apply settings to all wavelengths** box.



The modifications you make to pulse, time, and range settings will now be applied to all wavelengths.

Enabling the High-Resolution Feature

If your OTDR model is FTB-7000D or later, You can select the high-resolution feature to obtain more data points per acquisition. This way, the data points will be closer to each other, which will result in a greater distance resolution for the trace.

Note: *When you test with the high-resolution feature, you should use a longer averaging time to maintain a signal-to-noise ratio (SNR) that will be equivalent to the one you would have got with the standard resolution.*

Note: *You can use high resolution with any test mode (except when you monitor fiber in real time), but you must be in Advanced mode to select it. In Template mode, you will have to acquire the reference trace using high resolution. This way, all subsequent acquisitions will use this feature automatically.*



IMPORTANT

To test using the high-resolution feature, the acquisition time must be of at least 15 seconds.

Testing Fibers in Advanced Mode

Enabling the High-Resolution Feature

To enable the high-resolution feature:

1. From the button bar, press **OTDR Setup**.
2. Go to the **Acquisition** tab.
3. Select the **High-resolution acquisition** box.

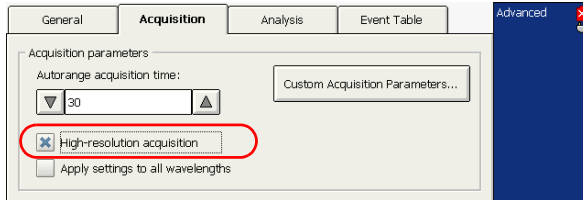

Note: *If your OTDR supports singlemode, singlemode live, or multimode wavelengths, the high-resolution feature will be activated either for the singlemode, singlemode live, or multimode wavelengths, depending on the selected fiber type.*

4. Press **Exit OTDR Setup** to return to the main window.

Enabling or Disabling Analysis After Acquisition

The OTDR trace acquisition procedure will be completed by the analysis. You can either choose to automatically analyze each trace immediately after the acquisition, or perform the analysis whenever it suits you best.

When the analysis process is disabled, the Event table of a newly acquired trace will be empty.

You can also set a default fiber span, which will be applied during the analysis of all traces to display test results. For details, see *Setting a Default Span Start and Span End* on page 58.

Note: *In Auto mode, the application always performs an analysis after the acquisition.*

Testing Fibers in Advanced Mode

Enabling or Disabling Analysis After Acquisition

To enable or disable the analysis after trace acquisition:

1. From the button bar, press **OTDR Setup**.
2. Go to the **Analysis** tab.
3. If you want the OTDR to automatically analyze an acquired trace, select the **Automatically analyze data after acquisition** box.

If you clear the check box, the trace will be acquired without being analyzed.

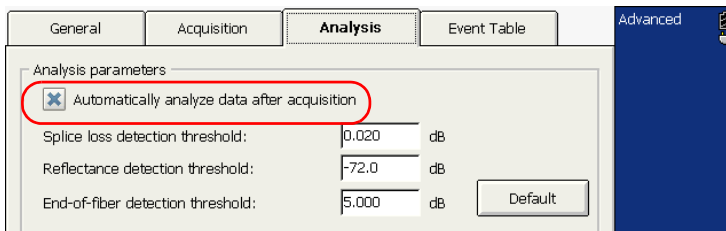

Note: *By default, traces are automatically analyzed as they are acquired.*

4. Press **Exit OTDR Setup** to return to the main window.

Setting Pass/Fail Thresholds

You can activate and set Pass/Fail threshold parameters for your tests.

You can set thresholds for splice loss, connector loss, reflectance, fiber section attenuation, span loss, span length, and span ORL. You can apply the same pass/fail thresholds to all test wavelengths or apply them separately to each one.

You can set different pass/fail thresholds for each available test wavelength. These pass/fail thresholds will be applied to the analysis results of all newly acquired traces with the corresponding wavelength.

By default, the application provides threshold values for the following wavelengths: 1310 nm, 1383 nm, 1390 nm, 1410 nm, 1490 nm, 1550 nm, 1625 nm, and 1650 nm. However, if you work with files containing other wavelengths, the application will automatically add these custom wavelengths to the list of available wavelengths. You will then be able to define thresholds for these new wavelengths. You can revert all thresholds to their default values, except if they are associated with custom wavelengths.

The loss, reflectance and attenuation thresholds that you set are applied to all events where such values can be measured. Setting these thresholds allows you either to ignore events with known lower values, or to ensure that all events are detected—even the ones for which very small values are measured.

Testing Fibers in Advanced Mode

Setting Pass/Fail Thresholds

The following table provides the default, minimum and maximum thresholds.

Test	Default	Minimum	Maximum
Splice loss (dB)	1.000	0.015	5.000
Connector loss (dB)	1.000	0.015	5.000
Reflectance (dB)	-40.00	-80.0	0.0
Fiber section attenuation (dB/km)	0.400	0.000	5.000
Span loss (dB)	45.000	0.000	45.000
Span length (km)	0.00	0.0000	300.0000
Span ORL (dB)	15.00	15.00	40.00

Once the thresholds are set, the application will be able to perform Pass/Fail tests to determine the status of the various events (pass or fail).

The Pass/Fail test is performed on two occasions:

- when analyzing or reanalyzing a trace
- when you open a trace file

Values that are greater than the predefined thresholds are displayed in white on a red background in the events table.

The Pass/Fail threshold LED, located on the front of the unit, will also indicate the status (green for pass, red for fail).

You can also set the application to display pass/fail messages when the Pass/Fail test is performed.

To set pass/fail thresholds:

1. From the button bar, select **OTDR Setup**, then select the **Event Table** tab.
2. From the **Wavelength** list, select the wavelength for which you want to set thresholds.

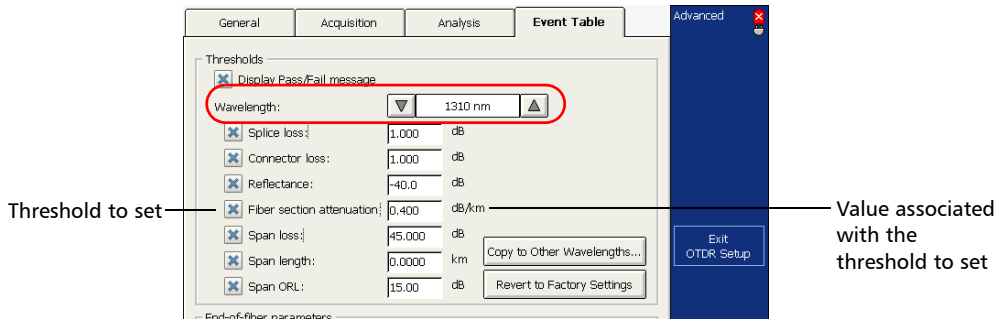

3. Select the boxes corresponding to the thresholds that you want to use, and enter the desired values in the appropriate fields.

Note: If you no longer want the application to take into account a particular threshold, simply clear the corresponding box.

4. If you want the application to display messages when events fail the test, select **Display Pass/Fail message**.

Testing Fibers in Advanced Mode

Setting Pass/Fail Thresholds

5. If you want to apply the thresholds you have just defined to one or several other wavelengths, proceed as follows:
 - 5a. Press the **Copy to Other Wavelengths** button.
 - 5b. Select the boxes corresponding to the wavelengths for which you want to use the same thresholds.

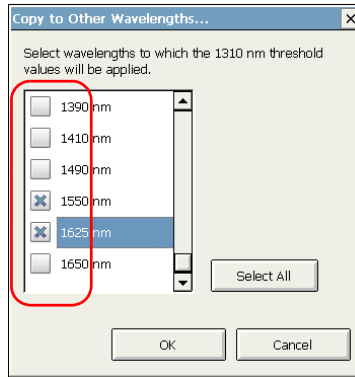

Note: You can use the **Select All** button to quickly select all boxes at the same time.

- 5c. Press **OK** to confirm your selection.
6. Press **Exit OTDR Setup** to return to the main window.

To revert to default threshold values and to delete custom wavelengths:

- 1.** From the button bar, select **OTDR Setup**, then select the **Event Table** tab.
- 2.** Press the **Revert to Factory Settings** button.
- 3.** When the application prompts you, confirm the modification with **Yes**.

All threshold values of all wavelengths are returned to their default values, except for thresholds that are associated with custom wavelengths.



IMPORTANT

When you revert thresholds to their default values, custom wavelengths will be deleted from the list of available wavelengths, except if a file using at least one of these wavelengths is still open.

Setting a Default Span Start and Span End

By default, the span start and span end of a fiber are assigned, respectively, to the first event (the launch level event) and the last event (often a non-reflective or reflective end event) of a trace.

You can change the default fiber span that will be applied during the initial trace analysis.

You can set the span start and span end on a particular event or at a certain distance value from the beginning or end of the trace. You can even define a fiber span for short fibers by placing the span start and the span end on the same event.

- By default, the number of available events is set to 10 and, therefore, does not necessarily reflect the actual number of events displayed.
- When you set a distance value for the span start or end, the application searches for a nearby event. If it finds one, the span start or end is assigned to that event, rather than at the exact distance you have set.

Changes to the span start and span end will modify the contents of the events table. The span start becomes event 1 and its distance reference becomes 0. Events excluded from the fiber span are grayed out in the events table, and do not appear in the trace display. The cumulative loss is calculated within the defined fiber span only.

Note: *You can also change the fiber span of a single trace after the analysis and reanalyze the trace (see Analyzing or Reanalyzing a Trace on page 151). However, if you want to keep working with the original parameters, you must reenter them.*

To change the default span start and span end for traces:

1. From the button bar, press **OTDR Setup**.
2. From the **OTDR Setup** window, go to the **Analysis** tab.
3. If you want to set the span start and end with a distance value, under **Span start** and **Span end**, select **Set by distance**. Go to the **Position** box and enter the desired value, using the distance units displayed to the right of the field.

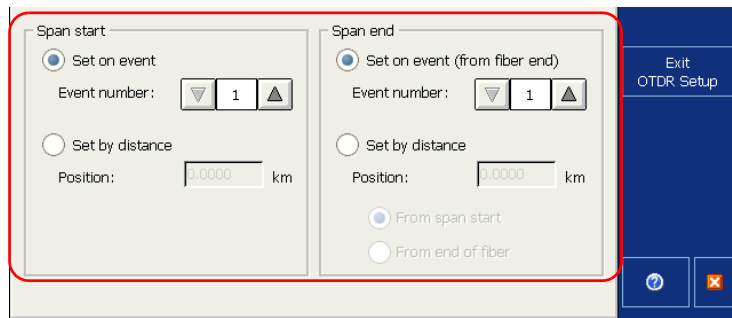

Under **Span end**, indicate whether the span end position is from the fiber span start or from the end of the fiber.

OR

If you want to set the span start and end on a particular event, under **Span start** and **Span end**, select **Set on event**.

From the **Event number** field, use the up or down arrow to select the number of the event that you want to designate as span start or span end.

The span event parameters are applied to all newly acquired traces.

7 **Testing Fibers in Template Mode**

Template mode allows you to test fibers and compare them to a reference trace that was previously acquired and analyzed.

Template Principle

Cables contain numerous fibers. Theoretically, on all these fibers, you will find the same events at the same location (due to connectors, splices, etc.). Template mode allows you to test these fibers one after the other quickly and efficiently and ensures that no event remains undetected.

The Template mode concept is to acquire a reference trace (template), add information and comments on the current job, then save the trace.

For a more accurate reference trace, you can update it with new events that may occur during the first acquisitions (up to fifteen).

The test application will flag possible problems and discrepancies between the reference trace and other traces.

Each new acquisition will be compared to the reference trace and the software will mark and measure any missing event.

If the reference trace was created with the ToolBox software on an FTB-500 or a computer, the event-related comments inserted in the reference trace, as well as the reference trace report, are automatically copied to subsequent traces.

Note: *You cannot add comments to events or to a reference trace.*

Testing Fibers in Template Mode

Restrictions of Template Mode

You can save the trace after analysis. If former results have not been saved yet, the application prompts you to save them before starting a new acquisition.

Template mode can be used on an unlimited number of traces, as long as you have at least one reference trace. Thus, you can use Template mode to automate trace acquisition.

Restrictions of Template Mode

To speed up trace acquisition in Template mode, certain restrictions apply.

- The parameters used to acquire the reference trace are automatically applied when acquiring subsequent traces (including the high-resolution feature, when applicable).
- The reference trace and subsequent traces must be acquired using identical wavelength(s), but pulse settings can be adjacent and still be accepted.
- The OTDR that you intend to use must support at least one wavelength that was used to acquire the reference trace.
- The reference trace and subsequent traces (or recalled traces) must respect the following criteria:

Item	To be valid...
Pulse width	<p>► Must be:</p> $\left(\frac{\text{Reference trace pulse}}{4} \right) \leq \text{Current trace pulse}$ <p>OR</p> $\text{Current trace pulse} \leq (\text{Reference trace pulse} \times 4)$
Pulse width	<p>► This would also be valid:</p> $\left(\frac{\text{Current trace pulse}}{4} \right) \leq \text{Reference trace pulse}$ <p>OR</p> $\text{Reference trace pulse} \leq (\text{Current trace pulse} \times 4)$
Fiber types	<p>Compare singlemode traces with singlemode traces. Compare multimode traces with multimode traces.</p>
Number of events	<p>Traces must have at least two events (span start and span end) and a fiber section.</p>
Acquisition mode	<p>Reference trace must not be acquired in Real mode (see <i>Setting Distance Range, Pulse Width, and Acquisition Time</i> on page 45).</p>
Wavelengths	<p>Reference wavelengths and wavelengths of subsequent (or reloaded) traces must be identical.</p>

When you process traces using an OTDR, you acquire the traces as you go along. When you process traces on a computer, you use traces stored on disk; therefore, applying the span length is optional.

Acquiring the Reference Trace

You must acquire a reference trace *before* you start the Template mode. The acquisition parameters you define for this reference trace will be used to acquire subsequent traces.

To acquire the reference trace:

1. Clean the connectors properly (see *Cleaning and Connecting Optical Fibers* on page 22).
2. Connect a fiber to the OTDR port.

If your unit is equipped with two OTDR ports, ensure that you connect the fiber to the appropriate port (singlemode, singlemode live, or multimode), depending on the wavelength you intend to use.



CAUTION

Never connect a live fiber to the OTDR port without a proper setup. Any incoming optical power ranging from -65 dBm to -40 dBm will affect the OTDR acquisition. The way the acquisition will be affected depends on the selected pulse width. Any incoming signal greater than -20 dBm could damage your OTDR permanently. For live-fiber testing, refer to the SM Live port specifications for the characteristics of the built-in filter.

3. Acquire a trace in Auto or Advanced test mode. If you want to test using high resolution, you will have to select this feature *before* acquiring the reference trace. For more information, see *Testing Fibers in Auto Mode* on page 33 or *Testing Fibers in Advanced Mode* on page 37.
4. If necessary, define the span start and end (see *Analyzing the Fiber on a Specific Fiber Span* on page 153).
5. Once the analysis is complete, save the trace by pressing **Quick Save** in the button bar or  from the keypad.

The application will use a file name based on the autonaming parameters you defined (see *Naming Trace Files Automatically* on page 24). This file name appears at the top of the graph and at the top of the linear view table.

Note: *The application will only display the **Save File** dialog box if you have activated the feature to always be prompted when you save a file. From this dialog box, you can change the location, the file name and the file format.*

Acquiring Traces in Template Mode

To acquire traces in Template mode, you must first open your reference trace in the application.

If you want your reference trace to be more accurate, you can update it with the new events that might be found.

The application will automatically switch to Template mode once the reference update is complete, that is, after 15 acquisitions or after you stop the update manually.

To acquire traces in Template mode:

1. If necessary, clean the connectors (see *Cleaning and Connecting Optical Fibers* on page 22) and connect a fiber to the OTDR port.

If your unit is equipped with two OTDR ports, ensure that you connect the fiber to the appropriate port (singlemode, singlemode live, or multimode), depending on the wavelength you intend to use.



CAUTION

Never connect a live fiber to the OTDR port without a proper setup. Any incoming optical power ranging from -65 dBm to -40 dBm will affect the OTDR acquisition. The way the acquisition will be affected depends on the selected pulse width. Any incoming signal greater than -20 dBm could damage your OTDR permanently. For live-fiber testing, refer to the SM Live port specifications for the characteristics of the built-in filter.

2. When the application prompts you, select the trace you want to use as the reference trace. If you do not select it immediately, you will have to select it manually before starting your test (see *Selecting a Reference Trace* on page 74). By default, all wavelengths are selected, but you can adjust the selection to your needs.

3. Set test parameters.

3a. From the button bar, press **OTDR Setup**.

3b. Select the **Create Ref./Template** tab.

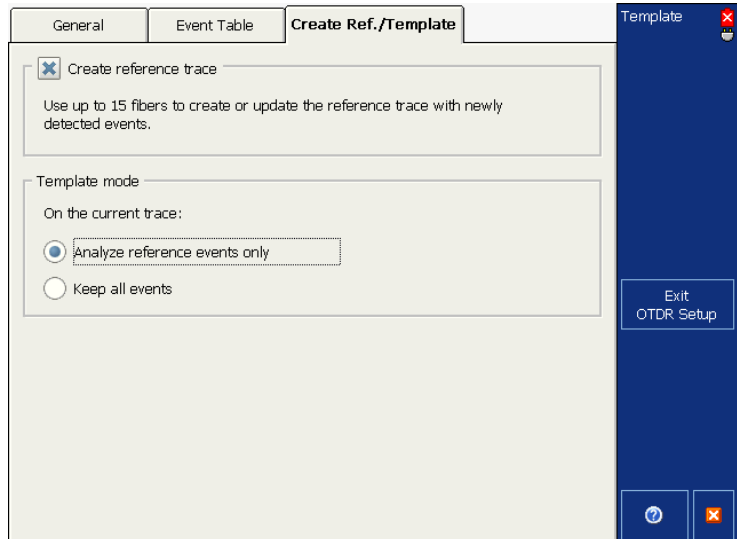

If necessary, select **Create reference trace** to update your reference trace for the next acquisitions.

This mode will use the first 15 traces (or less, if you stop the process manually) to continue compiling events.

Note: *You can disable the mode by clearing the **Create reference trace** box between two acquisitions.*



Testing Fibers in Template Mode

Acquiring Traces in Template Mode



IMPORTANT

Once the first 15 acquisitions have been performed, or if you stop the reference update manually, the only way to reactivate it will be to close the application and start a new acquisition in Template mode.

- 3c.** Set the Template mode option you want to use on the current trace acquisition:
 - Consider only the events already indicated on the reference trace and ignore any other event occurring on the current trace.
 - Keep all the events on the current trace, whether they are on the reference trace or not. You can delete these events later.
- 3d.** Press **Exit OTDR Setup** to return to the main window.
- 3e.** If you selected **Create reference trace** at step 4b, update your reference trace as follows:
- 3f.** Press **Start** or  |  from the keypad.

If the first connector check feature is enabled, a message will appear if there is a problem with the injection level (see *Enabling or Disabling the First Connector Check* on page 28).

All traces will automatically be acquired and analyzed, and the events will be identified.

4. If applicable, the application will display the number of new events detected for each wavelength.

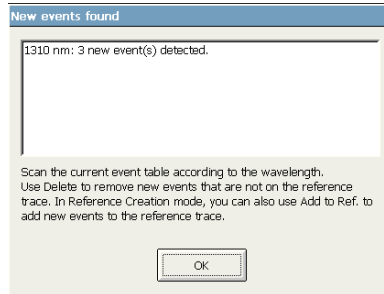

- 4a. Press **OK** to close the dialog box.

Note: *You can only add events to the reference trace during reference update.*

Note: *If you chose the **Keep all events** feature for the acquisitions that will be performed after the update, you may find it useful to add newly detected events to obtain a more accurate reference trace.*

Testing Fibers in Template Mode

Acquiring Traces in Template Mode

- Question marks will appear in the **Event** table to identify new events not found on the reference trace. If you want to add these marked events to the reference trace, press **Add to Ref.** You can also delete unwanted events with the **Delete** button.

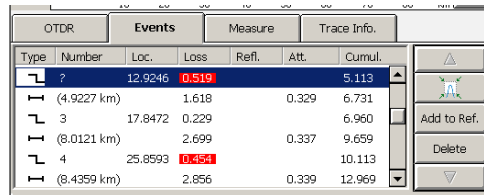

Type	Number	Loc.	Loss	Refl.	Att.	Cumul.
?		12.9246	0.519			5.113
*		(4.9227 km)	1.618		0.329	6.731
?	3	17.8472	0.229			6.960
*		(8.0121 km)	2.699		0.337	9.659
?	4	25.8593	0.655			10.113
*		(8.4359 km)	2.856		0.339	12.969

- Asterisks (“*”) identify events that were not found on the main trace, but that were added because they exist on the reference trace.
- Question marks identify events found on the main trace that do not exist on the reference trace. Numbers will be assigned to new events when the trace is analyzed.

Asterisks and question marks are used to identify events without modifying the existing event numbers. This way, you can match the events of the reference trace with those of the main trace more easily.

Note: If you select the **Analyze Reference Events Only** feature (from OTDR setup), the **Add to Ref.** and **Delete** buttons are unavailable. Events that are not on the reference trace, but that are detected on the acquired trace, are deleted.

- 5a.** Once the analysis is complete, save the trace by pressing **Quick Save** in the button bar or  from the keypad.

The application will use a file name based on the autonaming parameters you defined (see *Naming Trace Files Automatically* on page 24). This file name appears at the top of the graph and at the top of the linear view table.

Note: *The application will only display the **Save File** dialog box if you have activated the feature to always be prompted when you save a file. From this dialog box, you can change the location, the file name and the file format.*

- 5b.** Repeat steps 3f to 5a as necessary to update your reference trace.

Testing Fibers in Template Mode

Acquiring Traces in Template Mode

6. Once the reference update is complete (or if you did not select the reference update), the application automatically switches to Template mode. New events will be managed according to the option you selected at step 3c. Perform acquisitions in Template mode as follows:

- 6a.** Press **Start** or  from the keypad.

If the first connector check feature is enabled, a message will appear if there is a problem with the injection level (see *Enabling or Disabling the First Connector Check* on page 28).

All traces will automatically be acquired and analyzed, and the events will be identified.

- 6b.** The application will prompt you if new events are found.

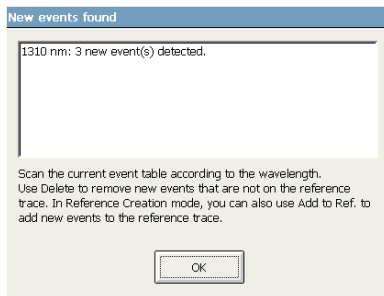

- 6c.** Once the analysis is complete, save the trace by pressing **Quick Save** in the button bar or  from the keypad.

The application will use a file name based on the autonaming parameters you defined (see *Naming Trace Files Automatically* on page 24). This file name appears at the top of the graph and at the top of the linear view table.

Note: *The application will only display the **Save File** dialog box if you have activated the feature to always be prompted when you save a file. From this dialog box, you can change the location, the file name and the file format.*

- 6d.** Repeat steps 3c to 6c as necessary.

Testing Fibers in Template Mode

Selecting a Reference Trace

Selecting a Reference Trace

In **Template OTDR** mode, you can only select a file as a reference trace. This operation is closely related to opening a trace file. All the traces, will be displayed using the zoom and markers settings saved along with the reference trace file (see *Opening Trace Files* on page 159).

Note: *The following procedure will be useful if you did not select a reference trace file when the **Open Reference Trace File** dialog box appeared during the activation of Template OTDR mode or if you want to use another reference trace.*

To select a reference trace:

1. From the **Main Menu** window, press **Storage**, then **Open Reference**.

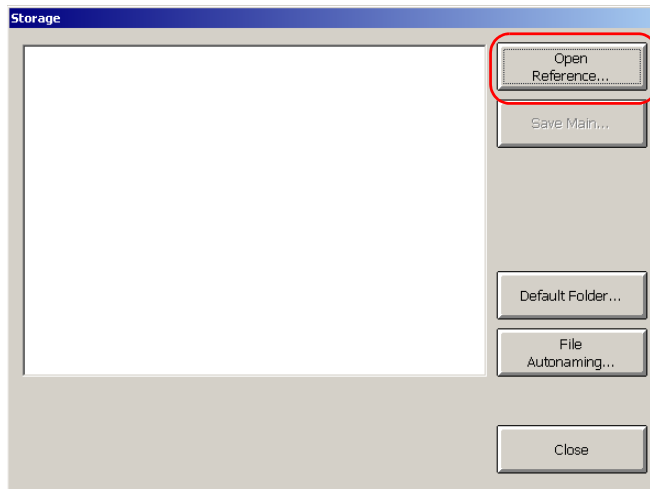

2. If necessary, select the storage location from where you want to open the file.
3. Select the file to be used as a reference and press **OK**.

The application opens the selected trace file automatically.

8 **Testing Fibers in Fault Finder Mode**

The application offers you a special testing feature to rapidly locate fiber ends. It also displays the length of the fiber under test.

This could be useful if you want to perform a quick test without having to set all the acquisition parameters.

Acquiring Traces in Fault Finder Mode

The unit will determine the more appropriate wavelength (singlemode or multimode, depending on your test configuration). It will use the default IOR (group index), RBS coefficient, and helix factor. The duration of acquisition is 45 seconds.

To acquire traces in Fault finder mode:

1. Clean the connectors properly (see *Cleaning and Connecting Optical Fibers* on page 22).
2. Connect a fiber to the OTDR port.

If your unit is equipped with two OTDR ports, ensure that you connect the fiber to the appropriate port (singlemode, singlemode live, or multimode), depending on the wavelength you intend to use.



CAUTION

Never connect a live fiber to the OTDR port without a proper setup. Any incoming optical power ranging from -65 dBm to -40 dBm will affect the OTDR acquisition. The way the acquisition will be affected depends on the selected pulse width.



Any incoming signal greater than -20 dBm could damage your OTDR permanently. For live-fiber testing, refer to the SM Live port specifications for the characteristics of the built-in filter.

Testing Fibers in Fault Finder Mode

Acquiring Traces in Fault Finder Mode

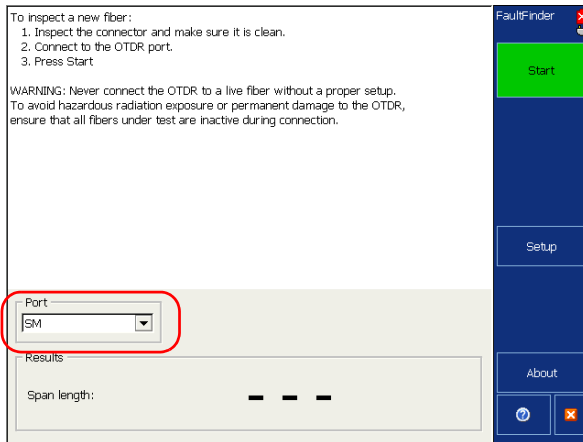
3. From the **Port** list, specify to which port you connected your fiber (for C fiber, select 50 μm and for D fiber, select 62.5 μm).



4. Press **Start** or  |  from the keypad. If the first connector check feature is enabled, a message will appear if there is a problem with the injection level (see *Enabling or Disabling the First Connector Check for Fault Finder* on page 85).

5. Once the analysis is complete, save the trace by pressing **Quick Save** in the button bar or  from the keypad.

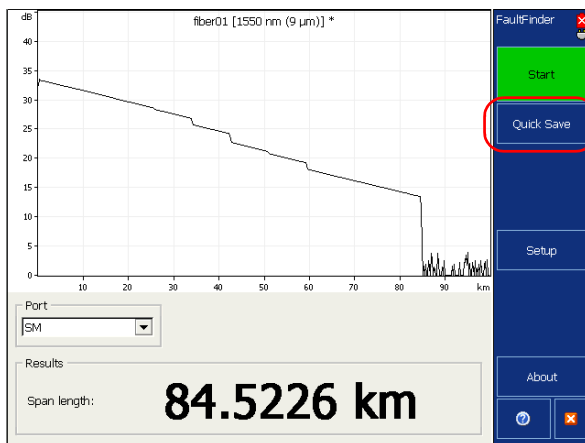

The application will use a file name based on the autonaming parameters you defined (see *Naming Fault Finder Files Automatically* on page 78). This file name appears at the top of the graph.

Note: *The application will only display the **Save File** dialog box if you have activated the feature to always be prompted when you save a file and if you did not disable the storage features. From the **Save File** dialog box, you can change the location, the file name and the file format.*

- 5a. If necessary, change the folder to which the file will be saved by pressing the **Location** button.
- 5b. If necessary, specify a file name.



IMPORTANT

If you specify the name of an existing trace, the original file will be overwritten and only the new file will be available.

- 5c. Press **OK** to confirm.

Testing Fibers in Fault Finder Mode

Naming Fault Finder Files Automatically

Naming Fault Finder Files Automatically

Each time you start an acquisition, the Fault Finder application suggests a file name based on autonaming settings. This file name appears on the upper part of the graph.

Note: *The autonaming settings used in Fault Finder mode are independent from those used in Auto, Advanced or Template modes. File names are built following the same principle, but there is one set of settings for Fault Finder and one set of settings for the other OTDR modes.*

The file name is made of a static part (alphanumeric) and a variable part (numeric) that will be incremented or decremented, according to your selection, as follows:

If you choose incrementation...	If you choose decrementation...
Variable part increases until it reaches the <i>highest possible value</i> with the selected number of digits (for example, 99 for 2 digits), then restarts at 0.	Variable part decreases until it reaches 0, then restarts at the <i>highest possible value</i> with the selected number of digits (for example, 99 for 2 digits).

After saving a result, the unit prepares the next file name by incrementing (or decrementing) the suffix.

Note: *If you choose not to save a particular trace file, the suggested file name will remain available for the next trace you will acquire.*

By default, traces are saved in native (.trc) format, but you can configure your unit to save them in Bellcore (.sor) format (see *Selecting the Default File Format for the Fault Finder Traces* on page 80).

To configure the automatic file naming:

1. From the button bar, press **Setup**.
2. From the **Setup** window, select the **General** tab then press the **File Autonaming** button.

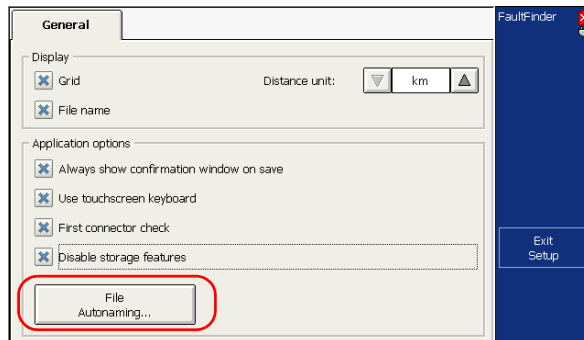

3. From the **Autonaming Setup** dialog box, set the parameters.

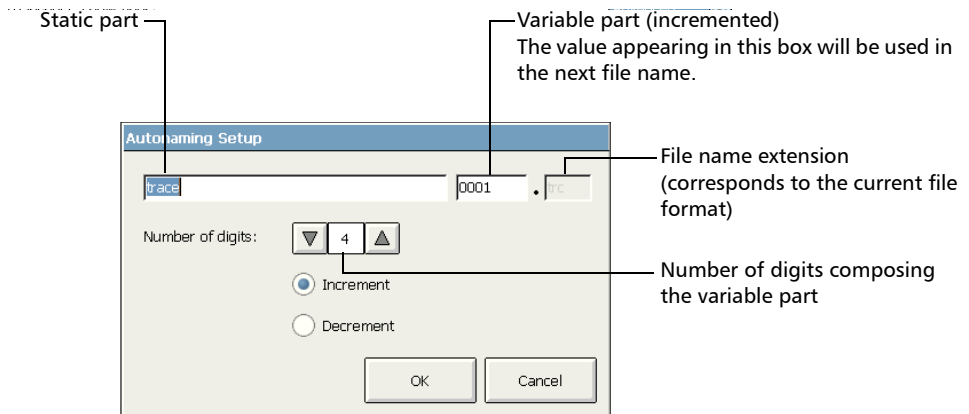

If you want the variable part to increase each time a file is saved, select **Increment**. If you want it to decrease, select **Decrement**.

4. Press **OK** to confirm your new settings.

Selecting the Default File Format for the Fault Finder Traces

You can define the default file format the Fault Finder application will use when you save your traces.

Note: *The default file format used in Fault Finder mode are independent from the file format used in Auto, Advanced or Template modes. There is one default file format for Fault Finder and one default file format for the other OTDR modes.*

By default, traces are saved in native (.trc) format, but you can configure your unit to save them in Bellcore (.sor) format.

You can only modify the file format from the **Save File** dialog box, which means you need to save at least one trace in the desired format before it becomes the new default file format.

Note: *The application will only display this dialog box if you have activated the feature to always be prompted when you save a file (see Enabling or Disabling the Confirmation of Fault Finder File Name on page 82) and if you did not disable the storage features.*

To select the default file format:

1. From the button bar, press **Quick Save**.
2. From the **Save File** dialog box, select the desired format.

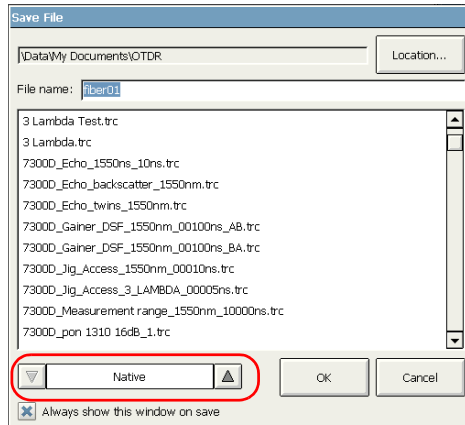

3. Press **OK** to save your file in the new format. The next files will be saved in the new format.

Testing Fibers in Fault Finder Mode

Enabling or Disabling the Confirmation of Fault Finder File Name

Enabling or Disabling the Confirmation of Fault Finder File Name

By default, each time you save a file, the application prompts you to confirm the file name.

Note: *The file name confirmation parameter used in Fault Finder mode is independent from the one used in the other OTDR modes (Auto, Advanced and Template).*

The application will use a file name based on autonaming settings (see *Naming Fault Finder Files Automatically* on page 78).

If you prefer to hide the **Quick Save** button, see *Enabling or Disabling the Storage Feature* on page 84.

Testing Fibers in Fault Finder Mode

Enabling or Disabling the Confirmation of Fault Finder File Name

To enable or disable file name confirmation:

1. From the button bar, press **Setup**, then go to the **General** tab.
2. If you want to confirm file name each time you press **Quick Save**, select the **Always show confirmation window on save** check box.

OR

If you never want to be prompted, clear the check box.

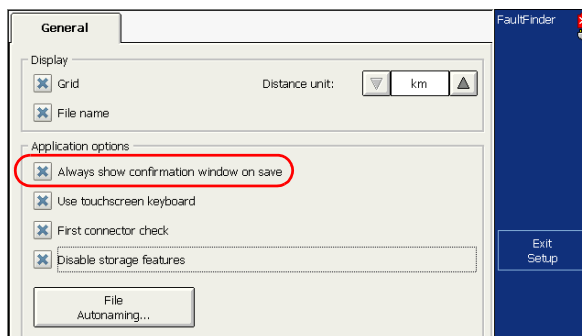

Note: You can also disable the confirmation of the file name by clearing the **Always show this window on save** check box directly from the **Save File** dialog box.

3. Press **Exit Setup** to return to the main window. The changes are applied automatically.

Testing Fibers in Fault Finder Mode

Enabling or Disabling the Storage Feature

Enabling or Disabling the Storage Feature

By default, the **Quick Save** button is displayed in the button bar. However, if you only want to perform quick tests without having to save the results, you may prefer to hide the **Quick Save** button.

To enable or disable the storage feature:

1. From the button bar, press **Setup**, then go to the **General** tab.
2. If you want to hide the **Quick Save** button, select the **Disable storage features** check box.

OR

If you want to display the button, clear the check box.

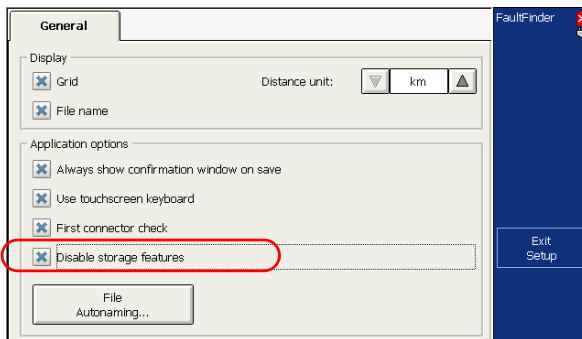

3. Press **Exit Setup** to return to the main window. The changes are applied automatically.

Enabling or Disabling the First Connector Check for Fault Finder

The first connector check feature is used to verify that the fibers are properly connected to the OTDR. It verifies the injection level and displays a message when a unusually high loss occurs at the first connection, which could indicate that no fiber is connected to the OTDR port. By default, this feature is not enabled.

Note: *The first connector check is only performed when you test at singlemode wavelengths.*

Note: *The first connector check parameter used in Fault Finder mode is independent from the one used in the other OTDR modes (Auto, Advanced and Template).*

Testing Fibers in Fault Finder Mode

Enabling or Disabling the First Connector Check for Fault Finder

To enable or disable the first connector check:

1. From the button bar, press **Setup** then select the **General** tab.
2. To enable the first connector check, select the **First connector check** check box.

OR

To disable it, clear the check box.

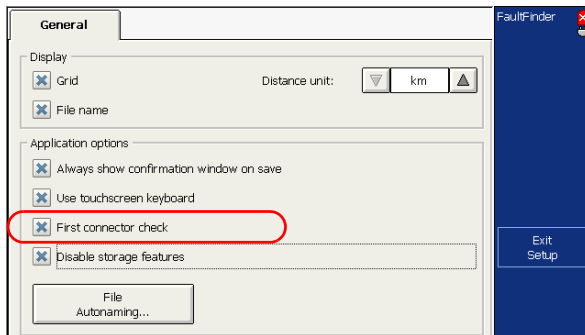

3. Press **Exit Setup** to return to the main window. The changes are applied automatically.

Enabling or Disabling the Touchscreen Keyboard

With the touchscreen keyboard, you can enter data without having to use an external keyboard. By default, this feature is enabled.

When you select a text or number box, the touchscreen keyboard or keypad appears automatically. However, you can disable it if you prefer using an external keyboard.

Note: *Hiding or displaying the touchscreen keyboard in Fault Finder mode has no effect on the way the touchscreen keyboard will be used in the other OTDR modes (Auto, Advanced and Template).*

To enable or disable the touchscreen keyboard:

1. From the button bar, press **Setup**, then select the **General** tab.

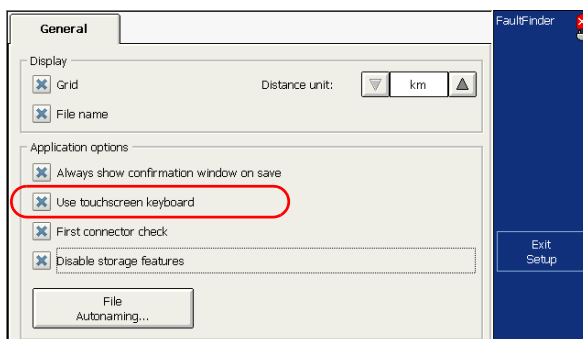

2. If you want to display the touchscreen keyboard, select the **Use touchscreen keyboard** check box.

OR

If you prefer to hide the keyboard, clear the check box.

3. Press **Exit Setup** to return to the main window. The changes are applied automatically.

Testing Fibers in Fault Finder Mode

Setting Trace Display Parameters

Setting Trace Display Parameters

You can change several trace display parameters:

- the grid: You can display or hide the grid appearing on the graph's background. By default, the grid is displayed.
- the file name in the trace display: The file name appears at the top of the trace display. By default, the file name is displayed.

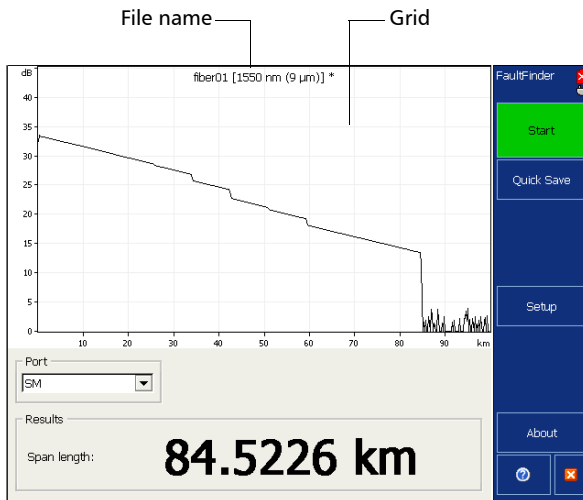

Note: The trace display settings used in Fault Finder mode are independent from the ones used in the other OTDR modes (Auto, Advanced and Template).

To set the trace display parameters:

1. From the button bar, press the **Setup** button, then select the **General** tab.
2. Select the check boxes corresponding to the item you want to display on the graph.

OR

To hide them, clear the check boxes.

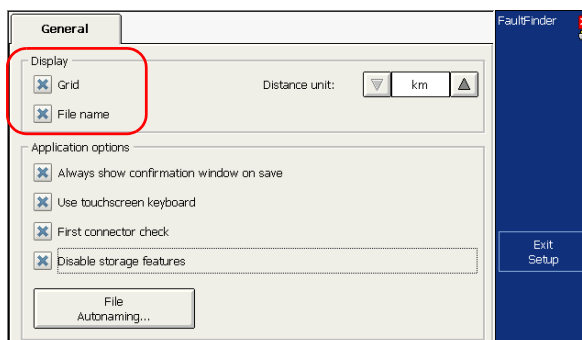

3. Press **Exit Setup** to return to the main window. The changes are applied automatically.

Testing Fibers in Fault Finder Mode

Selecting the Distance Units

You can select the distance units that will be used in the application.

The default distance units are the kilometers.

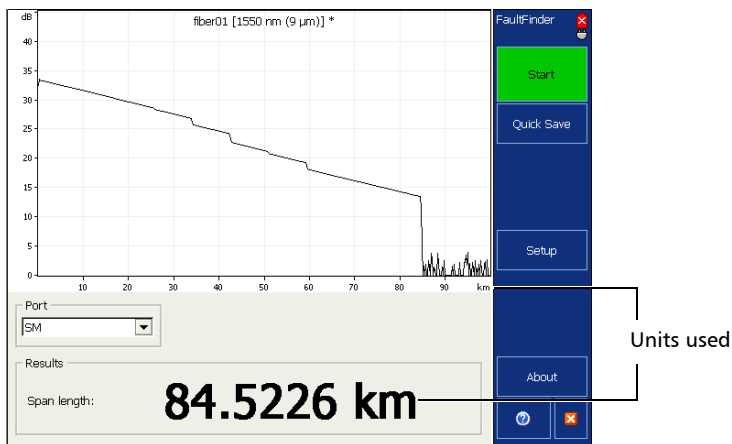

Note: *The distance units used in Fault Finder mode are independent from the ones used in the other OTDR modes (Auto, Advanced and Template).*

To select the distance units for your display:

1. From the button bar, select **Setup**.
2. From the **Setup** window, select the **General** tab.
3. From the **Distance units** list, select the item corresponding to the desired units.

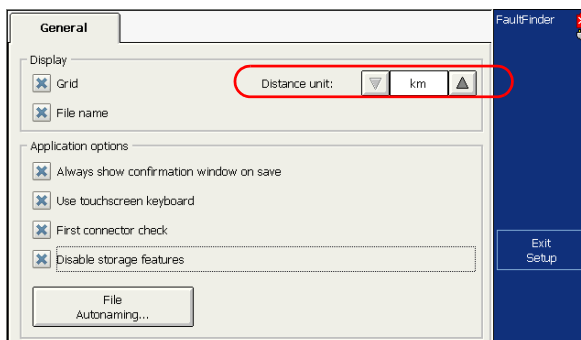

4. Press **Exit Setup**.

You return to the main window and the newly selected measurement unit appears everywhere these units are used.

9 **Customizing Your OTDR**

You can customize the appearance and behavior of your OTDR application.

Selecting the Default File Format

You can define the default file format the application will use when you save your traces.

By default, traces are saved in native (.trc) format, but you can configure your unit to save them in Bellcore (.sor) format.

If you select the Bellcore (.sor) format, the unit will create one file per wavelength (for example, TRACE001_1310.sor and TRACE001_1550.sor, if you included both 1310 nm and 1550 nm in your test). The native format contains all wavelengths in a single file.

You can only modify the file format from the **Save File** dialog box, which means you need to save at least one trace in the desired format before it becomes the new default file format.

Note: *The application will only display this dialog box if you have activated the feature to always be prompted when you save a file (see Enabling or Disabling File Name Confirmation on page 94).*

Customizing Your OTDR

Enabling or Disabling File Name Confirmation

To select the default file format:

1. From the **Main Menu** window, press **Quick Save**.
2. From the **Save File** dialog box, select the desired format.

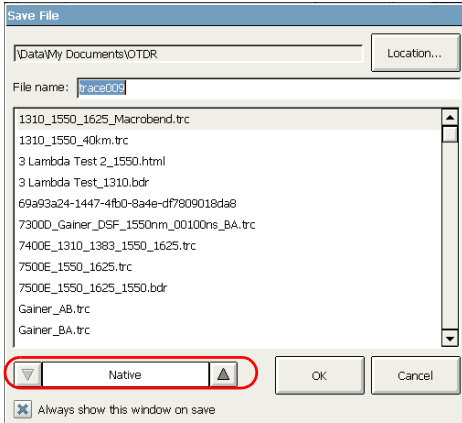

3. Press **OK** to save your file in the new format.

The next files will be saved in the new format.

Enabling or Disabling File Name Confirmation

By default, each time you save a file, the application prompts you to confirm the file name.

The application will use a file name based on autonaming settings (see *Naming Trace Files Automatically* on page 24).

Note: The file name confirmation parameter used in the Auto, Advanced, and Template modes is independent from the one used in the Fault Finder mode.

To enable or disable file name confirmation:

1. From the **Main Menu** window, press **OTDR Setup**, then select the **General** tab.
2. If you want to confirm file name each time you press **Quick Save**, select the **Always show confirmation window on save** check box.

OR

If you never want to be prompted, clear the check box.

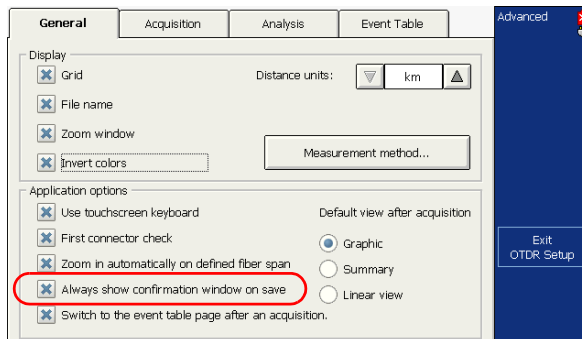

Note: You can also disable the confirmation of the file name by clearing the **Always show this window on save** check box from the **Save File** dialog box.

3. Press **Exit OTDR Setup** to return to the main window.

The changes are applied automatically.

Customizing Your OTDR

Selecting the Distance Units

You can select the measurement units that will be used throughout the application, except for certain values such as the pulse and the wavelength. Pulse values are expressed in seconds and wavelength in meters (nanometers).

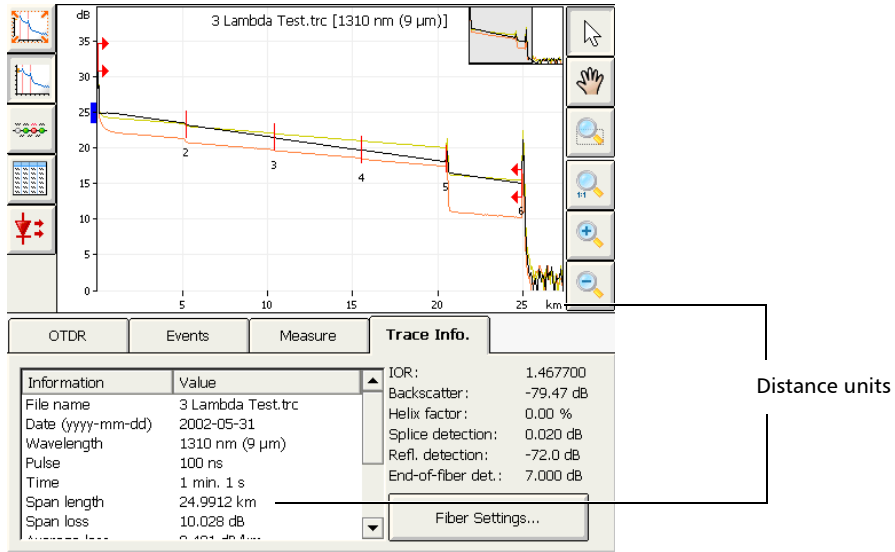

The default distance units are the kilometers.

Note: If you select **Kilometers (km)** or **Kilofeet (kft)**, **m** and **ft** may appear instead to display more precise measurements.

Note: The distance units used in Auto, Advanced, and Template modes are independent from the ones used in the Fault Finder mode.

Note: The attenuation of fiber sections is always presented in dBs per kilometer even if the distance units you selected are not the kilometers. This follows the standards of the fiber-optic industry that provides the attenuation values in dBs per kilometer.

To select the distance units for your display:

1. From the button bar, press **OTDR Setup**.
2. From the **OTDR Setup** window, select the **General** tab.
3. From the **Distance units** list, select the item corresponding to the desired distance units.

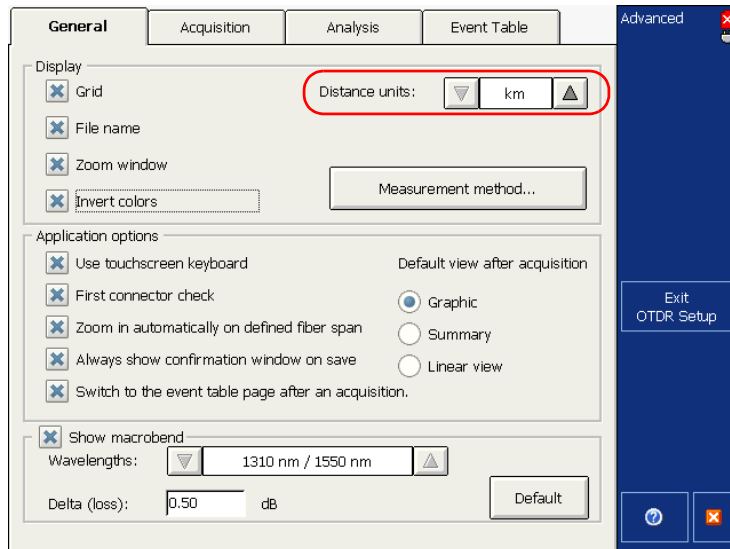

4. Press **Exit OTDR Setup**.

You return to the main window and the newly selected distance unit appears everywhere units are used.

Customizing Your OTDR

Customizing the Acquisition Distance Range Values

Customizing the Acquisition Distance Range Values

Note: This function is available in Advanced mode only.

If your OTDR model is FTB-7000D or later, you can customize the values associated with the **Distance** dial. Once the customization is complete, you are ready to set the distance range value for your test. For more information, see *Setting Distance Range, Pulse Width, and Acquisition Time* on page 45.

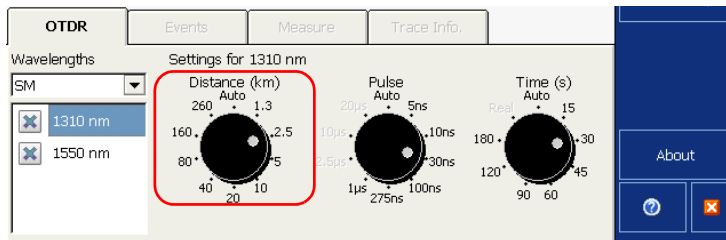

Note: The **Auto** value cannot be modified.

To customize the distance range values:

1. From the button bar, select **OTDR Setup**, then the **Acquisition** tab.
2. Press the **Custom Acquisition Parameters** button.

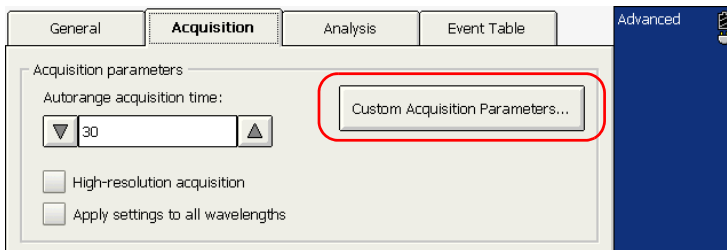

3. If your OTDR supports singlemode, multimode or filtered wavelengths, specify the desired fiber type.

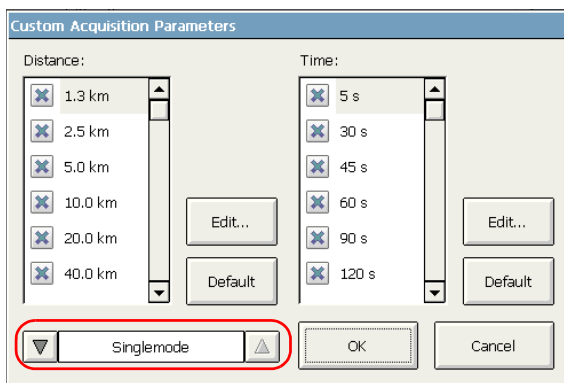

4. From the **Distance** list, select the value you want to modify (the value will become highlighted), then press the **Edit** button.

Note: You can revert to factory values by pressing the **Default** button.

5. In the displayed dialog box, enter the new value and confirm with **OK**.

Customizing the Acquisition Time Values

Note: This function is available in Advanced mode only.

You can customize the values associated with the **Time** dial. The acquisition time values represent the time during which the OTDR will average acquisitions.

If your OTDR model is FTB-7000D or later, you can even define acquisition time as short as 5 seconds (10 seconds for older modules).

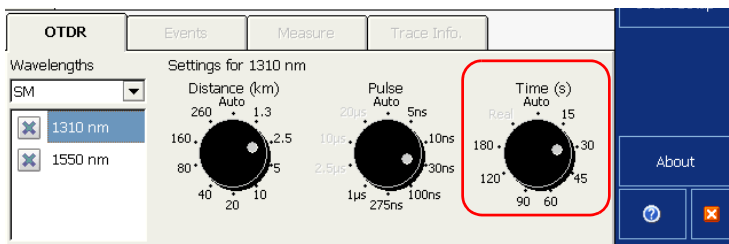

Note: The **Auto** and **Real** values cannot be modified.

You can customize the acquisition time to improve the signal-to-noise ratio (SNR) of the trace and enhance the detection of low-level events. The SNR improves by a factor of two (or 3 dB) each time the acquisition time is increased by a factor of four.

To customize the acquisition time values:

1. From the button bar, select **OTDR Setup**, then the **Acquisition** tab.
2. Press the **Custom Acquisition Parameters** button.

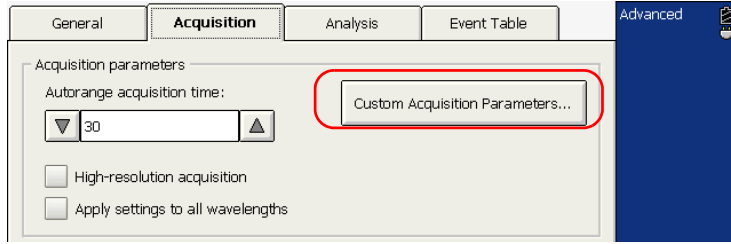

3. From the **Time** list, select the value you want to modify (the value will become highlighted), then press the **Edit** button.

Note: You can revert to factory values by pressing the **Default** button.

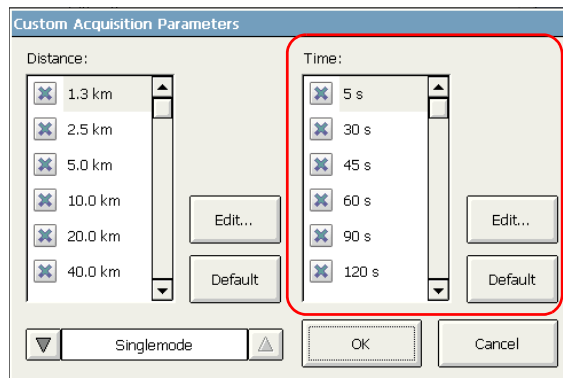

4. In the displayed dialog box, enter the new value and confirm with **OK**.

Customizing Your OTDR

Enabling or Disabling the Touchscreen Keyboard

Enabling or Disabling the Touchscreen Keyboard

With the touchscreen keyboard, you can enter data without having to use an external keyboard. By default, this feature is enabled.

When you select a text or number box, the touchscreen keyboard or keypad appears automatically. However, you can disable it if you prefer using an external keyboard.

Note: *Hiding or displaying the touchscreen keyboard in Auto, Advanced, and Template modes has no effect on the way the touchscreen keyboard will be used in the Fault Finder mode.*

To enable or disable the touchscreen keyboard:

1. From the **Main Menu**, select **OTDR Setup**, then select the **General** tab.
2. If you want to display the touchscreen keyboard, select the **Use touchscreen keyboard** box.

OR

If you prefer to hide the keyboard, clear the check box.

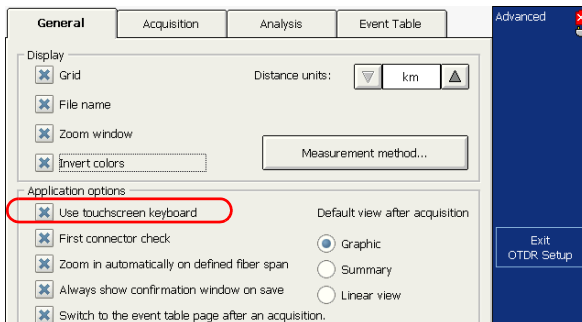

3. Press **Exit OTDR Setup** to return to the **Main Menu** window. The changes are applied automatically.

Displaying or Hiding the Optional Features

If you have *not* purchased the optional software package, since you cannot use the optional features, you may prefer to hide them (macroband detection, linear view).

Note: *You cannot hide the optional features if you purchased the software package.*

To display or hide the optional features:

1. From the button bar, press **OTDR Setup**.
2. In the **General** tab, under **Display**, clear the **Show all optional software features** check box to hide the options

OR

Select the check box to display them.

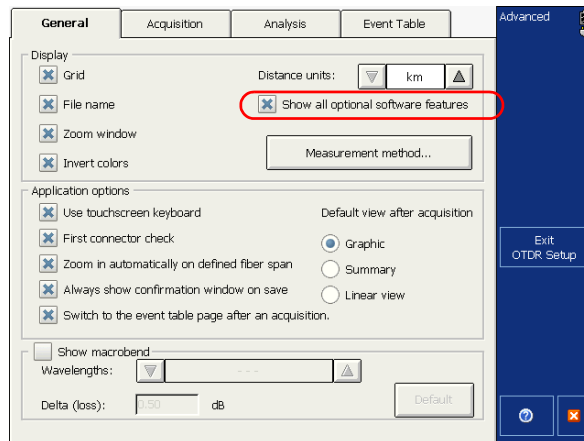

3. From the button bar, press **Exit OTDR Setup** to return to the main window.

The changes are applied automatically.

10 **Analyzing Traces and Events**

Once the acquired trace is analyzed, it appears in the trace display and the events are displayed in the events table at the bottom of the screen. The trace display and events table are explained in the following sections. You can also reanalyze existing traces. For information on the various file formats you can open with the application, see *Opening Trace Files* on page 159.

There are many ways to view the results:

- Graph view
- Linear view (optional)
- Summary table

From the trace display and linear views, you can also access the following tabs to have more information:

- Events
- Trace info

Analyzing Traces and Events

Graph View

Graph View

The events, that are detailed in the events table (see *Events Tab* on page 112), are marked by numbers along the displayed trace.

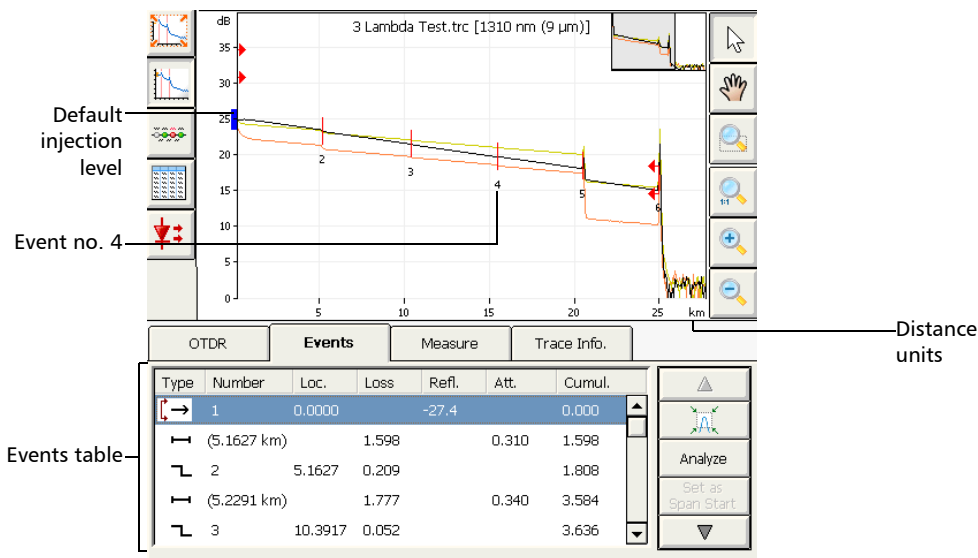

Some items in the trace display are always visible, while others will appear only if you choose to display them. The contents of the graph area changes according to the selected tab.

The blue rectangle on the Y axis (relative powers) indicates the proper injection level range for the defined test pulse.

You can change trace display parameters (such as the grid and zoom window display). For more information, see *Setting Trace Display Parameters* on page 126.

You can view all of the traces, in turn, in both the **Trace Info** pane and the trace display with the navigation buttons. For more information, see *Displaying or Hiding a Trace* on page 130.

Each wavelength is displayed in a different color. The colors are assigned dynamically. Wavelengths of the reference traces are also displayed using the colors corresponding to those of the main trace, but with a darker shade.

Analyzing Traces and Events

Linear View

Linear View

Note: This function is available with the optional software package only.

In the linear view, the events are displayed sequentially, from left to right.

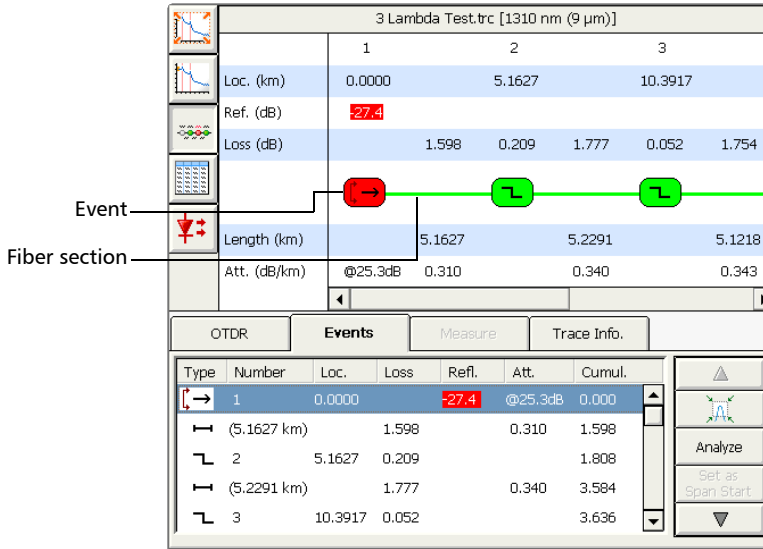

- Each bubble represents an event. Each horizontal line that “links” two bubbles represents a fiber section. Bubbles and lines will be displayed in colors only if the **Mark faults in event table** item is selected in OTDR setup (green for pass, red for fail, grey or black for events and fiber sections appearing outside the current fiber span). Otherwise, all events will be displayed in grey and fiber sections in black.
- When you select an event or a fiber section in the events table, the linear view automatically scrolls to display the element.
- You can also select a bubble or an horizontal line and the corresponding item will be selected in the events table.

- You can view, in turn, the reference trace and the main trace using the **Next Trace** button.
- If you press a bubble or an horizontal line and hold for a few seconds, the application will display a tooltip identifying the item (for example, Reflective fault). If the bubble corresponds to a merged event, you will also see details about the “sub-events”, including the event types.
- The **Measure** tab is not available when the linear view is displayed.
- If the **Zoom in automatically on defined fiber span** item is selected (**OTDR Setup > General** tab), the first element that will be visible in the linear view is the span start. However, it is possible to manually scroll to view events that would be located before the span start.
- The linear view cannot be displayed when the events table is empty. Traces must have been analyzed before you can see them in the linear view.
- If you configured the application to show the macrobends (**OTDR Setup > General** tab), when you display the trace corresponding to the greatest wavelength of the selected wavelength combination, you can view a line containing information about macrobends. For example, if the wavelength combination is 1310 nm/1550 nm, macrobend information will appear for the 1550 nm trace.

When macrobends are detected, icons will be displayed to identify them. Colors of the bubbles correspond to the status of the events (green for pass, red for fail) and do not change if macrobends are detected.

To display the linear view:

From the main window, press the  button.

Note: *To display the linear view as the default view after the acquisitions are all performed (at all the selected wavelengths) and the analysis of the last wavelength is complete, see [Selecting the Default View](#) on page 119.*

Summary Table

Note: This function is available both in Advanced and Auto modes.

The summary table gives, for each wavelength, the global status of the results (pass: no results exceed the thresholds or fail: at least one result exceeds the thresholds), the span loss and span ORL values. The span length (distance between span start and span end) is also displayed, except if a continuous fiber is detected for all wavelengths. In this case, “Continuous fiber” will be displayed instead.

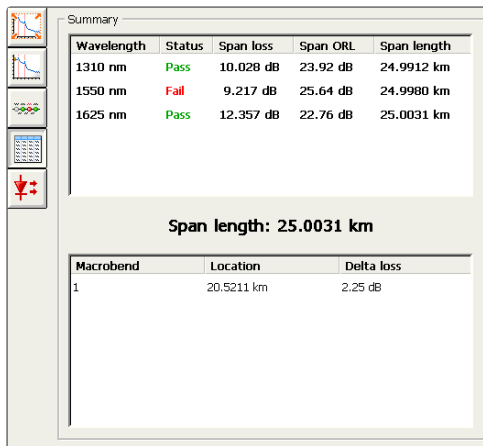

Wavelength	Status	Span loss	Span ORL	Span length
1310 nm	Pass	10.028 dB	23.92 dB	24.9912 km
1550 nm	Fail	9.217 dB	25.64 dB	24.9980 km
1625 nm	Pass	12.357 dB	22.76 dB	25.0031 km

Span length: 25.0031 km

Macrobend	Location	Delta loss
1	20.5211 km	2.25 dB

- When you select an element in the summary table (element is highlighted), if you double-tap or press Enter (on the unit’s knob), the application automatically switches to the graph view. The graph is displayed with “full trace” zoom, except if the status of the selected wavelength is “fail”. In this case, the application zooms in on the first event or fiber section for which the status is “fail”. In the graph view, the events tab is automatically selected, allowing you to switch to another event either manually or using the knob.
- The summary table shows only the information of the main trace, not the information of the reference trace.

- Since the summary table shows the information for all the wavelengths of the main trace only, the **Next Trace** button is not available.
- The summary table cannot be displayed when the events table is empty or if the trace contains only a span start. Traces must have been analyzed before you can see them in the summary table.
- If you close a trace file when the summary table is displayed, the application will switch to the graph view until you open a new trace file that can be displayed.
- If you purchased the macrobend finder option and configured the application to show the macrobends (**OTDR Setup > General** tab), the information will appear at the bottom of the summary table.
- If no macrobends were detected, the application displays “No macrobend has been detected” instead of the information on the macrobends.
- If the traces that have been analyzed do not match the pair of wavelengths selected in the OTDR setup for the detection of macrobends (for example, you perform an acquisition at 1310 nm and 1625 nm, and the wavelengths selected for the detection of macrobends are 1310 nm/1550 nm), the application displays “Macrobend parameter is not valid”.
- When you select an element in the macrobend table (element is highlighted), if you double-tap or press Enter (on the unit’s knob), the application automatically switches to the graph view. The application zooms in on the first event that caused the selected macrobend. In the graph view, the events tab is automatically selected, allowing you to switch to another event either manually or using the knob.

Analyzing Traces and Events

Events Tab

To display the summary table:

From the main window, press the  button.

Note: *To display the summary table as the default view after the acquisitions are all performed (at all the selected wavelengths) and the analysis of the last wavelength is complete, see [Selecting the Default View](#) on page 119.*

Events Tab

This tab is available when the graph view and the linear view (optional) are displayed. You can view information about all detected events on a trace and fiber sections by scrolling through the events table. In graph view, when you select an event in the events table, marker **A** appears on the trace over the selected event. When the selected event is a fiber section, this fiber section is delimited by two markers (**A** and **B**). For more information on markers, see [Using Markers](#) on page 165.

These markers pinpoint an event or a fiber section, depending on what is selected in the events table. You can move markers directly by selecting an element in the events table or on the graph.

The events table lists all the events detected on the fiber. An event can be defined as the point at which change in the transmission properties of light can be measured. Events can consist of losses due to transmission, splices, connectors or breaks. If the event is not within the established thresholds, its status will be set to “fail”.

In Template mode, the events table shows the events of the main trace.

OTDR		Events	Measure	Trace Info.		
Type	Number	Loc.	Loss	Ref.	Att.	Cumul.
→	1	0.0000		-27.4		0.000
	(5.1627 km)		1.598		0.310	1.598
↘	2	5.1627	0.209			1.808
	(5.2291 km)		1.777		0.340	3.584
↘	3	10.3917	0.052			3.636

Non-Reflective Event

Tooltip identifying the selected item

If you press and hold the row corresponding to a specific event or fiber section for a few seconds, the application will display a tooltip identifying the item (for example, Non-reflective fault). In the case of a merged event, you will also see details about the “sub-events”.

If an asterisk appears next to the event symbol, the tooltip will also show “(*:Modified)” to indicate that this event has been modified manually. If the asterisk appears next to the event number, “(*:Added)” will appear to indicate that this event has been inserted manually.

For each item listed in the events table, information is displayed:

- **Type:** Various symbols are used to describe different event types. For a more detailed description of symbols, see *Description of Event Types* on page 297.
- **Number:** Event number (a sequential number assigned by the OTDR test application) or, in parentheses, the length of a fiber section (the distance between two events).
- **Loc.:** Location; that is, distance between the OTDR and the measured event or between the event and the beginning of the fiber span.
- **Loss:** Loss in dB for each event or fiber section (calculated by the application).

Analyzing Traces and Events

Events Tab

- **Refl.:** Reflectance measured at each reflective event along the fiber.
- **Att.:** Attenuation (loss/distance) measured for each fiber section.

Note: *The attenuation value is always presented in dB per kilometers even if the distance units you selected are not the kilometers. This follows the standards of the fiber-optic industry that provides the attenuation values in dB per kilometers.*

- **Cumul.:** Cumulative loss from the trace span start to span end; the running total is provided at the end of each event and fiber section.

Cumulative loss is calculated for the events displayed in the events table, excluding those that are hidden. For a more accurate link loss value, refer to the loss measurement displayed in the **Trace Info.** tab.

If you want to modify events or fiber sections, see *Modifying Events* on page 138, *Inserting Events* on page 142, and *Changing the Attenuation of Fiber Sections* on page 146.

To quickly locate an event in the events table:

1. Ensure that the  button is selected in the zoom button bar.
2. Select the event on the trace.

The list scrolls automatically to the event you selected.

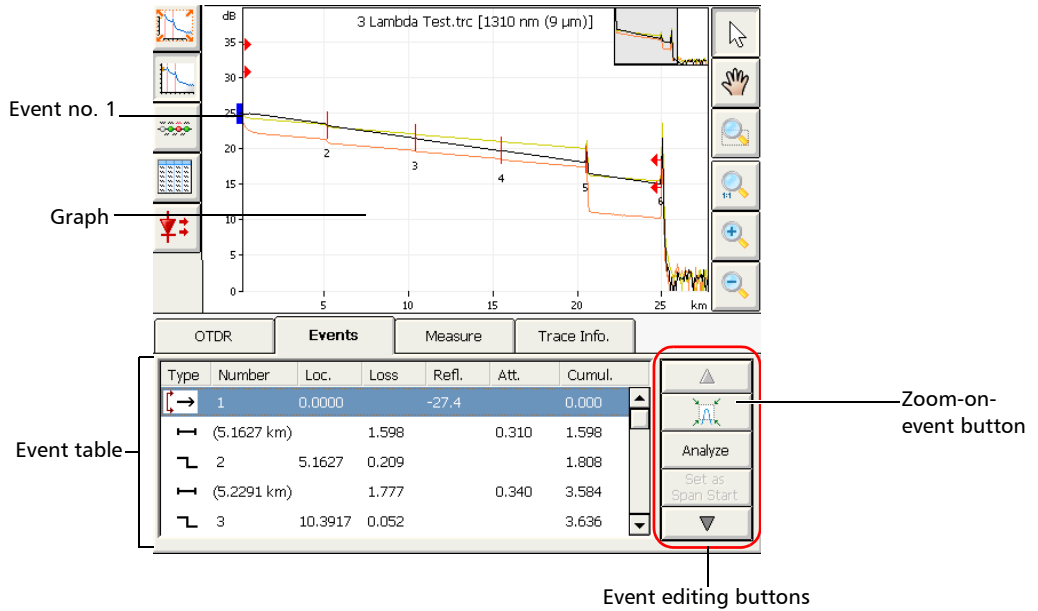

The screenshot shows the OTDR software interface. At the top, a graph displays a trace with several events marked by red arrows and numbered 1 through 6. The y-axis is labeled 'dB' and ranges from 0 to 35. The x-axis is labeled 'km' and ranges from 0 to 25. Below the graph is a tabbed interface with 'Events' selected. The 'Events' table is shown below, with the following data:

Type	Number	Loc.	Loss	Refl.	Att.	Cumul.
↔	1	0.0000		-27.4		0.000
↔	2	(5.1627 km)	1.598		0.310	1.598
↔	3	(5.2291 km)	1.777		0.340	3.584
↔	4	10.3917	0.052			3.636

Labels in the image point to various UI elements: 'Event no. 1' points to the first event on the trace; 'Graph' points to the main plot area; 'Event table' points to the table below the graph; 'Zoom-on-event button' points to a button with a magnifying glass icon in the right-hand toolbar; and 'Event editing buttons' points to a set of buttons (Analyze, Set as Span Start) located below the event table.

Measure Tab

The application shows two, three or four markers: **a**, **A**, **B**, and **b**, depending on the button you pressed under **Results**.

These markers can be repositioned along the trace to calculate loss, attenuation, reflectance, and optical return loss (ORL).

You can reposition all markers by using the controls in the **Markers** section.

You can drag them directly from the trace display. You can also use

 from the keypad to select the desired marker and

move it with the selection dial located on the front of the FTB-200 v2

Compact Modular Platform. Selecting marker **A** or **B** will move the **a-A** or **B-b** pair.

For more information on how to perform manual measurements, see *Analyzing the Results Manually* on page 163.



Trace Info. Tab

The information about all the trace files (including the reference) can be displayed.

You can view all of the traces, in turn, in both the **Trace Info** pane and the trace display with the navigation buttons. For more information, see *Displaying or Hiding a Trace* on page 130.

Displaying the Graph in Full Screen

You can display the graph in full screen at any time, even when an acquisition is underway. The graph will keep the same display options as in normal view (grid, file name, zoom window, inverted colors).

You can start acquisitions directly (via the  |  button located on the front of your unit) without having to go back to normal view first. You can switch from one wavelength to another.

The information that is displayed at the bottom of the graph depends on the tab that was selected when you switched to full-screen mode. The table below gives an overview of the information that is available in each case.

Tab that was selected	Displayed information in full-screen mode
OTDR	Acquisition parameters (wavelengths appearing on the list correspond to those that are selected in the tab).
Events	A table of events that can be viewed one event at a time.
Measure	Marker information and either the four-point event loss, attenuation, reflectance, or ORL measurement, depending on the type of measurement that is selected in the tab.
Trace Info.	No further information is displayed. Only the graph is available.

As soon as a trace is displayed (new acquisition or existing file), zoom controls are available (see *Using Zoom Controls* on page 123).

Note: *If you want to use the zoom-on-event feature, you must select the*



*button from the **Events** tab before switching to full-screen mode.*

Analyzing Traces and Events

Displaying the Graph in Full Screen

If you want to view a table of events once the acquisitions are complete, you must select the **Events** tab or activate the option to display the event table (from **OTDR Setup**) before switching to full-screen mode.

Once all acquisitions are complete, the application will automatically switch to the defined default view (see *Selecting the Default View* on page 119). If you prefer that the graph remains in full screen after the acquisitions are complete, ensure that the default view is set to **Graph in OTDR Setup**.

To display the graph in full screen:

From the main window, press the  button.

The graph is now displayed in full-screen mode.

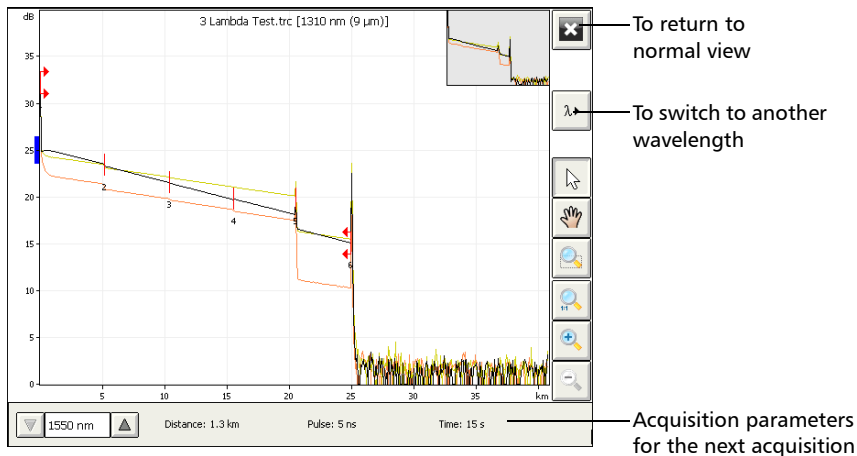

Selecting the Default View

You can select which view will be displayed by default once all the acquisitions are performed (at all the selected wavelengths) and the analysis of the last wavelength is complete.

The table below indicates in which OTDR modes (Auto, Advanced, Template) a particular view can be displayed.

View	OTDR modes for which view is available	Remarks
Graph	<ul style="list-style-type: none"> ➤ Auto ➤ Advanced ➤ Template 	<p>Default view.</p> <p>For more information, see <i>Graph View</i> on page 106</p>
Linear	<ul style="list-style-type: none"> ➤ Auto ➤ Advanced ➤ Template 	<p>Available with the optional software package only.</p> <p>In this view, events are displayed sequentially, from left to right.</p> <p>Macrobends are identified with symbols on the trace corresponding to the greatest wavelength of the pair of wavelengths.</p> <p>For more information, see <i>Linear View</i> on page 108.</p>

Analyzing Traces and Events

Selecting the Default View

View	OTDR modes for which view is available	Remarks
Summary table	<ul style="list-style-type: none">➤ Auto➤ Advanced	<p>This table gives, for each wavelength, the pass/fail status of the results, the span loss and span ORL values. Span length is also displayed.</p> <p>If you purchased the option, information on macrobends will be displayed.</p> <p>For more information, see <i>Summary Table</i> on page 110.</p>

Note: In Fault Finder mode, only the graph is available.

To select the default view:

- 1.** From the button bar, select **OTDR Setup**, then the **General** tab.
- 2.** Under **Default view after acquisition**, select the desired view.
- 3.** Press **Exit OTDR Setup** to return to main window.

The application will automatically switch to the selected view when you perform the next acquisitions.

Automatically Displaying the Event Table after Acquisitions

You may want the application to automatically switch to the event table once all acquisitions are complete. This could be particularly useful when you work in full-screen mode (see *Displaying the Graph in Full Screen* on page 117) if you want to view the event table without having to go back in normal view mode.

To display the event table after acquisitions:

1. From the button bar, select **OTDR Setup**, then the **General** tab.
2. Under **Application options**, select **Switch to the event table page after an acquisition**.

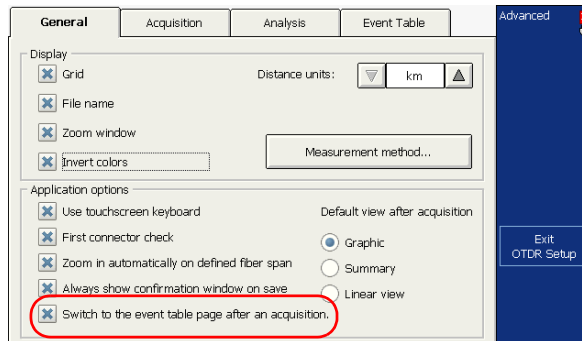

3. Press **Exit OTDR Setup** to return to main window.

The application will automatically display the events table at the end of the next acquisitions.

Automatically Zooming in on the Fiber Span

Note: *This function is available both in Advanced and Template modes.*

You can set the trace display to show only the span start to the span end of the trace in full-trace view. By default, this feature is not selected.

To automatically zoom in on the fiber span:

1. From the button bar, select **OTDR Setup**.
2. From the **OTDR Setup** window, select the **General** tab.
3. Under **Application options**, select **Zoom in automatically on defined fiber span** to automatically zoom on the fiber span in the trace display when a trace is opened or selected, or after trace analysis.

OR

Clear the box to leave the zoom level as is.

Note: *Zoom in automatically on defined fiber span is active only when in full-trace view, not when you have zoomed in on a trace.*

Even if the application automatically zooms in on the fiber span, you can adjust the zoom manually. You can even zoom in on events located outside the fiber span. For more information on how to use the zoom controls see *Using Zoom Controls* on page 123.

Using Zoom Controls

Use the zoom controls to change the scale of the trace display.

You can zoom in on or out of the graph using the corresponding buttons or let the application automatically adjust the zoom on the currently selected event from the events table (only available when the events window is displayed).

You can quickly zoom in on or out of the selected event.

You can also return to the original graph value.

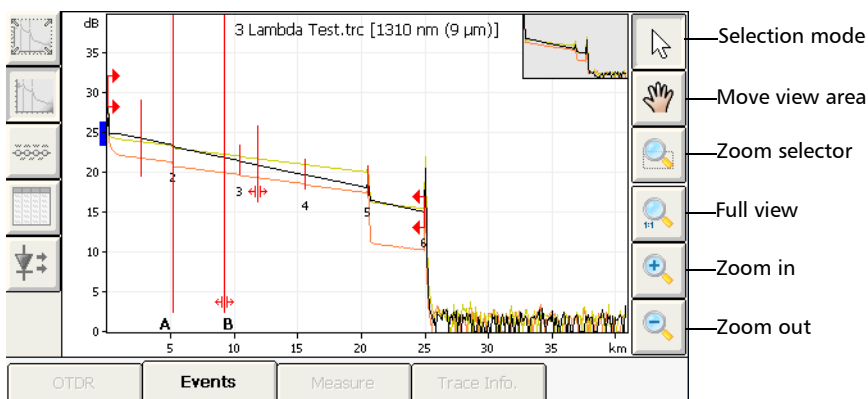

Note: You cannot move the markers with the  button.

Analyzing Traces and Events

Using Zoom Controls

- When you manually zoom in or out on a trace, the application will apply the new zoom factor and marker positions to the other traces (wavelengths) of a same file and on the reference file, if applicable. Both the zoom factor and marker positions will be saved along with the trace (same settings for all wavelengths).
- When you zoom in or out on the selected event, the application keeps the zoom on this event until you select another event or change zoom or marker positions (via the **Measure** tab). You can select a different event for each wavelength (for example, event 2 at 1310 nm and event 5 at 1550 nm). The selected events will be saved along with the trace.

Note: *In Template mode, the zoom factor and marker positions correspond to those of the reference trace.*

If you want the application to automatically zoom on the defined fiber span, see *Automatically Zooming in on the Fiber Span* on page 122.

To view specific portions of the graph:



- You can define which portion of the graph will be visible by selecting the  button and dragging the graph with the stylus or your finger.

This could be useful, for example, if you want to zoom in on events located outside the defined fiber span.

- The  button is the zoom selector. It allows you to select whether the zooming will be performed according to the horizontal axis, the vertical axis, or both.

Press and hold this button to select the zooming direction in the menu. Then, define the zoom area with the stylus or your finger (a rectangle with dotted lines will appear to help you define the area). Once you release the stylus, the application automatically zooms in on the graph

according to the zooming type you have selected. All of the other zoom buttons (except for the zoom on selected event button) will reflect your selection and behave accordingly.

- You can zoom in or out on the graph by first using, respectively, the  or the  button, and then by pressing the location where you want to zoom on the graph with the stylus or your finger. The application automatically adjusts the zoom by a factor 2 around the point that was pressed.

To revert to the complete graph view:

Press the  button.

Note: *If the Zoom in automatically on defined fiber span feature is selected in the OTDR setup, the application will zoom in between span start and span end.*

To automatically zoom in on the selected event:

1. Go to the **Events** tab.
2. From the events table, select the desired event.
3. Press the  button to zoom in. Press the button again to zoom out.

Analyzing Traces and Events

Setting Trace Display Parameters

Setting Trace Display Parameters

Once you have launched the desired trace acquisition mode (Automatic, Advanced, or Template), you can change several trace display parameters:

- the grid: You can display or hide the grid appearing on the graph's background. By default, the grid is displayed.
- the graph background: You can display the graph with a black (invert color feature) or a white background. By default, the background is white.
- the zoom window: The zoom window shows you which portion of the graph is being magnified. By default, the zoom window is displayed.
- the file name in the trace display: The file name appears at the top of the trace display. By default, the file name is displayed.

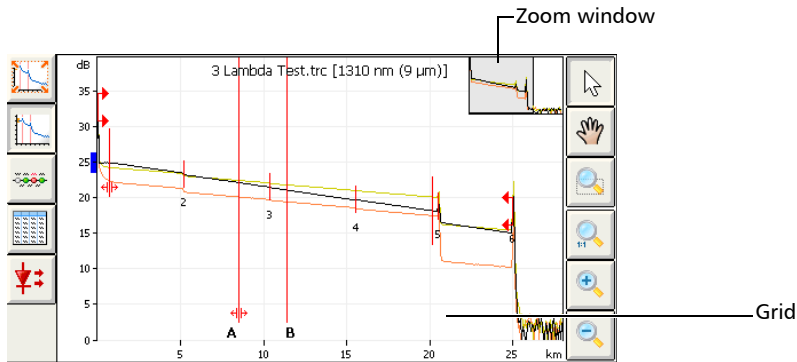

Note: The trace display settings used in Auto, Advanced, and Template modes are independent from the ones used in the Fault Finder mode.

To set the trace display parameters:

1. From the button bar, press the **OTDR Setup** button, then select the **General** tab.
2. Select the boxes corresponding to the item you want to display on the graph.

OR

To hide them, clear the boxes.

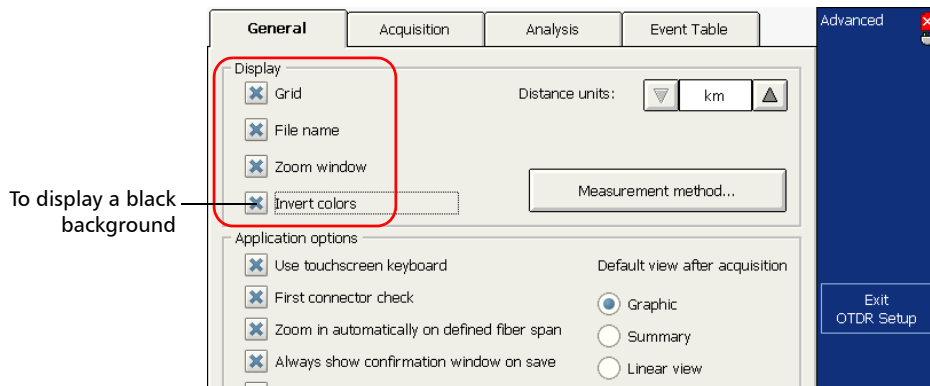

3. Press **Exit OTDR Setup** to return to the main window.

The changes are applied automatically.

Customizing the Event Table

Note: This function is available both in Advanced and Auto modes.

You can include or exclude items from the events table to better suit your needs.

Note: Hiding the fiber sections will not delete these items.

- **Fiber sections:** You can display or hide fiber sections in the events table and in the linear view, depending on the types of values you want to display.
- **Launch level:** In the events table, the Launch Level event is represented by the → icon. In the **Att.** column, the injection level value for that event is identified by the @ symbol. You can hide the injection level value and symbol from the **Att.** column, but not the → icon.

OTDR		Events		Measure		Trace Info.	
Type	Number	Loc.	Loss	Refl.	Att.	Cumul.	
→	1	0.0000		-27.4		0.000	 Analyze Set as Span Start ▼
↔	(5.1627 km)		1.598		0.310	1.598	
↘	2	5.1627	0.209			1.808	
↔	(5.2291 km)		1.777		0.340	3.584	
↘	3	10.3917	0.052			3.636	

- **Including span start and span end:** When applicable, the application will include the losses caused by the span start and span end events to the span ORL and span loss values.

If you activated the pass/fail test (see *Setting Pass/Fail Thresholds* on page 53), span-start and span-end events will be taken into account when determining the status (pass/fail) of splice and connector loss and reflectance.

To customize the events table appearance:

1. From the **OTDR Setup** window, select the **Event Table** tab.
2. Select the boxes corresponding to the item you want to display or include in the table.

OR

To hide them, clear the boxes.

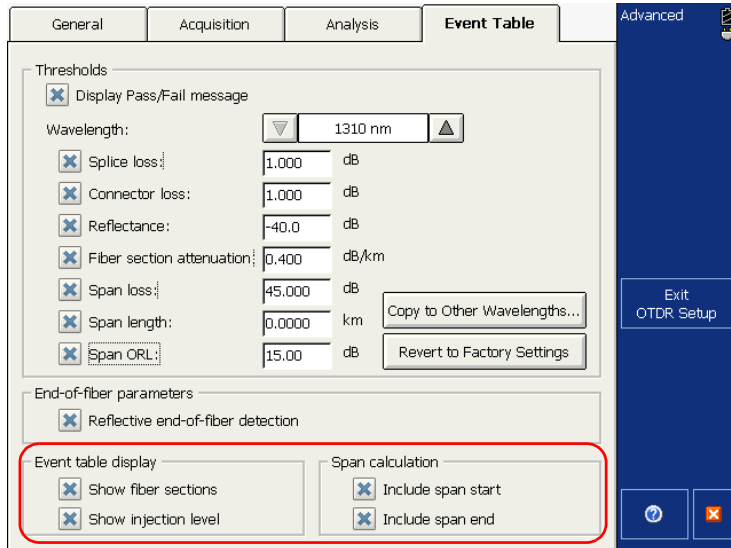

3. Press **Exit OTDR Setup**.

Displaying or Hiding a Trace

There are two ways of displaying or hiding traces in the OTDR test application.

- You can view, in turn, all the trace files you have opened, including main and reference traces, as well as multiwavelength traces.
- You can select the fibers and the wavelengths (for multiwavelength files) that will be available when using the navigation button. You can also specify which trace will be displayed (current trace). By default, the application takes the last item from the list of trace files you have just opened.

To display or hide traces in turn:

Press the **Next Trace** button to switch from one fiber to another or from one wavelength to another (for multiwavelength files).

You can also use  |  from the keypad.

To specify which traces to display or hide:

1. From the button bar, press **Storage**.

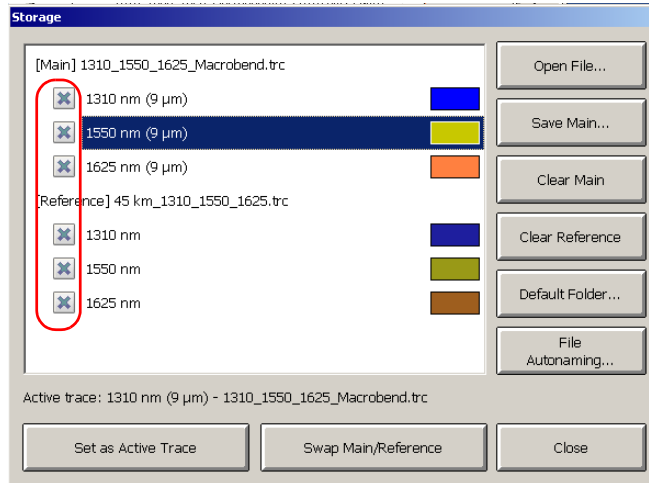

2. Select the boxes corresponding to the traces to display.

OR

Clear the boxes to hide them.

Note: A hidden trace cannot be displayed with the navigation button. In multiwavelength trace files, you can show or hide traces independently.

3. From the list of traces, select the row corresponding to the trace you want to set as the current trace (the row will become highlighted) and press the **Set as Active Trace** button.

The trace will turn black in the display to indicate that it was selected.

Note: In Template mode, the **Set as Active Trace** button is not available.

Clearing Traces from the Display

Note: This function is available in Advanced mode only.

Note: Clearing traces from the display does not delete them from the disk.

Although the test application automatically opens the last trace files used, you can clear the screen and launch new acquisitions. If a trace you acquired (main or reference) does not meet your requirements, you can clear that trace and start over.

To clear traces from the display:

1. From the button bar, press **Storage**.
2. From the **Storage** dialog box, press **Clear Main** or **Clear Reference**.

If you had already acquired or modified (but not stored) some traces, a warning message appears for each trace (even if the trace is hidden) asking you if you want to save it or not. Press **Yes** to save the trace.

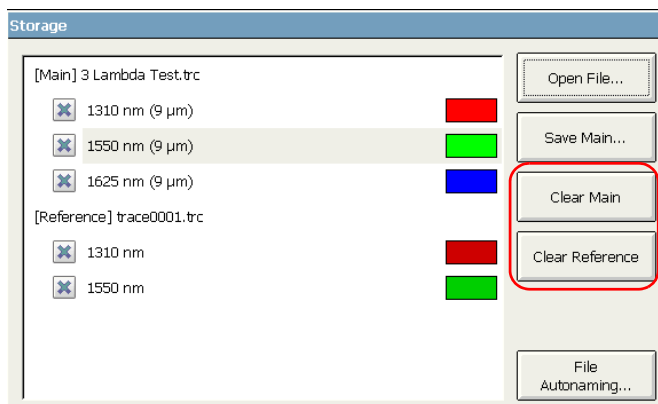

3. Press **Close** to return to the main window. You can now acquire a new trace. For more information, see *Testing Fibers in Advanced Mode* on page 37.

Viewing and Modifying Current Trace Settings

You can view the trace parameters and modify them at your convenience.

Note: *Parameter modification is only possible in Advanced mode.*

You can modify the index of refraction (IOR) also known as group index, Rayleigh backscatter (RBS) coefficient and helix factor for the displayed trace.

Modifications you make are only applied to the current trace (that is, to a particular wavelength), not to all traces.

The application will only prompt you to reanalyze the trace if you modify the RBS coefficient (no analysis necessary when you modify the IOR or helix factor).

Analyzing Traces and Events

Viewing and Modifying Current Trace Settings

To view trace settings:

Go to the **Trace Info.** tab.

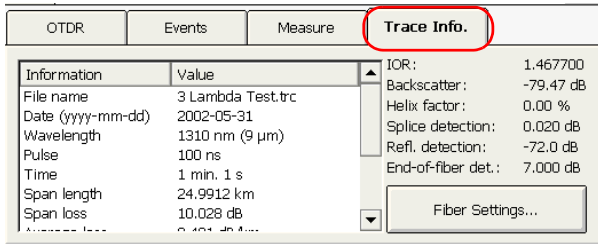

Note: Even if more than one trace is available, the **Trace Info.** tab only shows one at a time. To display the traces in turn, press **Next Trace** in the toolbar. The active trace appears in black in the trace display.

These parameters are displayed:

- **Wavelength:** Test wavelength and type of fiber used: (singlemode) or (multimode).
- **Range:** Distance range used to perform the acquisition.
- **Pulse:** Pulse width used to perform the acquisition.
- **Time:** Duration (either in minutes or seconds) of the acquisition.
- **Span length:** Measured length of the total fiber span between span start and span end.
- **Span loss:** Total measured loss of the fiber calculated either between the span start and the span end, or on the total fiber span, depending on the option you have selected in the **Setup** window.
- **Average loss:** Average loss of the total fiber span, indicated as a function of distance.
- **Average splice loss:** Average of all non-reflective events between span start and span end.

- **Max. splice loss:** Maximum loss of all non-reflective events between span start and span end.
- **Span ORL:** ORL calculated either between the span start and the span end, or on the total fiber span, depending on the option you have selected in the **Setup** window.
- **High resolution:** High-resolution feature was selected to perform the acquisition. For more information, see *Enabling the High-Resolution Feature* on page 49.
- **Helix factor:** Helix for the displayed trace. If you modify this parameter, the trace distance measurements will be adjusted.
- **IOR:** Refraction index of the displayed trace, also known as group index. If you modify this parameter, the distance measurements for the trace will be adjusted. You can enter an IOR value directly or let the application calculate it with the distance between span start and span end you provide. The IOR value is displayed with six digits after the decimal point.
- **Backscatter:** Rayleigh backscatter coefficient setting of the displayed trace. If you modify this parameter, the reflectance and ORL measurements for the trace will be adjusted.
- **Splice detection:** Current setting for detecting small non-reflective events during trace analysis.
- **Refl. detection:** Current setting for detecting small reflective events during trace analysis.
- **End-of-fiber det.:** Current setting for detecting important event loss that could compromise signal transmission during trace analysis.

Analyzing Traces and Events

Viewing and Modifying Current Trace Settings

To modify the IOR, RBS coefficient, and helix factor parameters:

1. From the main window, go to the **Trace Info.** tab.

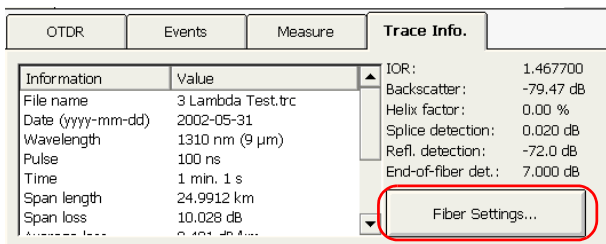

2. Press the **Fiber Settings** button.
3. Enter the desired values for the current trace in the appropriate boxes.

OR

If you want to revert a particular item to its default value, press the **Default** button appearing next to this item.

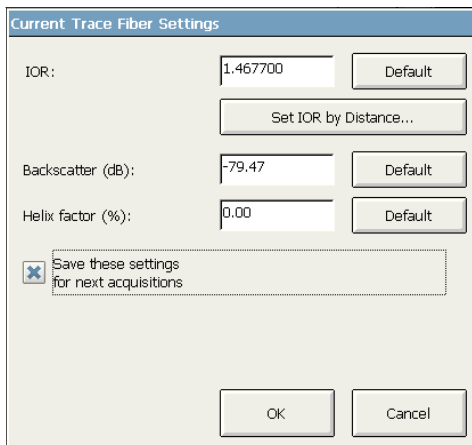

Note: Except for the fiber type, modifications you make will only be applied to the current trace (that is, to a particular wavelength), not to all traces.

- You can change the fiber type of a multimode trace. The application will adjust the fiber type of *all* multimode wavelengths (traces).
 - Unless you are absolutely sure of the different parameter values, revert to default values to avoid fiber setting mismatches. You should do the same for other multimode wavelengths.
 - If you already know the IOR value, you can enter it in the corresponding box. However, if you prefer to let the application calculate the IOR value as a function of the distance between span start and span end, press **Set IOR by Distance**, then enter the distance value.
4. If you want to save the modified IOR, RBS, and helix Factor values for the next acquisitions performed at the current wavelength, select the **Save these settings for next acquisitions** check box.
 5. Press **OK** to apply the changes.
You return to the main window.

Modifying Events

Note: *This function is available in Advanced mode only.*

You can change the loss and reflectance of almost any existing event except:

- continuous fiber
- end of analysis
- launch level
- merged events
- span start
- span end

In the case of a reflective event, you can also specify whether the event corresponds to an echo, a possible echo, or no echo.



IMPORTANT

If you reanalyze a trace, all of the modified events will be lost and the events table will be re-created.

Note: *If you want to modify the attenuation value of a fiber section, see [Changing the Attenuation of Fiber Sections](#) on page 146.*

To modify an event:

1. Select the event you want to modify.
2. Press the **Change Event** button.

Markers **a**, **A**, **B**, and **b** appear on the graph. With these markers, you can define a new location for the selected event.

You can reposition all markers directly by dragging them, or by pressing where you want to relocate them on the graph. Selecting marker **A** or **B** will move the **a-A** or **B-b** pair.

Note: The current marker locations are set, during the analysis, to calculate and display the original event loss and reflectance.

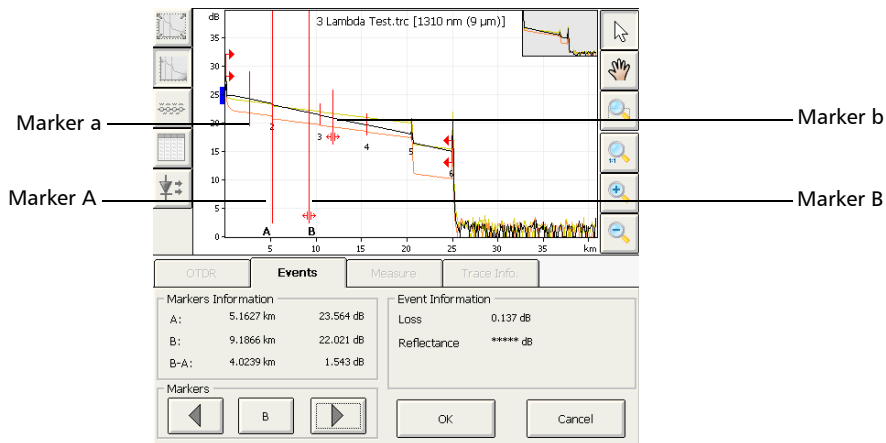

Analyzing Traces and Events

Modifying Events

3. Position marker **A** on the event, and submarker **a** (to the left of marker **A**) as far as possible from marker **A**, without including the preceding event.

The area between markers **A** and **a** must not include any significant variation. For more information on positioning markers, see *Using Markers* on page 165.

4. Position marker **B** after the end of the event, where the trace returns to a regular loss inside the fiber, and submarker **b** (to the right of marker **B**), as far as possible from marker **B**, without including the following event.

The area between markers **B** and **b** must not include any significant variation. For more information on positioning markers, see *Using Markers* on page 165.

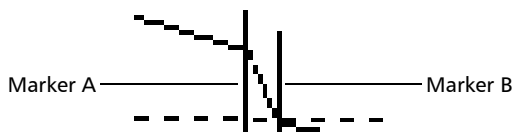

Event loss and reflectance are displayed, respectively, in the **Loss** and **Reflectance** boxes.

OTDR	Events	Measure	Trace Info.
Markers Information		Event Information	
A:	20.5026 km 19.335 dB	Loss	1.498 dB
B:	20.9060 km 16.538 dB	Reflectance	-48.00 dB
B-A:	403.414 m 2.796 dB	Echo status :	<input type="text" value="..."/>
Markers		OK Cancel	

Loss and reflectance values

5. If you selected a reflective event, you can modify the echo status using the up/down arrows of the Echo status list.

Note: Select “- - -” if you want to indicate that the event is not an echo.

6. Press **OK** to accept the modifications you have made or **Cancel** to return to the events table without saving the changes.

The modified events are identified with “*” (appearing beside the event symbol) in the events table as shown below.

OTDR		Events		Measure		Trace Info.	
Type	Number	Loc.	Loss	Refl.	Att.	Cumul.	
→	1	0.0000		-27.4		0.000	▲ Add New Event...
↔		(5.1627 km)	1.598		0.310	1.598	□ Change Event...
↔*	2	5.1627	0.138			1.737	□ Delete
↔		(5.2291 km)	1.748		0.334	3.485	▼
↔	3	10.3917	0.056			3.540	

Analyzing Traces and Events

Inserting Events

Inserting Events

You can insert events in the event table manually.

This could be useful, for example, if you know that there is a splice at a given location, but the analysis does not detect it because it is hidden in the noise or because the splice loss is lower than the minimum detection threshold (see *Setting Pass/Fail Thresholds* on page 53).

You can add this event to the events table manually. This will add a number on the trace at the location of the insertion, but it will *not* modify the trace.



IMPORTANT

Inserted events are removed when you reanalyze a trace.

To insert an event:

1. From the **Events** tab, press **Add New Event**.

OTDR		Events		Measure		Trace Info.	
Type	Number	Loc.	Loss	Refl.	Att.	Cumul.	
→	1	0.0000		-27.4		0.000	Set as Span End
↔	(5.1627 km)		1.598		0.310	1.598	Add New Event...
↘	2	5.1627	0.209			1.808	Change Event...
↔	(5.2291 km)		1.777		0.340	3.584	
↘	3	10.3917	0.052			3.636	

2. Select the location where you want to insert an event.

Markers Information	
A:	5.1780 km 23.383 dB
B:	11.1986 km 21.275 dB
B-A:	6.0206 km 2.107 dB

Event		
Location	Loss	Reflectance
5.1780 km	0.254	---

Four markers are available to measure the inserted event, but only marker **A** identifies where the event will be inserted. Use the marker arrows to move marker **A** on the trace display.

3. Once you have determined the location, under **Event**, use the up/down arrows next to the box to select the desired event type.

Markers Information	
A:	5.1780 km 23.383 dB
B:	11.1986 km 21.275 dB
B-A:	6.0206 km 2.107 dB

Event		
Location	Loss	Reflectance
5.1780 km	0.254	---

4. Press **OK** to insert the event or **Cancel** to return to the events table without making any changes.

Inserted events are marked with asterisks (appearing beside the event number).

Deleting Events

Note: *This function is available in Advanced mode only.*

Almost any event can be deleted from the events table, except:

- end of analysis
- fiber section
- launch level
- end of fiber
- span start
- span end

Note: *The “End-of-fiber” event indicates the span end that was set for the first analysis of the trace, not the span end assigned to another event or distance from the span end in the **Analysis** tab.*



IMPORTANT

The only way to “recover” deleted items is to reanalyze the trace, as you would for a new trace. For more information, see *Analyzing or Reanalyzing a Trace* on page 151.

To delete an event:

1. Select the event you want to delete.

OTDR		Events	Measure	Trace Info.			
Type	Number	Loc.	Loss	Refl.	Att.	Cumul.	
→	1	0.0000		-27.4		0.000	▲
↔	(5.1627 km)		1.598		0.310	1.598	▼
↔	2	5.1627	0.209			1.808	▲
↔	(5.2291 km)		1.777		0.340	3.584	▼
↔	3	10.3917	0.052			3.636	▲

Add New Event...
 Change Event...
Delete

2. Press **Delete**.
3. When the application prompts you, press **Yes** to confirm the deletion, or **No** to keep the event.
4. From the **Edit Comments** dialog box, enter a comment.

To delete a comment:

1. Select the event on which you want to delete a comment.
2. From the **Events** tab, press **Edit Comments**.
3. From the **Edit Comments** dialog box, delete the text.
4. Press **OK**.

Changing the Attenuation of Fiber Sections

Note: This function is available in Advanced mode only.

You can change the attenuation value of fiber sections.



IMPORTANT

If you reanalyze a trace, all of the modifications made to the fiber sections will be lost and the events table will be re-created.

Note: If you want to modify events, see *Modifying Events* on page 138.

To modify the attenuation of a fiber section:

1. From the event table, select the fiber section.
2. Press the **Change Event** button.

The **A** and **B** markers appear in the trace display.

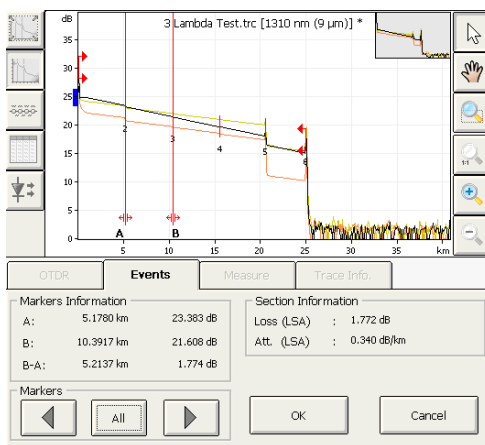

3. Position markers as desired to modify the attenuation value. For more information on positioning markers, see *Using Markers* on page 165.

Note: *The markers serve only to set the new attenuation value. Their actual locations will not be modified.*

Fiber section loss and attenuation are displayed respectively in the **Loss (LSA)** and **Att. (LSA)** boxes.

Markers Information	
A:	5.1780 km 23.383 dB
B:	10.3917 km 21.608 dB
B-A:	5.2137 km 1.774 dB

Section Information	
Loss (LSA)	: 1.772 dB
Att. (LSA)	: 0.340 dB/km

Loss and attenuation values

4. Press **OK** to accept the modifications you have made or **Cancel** to return to the events table without saving the changes.

The modified fiber sections are identified with “*” in the events table as shown below.

Type	Number	Loc.	Loss	Refl.	Att.	Cumul.
→	1	0.0000		-27.4		0.000
→		(5.1627 km)	1.598		0.310	1.598
→	2	5.1627	0.209			1.808
→		(5.2291 km)	1.817		0.348	3.625
→	3	10.3917	0.052			3.677

Setting the Analysis Detection Thresholds

Note: *This function is available in Advanced mode only.*

To optimize event detection, you can set the following analysis detection thresholds:

- *Splice loss threshold:* To display or hide small non-reflective events.
- *Reflectance threshold:* To hide false reflective events generated by noise, transform non-harmful reflective events into loss events, or detect reflective events that could be harmful to network and other fiber-optic equipment.
- *End-of-fiber threshold:* To stop the analysis as soon as an important event loss occurs; for example, an event that could compromise signal transmission toward the end of a network.



IMPORTANT

The end-of-fiber (EoF) threshold that you define will be used in Automatic mode and in Advanced mode if you let the application evaluate the acquisition settings.

If you set this threshold, an EoF event will be inserted at the first event for which the loss crosses the threshold. The application will then use this EoF event to determine the acquisition settings.

The following examples show how different splice-loss threshold levels can affect the number of displayed events, especially small non-reflective events such as those caused by two splices. Three traces are shown, corresponding to three threshold level settings.

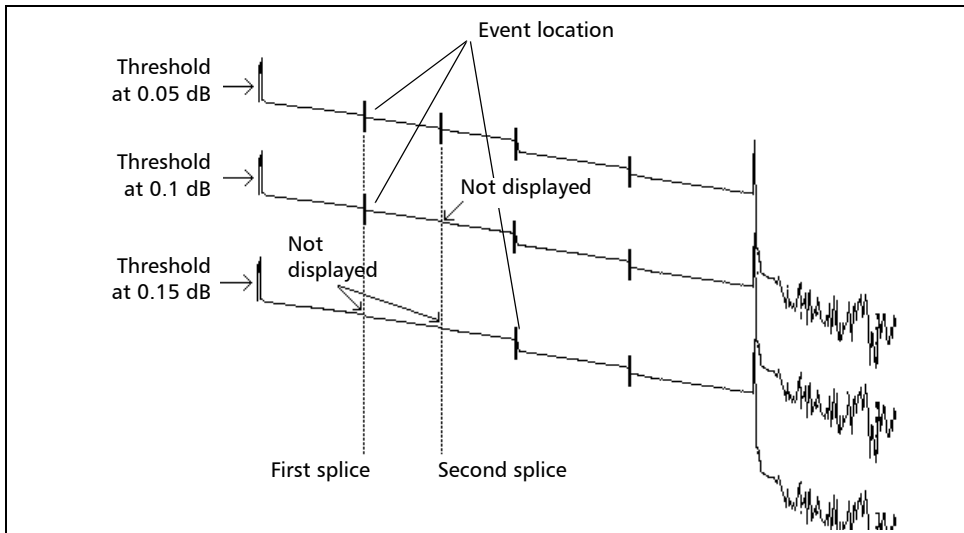

➤ *Threshold at 0.05 dB*

With the threshold set to 0.05 dB, two events are displayed at distances corresponding to the location of the first and second splices.

➤ *Threshold at 0.1 dB*

Only the first splice is displayed, as the threshold is set to 0.1 dB and the second splice loss is lower than 0.1 dB.

➤ *Threshold at 0.15 dB*

The first two splices are not displayed, as the threshold is set to 0.15 dB and the first and second splice losses are lower than 0.15 dB.

Analyzing Traces and Events

Setting the Analysis Detection Thresholds

To set the analysis detection thresholds:

1. From the button bar, press **OTDR Setup**.
2. From the **OTDR Setup** dialog box, select the **Analysis** tab.
3. Under **Analysis parameters**, set the parameters.

The screenshot shows the 'Analysis' tab of the OTDR Setup dialog box. The 'Analysis parameters' section is highlighted with a red border. It contains the following settings:

- Automatically analyze data after acquisition
- Splice loss detection threshold: 0.020 dB
- Reflectance detection threshold: -72.0 dB
- End-of-fiber detection threshold: 5.000 dB
- Default button

Below the 'Analysis parameters' section, there are two sections: 'Span start' and 'Span end'. Each section has a radio button for 'Set on event' (selected) and 'Set by distance', and an 'Event number' spinner set to 1. An 'Exit OTDR Setup' button is located on the right side of the dialog box.

- Enter the desired values in the appropriate boxes.

OR

- Select the default settings by pressing **Default**.

4. Press **Exit OTDR Setup**.

The analysis detection thresholds you have just set are applied to all newly acquired traces.

Note: *Analysis thresholds are only saved in the trace during analysis. For traces acquired, but not yet analyzed, you can change the analysis detection thresholds in the OTDR test application before performing the analysis.*

Analyzing or Reanalyzing a Trace

Note: *This function is available in Advanced mode only.*

You can analyze a displayed trace at any time. Analyzing or reanalyzing a trace will:

- produce an events table for a trace, if there was none (for example, the *Automatically Analyze Data after Acquisition* feature was not selected; see *Enabling or Disabling Analysis After Acquisition* on page 51).
- reanalyze a trace acquired with a previous version of the software.
- re-create the events table if it was modified.
- perform a Pass/Fail test, if enabled (for more information, see *Setting Pass/Fail Thresholds* on page 53).

When you reanalyze a trace acquired in Template mode:

- Events copied from the reference trace (identified by “*”) will be lost.
- The application will assign a number to the events that were identified by question marks.

If you prefer to focus your analysis on a specific fiber span, see *Analyzing the Fiber on a Specific Fiber Span* on page 153.

Analyzing Traces and Events

Analyzing or Reanalyzing a Trace

To analyze or reanalyze a trace:

1. From the main window, go to the **Events** tab.
2. Press the **Analyze** button.
3. From the **Reanalyze Trace** dialog box, select an item for setting the span start and end markers on the trace. On the first analysis, this dialog box is not displayed and the default span start and end are applied (See *Setting a Default Span Start and Span End* on page 58).

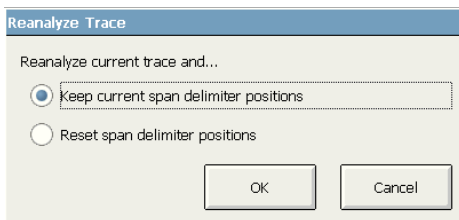

- **Keep current span delimiter positions** applies the current fiber span upon trace reanalysis.
 - **Reset span delimiters positions** applies the fiber span defined in the **OTDR Setup** upon trace reanalysis.
4. Press **OK** to confirm.

Analyzing the Fiber on a Specific Fiber Span

Note: *This function is available in Advanced mode only.*

If you want to focus your fiber analysis on a specific fiber span, you can define events (new or existing) as a span start and/or span end. You can even define a fiber span for short fibers by placing the span start and the span end on the same event.

Note: *You can set a default span start and end, which will be applied during the first analysis or reanalysis performed upon trace acquisition.*

To set a fiber span:

- 1.** From the main window, go to the **Events** tab.
- 2.** Define the span event location by moving marker **A** along the trace using the selection dial.
- 3.** Press **Set as Span Start** or **Set as Span End** to set the span start or span end marker on the appropriate event in the trace display.

Changes to the span start and span end will modify the contents of the events table. The span start becomes event 1 and its distance reference becomes 0. Events excluded from the fiber span are grayed out in the events table, and do not appear in the trace display. The cumulative loss is calculated within the defined fiber span only.

Enabling or Disabling the Detection of Reflective Ends of Fiber

By default, the application stops the analysis as soon as there is too much noise on a trace to ensure accurate measurements. However, you can configure the application to search the “noisy” portion of the trace to detect strong reflective events (such as those caused by UPC connectors) and set the span end at this point.

If your OTDR model is FTB-7000D or later, you can configure the application to detect reflective ends of fiber.

Note: *The detection of reflective ends of fiber is only performed when you test at singlemode wavelengths.*

Once you have selected the option, the detection will be performed automatically on the next acquisitions.







If a trace was acquired without selecting the option first, you will have to reanalyze the trace manually (for more information on trace reanalysis, see *Analyzing or Reanalyzing a Trace* on page 151). When you reanalyze a trace, to benefit from the option, you should select *Reset span delimiter positions*.

The application will take into account the option only if there is a significant reflective event located after the end of analysis.

Analyzing Traces and Events

Enabling or Disabling the Detection of Reflective Ends of Fiber

The table below shows the differences you will notice in the event table depending on if you enable the detection of reflective ends of fiber or not.

Option not selected (conventional analysis)			Option selected	
Case	Event on which span end is set	Loss or reflectance value	Event on which span end is set	Loss or reflectance value
Span end located on a physical event that crosses the end-of-fiber (EoF) threshold	Non-reflective fault  or reflective fault 	Value as calculated by the conventional analysis	Same as the conventional analysis	Same as the conventional analysis
Span end located on a physical event whose loss is below the EoF threshold	Non-reflective fault  or reflective fault 	Value as calculated by the conventional analysis	If applicable, reflective fault  (located in the “noisy” area) ^a	If applicable, reflectance value as calculated by the conventional analysis. ^b
Span end not located on any physical event	End of analysis 	N/A	If applicable, reflective fault  (located in the “noisy” area) ^{c,d}	If applicable, reflectance value as calculated by the conventional analysis. ^b

- The cumulative loss value will remain the same for all elements appearing after the event on which the span end was set according to the conventional analysis. The span loss value (**Trace Info.** tab) will correspond to the loss calculated between span start and the event on which the span end was set according to the conventional analysis.
- Value is underestimated because the event is located in the “noisy” area.
- The end-of-analysis event is replaced by a non-reflective event  with a loss value of 0 dB.
- The cumulative loss value will remain the same for all elements appearing after the inserted event. The span loss value (**Trace Info.** tab) will correspond to the loss calculated between span start and the inserted event.

Analyzing Traces and Events

Enabling or Disabling the Detection of Reflective Ends of Fiber



IMPORTANT

The analysis will stop as soon as the loss of an event crosses the end-of-fiber (EoF) threshold. The application will mark the event as an end-of-fiber event.

In this case, even if you selected the option, the application *will not* search the “noisy” portion of the trace for reflective ends of fiber. If you want to do so, you will have to increase the EoF threshold (see *Setting the Analysis Detection Thresholds* on page 148).

To enable or disable the detection of reflective ends of fiber:

- 1.** From the button bar, press **OTDR Setup**.
- 2.** From the **OTDR Setup** dialog box, go to the **Event Table** tab.

3. If you want to enable the option, under **End-of-Fiber parameters**, select the **Reflective end-of-fiber detection** box.

OR

If you prefer to disable the option, clear the box.

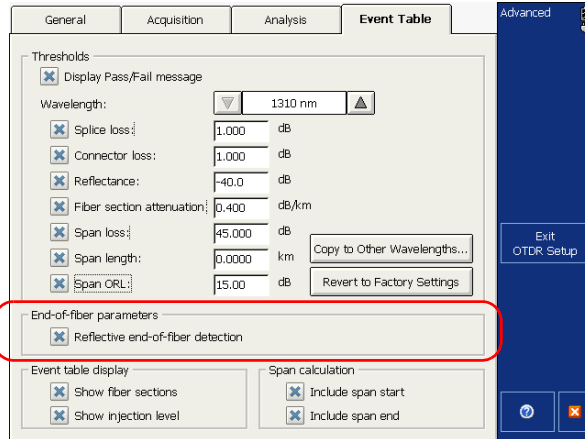

4. Press **Exit OTDR Setup**.

Swapping Traces

Note: This function is available in Advanced mode only.

Since the events table and the trace information are based on the main trace, you may want to interchange main and reference traces.

When you swap traces, the application will provide a new set of events corresponding to the new main trace.

To swap traces:

1. From the button bar, press **Storage**.
2. From the **Storage** dialog box, select **Swap Main/Reference**.

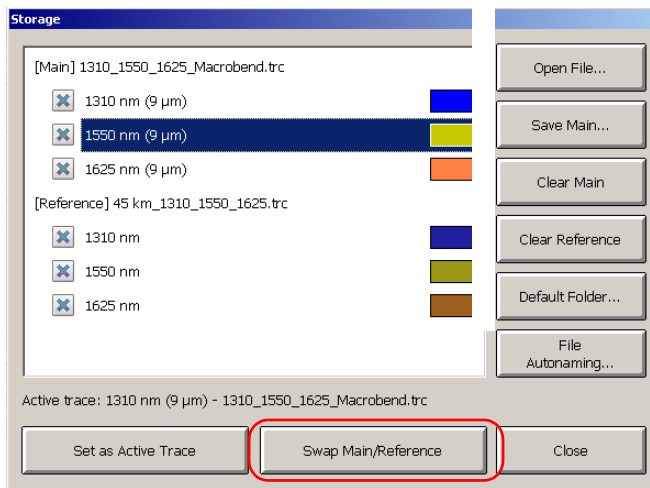

Note: You can change a main trace into a reference trace, and vice versa, even if only one trace is in the application's memory.

Opening Trace Files

In Advanced mode, you can open a trace file as the main trace or the reference trace.

You can open both the main and reference trace files at the same time. You can open two multiple wavelength trace files simultaneously, each containing several traces.

In Automatic mode, you can open a trace file *for viewing only*. Consequently, you cannot select a trace as main or reference trace.

Note: *You cannot open bidirectional trace files in the OTDR test application. Use the OTDR Bidirectional application instead (see Analyzing Traces with the Bidirectional Analysis Application on page 193).*

When you open trace files, the application always displays the first wavelength of the file.

Analyzing Traces and Events

Opening Trace Files

The table below presents the possible behavior of the zoom and markers when you open traces (main or reference). If you open old OTDR traces, see the corresponding row for more information.

Type of file	Zoom	Marker
Trace that has been saved with an automatic zoom on the selected event ( button was pressed)	Application automatically zooms in on the event that was selected on the first trace (wavelength) of the file. If you switch to the next trace, the application will automatically zoom in on the event that was selected for the second trace.	Markers that are displayed correspond to those of the selected event.
Trace that has been saved with a manual zoom; no reference file is open.	Application zooms in on the first trace (wavelength) of the file, according to the zoom area and zoom factor that were saved with the file. Application does not zoom in on the selected events. The same zoom will be applied to all traces.	Markers are displayed in the same state they were when you saved the file. Markers will remain at the same location even if you switch to another trace.
Old trace file	Traces are displayed in full view mode. The first event of the trace is selected.	Application defines default positions for markers.

If you want to keep the current zoom and markers, you must save your file before opening another one.

As soon as a reference trace is open, the application will apply the zoom and marker settings of the reference file to all traces (main and reference).

For detailed information on compatibility between EXFO's file formats and software versions, see *OTDR Trace File Compatibility* on page 178.

For information on the various criteria that are applied when loading traces in Template mode, see *Restrictions of Template Mode* on page 62.

For information on how to navigate between traces, see *Displaying or Hiding a Trace* on page 130.

Analyzing Traces and Events

Opening Trace Files

To open a trace file:

1. From the button bar, press **Storage**, then **Open File**.

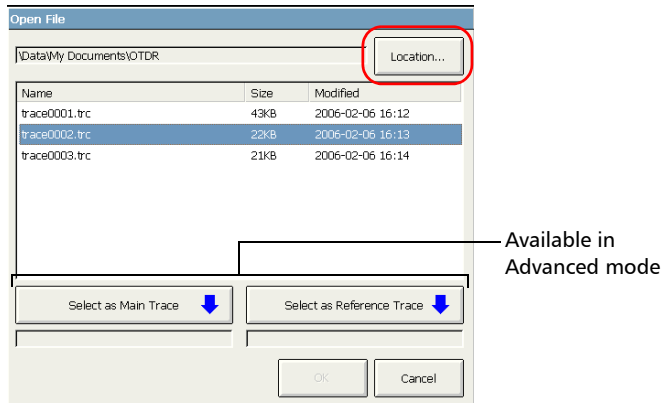

2. If necessary, change the location to retrieve the file that was stored.
3. Scroll through the list of files and select a trace file to open.
4. If you are in Advanced mode, press the **Select as Main Trace** or **Select as Reference Trace** button to indicate whether the selected trace will be used as the main or the reference trace.

You can select another file from the list and set the trace as the main or reference trace, according to your needs.

5. Press **OK**.

You return to the **Storage** dialog box.

If you had already acquired (but not stored) a trace, the application prompts you to save the current trace (even if the trace is hidden). Press **Yes** to store the trace. You can now open another trace file.

6. If necessary, specify which traces should be displayed. For more information, see *Displaying or Hiding a Trace* on page 130.
7. Press **Close**.

11 Analyzing the Results Manually

Once a trace has been acquired or opened, you can use markers and zoom in on or out of any event or trace segment to measure splice loss, fiber section attenuation, reflectance, and optical return loss.

Selecting the Attenuation and Loss Values that Will Be Displayed

By default, in the **Measure** tab, the application only displays the values obtained by using the same measurement methods as the analysis, that is the four-point event loss and the A-B LSA attenuation.

Note: *This function is not available in Auto mode because you do not have access to the **Measure** tab in this mode.*

You can display the values corresponding to the following measurement methods:

- For loss:
 - Four-point event loss
 - A-B LSA (Least-Square Approximation) loss
- For attenuation:
 - Two-point section attenuation
 - A-B LSA (Least-Square Approximation) attenuation

Note: *You must select at least one measurement method for loss value and one measurement method for attenuation value.*

Analyzing the Results Manually

Selecting the Attenuation and Loss Values that Will Be Displayed

To select the attenuation and loss values that will be displayed:

1. From the button bar, press **OTDR Setup** then go to the **General** tab.
2. Press the **Measurement Method** button.
3. Select which values you want to see in the **Measure** tab.

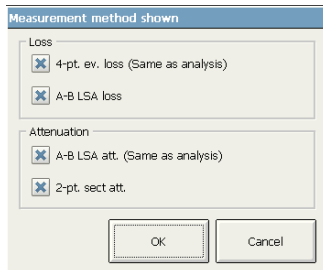



4. Press **OK** to confirm your selection.
5. Press **Exit OTDR Setup** to return to the OTDR application.

Using Markers

You can use markers to view the position and relative power of an event.

Markers are available from the **Events** tab (when you modify or add an event) or the **Measure** tab in the main window.

To move a marker:

1. Ensure that the  button is selected in the zoom button bar.
2. From the **Measure** tab, press the markers button until it displays the desired marker. You can also use  from the keypad.

In addition to the **a**, **A**, **B**, and **b** markers, you can also select the **All** item.

3. Once the appropriate marker is selected, use the right and left arrow buttons to move the marker along the trace. You can also move it with the selection dial located on the front of the unit.

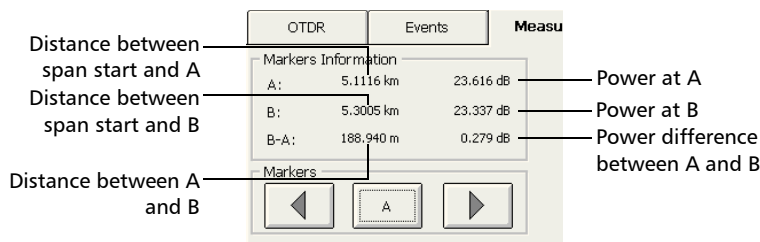

Note: You can also select the marker directly on the trace display and drag it to the desired position.

If a marker is moved closed to another one, both will move together. This ensures a minimum distance is maintained between markers.

A marker may disappear from the trace after you zoom in (see *Using Zoom Controls* on page 123). You can recall it by selecting a missing marker with the **Markers** button or by using one of the arrows to bring the selected marker back into the displayed area.

Analyzing the Results Manually

Getting Event Distances and Relative Powers

Getting Event Distances and Relative Powers

The OTDR test application automatically calculates the position of an event and displays this distance in the events table.

You can retrieve the position of an event as well as the distance between events manually. You can also display various relative power readings.

Distances and relative powers correspond to the X-axis and Y-axis, respectively.

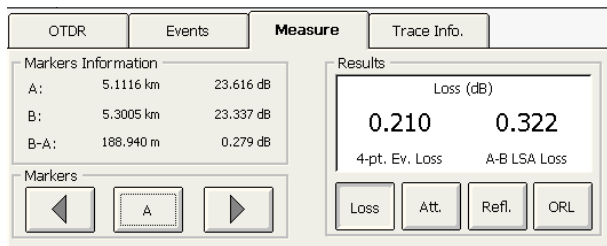

To get the distance to an event and the associated relative power level:

1. From the main window, select the **Measure** tab.
2. Move marker **A** to the beginning of the event. For more information about markers, see *Using Markers* on page 165.

Getting Event Loss (Four-Point and Least-Square Approximation)

Event loss (expressed in dB) is calculated by measuring the signal level reduction in Rayleigh backscatter (RBS) caused by this event. Event loss can result from both reflective and non-reflective events.

Two loss calculations are provided simultaneously: the four-point event loss and the A-B LSA loss. Both calculations use the least-square approximation (LSA) method to determine the event loss. *However, the four-point event loss is the preferred method and the one that corresponds to the loss displayed in the events table.*

Analyzing the Results Manually

Getting Event Loss (Four-Point and Least-Square Approximation)

- *Four-point event loss*: the LSA method is used to fit a straight line to the backscatter data within the two regions defined by markers a, A and b, B, that is over the regions to the left and to the right of the event bordered by markers A and B, respectively.

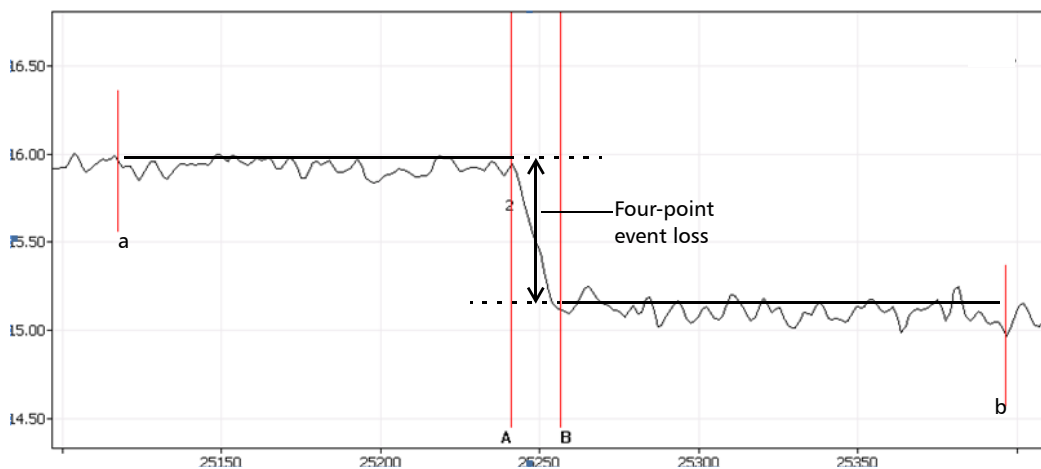

The two fitted lines are then extrapolated toward the center of the event and the loss event is directly read from the drop in power between the two lines.

Analyzing the Results Manually

Getting Event Loss (Four-Point and Least-Square Approximation)

- *A-B LSA loss*: the loss of the event bordered by the markers A and B is obtained by fitting a straight line to the backscatter data between these two markers.

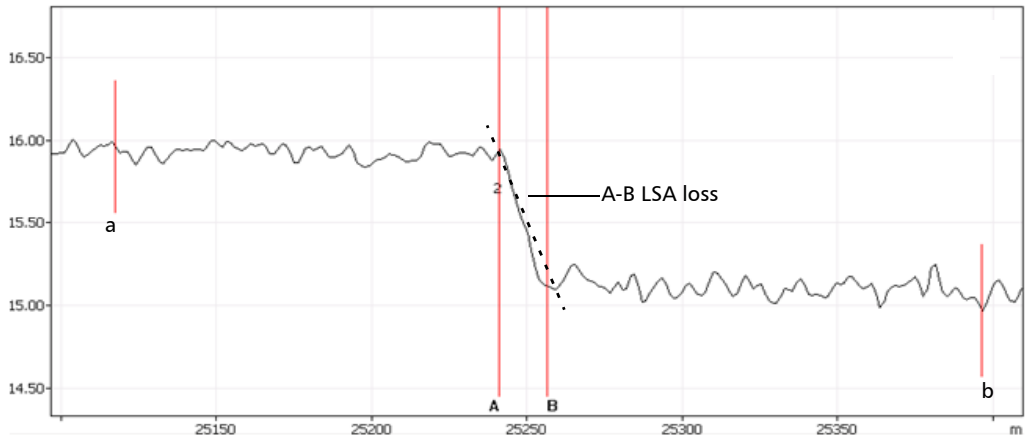

The event is then obtained by the reduction in power (dB) over the distance between the two markers, as calculated from the slope of the fitted line.

Although this method works fairly well for splice loss, it is clearly not appropriate for reflective events (definitely not a “straight-line” event). A-B LSA Loss is mainly used to rapidly compute loss over a given length of a fiber section.

Note: *A-B LSA event loss measurements should be used on fiber sections only. Measuring events will not yield meaningful results.*

Analyzing the Results Manually

Getting Event Loss (Four-Point and Least-Square Approximation)

To get event loss:

- 1.** From the main window, select the **Measure** tab.
- 2.** In the **Results** section, press **Loss**. Markers **a**, **A**, **B** and **b** appear on the graph.
- 3.** Zoom in and position marker **A** at the *end* of the linear area *preceding* the event to be measured. For more information, see *Using Zoom Controls* on page 123 and *Using Markers* on page 165.
- 4.** Position submarker **a** at the *beginning* of the linear area *preceding* the event to be measured (must not include any significant events).

Analyzing the Results Manually

Getting Event Loss (Four-Point and Least-Square Approximation)

5. Position marker **B** at the *beginning* of the linear area *following* the event to be measured.
6. Position submarker **b** at the *end* of the linear area *following* the event to be measured (must not include any significant events).

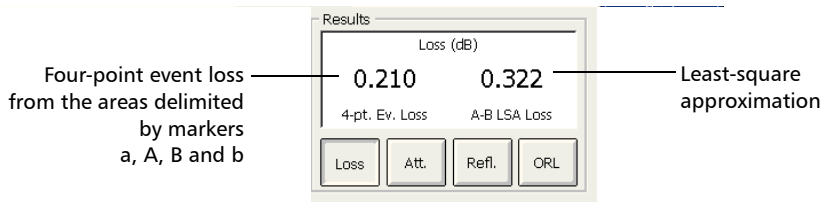
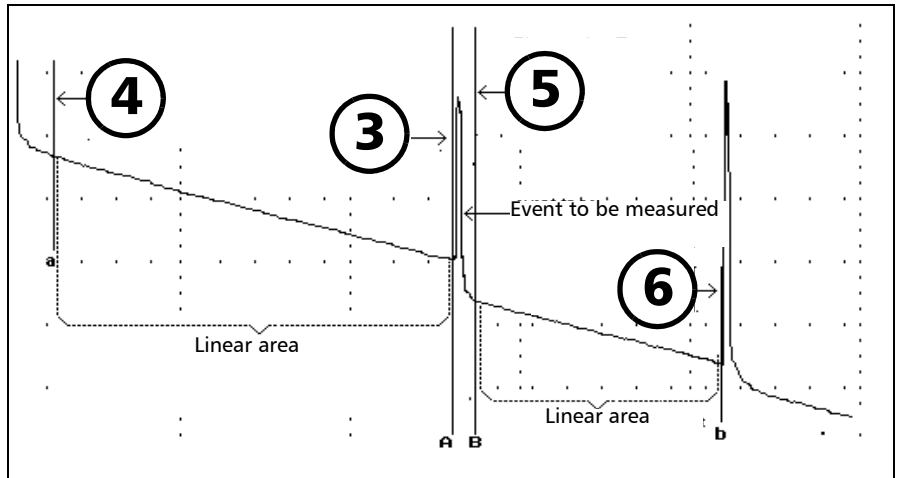

Note: The loss values that are displayed depend on which calculation methods are selected (see *Selecting the Attenuation and Loss Values that Will Be Displayed* on page 163).

Getting Attenuation (Two-Point and Least-Square Approximation)

A two-point attenuation measurement gives the reduction in Rayleigh backscatter level as a function of distance (always expressed in dB/km to follow the standards of the fiber-optic industry) between two selected points. Only those two points are used to perform the calculation and there is no averaging.

The least-square approximation (LSA) method measures the attenuation (loss over distance) between two points by fitting a straight line in the backscatter data between markers **A** and **B**. The LSA attenuation corresponds to the difference in power (Δ dB) over the distance between two points.

The LSA method, when compared to the two-point method, gives an average measurement and is more reliable when there is a high level of noise. However, it should not be used if an event such as an echo appears between the two markers.

Analyzing the Results Manually

Getting Attenuation (Two-Point and Least-Square Approximation)

To get attenuation:

1. From the main window, select the **Measure** tab.
2. In the **Results** section, press the **Att.** button. Markers **A** and **B** appear on the graph.
3. Place markers **A** and **B** at any two points on the trace. For more information, see *Using Markers* on page 165.
4. Zoom in on the trace and fine-tune the marker positioning if necessary. For more information, see *Using Zoom Controls* on page 123.

Note: *There should not be any events between markers A and B when performing the two-point attenuation measurement.*

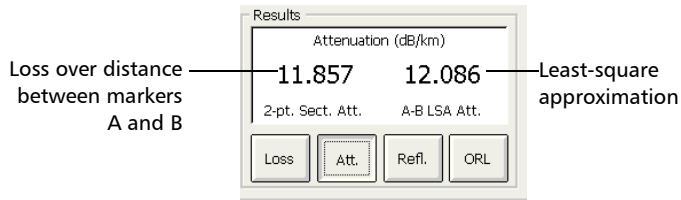

Note: *The attenuation values that are displayed depend on which measurement methods are selected (see *Selecting the Attenuation and Loss Values that Will Be Displayed* on page 163).*

Getting Reflectance

Reflectance is the ratio of reflected light to input light.

Note: *If you are testing in Real time, the reflectance value you will get is not necessarily accurate.*

To get reflectance:

1. From the main window, select the **Measure** tab.
2. In the **Results** section, press the **Refl.** button. Markers **a**, **A** and **B** appear on the graph.
3. Zoom in and position marker **A** on the linear area *preceding* the event to be measured. For more information, see *Using Zoom Controls* on page 123 and *Using Markers* on page 165.
4. Position submarker **a** at the beginning of the linear area *preceding* the event to be measured.
5. Position marker **B** at the *peak* of the reflective event to be measured.

Note: *Using this procedure, you can measure the reflectance of all the events in a merged reflective fault event.*

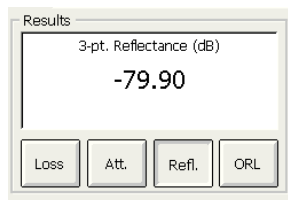

Note: *For non-reflective events, ***** will be displayed.*

Getting Optical Return Loss (ORL)

Note: You must use a singlemode OTDR for ORL calculations.

The ORL calculation will provide the following information:

- the ORL between markers **A** and **B**
- the total ORL is calculated either between the span start and the span end, or on the total fiber span, depending on the option you have selected in the **Setup** window.

Optical return loss (ORL) refers to the total effect of multiple reflections and scattering events within a fiber-optic system.

Note: If you are testing in Real time, the reflectance value you will get is not necessarily accurate.

To get the ORL value:

1. From the main window, select the **Measure** tab.
2. In the **Results** section, press **ORL**. Markers A and B appear on the graph.

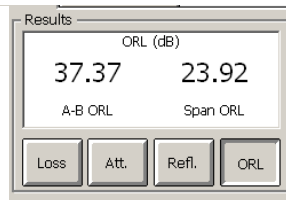

3. Position markers A and B to delimit the area for which you want to know the ORL value.

12 **Managing Trace Files from the OTDR Test Application**

Once you have acquired traces, or when you want to work with them after an acquisition, you will need to save, open, rename, and delete trace files.

You can save and open trace files from the OTDR test application. To rename, copy, move, and delete trace files, you must use the **File Manager** utility.

Saving a Trace in a Different Format

With the OTDR application, you can save traces in native (.trc) and Bellcore (.sor) formats. By default, the application saves the traces in native (.trc) format. For information on how to define the default file format, see *Selecting the Default File Format* on page 93).

To save an OTDR trace file in another format:

Use the OTDR Viewer application (available on the CD that came with your product) installed on a computer.

OTDR Trace File Compatibility

The table presented hereafter shows the compatibility between the format of a specific trace and the software that you may use to open that trace.

Symbols used in the table	Meaning
X	Fully compatible
Conv	Conversion or reanalysis necessary
---	Not compatible

Managing Trace Files from the OTDR Test Application

OTDR Trace File Compatibility

Software used to open the file...								
		ToolBox 5.5	ToolBox 6.5 or earlier	ToolBox 6.7 to 6.20	ToolBox 6.21 or later	FTB-100 2.5 or earlier	FTB-100 2.6 or 2.7	FTB-100 2.8 or later/ FTB-150 FTB-200 AXS-100
File generated with...	ToolBox 5.5	X	X	X	X	Conv ^a	Conv ^a	Conv ^a
	ToolBox 6.5 or earlier	Conv ^b	X	X	X	Conv ^a	Conv ^a	Conv ^a
	ToolBox 6.7 to 6.20	Conv ^c	Conv ^c	X	X	Conv ^{a,d}	Conv ^a	Conv ^a
	ToolBox 6.21 or later	Conv ^c	Conv ^c	Conv ^{f,e}	X	Conv ^{a,d}	Conv ^a	X
	FTB-100 2.2 or earlier	X	X	X	X	X	X	X
	FTB-100 2.5	---	X	X	X	X	X	X
	FTB-100 2.6 or 2.7	---	---	X	X	X	X	X
	FTB-100 2.8 or later/ FTB-150 FTB-200 AXS-100 FTB-200 v2 Compact Modular Platform	---	---	Conv ^{e,f}	X	Conv ^{a,d,f}	Conv ^{a,d,f}	X

- Should be saved in or converted to FTB-100 (.ftb100) format.
- Should be reanalyzed to view the events table.
- Data should be saved in FTB-300 (.ftb300) format and reanalyzed to view the events table.
- Triple-wavelength trace files are not compatible.

Managing Trace Files from the OTDR Test Application

Copying, Moving, Renaming, or Deleting Trace Files

- e. Should be converted to ToolBox 6.7-6.20 format.
- f. Should be converted with ToolBox 6.21 or later.

Copying, Moving, Renaming, or Deleting Trace Files

If you want to copy, move, rename or delete trace files, you will have to process the files manually via **File Manager** available from Compact ToolBox. For more information, refer to your unit help.

13 **Creating Reports**

For future reference, you can add notes on the location of the tested fiber, type of job performed and general comments related to a trace in trace reports.

Adding Information to the Test Results

After acquiring a trace, you might want to include or update information about the tested fiber and job or add comments. The information you enter is saved only for the currently open trace file.

After entering the required data, you may save the contents as a template. The next time you access the report to add information to a newly acquired trace, the template is automatically recalled, eliminating repetitive documentation operations.

Note: *The information must be entered before acquiring traces in Template mode. For more information, see Testing Fibers in Template Mode on page 61.*

Some of the information is common to all wavelengths (location A and B, cable ID and fiber ID). Some other is specific to the current wavelength (job ID, operators A and B, company, customer and comments). If you clear information from the **Report** window, both the common and the specific information will be deleted. The information specific to other wavelengths will not be deleted (you must delete it manually).

Creating Reports

Adding Information to the Test Results

To add information to the test results:

1. From the button bar, once a trace has been acquired or reopened, press **Report**.
2. Enter the desired information.

The screenshot shows a software dialog box titled "Advanced" with a close button in the top right corner. The dialog is organized into several sections:

- Fiber:** Contains text boxes for "Fiber ID:" (Fiber 0013), "Cable ID:" (Cable 1), "Location A:" (Location A), and "Location B:" (Location B). Below these is a "Direction:" section with two radio buttons: "A->B" (selected) and "B->A".
- Measurement:** Contains text boxes for "Date:" (2006-10-26), "Time:" (10:32 (GMT-5:00)), "Unit:" (Your unit), and "Serial no.:" (388567).
- Job:** Contains text boxes for "Job ID:" (Job 1), "Operator A:" (Operator A), "Operator B:" (Operator B), "Company:" (My company), and "Customer:" (My customer).
- Comments:** A large text area containing the text "For maintenance purpose." with a vertical scrollbar on the right.

At the bottom of the dialog are two buttons: "Use Default Trace Information" and "Clear All". To the right of the dialog is a dark blue sidebar with an "Exit Identification" button and two small icons at the bottom (a refresh icon and a close icon).

Note: The information in the **Date**, **Time**, **Unit** and **Serial no.** boxes is provided by the application and cannot be edited. You can edit the **Fiber ID** only if the **Use autonaming** feature is not selected.

Note: If you select the **Use autonaming** box, the **Fiber ID** box becomes unavailable.

If you want to save the contents as a template, use the **Save as Template** button.

3. Press **Exit Report** to return to the trace display.

The information entered is saved with the trace and can be viewed or changed at any time using the same process.

To clear all the information from the Report window:

Press the **Clear All** button.

Note: *The information appearing in the **Date**, **Time**, **Unit**, and **Serial no.** boxes cannot be deleted. The **Fiber ID** can only be deleted if the **Use autonaming** feature is not selected.*

Generating a Report

You can print trace reports directly from your unit. By default, only the information related to the active trace is printed in a report, but you can also print all the traces the current file contains (available in Advanced and Auto modes only). In Template mode, only the current trace will be printed. The following table shows the various items that can appear on a report, depending on the test mode (Auto, Advanced or Template) that is selected.

Item appearing on the report	Auto mode	Advanced mode	Template mode
Summary table: a single table containing the pass/fail status, the span loss and span ORL for all the wavelengths. By default, this item is selected.	X	X	

Creating Reports

Generating a Report

Item appearing on the report	Auto mode	Advanced mode	Template mode
<p>Macrobend table: a single table containing the location and the delta loss of all the detected macrobends. This table is followed by another table which contains the macrobend thresholds.</p> <p>Note: <i>This table is global to the fiber and will be printed if the application has detected macrobends (at any wavelength). For example, even if you choose to only print the current trace (for which no macrobends have been detected at this particular wavelength), the table could be printed if macrobends have been detected at other wavelengths.</i></p> <p>By default, this item is selected if you purchased this option. Otherwise, the item will be unavailable or hidden if you configured the application as such (see <i>Displaying or Hiding the Optional Features</i> on page 103).</p>	X	X	
<p>Cable information: a single table containing information such as the fiber ID, cable ID, location A and B.</p> <p>By default, this item is selected.</p>	X	X	X
<p>Job information: test date and time (including the time zone), unit serial and model numbers, job and customer ID.</p> <p>By default, this item is selected.</p>	X	X	X

Item appearing on the report	Auto mode	Advanced mode	Template mode
<p>Test and Cable Setup for main and reference traces: file name, OTDR model, software version, wavelength, distance, IOR, RBS, acquisition time, pulse width, and helix factor.</p> <p>In Template mode, only the information of the current trace will be printed.</p> <p>By default, this item is selected.</p>	X	X	X
<p>Comments</p> <p>By default, this item is selected.</p>	X	X	X
<p>Link measurement: link length and loss, Average loss, Average splice loss, and Span ORL.</p> <p>By default, this item is selected.</p>	X	X	X
<p>Markers: marker information: a, A, b, B, and A to B distances, as well as A to B attenuation, loss, and ORL.</p> <p>By default, this item is selected.</p>		X	X
<p>Event table: If you selected the <i>Mark faults in event table</i> feature from the OTDR setup, the failed results will appear in white on a black. Otherwise, they will not be “highlighted”.</p> <p>By default, this item is selected.</p>	X	X	X
<p>Event info</p> <p>By default, this item is selected.</p>	X	X	X

Creating Reports

Generating a Report

Item appearing on the report	Auto mode	Advanced mode	Template mode
<p>Pass/Fail thresholds: loss, reflectance, fiber section attenuation thresholds as they are defined in OTDR setup, under Event table.</p> <p>Note: <i>Selecting this item will not highlight the failed results in the report. You must select the Mark faults in event table feature from the OTDR setup and include the Event table item in your report.</i></p> <p>By default, this item is selected if you selected the <i>Mark faults in event table</i> feature from the OTDR setup. Otherwise, the item will be unavailable.</p>	X	X	X
<p>Graph: You can select the Zoom item if you want the traces to be printed with the zoom factor you selected:</p> <ul style="list-style-type: none"> ➤ Manual zoom: Graphs will be printed exactly as they appear on screen. The same zoom factor will be applied to all traces (wavelengths) of a particular file. ➤ Zoom on selected event: Graphs will be printed with zoom on the area corresponding to the selected event (one event per trace, that is, one per wavelength). <p>By default, this item is selected.</p>	X	X	X

The application will keep in memory the items you have included in your reports for future use.

To print reports:

1. From the **Print** dialog box, select the report characteristics, including whether you want to include the graphs or not.

Select the **Print all traces** item to print all traces (wavelengths) from the current file (available in Auto and Advanced modes only).

2. Press **Print** to start the process.

You will automatically return to the main window.

14 Using the OTDR as a Light Source or VFL

- If you want to perform measurements with a power meter and your OTDR as a source, the OTDR port can transmit a special tone. This port can be used only to transmit—not detect that tone.
- The Visual Fault Locator (VFL) application is used to set the OTDR to send a red signal along the fiber, which can be used for visual fault location and fiber identification.

Note: *The VFL option will be available only if your OTDR is equipped with a VFL port.*



CAUTION

Never connect a live fiber to the OTDR port without a proper setup. Any incoming optical power ranging from -65 dBm to -40 dBm will affect the OTDR acquisition. The way the acquisition will be affected depends on the selected pulse width. Any incoming signal greater than -20 dBm could damage your OTDR permanently. For live-fiber testing, refer to the SM Live port specifications for the characteristics of the built-in filter.

Using the OTDR as a Light Source or VFL

To use your OTDR as a source:

1. Clean the connectors properly (see *Cleaning and Connecting Optical Fibers* on page 22).
2. Connect one end of the fiber under test to the OTDR port.

If your unit is equipped with two OTDR ports, ensure that you connect the fiber to the appropriate port (singlemode, singlemode live, or multimode), depending on the wavelength you intend to use.

3. From the main window, press the  button.
4. Select the wavelength you want to use.

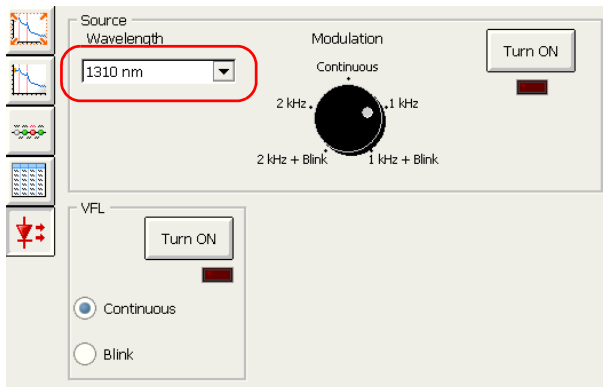

Note: If only one wavelength is available, it is selected by default.

5. Select the desired modulation.

Under **Modulation**,

- For loss measurement, with a power meter at the other end, select **Continuous**.



IMPORTANT

Measurements using the **Continuous** setting must always be taken using a GeX detector.

An OTDR source is very powerful and it will certainly saturate Ge and InGaAs detectors, which usually saturate at 6 dBm, while GeX detectors saturates at 26 dBm.

- For fiber identification, select **1 kHz** or **2 kHz**. This will allow the person at the other end of the link to identify the fiber under test, which could be particularly useful when working with cables containing many fibers.

For easier fiber identification, the application also offers a flashing pattern. If you select this pattern, the modulated signal (1 KHz or 2 KHz) will be sent for 1 second, then will be off for the next second, then be sent again for 1 second, and so on. If you want the OTDR to emit light in a flashing pattern, select **1 kHz+Blink** or **2 kHz+Blink**.

6. Under **Source**, press **Turn ON**. You can stop light emission at any time by pressing **Turn OFF**.

Using an EXFO power meter with tone-detection features, such as the FOT-930 or FPM-300, an operator at the other end will be able to quickly locate the correct fiber or perform loss measurements. Refer to the power meter user guide for details.

To identify fiber faults visually:

1. Clean the connectors properly (see *Cleaning and Connecting Optical Fibers* on page 22).
2. Connect the fiber under test to the VFL port.
3. From the main window, press the  button.
4. Select **Continuous** to use the VFL with continuous output or **Blink** to use the VFL with 1 Hz pulsed output.

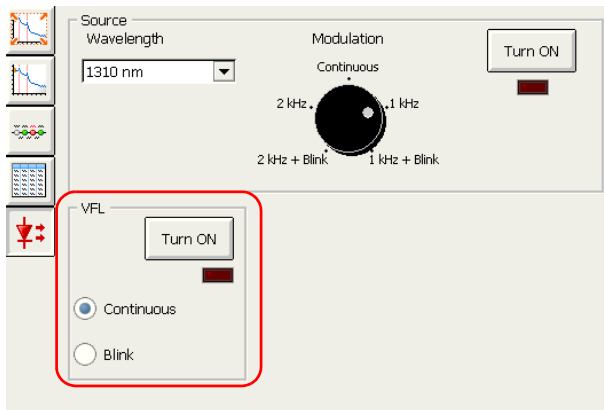

5. Under **VFL**, press **Turn ON** to send the VFL signal. You can stop the VFL signal emission at any time by pressing **Turn OFF**.

15 **Analyzing Traces with the Bidirectional Analysis Application**

Note: *The OTDR Bidirectional application is available from the **Test Tools** tab in Compact ToolBox.*

- The OTDR Bidirectional application helps you to perform a bidirectional analysis on two unidirectional OTDR traces. For the application to be able to match events, the two OTDR traces must have been acquired in opposite directions and on the same fiber span.

The application will perform a bidirectional analysis and generate an events table with the averaged loss for each event; that is, the average of the losses obtained from both directions.

You can also analyze OTDR traces with multiple wavelengths.

To work with the OTDR Bidirectional application, you must acquire and save the traces before the analysis.

Analyzing Traces with the Bidirectional Analysis Application

- Bidirectional analysis is the recommended method for splice loss measurements on singlemode fibers by the Telecommunications Industry Association (test procedure *EIA/TIA FOTP-61 Measurement of Fiber or Cable Attenuation Using an OTDR*).

This method removes the so-called “gainers” (increase in the optical power) and exaggerated losses and provides accurate measurements. This analysis is particularly useful to test the quality of a link, especially if it comprises several sections with different types of fibers or fibers from different manufacturers.

Gainers and exaggerated losses result from the joining of two fibers of different mode-field diameters (MFD). The mode-field diameter of a fiber corresponds to the size of the area where light is dispersed across its core and cladding.

Mismatch of MFDs will contribute to differences in back-reflected signal that are not related to the loss at the splice point, that is to the true loss seen in transmission. In this case, a unidirectional OTDR trace will show an apparent increase (gainer) or decrease (exaggerated loss) in signal, depending on the direction of measurement.

Bidirectional averaging of OTDR splice loss measurements provides the most accurate splice loss results.

Starting and Exiting the Bidirectional Analysis Application

The bidirectional analysis application is available from your unit.

To start the Bidirectional Analysis application:

- 1.** From Compact ToolBox, go to the **Test Tools** tab.
- 2.** Double-tap **OTDR Bidirectional**.

OR

Select **OTDR Bidirectional** and press **Start** (located at the bottom of the **Test Tools** tab).

Analyzing Traces with the Bidirectional Analysis Application

Starting and Exiting the Bidirectional Analysis Application

The main window is displayed.

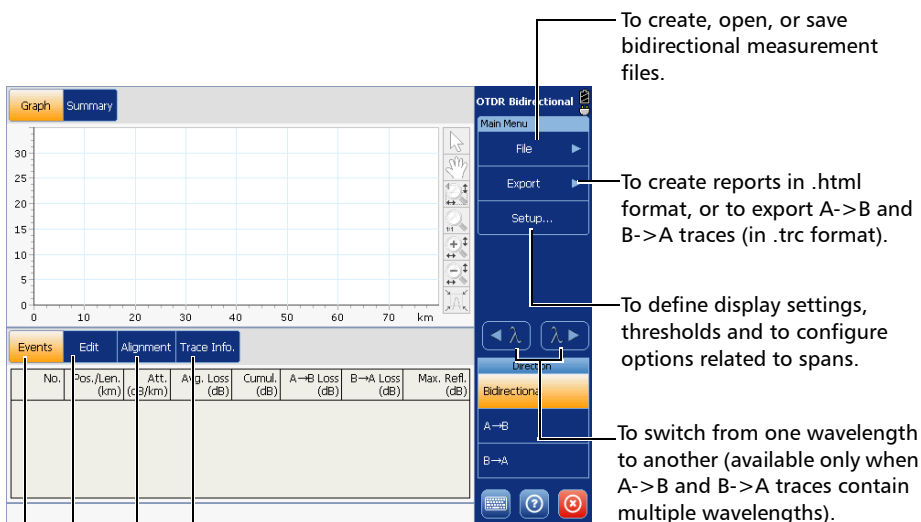

To create, open, or save bidirectional measurement files.

To create reports in .html format, or to export A->B and B->A traces (in .trc format).

To define display settings, thresholds and to configure options related to spans.

To switch from one wavelength to another (available only when A->B and B->A traces contain multiple wavelengths).

To view information about the current measurement, modify trace identification (A->B and B->A traces), or modify acquisition settings (A->B and B->A traces).

To view information about the matched events (bidirectional measurement), or to modify span start and span end (A->B and B->A traces).

To reanalyze the A->B and B->A traces and regenerate bidirectional measurement, or to manage events of A->B and B->A traces.

To view the table of events corresponding to the current direction, at the current wavelength.

To close the application from the main window:

Press  (in the bottom right corner of the main window).

Creating Bidirectional Measurement Files

To work with the OTDR Bidirectional application, you must acquire and save the traces (in the OTDR application) before opening them with the bidirectional analysis application.

You can open unidirectional trace files to combine them into a bidirectional measurement file. It is possible to use both single-wavelength and multiwavelength traces. However, once a multiwavelength trace file is recalled, it is converted to single-wavelength trace files. Bidirectional measurement files will automatically be created for each of the wavelengths.

Analyzing Traces with the Bidirectional Analysis Application

Creating Bidirectional Measurement Files

The A->B and B->A traces must respect the following criteria:

Item	To be valid...
Trace	<ul style="list-style-type: none">▶ Both must be unidirectional files (.trc or .sor files).▶ Only traces of native format or of Telcordia (Bellcore) EXFO version 200 format can be reanalyzed and be used to generate the bidirectional measurement.▶ You can open traces of Telcordia (Bellcore) non-EXFO version 200 format, but you cannot reanalyze them. However, they can be used to generate the bidirectional measurement.
Pulse width	Must be identical or adjacent for both traces. Pulses can be considered as adjacent when $\text{biggest pulse} \leq 4 \times \text{smallest pulse}$ (for example, 2.5 μs and 10 μs are adjacent, because 10 is equal to 2.5 x 4).
Fiber types	Use only traces acquired using <i>singlemode</i> fibers.
Acquisition offset	Must be set to zero for both traces.
Wavelengths	At least one wavelength must be common to both trace files. Only the wavelengths that are common to both traces will be used to generate the bidirectional measurement and will be saved along with the bidirectional file.

Note: The information such as the Cable ID and Fiber ID does not need to be the same in the A->B and B->A files for the application to be able to generate the bidirectional measurement.

Analyzing Traces with the Bidirectional Analysis Application

Creating Bidirectional Measurement Files

When two traces are opened in the bidirectional analysis application, the span end of the B->A trace is aligned with the span start of the A->B trace.

If the application cannot match the traces perfectly, error or warning messages will appear. A message will be displayed if there are inconsistencies in the events table, wavelength, index of refraction, helix factor, or Rayleigh backscatter coefficient.

Note: *The A->B and B->A traces are displayed in full view mode (1:1 zoom factor).*

Analyzing Traces with the Bidirectional Analysis Application

Creating Bidirectional Measurement Files

To create a **bidirectional measurement file**:

1. From the **Main Menu**, select **File > Create**.
2. Select the files to open.
 - 2a. Press the **Browse** button, on the right of the **A ->B** file path box.

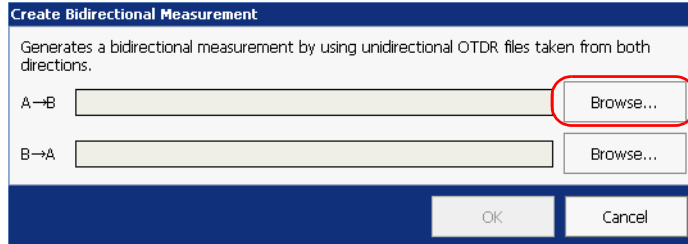

- 2b. Select the first file (ensure that it is highlighted) and press **Open**.

Note: The application will keep in memory the path to your A->B trace file. The next time you create a bidirectional measurement, the application will suggest this path by default.

- 2c. Press the **Browse** button, on the right of the **B->A** file path box.
- 2d. Select the second file (ensure that it is highlighted) and press **Open**.

Note: The application will keep in memory the path to your B->A trace file. The next time you create a bidirectional measurement, the application will suggest this path by default. This path is independent from the path to the A->B trace files.

3. Back to the **Create Bidirectional Measurement** dialog box, press **OK** to confirm.

The application will prompt you if some files have not been saved yet.

Opening Existing Bidirectional Measurement Files

You can open bidirectional measurement files to view results or to reanalyze them. When you open a bidirectional file, you will recover all the data of the unidirectional traces and the bidirectional measurement (one wavelength per bidirectional file).

Note: *The application will keep in memory the path to your bidirectional measurement file. The next time you open a bidirectional measurement, the application will suggest this path by default.*

To open an existing bidirectional measurement file:

- 1.** From the **Main Menu**, select **File > Open**.
- 2.** Select the desired file (ensure that it is highlighted) and press **Open**.

The application will prompt you if some files have not been saved yet.

Analyzing Traces with the Bidirectional Analysis Application

Displaying Traces and Bidirectional Measurement

Displaying Traces and Bidirectional Measurement

You can view, in turn, the bidirectional measurement as well as the unidirectional trace files. When you create a bidirectional measurement using multiwavelength files, you can also navigate through the different wavelengths.

To switch from one direction to another:

From the main window, under **Direction**, select the desired direction.

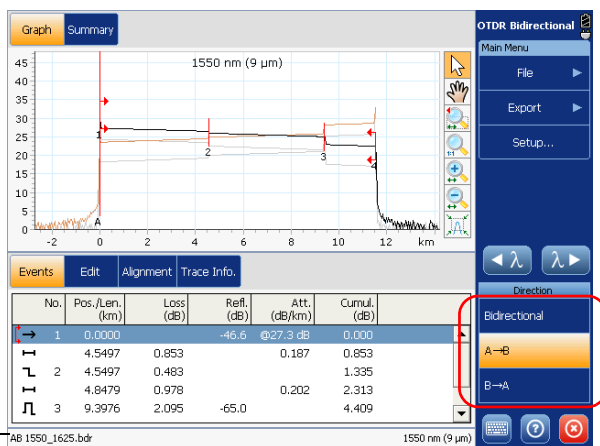



File name

Analyzing Traces with the Bidirectional Analysis Application

Displaying Traces and Bidirectional Measurement

To switch from one wavelength to another:

From the main window, use the   buttons.

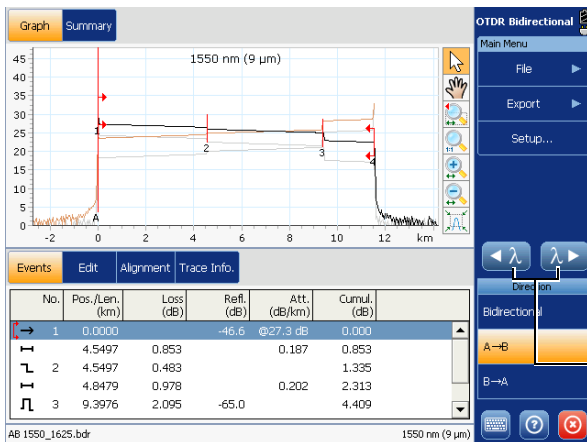

To switch from one wavelength to another (available only when A->B and B->A traces contain multiple wavelengths).

Note: You can also use  |  from the keypad.

Viewing Results

The application shows the results of the A->B and B->A traces according to the thresholds defined in the Bidirectional OTDR application. You can view the corresponding graphs (see *Graph View* on page 205) and tables of events (see *Events Tab* on page 208), as well as obtain more information about the status of the bidirectional measurement and/or A->B and B->A traces (see Summary Table).

There are many ways to view the results:

- Graph view
- Summary table

From the main window, you can also access the following tabs to have more information:

- Events
- Trace Info.

Graph View

The application shows the results both on a graph and in a table. The events, that are detailed in the events table (see *Events Tab* on page 208), are marked by numbers along the displayed trace.

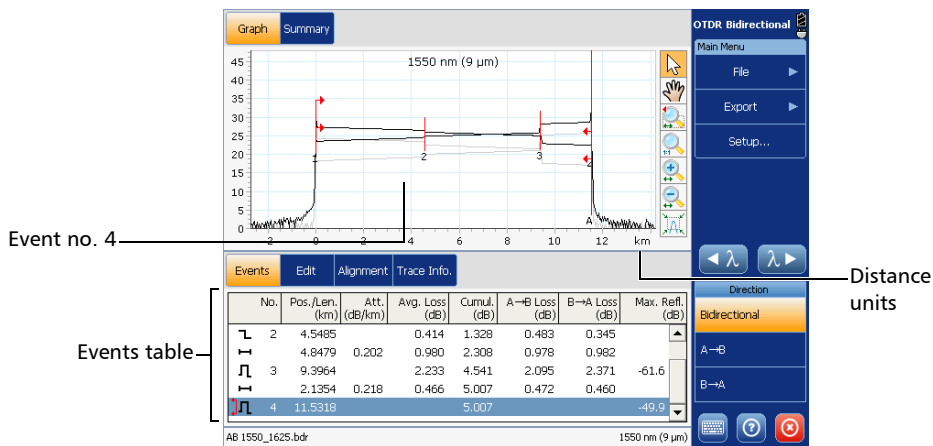

Some items in the trace display are always visible, while others will appear only if you choose to display them. The contents of the graph area changes according to the selected direction and wavelength.

You can change trace display parameters (such as the grid and zoom window display). For more information, see *Setting General Parameters* on page 240.

You can view all of the traces, in turn, in both the **Trace Info.** tab and the trace display with the navigation buttons. For more information, see *Displaying Traces and Bidirectional Measurement* on page 202.

To display the graph:

From the main window, select the **Graph** tab.

Analyzing Traces with the Bidirectional Analysis Application

Viewing Results

Summary Table

The summary table gives, for each wavelength and at each direction, the status of the results (pass: no results exceed the thresholds, or fail: at least one result exceeds the thresholds) and the span loss values. A global status for the bidirectional measurement is also available. The span length (distance between span start and span end) is also displayed. Values having a “fail” status appear in white on a red background.

Span length (corresponds to the greatest span length value among all bidirectional measurements, at all wavelengths)

Span loss of the bidirectional measurement

Wavelength (nm)	Direction	Status	Span Loss (dB)
1550	Bidirectional	Pass	5.007
	A→B	Pass	
	B→A	Pass	
1625	Bidirectional	Fail	7.316
	A→B	Fail	
	B→A	Fail	

No.	Pos./Len. (km)	Att. (dB/km)	Avg. Loss (dB)	Cumul. (dB)	A→B Loss (dB)	B→A Loss (dB)	Max. Ref. (dB)
1	0.0000		0.950	0.000			-44.7
2	4.5496	0.206	0.950	0.950	0.888	1.011	
	4.5496	0.854	1.804	0.933	0.775		
3	4.8478	0.211	1.023	2.827	1.029	1.017	
	9.3974	3.998	6.823	3.841	4.152	-62.1	

Wavelength and fiber type (between parentheses)

- When you select an element from the summary table (or if you switch to another wavelength or direction), the graph, as well as the contents of the **Events** and **Trace Info.** tabs are updated accordingly.
- In the summary table, when you select an element having a “fail” status (element is highlighted), if you press **Locate**, the application automatically switches to one of the following:
 - the graph view: The application zooms in on the first event or fiber section for which the status is “fail”.
 - the **Trace Info.** tab: The application highlights the row corresponding to the first element (span loss, span length, or span ORL) for which the status is “fail”.
 - You can press the **Details** button for further information on the element having a “fail” status.

Note: *Instead of pressing the **Locate** button, you can double-tap the element having a “fail” status.*

If you do not see any status (pass or fail), this probably means that no threshold was selected (see *Setting Pass/Fail Thresholds* on page 247), or that the only threshold that is selected is *Fiber section attenuation*, but the fiber sections are hidden (see *Customizing the Events Table* on page 243).

To display the summary table:

From the main window, select the **Summary** tab.

Analyzing Traces with the Bidirectional Analysis Application

Viewing Results

Events Tab

You can view information about all detected events on a trace and fiber sections by scrolling through the events table. In graph view, when you select an event in the events table, marker **A** appears on the trace over the selected event. When the selected event is a fiber section, this fiber section is delimited by two markers (**A** and **B**). For more information on markers, see *Using Markers to Edit Events* on page 225.

These markers pinpoint an event or a fiber section, depending on what is selected in the events table. You can move markers directly by selecting an element in the events table or on the graph. The application will automatically select the event or fiber section corresponding to the point you press on the graph.

The events table lists all the events detected on the fiber. An event can be defined as the point at which change in the transmission properties of light can be measured. Events can consist of losses due to transmission, splices, connectors or breaks. If the event is not within the established thresholds, its status will be set to “fail”.

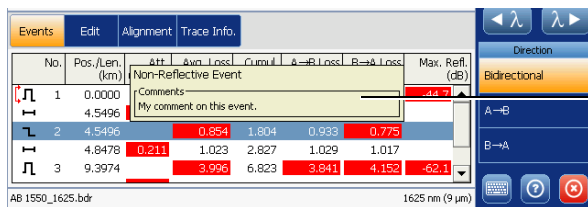

No.	Pos./Len. (km)	Att	Avn. Loss	Cumul.	A→B Loss	B→A Loss	Max. Refl. (dB)
1	0.0000						-4.4
Non-Reflective Event							
Comments							
My comment on this event.							
2	4.5496		0.854	1.804	0.933	0.775	
2	4.8478		0.211	1.023	2.827	1.029	1.017
3	9.3974		3.996	6.823	3.641	4.152	-62.1

Tooltip identifying the selected item

If you press and hold the row corresponding to a specific event or fiber section for a few seconds, the application will display a tooltip identifying the item (for example, Non-reflective event).

If an asterisk appears next to the event symbol, the tooltip will also show “(*:Modified)” to indicate that this event has been modified manually.

If the asterisk appears next to the event symbol, “(*:Added)” will appear to indicate that this event has been inserted manually.

For each item listed in the events table, information is displayed. The information vary depending on the direction that is selected.

Bidirectional measurement

Event type detected

(see *Description of Event Types* on page 297)

Event number

Position: distance between the OTDR and the measured event, or between the event and the beginning of the fiber span

OR

Length of a fiber section (distance between two events).

Attenuation (loss/distance) of individual fiber section

Current loss in dB

No.	Pos./Len. (km)	Att. (dB/km)	Avg. Loss (dB)	Cumul. (dB)	A→B Loss (dB)	B→A Loss (dB)	Max. Refl. (dB)
2	4.5485		0.414	1.328	0.483	0.345	
	4.8479	0.202	0.980	2.308	0.978	0.982	
3	9.3964		2.233	4.541	2.095	2.371	-63.6
	2.1354	0.218	0.466	5.007	0.472	0.460	
4	11.5318						-45.9

Average of the loss measured between A->B and B->A traces (most important information)

Cumulative loss from span start to span end; running total is provided at the end of each event and fiber section.

Maximum reflectance measured on the unidirectional traces

Analyzing Traces with the Bidirectional Analysis Application

Viewing Results

Unidirectional traces

Event type detected
(see *Description of Event Types* on page 297)

Event number

Position: distance between the OTDR and the measured event, or between the event and the beginning of the fiber span
OR
Length of a fiber section (distance between two events).

Loss in dB for each event or fiber section

Reflectance measured at each reflective event along the fiber

Injection level

No.	Pos./Len. (km)	Loss (dB)	Ref. (dB)	Att. (dB/km)	Cumul. (dB)
1	0.0000		-46.6	@27.3 dB	0.000
2	4.5497	0.853		0.187	0.853
2	4.5497	0.483			1.335
3	4.8479	0.978		0.202	2.313
3	9.3976	2.095	-65.0		4.409

Attenuation (loss/distance) of individual fiber section

Cumulative loss from span start to span end; running total is provided at the end of each event and fiber section.

Note: *The attenuation value is always presented in dB per kilometers even if the distance units you selected are not the kilometers. This follows the standards of the fiber-optic industry that provides the attenuation values in dB per kilometers.*

Cumulative loss is calculated for the events displayed in the events table. For the loss value of the complete link (fiber span), refer to the loss measurement displayed in the **Trace Info.** tab.

If you want to modify events or fiber sections, see *Modifying Events* on page 231, *Inserting Events* on page 227, and *Changing the Attenuation of Fiber Sections* on page 237.

To quickly locate an event in the events table:

1. Ensure that the  button is selected in the zoom button bar.
2. Select the event on the trace.

The list scrolls automatically to the event you selected.



Analyzing Traces with the Bidirectional Analysis Application

Viewing Results

Trace Info. Tab

You can view information about the bidirectional measurement as well as the A->B and B->A traces (see *Displaying Traces and Bidirectional Measurement* on page 202). However, you can only modify the analysis settings for the current A->B and B->A traces, not for the bidirectional measurement (see *Modifying Trace Analysis Settings* on page 252).

To view information about the bidirectional measurement or a specific trace:

1. From the main window, select the **Trace Info.** tab.
2. Under **Direction**, select the desired direction.

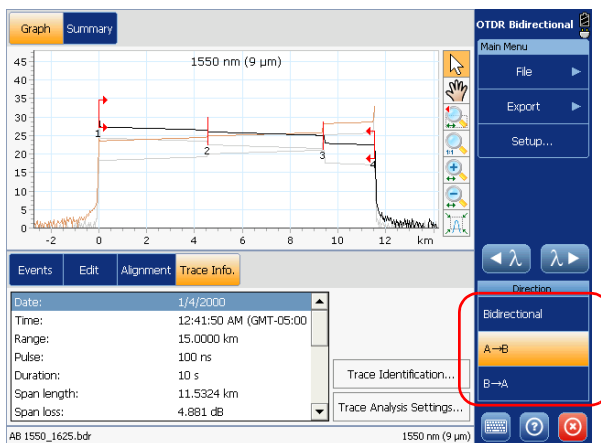

The following information is available:

- **Pulse:** Pulse width used to perform the acquisition.
- **Span length:** Measured length of the total fiber span (between span start and span end).
- **Span loss:** Total measured loss of the fiber calculated either between the span start and the span end, or on the total fiber span, depending on the settings you have chosen in the setup window.
- **Average loss:** Average loss of the total fiber span as a function of distance.
- **Average splice loss:** Average of all non-reflective events between span start and span end.
- **Maximum splice loss:** Maximum value of all non-reflective events between span start and span end.

Analyzing Traces with the Bidirectional Analysis Application

Viewing Results

Information specific to the A->B or B->A trace is also displayed:

- **Range:** Acquisition range.
- **Duration:** Duration of the acquisition.
- **Span ORL:** ORL calculated either between the span start and the span end, or on the total fiber span, depending on the option you have selected in the **Setup** window.
- **High resolution:** Indicates whether or not the acquisitions were performed using the high-resolution feature.
- **IOR:** Index of refraction of the displayed trace.
- **Backscatter:** Rayleigh backscatter coefficient of the displayed trace.
- **Helix factor:** Helix factor setting of the displayed trace.
- **Splice loss detection:** Splice loss threshold for detecting small non-reflective events during trace analysis.
- **Reflectance detection:** Reflectance threshold for detecting small reflective events during trace analysis.
- **End-of-fiber detection:** End-of-fiber threshold for detecting important event loss, which could compromise signal transmission, during trace analysis.

Reanalyzing Traces and Regenerating the Bidirectional Measurement

You can analyze the A->B and B->A traces and regenerate the bidirectional measurement at any time. Reanalyzing a trace will:

- re-create the events table if it was modified.
- reset the span start to zero and the span end to end-of-fiber, unless you have saved them (see *Saving the Span-Start and Span-End Information* on page 246).

The table below shows what happens when you start the analysis, depending on the direction that is currently selected.

Current direction	Bidirectional measurement	A->B trace	B->A trace
Bidirectional	Regenerated	Reanalyzed	Reanalyzed
A->B	Regenerated	Reanalyzed	Not modified
B->A	Regenerated	Not modified	Reanalyzed

Note: *In the case of multiwavelength files, the analysis is performed for the selected wavelength only.*

If you prefer to focus your analysis on a specific fiber span, see *Modifying the Alignment of Unidirectional Traces* on page 217.

Analyzing Traces with the Bidirectional Analysis Application

Reanalyzing Traces and Regenerating the Bidirectional Measurement

To reanalyze traces and regenerate bidirectional measurement:

1. From the main window, select the **Edit** tab.
2. Under **Direction**, select the desired option, depending on which trace you want to reanalyze.

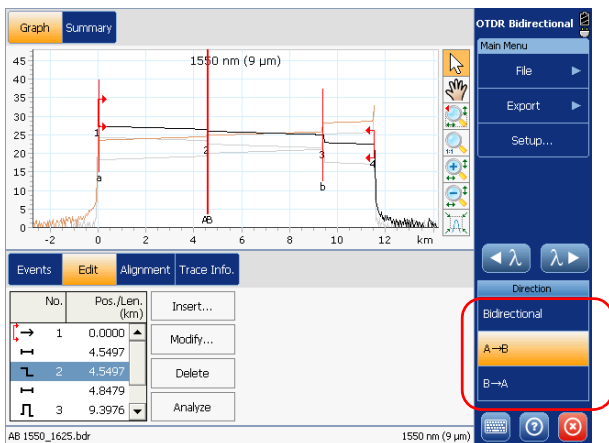

3. If you are working with a multiwavelength file, select the desired wavelength using the  buttons.
4. Press the **Analyze** button.
5. When the application prompts you, select **Yes** to complete the operation.

Modifying the Alignment of Unidirectional Traces

When two unidirectional traces are opened in the bidirectional analysis application, the span end of the B->A trace is aligned with the span start of the A->B trace. However, you may want to modify the way traces are aligned by redefining the span start and/or span end of one or both of the unidirectional traces.

Keep in mind that when you modify the B->A trace, the trace is presented in the opposite direction of the A->B trace, and so are the events.

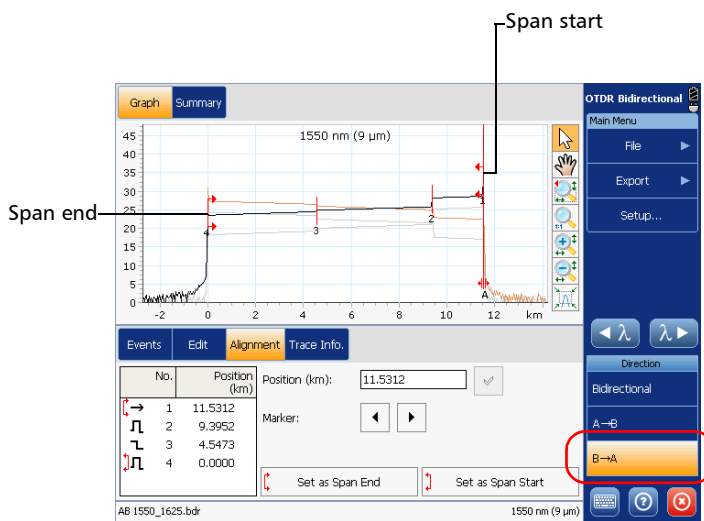

Note: The icons used in the small table of events for the B->A trace follows the standard for the event types (see Description of Event Types on page 297). For this reason, they do not match the symbols used on the graph.

You can define events (new or existing) as a span start and/or span end. You can even define a fiber span for short fibers by placing the span start and the span end on the same event.

Analyzing Traces with the Bidirectional Analysis Application

Modifying the Alignment of Unidirectional Traces

You can even set the span end after the detected end of fiber. This could be useful if you suspect problems in this section of the trace or if the actual end of fiber seems to be located in the noise (peak detected at the end of the fiber span). The end of fiber will be moved accordingly. However, if you move the span end back within the original fiber span, the end of fiber will remain at its current location (it will not be moved back with this new span end).



IMPORTANT

If you reanalyze a trace, the position of the fiber end will be reset and the events table will be re-created.

The application will refresh the graph to reflect the new span start and span end positions automatically.

Analyzing Traces with the Bidirectional Analysis Application

Modifying the Alignment of Unidirectional Traces

To modify the alignment of A->B or B->A trace:

1. From the main window, select the **Alignment** tab.
2. Under **Direction**, select **A->B** or **B->A**.

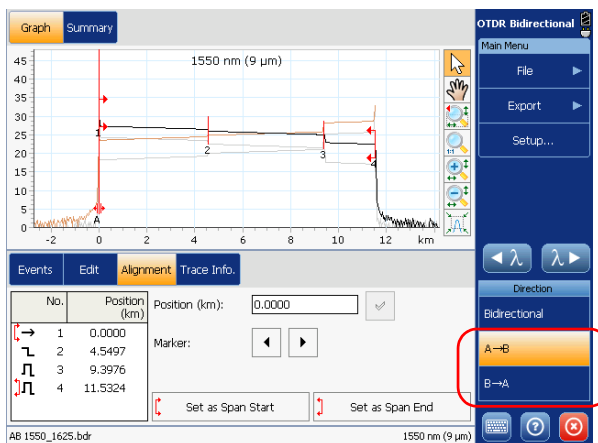

3. Define the span event location by moving marker A along the trace using one of the following methods:
 - Drag marker A to the desired span event location.
 - Use the selection dial (located on the front of the unit) to move marker A.
 - Enter a distance value in the **Position** box, and press .
 - Use the single-arrow buttons to move marker A on the trace.
 - From the small table of events, press directly the row corresponding to the existing event that you would like to designate as a span event.

Note: Each of these elements may lead to the creation of a new event, except the new location corresponds to an already existing event on the trace.

Analyzing Traces with the Bidirectional Analysis Application

Modifying the Alignment of Unidirectional Traces

4. Press **Set as Span Start** or **Set as Span End** to set the span start or span end marker on the appropriate event in the trace display.



IMPORTANT

To keep a set fiber span during trace reanalysis, activate the corresponding option (see *Saving the Span-Start and Span-End Information* on page 246). Otherwise, the span start and span end markers are reset to zero in the process.

Changes to the span start and span end will modify the contents of the events table. For the A->B trace, the span start becomes event 1 and its distance reference becomes 0. For the A->B trace, the span end becomes the last event and its distance reference becomes 0.

Only events between the span start and span end will be numbered in the trace display and events table. The cumulative loss is calculated within the defined fiber span only.

Using Zoom Controls

You can use the zoom controls to change the scale of the trace display.

You can zoom in on or out of the graph using the corresponding buttons or let the application automatically adjust the zoom on the currently selected event from the events table.

You can also return to the original graph value.

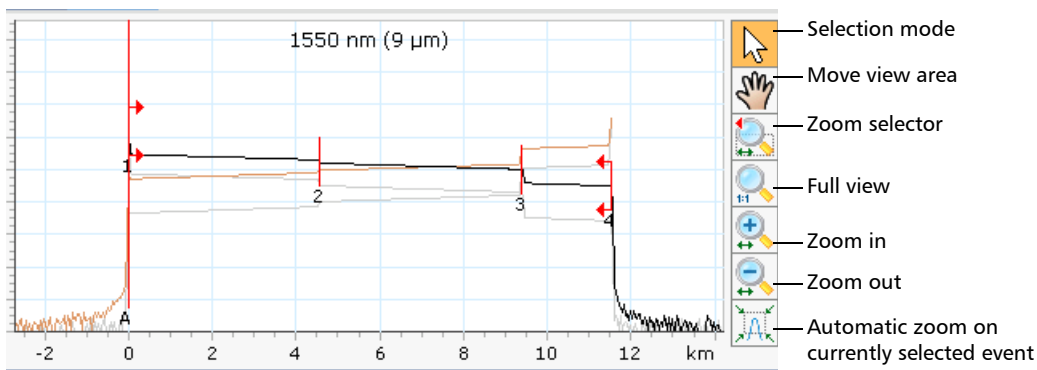

Note: You cannot move the markers with the  button.

- In the case of a multiwavelength file, when you zoom in or out on the graph, the application will apply the new zoom context (zoom factor, selected area, and selected event when applicable) to the other bidirectional measurements (wavelengths). Only the zoom context of the bidirectional measurement will be saved along with the bidirectional file.

Analyzing Traces with the Bidirectional Analysis Application

Using Zoom Controls

- When you zoom in or out on an event, the application keeps the zoom on this event until you select another event or change the zoom position. In the case of a multiwavelength file, you can select a different event for each wavelength (for example, event 2 at 1550 nm and event 5 at 1625 nm). Only the selected events of the bidirectional measurement will be saved along with the bidirectional file.
- When you open an existing bidirectional file, the application restores the zoom context of the bidirectional measurement. This zoom context will also be applied to the A->B trace. The B->A trace will be displayed in complete graph view and event 1 will be selected.
- If the  button is selected, as soon as you open another bidirectional file, the option will be deselected. This will allow the application to restore the zoom context that was saved along with the measurement.



To view specific portions of the graph:

- You can define which portion of the graph will be visible by selecting the  button and dragging the graph with the stylus or your finger.

This could be useful, for example, if you want to zoom in on events located outside the defined fiber span.

- The  button is the zoom selector. It allows you to select whether the zooming will be performed according to the horizontal axis, the vertical axis, or both.

Press and hold this button to select the zooming direction in the menu. Then, define the zoom area with the stylus or your finger (a rectangle with dotted lines will appear to help you define the area). Once you release the stylus, the application automatically zooms in on the graph according to the zooming type you have selected.. All of the other zoom buttons (except for the zoom on selected event button) will reflect your selection and behave accordingly.

- You can zoom in or out on the graph by first using, respectively, the  or the  button, and then by pressing the location where you want to zoom on the graph with the stylus or your finger. The application automatically adjusts the zoom by a factor 2 around the point that was pressed.

Analyzing Traces with the Bidirectional Analysis Application

Using Zoom Controls

To automatically zoom in on the selected event:

1. From the main window, select the **Graph** tab.
2. Select the **Events** tab.
3. Under **Direction**, select the desired option.
4. From the events table, select the desired event.

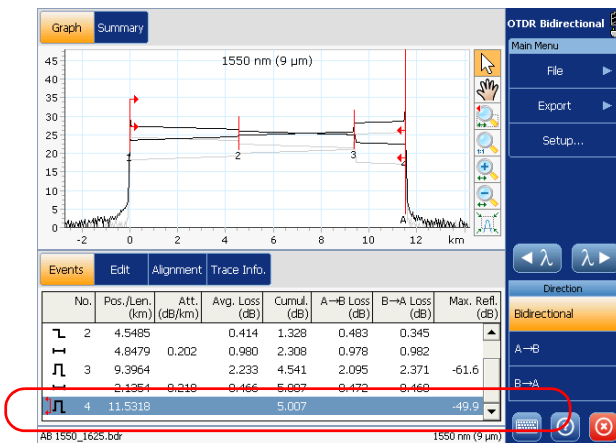

5. Press  to automatically adjust the zoom factor.

The button remains selected until you deselect it, or open another bidirectional file.

To revert to the complete graph view:

Press the  button.

Using Markers to Edit Events

You can use markers to define or modify the position of an event on the A->B or B->A trace.

Markers are available when you modify or add an event.

If two markers are located at the same place, both will move together.

To move a marker:

1. If you intend to move the markers directly from the graph, ensure that the  button is selected in the zoom button bar.
2. From the **Edit** tab, press the buttons corresponding to the markers that you want to move. The buttons will turn yellow, indicating that a specific marker is selected.

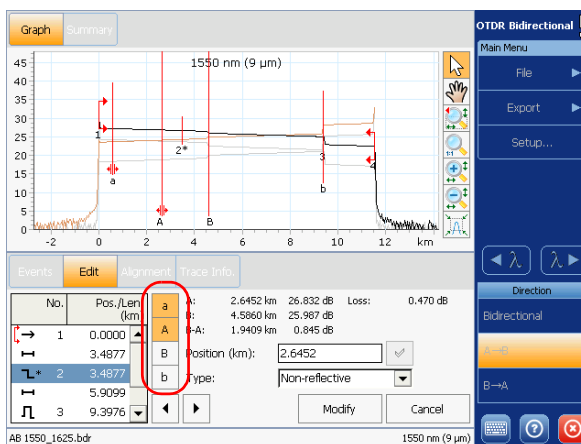

Selecting marker **A** or **B** will move the **a-A** or **B-b** pair. However, it is possible to only move the **a** or **b** marker by pressing on the corresponding button. You can also select the four markers if you want to move all of them at the same time.

Analyzing Traces with the Bidirectional Analysis Application

Using Markers to Edit Events

- Once the appropriate markers are selected, use one of the following methods to move them along the trace:
 - ▶ Drag markers to the desired location directly on the graph using the stylus or your finger.
 - ▶ Use the selection dial (located on the front of the unit).
 - ▶ Use the single-arrow buttons.
 - ▶ Enter a distance value in the **Position** box, and press .

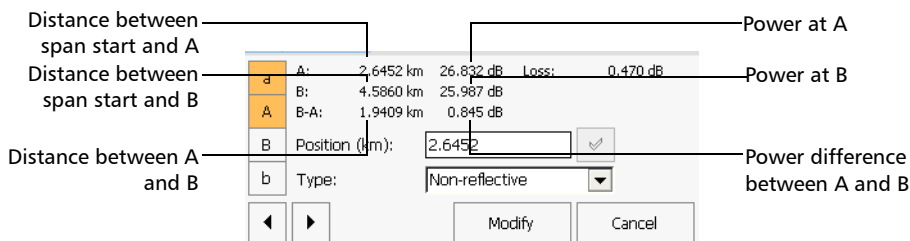

The screenshot shows a data table and a configuration dialog. The data table has the following content:

A:	2.6452 km	26.832 dB	Loss:	0.470 dB
B:	4.5860 km	25.987 dB		
B-A:	1.9409 km	0.845 dB		

The configuration dialog shows the following fields:

- Position (km): 2.6452
- Type: Non-reflective
- Buttons: Modify, Cancel

Labels on the left side of the image point to various parts of the interface:

- Distance between span start and A
- Distance between span start and B
- Distance between A and B

Labels on the right side of the image point to various parts of the interface:

- Power at A
- Power at B
- Power difference between A and B

Note: Keep in mind that when you work with the B->A trace, the trace is presented in the opposite direction of the A->B trace, and so are the markers. For example, instead of having the distance between span start and A as the first element, you would have the distance between span start and B. As another example, instead of having the distance between A and B, you would have the distance between B and A.

Inserting Events

Note: *You can only create events for the A->B or B->A trace (not for the bidirectional measurement). The application regenerates the bidirectional measurement automatically to take into account the modifications you have made.*

You can insert events in the events table manually.

This could be useful, for example, if you know that there is a splice at a given location, but the analysis does not detect it because it is hidden in the noise or because the splice loss is lower than the minimum detection threshold (see *Setting Pass/Fail Thresholds* on page 247). If you create this event, the application will add a number on the trace at the location of the insertion, but it will *not* modify the trace.



IMPORTANT

Inserted events are removed when you reanalyze a trace.

Analyzing Traces with the Bidirectional Analysis Application

Inserting Events

To insert an event:

1. From the main window, select the **Edit** tab.
2. Under **Direction**, select either **A->B** or **B->A**.
3. If desired, you can select an item from the events table that is near the location where you want to insert an event.

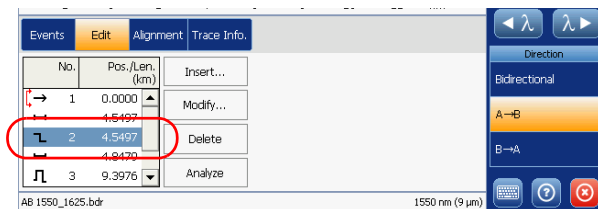

4. Press the **Insert** button.

5. Specify the exact location where you want to insert an event.

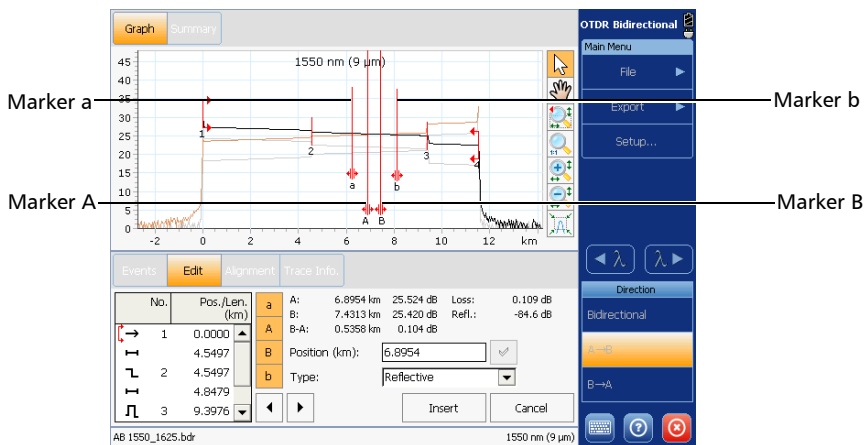

Four markers are available to help you place the event, but only marker A identifies where the event will be inserted. Define the new event location by using one of the following methods:

- Enter a distance value in the **Position** box, and press .
- Move the markers on the trace display. For more information on positioning markers, see *Using Markers to Edit Events* on page 225.

Analyzing Traces with the Bidirectional Analysis Application

Inserting Events

- Once you have determined the location, from the **Type** list, select the desired event type.

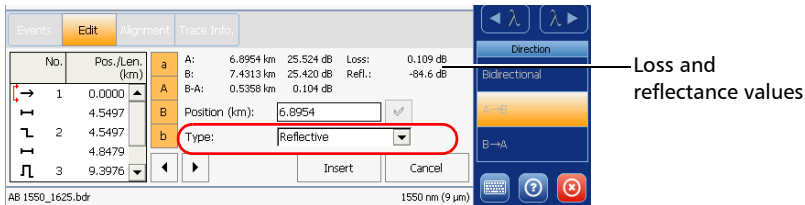

Loss and reflectance are calculated automatically, based on the position of the markers. Reflectance values are only displayed for reflective event types (reflective, echo, and possible echo).

- Press **Insert** to create the event or **Cancel** to return to the events table without making any changes.

Inserted events are identified with “*” (appearing beside the event symbol) in the events table of both **Edit** and **Events** tabs as shown below.

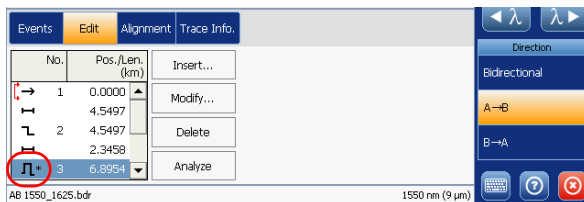

Modifying Events

Note: *You can only modify the events of the A->B or B->A trace (not those of the bidirectional measurement). The application regenerates the bidirectional measurement automatically to take into account the modifications you have made.*

You can change the position as well as the loss and reflectance (reflective events only) of almost any existing event except:

- launch event (You can modify the loss and reflectance values, but not its position. The launch event position must always remain set to 0.)
- continuous fiber
- end of analysis
- merged events



IMPORTANT

If you reanalyze a trace, all of the modified events will be lost and the events table will be re-created.

Note: *If you want to modify the attenuation value of a fiber section, see [Changing the Attenuation of Fiber Sections](#) on page 237.*

Analyzing Traces with the Bidirectional Analysis Application

Modifying Events

To modify an event:

1. From the main window, select the **Edit** tab.
2. Under **Direction**, select either **A->B** or **B->A**.
3. Select the event you want to modify.

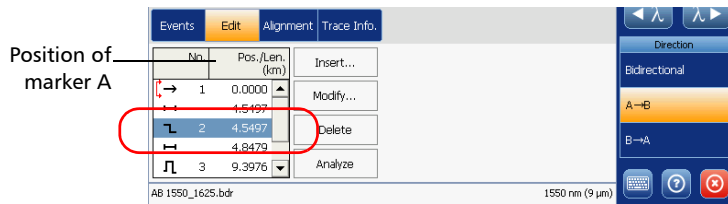

4. Press the **Modify** button.

Note: If the **Modify** button is not available, that means you cannot modify events of this type.

5. If desired, specify a new location for the selected event.

Note: You cannot select another event from the events table of the **Edit** tab in modification mode. If you want to modify another event instead, press **Cancel**, then change your selection.

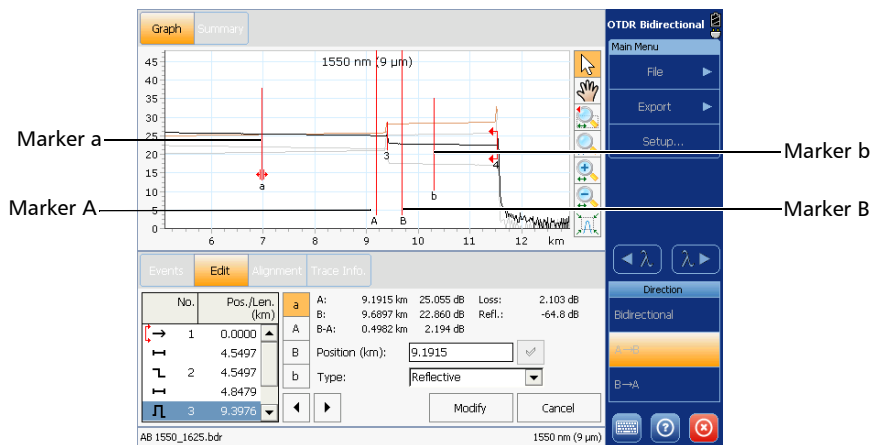

Four markers are available to help you place the event, but only marker **A** identifies where the event will be moved. Define the new location by using one of the following methods:

- Enter a distance value in the **Position** box, and press .
- Move the markers on the trace display. For more information on positioning markers, see *Using Markers to Edit Events* on page 225.

Deleting Events

Note: *You can only delete events from the A->B or B->A trace (not from the bidirectional measurement). The application regenerates the bidirectional measurement automatically to take into account the modifications you have made.*

Almost any element can be deleted from the events table, except:

- end of analysis
- fiber section
- launch level
- end of fiber
- span start
- span end



IMPORTANT

The only way to “recover” deleted items is to reanalyze the trace. For more information, see *Reanalyzing Traces and Regenerating the Bidirectional Measurement* on page 215.

Analyzing Traces with the Bidirectional Analysis Application

Deleting Events

To delete an event:

1. From the main window, select the **Edit** tab.
2. Under **Direction**, select either **A->B** or **B->A**.
3. Select the event you want to delete.

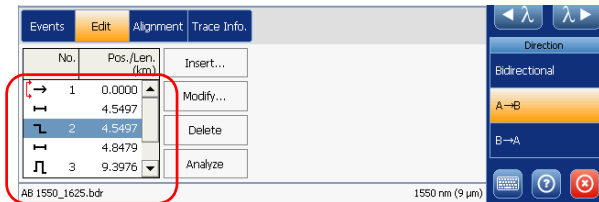

4. Press **Delete**.

Note: If the **Delete** button is not available, that means you cannot delete events of this type.

5. When the application prompts you, press **Yes** to confirm the deletion, or **No** to keep the event.

Changing the Attenuation of Fiber Sections

Note: *You can only modify the sections of the A->B or B->A trace (not those of the bidirectional measurement). The application regenerates the bidirectional measurement automatically to take into account the modifications you have made.*

You can change the attenuation value of fiber sections.



IMPORTANT

If you reanalyze a trace, all of the modifications made to the fiber sections will be lost and the events table will be re-created.

Note: *If you want to modify events, see [Modifying Events](#) on page 231.*

Analyzing Traces with the Bidirectional Analysis Application

Changing the Attenuation of Fiber Sections

To modify the attenuation of a fiber section:

- 1.** From the main window, select the **Edit** tab.
- 2.** Under **Direction**, select either **A->B** or **B->A**.
- 3.** Select the fiber section that you want to modify.
- 4.** Press the **Modify** button.

The **A** and **B** markers appear in the trace display.

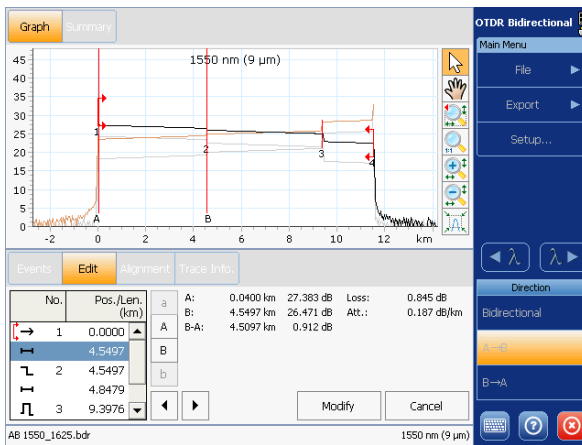

Analyzing Traces with the Bidirectional Analysis Application

Changing the Attenuation of Fiber Sections

5. Position markers as desired to modify the attenuation value. For more information on positioning markers, see *Using Markers to Edit Events* on page 225.

Note: *The markers serve only to set the new attenuation value. Their actual locations will not be modified.*

Fiber section loss and attenuation are displayed.

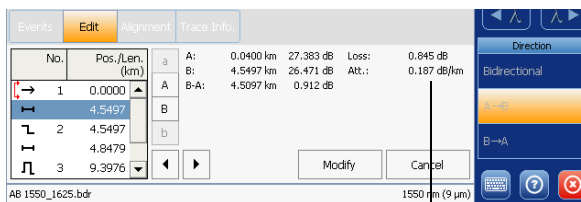

Loss and attenuation values

6. Press **Modify** to accept the modifications you have made or **Cancel** to return to the events table without saving the changes.

The modified fiber sections are identified with "*" in the events table of both **Edit** and **Events** tabs as shown below.

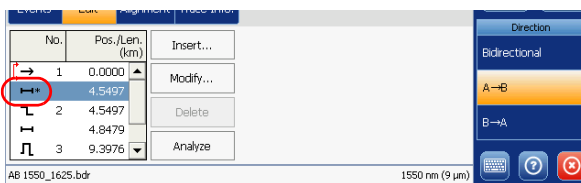

Setting General Parameters

You can set preferences such as:

- **Distance unit:** You can select the measurement units that will be used throughout the application, except for certain values such as the pulse and the wavelength. By convention, these values are always expressed in meters (nanometers for the wavelengths). The default distance units are the kilometers.

Note: *If you select Kilometers (km) or Kilofeet (kft), m and ft may appear instead to display more precise measurements.*

Note: *The attenuation of fiber sections is always presented in dB per kilometer even if the distance units you selected are not the kilometers. This follows the standards of the fiber-optic industry that provides the attenuation values in dB per kilometer.*

- **Pulse width unit:** You can select the unit that is used in the **Trace Info.** tab to express the pulse value. The pulse value can be expressed in units of time or distance.

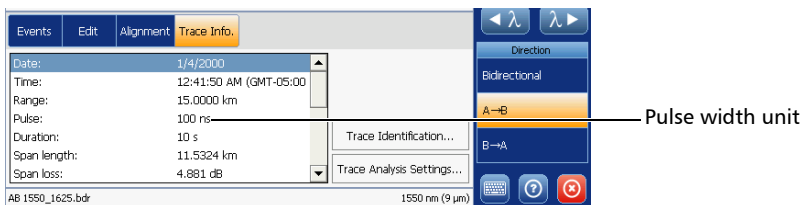

Analyzing Traces with the Bidirectional Analysis Application

Setting General Parameters

- the gridlines: You can display or hide the grid appearing on the graph's background. By default, the gridlines are displayed.

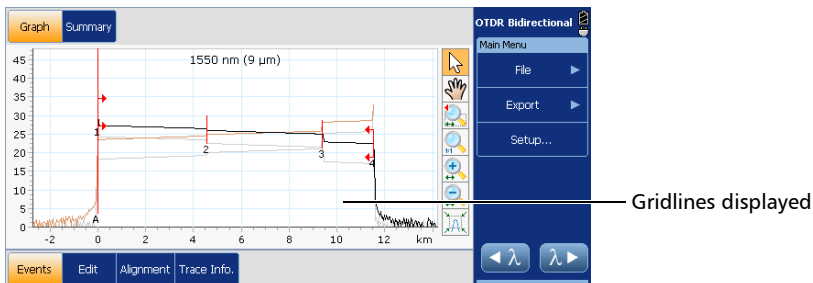

- the graph background: You can display the graph with a black (invert color feature) or a white background. By default, the background is white.
- Trace display mode: You can choose the way the application will display traces on-screen and in reports. The available choices are:
 - **Complete Trace:** to display the whole trace and full acquisition distance.
 - **Span:** to display the trace from the span start to the span end.

Analyzing Traces with the Bidirectional Analysis Application

Setting General Parameters

To set the general parameters:

1. From the **Main Menu**, select **Setup**, then select the **General** tab.
2. Select the boxes corresponding to the item you want to display on the graph.

OR

To hide them, clear the boxes.

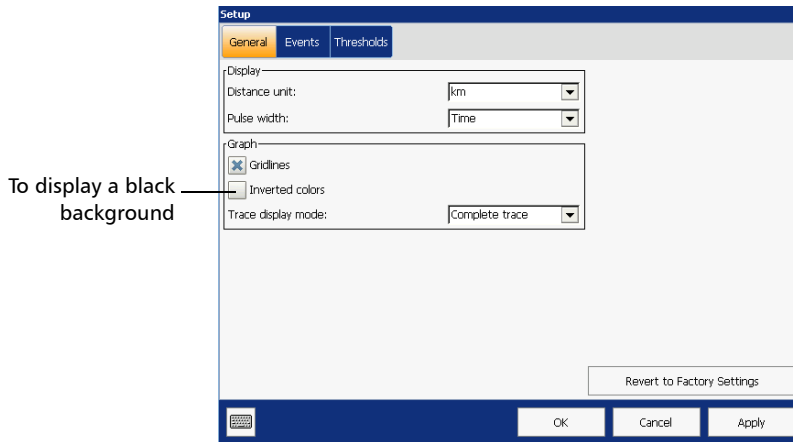

3. Press **Apply** to confirm the changes, then **OK** to return to the main window.

The changes are applied automatically.

To revert to factory default settings:

1. From the **Main Menu**, select **Setup**, then select the **General** tab.
2. Press the **Revert to Factory Settings** button.

Note: Only the parameters from the current tab have been reset.

Customizing the Events Table

You can include or exclude items from the events table to better suit your needs. By default, all items are selected.

- *Include span start and span end loss:* When applicable, the application will include the losses caused by the span start and span end events in the displayed values.

If you activated the pass/fail test (see *Setting Pass/Fail Thresholds* on page 247), span-start and span-end events will be taken into account when determining the status (pass/fail) of splice and connector loss, and reflectance.

- *Fiber sections:* You can display or hide fiber sections in the events table, depending on the types of values you want to display.

For example, by hiding the fiber sections, you can obtain the running total of connector and splice losses instead of having a loss value for the entire link.

Note: *Hiding the fiber sections will not delete these items.*

Analyzing Traces with the Bidirectional Analysis Application

Customizing the Events Table

- **Injection level:** In the events table, the injection level is represented by the → icon. In the **Att.** column, the injection level value for that event is identified by the @ symbol.

You can hide the injection level value and symbol from the **Att.** column, but not the → icon.

No.	Pos./Len. (km)	Loss (dB)	Refl. (dB)	Att. (dB/km)	Cumul. (dB)
→ 1	0.0000		-46.6	@27.3 dB	0.000
↔ 1	4.5497	0.953		0.187	0.653
↔ 2	4.5497	0.483			1.335
↔ 2	4.8479	0.978		0.202	2.313
↔ 3	9.3976	2.095	-65.0		4.409

- **Event:** You can display or hide the comments relative to a specific event. Such comments would be displayed in a tooltip along with the details of the event type (see *Events Tab* on page 208).

A red triangle appears next to the event number to indicate that a comment has been inserted manually for a specific event.

Note: If you have not selected the **Show event comment in tooltip** option in the **Events setup tab**, the red triangles will not appear even if there are comments.

No.	Pos./Len. (km)	Att.	Loss	Cumul.	A=B Loss	B=A Loss	Max. Refl. (dB)
↔ 1	0.0000						-44.7
↔ 1	4.5496						
↔ 2	4.5496	0.854	1.804	0.932	0.775		
↔ 2	4.8478	0.211	1.023	2.827	1.029	1.017	
↔ 3	9.3974		3.996	6.823	3.841	4.152	-62.1

To add or modify comments about events, you must use either FastReporter or the application of the OTDR for the FTB-500.

To customize the events table appearance:

1. From the **Main Menu**, select **Setup**, then select the **Events** tab.
2. Select the boxes corresponding to the item you want to display or include in the table.

OR

To hide them, clear the boxes.

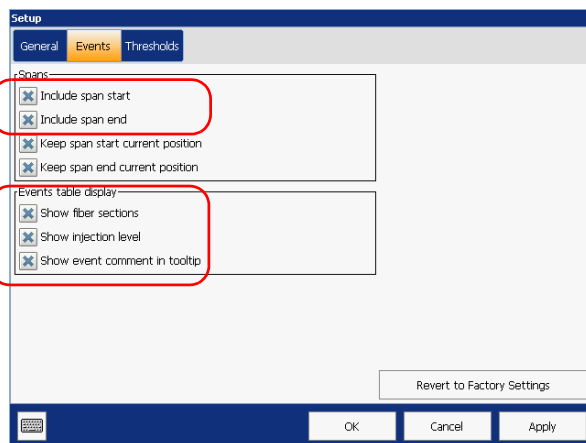

3. Press **Apply** to confirm the changes, then **OK** to return to the main window.

To revert to factory default settings:

1. From the **Main Menu**, select **Setup**, then select the **Events** tab.
2. Press the **Revert to Factory Settings** button.

Note: Only the parameters from the current tab have been reset.

Saving the Span-Start and Span-End Information

Saving the modified span-start and span-end information allows you to reapply the current span start and span end to a unidirectional trace when you reanalyze this trace.

To save the span-start and/or span-end information or to deactivate the feature:

1. From the **Main Menu**, select **Setup**, then select the **Events** tab.
2. Select the **Keep span start current position** and/or the **Keep span end current position** boxes.

OR

If you prefer not to save the span positions, clear the boxes.

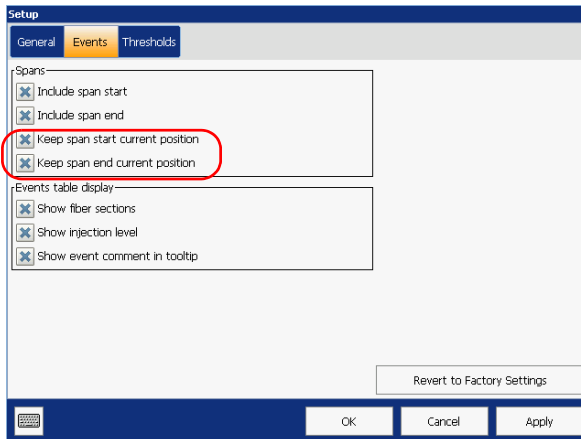

3. Press **Apply** to confirm the changes, then **OK** to return to the main window.

Setting Pass/Fail Thresholds

You can activate and set Pass/Fail threshold parameters for your traces and measurements. These thresholds are part of the OTDR Bidirectional application (not of the bidirectional files). This means that once you have set them, you can reuse them as many times as you want with other files.

You can set thresholds for splice loss, connector loss, reflectance, fiber section attenuation, span loss, span length, and span ORL. You can apply the same pass/fail thresholds to several test wavelengths or apply them separately to each one.

You can set different pass/fail thresholds for each available wavelength. These pass/fail thresholds will be applied to the results of the A->B or B->A traces as well as the bidirectional measurement with the corresponding wavelength.

By default, the application provides threshold values for the following wavelengths: 1310 nm, 1383 nm, 1390 nm, 1410 nm, 1490 nm, 1550 nm, 1625 nm, and 1650 nm. However, if you work with unidirectional or bidirectional files containing other wavelengths, the application will automatically add these custom wavelengths to the list of available wavelengths. You will then be able to define thresholds for these new wavelengths. You can revert all thresholds to their default values, except if they are associated with custom wavelengths.

The loss, reflectance and attenuation thresholds that you set are applied to all events where such values can be measured. Setting these thresholds allows you either to ignore events with known lower values, or to ensure that all events are detected—even the ones for which very small values are measured.

Analyzing Traces with the Bidirectional Analysis Application

Setting Pass/Fail Thresholds

The following table provides the default, minimum and maximum thresholds.

Test	Default	Minimum	Maximum
Splice loss (dB)	1.000	0.015	5.000
Connector loss (dB)	1.000	0.015	5.000
Reflectance (dB)	-40.00	-80.0	0.0
Fiber section attenuation (dB/km)	0.400	0.000	5.000
Span loss (dB)	45.000	0.000	45.000
Span length (km)	0.0000	0.0000	300.0000
Span ORL (dB)	15.00	15.00	40.00

Once the thresholds are set, the application will be able to perform Pass/Fail to determine the status of the various events (pass or fail).

Values that are greater than the predefined fail thresholds are displayed in white on a red background in the events table.

The Pass/Fail threshold LED, located on the front of the unit, will also indicate the status (green for pass, red for fail).

To set pass/fail thresholds:

1. From the **Main Menu**, select **Setup**, then select the **Thresholds** tab.
2. From the **Wavelength** list, select the wavelength for which you want to set thresholds.

The screenshot shows the 'Setup' dialog box with the 'Thresholds' tab selected. The 'Wavelength' dropdown is set to '1550 nm'. Below it, several threshold settings are listed with checkboxes and numerical input fields:

Threshold Type	Value	Unit
<input checked="" type="checkbox"/> Splice loss:	1.000	dB
<input checked="" type="checkbox"/> Connector loss:	1.000	dB
<input checked="" type="checkbox"/> Reflectance:	-40.0	dB
<input checked="" type="checkbox"/> Fiber section attenuation:	0.400	dB/km
<input checked="" type="checkbox"/> Span loss:	45.000	dB
<input checked="" type="checkbox"/> Span length:	0.0000	km
<input checked="" type="checkbox"/> Span ORL:	15.00	dB

Annotations in the image:

- A red circle highlights the 'Wavelength: 1550 nm' dropdown.
- A line points from the text 'Threshold to set' to the 'Fiber section attenuation' checkbox.
- A line points from the text 'Value associated with the threshold to set' to the '0.400' value field.

Buttons at the bottom: Copy to Other Wavelengths..., Revert to Factory Settings, OK, Cancel, Apply.

3. Select the boxes corresponding to the thresholds that you want to use, and enter the desired values in the appropriate fields.

Note: If you no longer want the application to take into account a particular threshold, simply clear the corresponding box.

Analyzing Traces with the Bidirectional Analysis Application

Setting Pass/Fail Thresholds

4. If you want to apply the thresholds you have just defined to one or several other wavelengths, proceed as follows:
 - 4a. Press the **Copy to Other Wavelengths** button.
 - 4b. Select the boxes corresponding to the wavelengths for which you want to use the same thresholds.

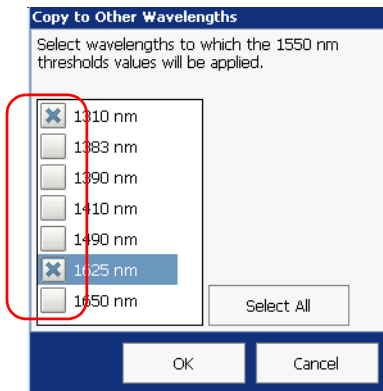

Note: You can use the **Select All** button to quickly select all boxes at the same time.

- 4c. Press **OK** to confirm you selection.
5. Press **Apply** to confirm the changes, then **OK** to return to the main window.

To revert to default threshold values and to delete custom wavelengths:

1. From the **Main Menu**, select **Setup**, then select the **Thresholds** tab.
2. Press the **Revert to Factory Settings** button.
3. When the application prompts you, confirm the modification with **Yes**.

All threshold values of all wavelengths are returned to their default values, except for thresholds that are associated with custom wavelengths.



IMPORTANT

When you revert thresholds to their default values, custom wavelengths will be deleted from the list of available wavelengths, except if a file using at least one of these wavelengths is still open.

Modifying Trace Analysis Settings

You can view the current trace parameters for the bidirectional measurement as well as for the A->B and B->A traces (see *Trace Info. Tab* on page 212). However, you can only modify the analysis settings for the current A->B and B->A traces, not for the bidirectional measurement.

Two groups of parameters can be changed:

- The fiber settings:
 - **IOR:** Index of refraction of the displayed trace, also known as group index. If you modify this parameter, the distance measurements for the trace will be adjusted. You can enter an IOR value directly or let the application calculate it with the distance between span start and span end you provide.
 - **Backscatter:** Rayleigh backscatter (RBS) coefficient of the displayed trace. If you modify this parameter, the reflectance and ORL measurements for the trace will be adjusted.
 - **Helix factor:** Helix factor setting of the displayed trace. If you modify this parameter, the distance measurements for the trace will be adjusted.

Analyzing Traces with the Bidirectional Analysis Application

Modifying Trace Analysis Settings

- The event detection thresholds:
 - **Splice loss detection threshold:** Splice loss threshold for detecting small non-reflective events during trace analysis.
 - **Reflectance detection threshold:** Reflectance threshold for detecting small reflective events during trace analysis.
 - **End-of-fiber detection threshold:** End-of-fiber threshold for detecting important event loss, which could compromise signal transmission, during trace analysis.

The following table provides the default, minimum and maximum threshold values.

Detection threshold	Default	Minimum	Maximum
Splice loss (dB)	0.020	0.010	5.000
Reflectance (dB)	-72.0	-78.0	-14.0
End-of-fiber (dB)	5.000	1.000	25.000

Note: *The event detection thresholds are not available when you work with a trace in Telcordia (Bellcore) non-EXFO version 200 format.*



IMPORTANT

Modifications to the detection thresholds alter the displayed traces because the application automatically reanalyzes the current trace and regenerates the bidirectional measurement.

All of the modified events will be lost and the events table will be re-created. However, the span start and span end will not be reset in the process.

These detection thresholds will also be used when you reanalyze the traces manually.

Analyzing Traces with the Bidirectional Analysis Application

Modifying Trace Analysis Settings

You can always revert to factory settings. The fiber settings will be reset according to the current trace and the event detection thresholds will return to fixed default values.

To modify the trace analysis settings of the selected trace:

1. From the main window, select the **Trace Info.** tab.
2. Under **Direction**, select either **A->B** or **B->A**.

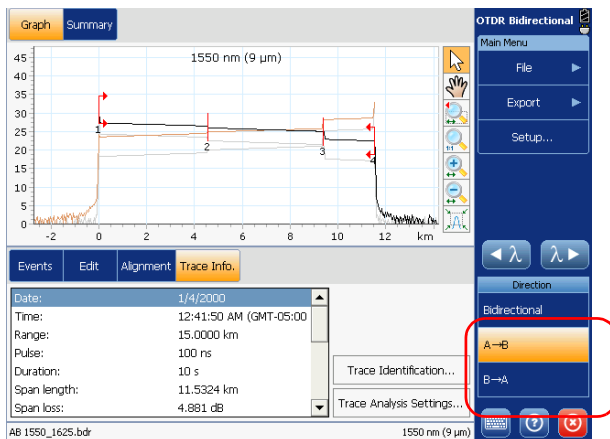

3. Press the **Trace Analysis Settings** button.

Analyzing Traces with the Bidirectional Analysis Application

Modifying Trace Analysis Settings

4. Enter values for the current trace in the appropriate boxes.

A-B Trace Analysis Settings (1550 nm)

Physical fiber characteristics

Fixed IOR
IOR: 1.468325

Fixed length
Length: 1.15324 km

Helix factor: 5.00 %

Backscatter: -81.87 dB

Events detection thresholds

Splice loss detection threshold: 0.020 dB

Reflectance detection threshold: -72.0 dB

End-of-fiber detection threshold: 5.000 dB

Revert to Default Settings

OK Cancel Apply

If you already know the IOR value, select **Fixed IOR**, then enter the value in the corresponding box.

However, if you prefer to let the application calculate the IOR value as function of the distance between span start and span end, select **Fixed length** instead, then enter the distance value.

5. Press **Apply** to confirm the changes.
6. The application may prompt you to confirm whether you want to apply the changes to both unidirectional traces. Select the option that better suits your needs.
7. Press **OK** to return to the **Trace Info.** tab.

Note: *Modifying the current trace parameters affects the trace that is displayed.*

Analyzing Traces with the Bidirectional Analysis Application

Modifying Trace Analysis Settings

To revert to default settings:

- 1.** From the main window, select the **Trace Info.** tab.
- 2.** Under **Direction**, select either **A->B** or **B->A**.
- 3.** Press the **Trace Analysis Settings** button.
- 4.** Press the **Revert to Default Settings** button.
- 5.** When the application prompts you, select **Yes** to complete the operation.
- 6.** Press **Apply** to confirm the changes.
- 7.** The application may prompt you to confirm whether you want to apply the changes to both unidirectional traces. Select the option that better suits your needs.
- 8.** Press **OK** to return to the **Trace Info.** tab.

Saving Traces

After recalling, analyzing and displaying the two traces in the bidirectional table, these traces may be stored as a merged bidirectional file in order to facilitate file management. All information in the tables, comments and reports for A->B, B->A, as well as the bidirectional trace will be saved in the bidirectional file.



IMPORTANT

The application saves the bidirectional file only. Consequently, the changes you make to the unidirectional traces will not be saved to the original files.

When you open a bidirectional file, you will recover all the data of the bidirectional measurement, and the information of the unidirectional traces. However, if you want to modify the unidirectional traces and retrieve their complete data, you can export them from the bidirectional file (see *Exporting Unidirectional Traces from Bidirectional Files* on page 259). You will then be able to use them from the OTDR application.

By default, the suggested file name is based on the file name of the A->B trace. If you prefer, you can modify the file name of the bidirectional file.

It is also possible to modify the path to the bidirectional file, but not the file format (*.bdr* for the bidirectional file).

Note: *The application will keep in memory the path that you use to save your bidirectional measurement file. The next time you want to save a bidirectional file, the application will suggest this path by default.*

Analyzing Traces with the Bidirectional Analysis Application

Saving Traces

To save *bidirectional* files:

1. From the **Main Menu**, select **File > Save**.

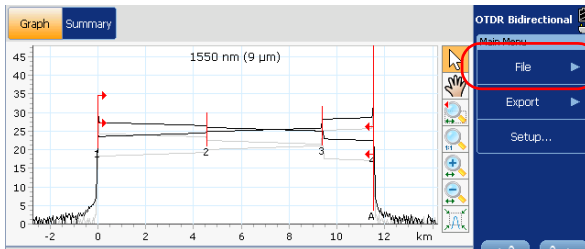

2. From the **Save As** dialog box, select a folder or create one to save your file.
3. If desired, modify the file name.



IMPORTANT

If you specify the name of an existing trace, the original file will be overwritten and only the new file will be available.

4. Press **Save** to confirm.

Exporting Unidirectional Traces from Bidirectional Files

You can export all data from the A->B and B->A traces that were used to generate a specific bidirectional measurement. The files that you export are in native .trc format that can be opened with the OTDR application.

Note: *Traces in Telcordia (Bellcore) EXFO version 200 format, will also be exported to a native .trc format, but operations allowed on them will be limited.*

The exported file will contain all the wavelengths that are available in the bidirectional file. The application names the exported files as follows:

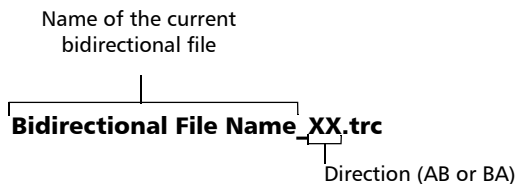

Analyzing Traces with the Bidirectional Analysis Application

Exporting Unidirectional Traces from Bidirectional Files

To export unidirectional traces from a bidirectional file:

1. Create a bidirectional measurement (see *Creating Bidirectional Measurement Files* on page 197).

OR

Open an already existing file (see *Opening Existing Bidirectional Measurement Files* on page 201).
2. From the **Main Menu**, select **Export**.
3. Select either **Export A->B** or **Export B->A**.
4. From the **Save As** dialog box, select a folder or create one to save your file.
5. If desired, modify the file name.



IMPORTANT

If you specify the name of an existing trace file, the original file will be overwritten and only the new file will be available.

6. Press **Save** to confirm.

The exported trace is now available.

Adding Information to the Test Results

You might want to include or update information about the tested fiber and job or add comments to the A->B or B->A traces. This information will be included in the reports that you will create (see *Creating Reports* on page 263). The information you enter is saved along with the bidirectional file only. The original A->B or B->A files will not be modified.

The information that you enter is specific to each wavelength and direction combination (for example, the information for A->B trace at 1550 nm differs from the information for A->B trace at 1625 nm).

The bidirectional measurement uses the information defined for the A->B trace.

To add information to the test results:

1. From the main window, select the **Trace Info.** tab.
2. Under **Direction**, select **A->B** or **B->A**.

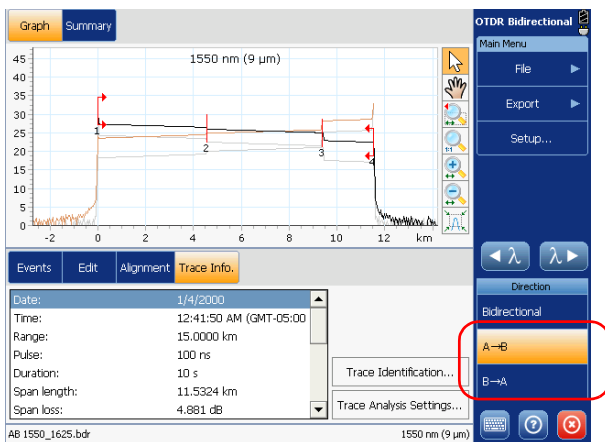

3. Press the **Trace Identification** button.

Analyzing Traces with the Bidirectional Analysis Application

Adding Information to the Test Results

4. Enter the desired information.

A-B Trace Identification (1550 nm)

Trace identification:

Job ID: Job 1

Cable ID: Cable 1

Fiber ID: 0002

Fiber type: My Fiber

Cable manufacturer: Super Cable Manufacturer

Customer: My customer

Company: My company

Location A:

Location: My location

Operator: Operator A

Location B:

Location: My second location

Operator: Operator B

Unit:

Model: FTB-7600E-034B-EA-VFL

Serial number: 393164

Comments:

For maintenance purposes.

Clear All

OK Cancel Apply

Note: The information in the **Model** and **Serial number** boxes is provided by the application and cannot be edited.

5. Press **Apply** to confirm your changes, then **OK** to return to the main window.

The information entered is saved and can be viewed or changed at any time using the same process.

To clear all the information from the Trace Identification window:

1. Press the **Clear All** button.

Note: The information appearing in the **Model** and **Serial number** boxes cannot be deleted.

2. When the application prompts you, confirm the deletion with **Yes**.

3. Press **Apply** to confirm your changes, then **OK** to return to the main window.

Creating Reports

You can create a report directly from the bidirectional application. This report will be saved in .html format. You can open it from your unit or from any computer equipped with a Web browser.

It includes the following information:

- general information such as the cable ID, fiber ID, operators, etc. as defined in the trace identification window (see *Adding Information to the Test Results* on page 261).
- summary results, which comprise global bidirectional status as well as the detailed status for each of the events having a fail status with their wavelength. Fail values are displayed in red.
- results, which comprise test parameters for A->B and B->A traces, bidirectional summary results for events having a fail status, and the bidirectional events table. Fail values are displayed in red.

In the case of multiwavelength files (bidirectional measurement has just been created, but the file has not been saved yet), there will be one section of results per wavelength.

Note: *The reports that you can create with the application do not include graphs. If you want to prepare reports with graphs, you can use the FastReporter application.*

Note: *The application will keep in memory the path that you use to save your report. The next time you want to save a report, the application will suggest this path by default.*

Analyzing Traces with the Bidirectional Analysis Application

Creating Reports

To create a report:

1. Create a bidirectional measurement (see *Creating Bidirectional Measurement Files* on page 197).
OR
Open an already existing file (see *Opening Existing Bidirectional Measurement Files* on page 201).
2. From the **Main Menu**, select **Export > Report**.
3. From the **Save As** dialog box, select a folder or create one to save your file.
4. If desired, modify the file name.



IMPORTANT

If you specify the name of an existing report, the original file will be overwritten and only the new file will be available.

5. Press **Save** to confirm.

To view a report from your unit:

1. Exit the OTDR Bidirectional application.
2. From Compact ToolBox, open File Manager.
3. Go to the folder in which you have saved your report.
4. Select the report you want to view and press the dial located on the front of your unit <image du bouton ENTER>.

OR

Double-tap the report that you want to view.

5. When you have finished, simply close the report.
6. Close File Manager.

16 *Maintenance*

To help ensure long, trouble-free operation:

- Always inspect fiber-optic connectors before using them and clean them if necessary.
- Keep the unit free of dust.
- Clean the unit casing and front panel with a cloth slightly dampened with water.
- Store unit at room temperature in a clean and dry area. Keep the unit out of direct sunlight.
- Avoid high humidity or significant temperature fluctuations.
- Avoid unnecessary shocks and vibrations.
- If any liquids are spilled on or into the unit, turn off the power immediately, disconnect from any external power source, remove the batteries and let the unit dry completely.



WARNING

Use of controls, adjustments, and procedures for operation and maintenance other than those specified herein may result in hazardous radiation exposure.

Cleaning EUI Connectors

Regular cleaning of EUI connectors will help maintain optimum performance. There is no need to disassemble the unit.



IMPORTANT

If any damage occurs to internal connectors, the module casing will have to be opened and a new calibration will be required.

To clean EUI connectors:

1. Remove the EUI from the instrument to expose the connector baseplate and ferrule.

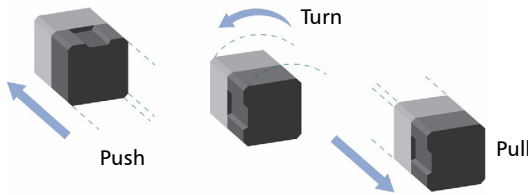

2. Moisten a 2.5 mm cleaning tip with *one drop* of isopropyl alcohol (alcohol may leave traces if used abundantly).
3. Slowly insert the cleaning tip into the EUI adapter until it comes out on the other side (a slow clockwise rotating movement may help).

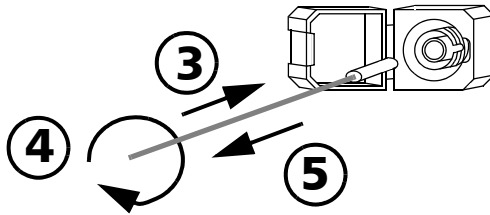

4. Gently turn the cleaning tip one full turn, then continue to turn as you withdraw it.

5. Repeat steps 3 to 4 with a dry cleaning tip.

Note: *Make sure you don't touch the soft end of the cleaning tip.*

6. Clean the ferrule in the connector port as follows:

6a. Deposit *one drop* of isopropyl alcohol on a lint-free wiping cloth.



IMPORTANT

Isopropyl alcohol may leave residues if used abundantly or left to evaporate (about 10 seconds).

Avoid contact between the tip of the bottle and the wiping cloth, and dry the surface quickly.

- 6b.** Gently wipe the connector and ferrule.
- 6c.** With a dry lint-free wiping cloth, gently wipe the same surfaces to ensure that the connector and ferrule are perfectly dry.
- 6d.** Verify connector surface with a portable fiber-optic microscope (for example, EXFO's FOMS) or fiber inspection probe (for example, EXFO's FIP).



WARNING

Verifying the surface of the connector WHILE THE UNIT IS ACTIVE WILL result in permanent eye damage.

7. Put the EUI back onto the instrument (push and turn clockwise).
8. Throw out cleaning tips and wiping cloths after one use.

Verifying Your OTDR

You can perform several tests to ensure your OTDR operates within specifications.

Deviation is measured to determine if the OTDR needs recalibration.

Setting your OTDR to zero can only be done at EXFO. However, you can test your OTDR to verify the accuracy of its measurement origin.

To measure the deviation:

1. Connect at least 2 km of fiber to the OTDR output port.
2. Set the distance range at 2.5 km and acquisition time at 180 seconds.
3. Measure the deviation between a 10 ns pulse and a 30 ns pulse for each laser.

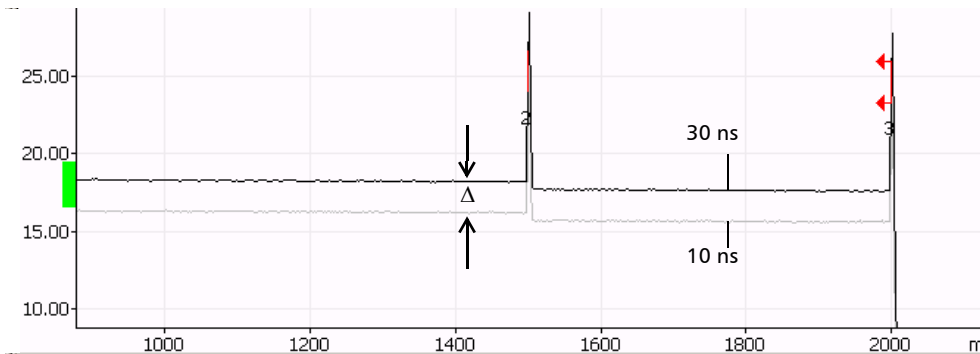

The deviation (Δ) should be between 2.0 dB and 3.0 dB. The deviation must be measured in the linear backscatter region. Do not measure the deviation near distinct reflections.

Performance will be affected if the observed deviation is beyond these limits. The OTDR will eventually require a factory calibration.

Note: *This does not affect the precision of distance or loss measurements.*

To evaluate the launch level:

1. Connect at least 2 km of fiber to the OTDR port.
 - Ensure that the OTDR port and connectors are properly cleaned and that the fiber settings are accurate (IOR, Helix factor and RBS).
 - Do not use a test jumper between the OTDR and the fiber under test to limit the number of connectors.
2. Set the distance range to the fiber length used for the evaluation, the pulse width to the shortest value available, and the acquisition time to 15 seconds.
3. Evaluate the launch level at 0 km by extrapolating the linear region of the curve.

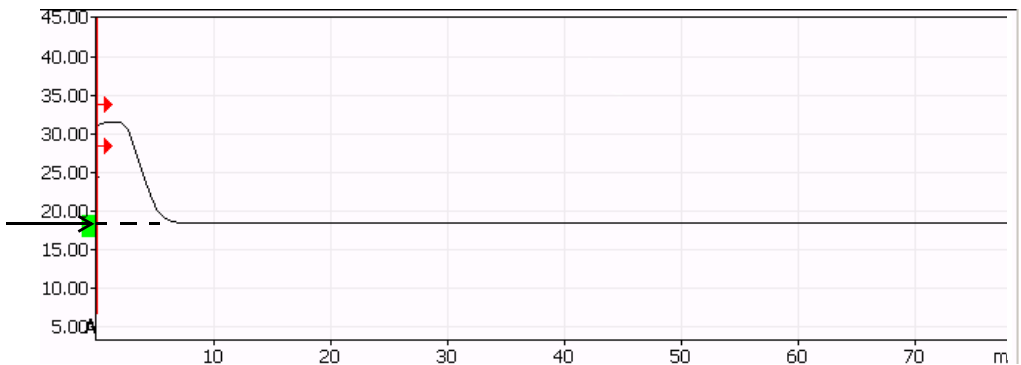

The launch level should be located within the launch window (light green rectangle) appearing on the left side of the Y-axis on the graph. If the launch level is below this window, clean the output connector again, retest the fiber and change the output connector if necessary. If the situation persists, you will observe a degradation in dynamic range. Return the OTDR to EXFO.

Note: *This does not affect the precision of distance or loss measurements.*

Maintenance

Verifying Your OTDR

To verify the OTDR's zero:

1. Connect a patchcord, approximately 10 m long, to the OTDR port. The exact length of the jumper must have been measured mechanically. Ideally, you should use an unjacketed patchcord.
 - ▶ Ensure that the OTDR port and connectors are correctly cleaned.
 - ▶ Ensure that the fiber settings are accurate (IOR, Helix factor and RBS).
2. Set the distance range to less than 2 km, the pulse width to 10 ns and the acquisition time to 30 s.
3. Take a distance measurement, positioning marker A as shown below.

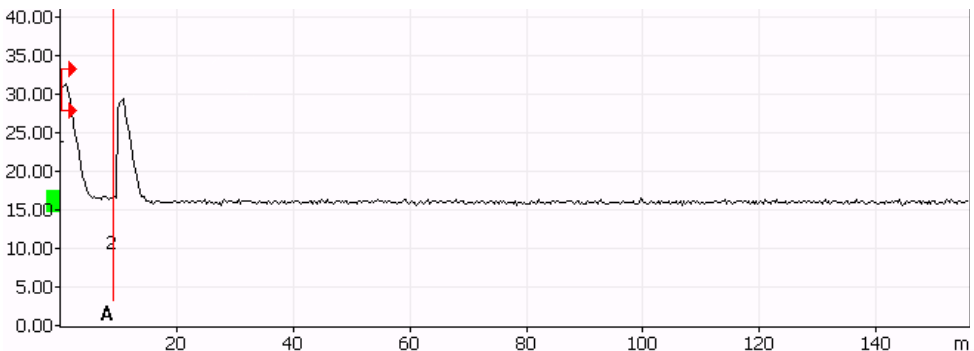

Note: You can also press the **Analyze** button from the **Event** pane. The analysis should return the right position directly.

The position of the marker should be equal to the length of the jumper (± 2 m). For example, 8 to 12 m if the jumper is 10 m long.

If the distance error is beyond this limit, return the OTDR to EXFO.

To measure the event and attenuation dead zones:

1. Connect 2 km of fiber directly to the OTDR port. Use the shortest pulse width and distance range possible.
 - Ensure that the OTDR port and connectors are correctly cleaned.
 - Ensure that the fiber settings are accurate (IOR, Helix factor, and RBS).
2. Measure the length (E) of the first reflection at 1.5 dB from the maximum, as shown below. This is the event dead zone.
3. Measure the distance (A) between the beginning of the reflection and the point where the trace returns to the backscattering level with a 0.5 dB uncertainty, as shown below. Use A and B markers in the **Measure** pane. This is the attenuation dead zone.

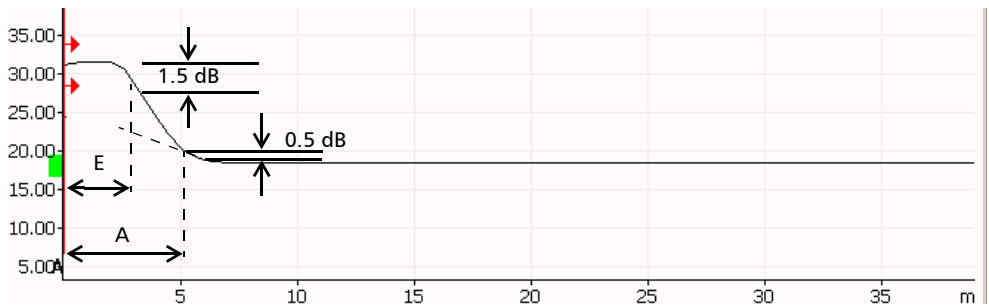

If the results exceed the “maximum permitted specification” (refer to the calibration certificate that came with your product), performance will be affected. A damaged output connector may be the cause.

The reflectance of the output connector should be below -35 dB to attain an adequate dead zone. If reflectance is greater than -35 dB (for example, -20), the incorrect dead zone will be the result of a bad connection. If this is the case, carefully clean the connector. If the problem persists, change the output connector. If the problem remains even after changing the output connector, return the OTDR to EXFO.

Note: *This does not affect the precision of the distance or loss measurements.*

Maintenance

Verifying Your OTDR

To measure the dynamic range:

1. Connect the OTDR as indicated below. Other configurations are possible, such as the one explained in the section on how to determine measurement range, if you use the shortest fiber length from that setup. In all cases, the fiber should have several sections longer than 2 km, with no loss greater than 8 dB and with an average attenuation not exceeding 1 dB/km.

Ensure the OTDR port and connectors are correctly cleaned, and that the fiber settings are accurate (IOR, Helix factor, and RBS).

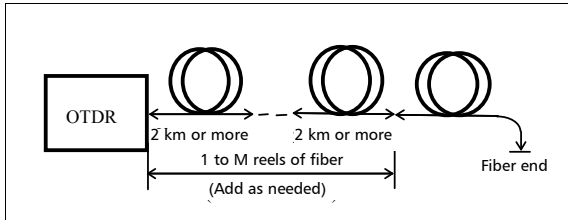

- Set the distance range to 160 km (singlemode fiber), the pulse width to the longest value available and the acquisition time to 180 seconds.

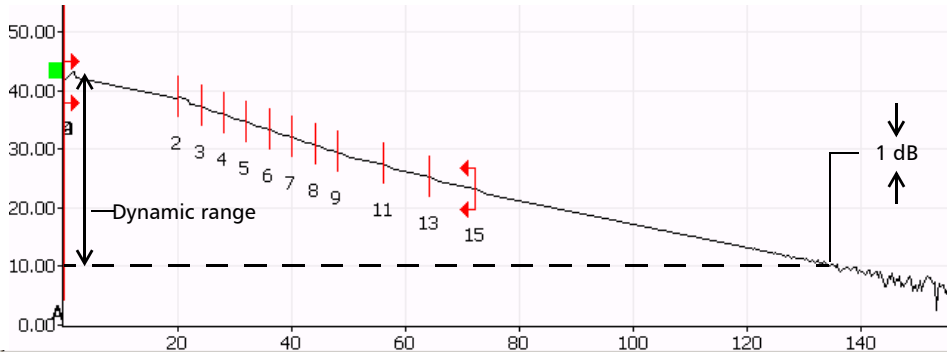

Dynamic range is the difference between the launch level and the position on the curve where the peak-to-peak noise level is 1 dB, plus a correction factor relative to the noise amplitude (which is 5.2 dB).

If the result falls below the “minimum permitted specification” (refer to the calibration certificate that came with your product), you will observe a degradation of performance. It could be caused by a damaged output connector. If this is the case, clean the connector. If the problem persists, change the output connector. If the problem remains even after changing the output connector, return the OTDR to EXFO.

Note: *This does not affect the precision of the distance or loss measurements.*

Maintenance

Verifying Your OTDR

To determine the measurement range (singlemode models only):

1. Connect the OTDR as indicated below. Other configurations are possible, but the fiber should have several sections longer than 2 km, with no loss greater than 8 dB and with the average attenuation not exceeding 1 dB/km. A variable attenuator will be used to adjust the loss in the span.

One or several non-reflective events with a nominal loss of 0.5 dB should be present. Join a series of fiber reels between the OTDR and the variable attenuator for a length of approximately 20 km. Join another series of reels to complete the fiber length needed for the test.

- Ensure that the OTDR port and connectors are correctly cleaned.
- Make sure the fiber settings are accurate (IOR, Helix factor, and RBS).

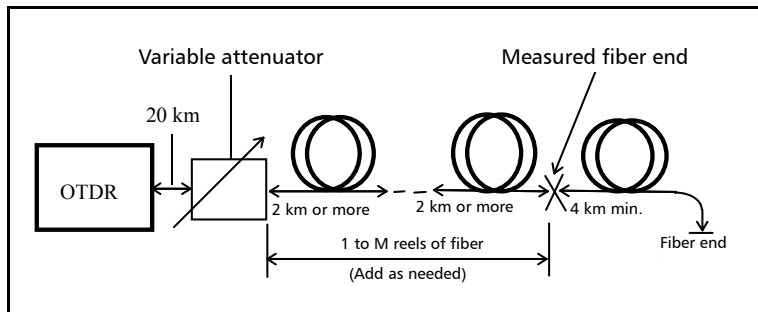

2. Set the distance range to 80 km (singlemode fiber), the pulse width to the longest value available and the acquisition time to 180 seconds.

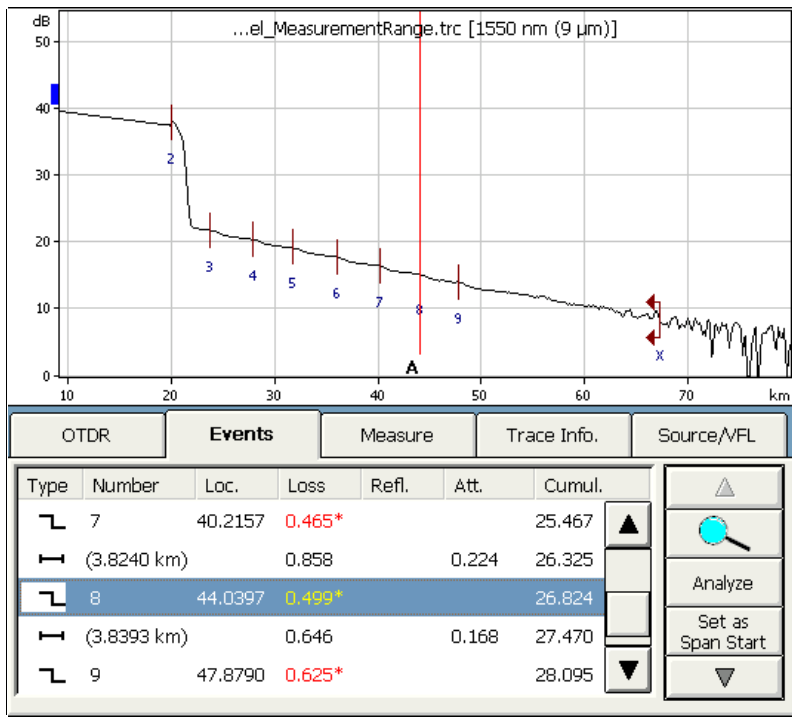

The measurement range using the non-reflective event method represents the amount of attenuation (dB) between the launch level and a 0.5 dB splice (which can be detected and measured to an accuracy of ± 0.1 dB). You can measure it by simply making an acquisition on a fiber with a known attenuation and a known 0.5 dB splice. Attenuation between the splice and the launch level is added until the analysis can no longer measure the splice to within ± 0.1 dB.

Recalibrating the Unit

Manufacturing and service center calibrations are based on the ISO/IEC 17025 Standard, which states that calibration documents must not contain a recommended calibration interval, unless this has been previously agreed upon with the customer.

Validity of specifications depends on operating conditions. For example, the calibration validity period can be longer or shorter depending on the intensity of use, environmental conditions and unit maintenance. You should determine the adequate calibration interval for your unit according to your accuracy requirements.

Under normal use, EXFO recommends calibrating your unit every year.

Recycling and Disposal (Applies to European Union Only)



Recycle or dispose of your product (including electric and electronic accessories) properly, in accordance with local regulations. Do not dispose of it in ordinary garbage receptacles.

This equipment was sold after August 13, 2005 (as identified by the black rectangle).

- Unless otherwise noted in a separate agreement between EXFO and a customer, distributor, or commercial partner, EXFO will cover costs related to the collection, treatment, recovery, and disposal of end-of-lifecycle waste generated by electronic equipment introduced after August 13, 2005 to an European Union member state with legislation regarding Directive 2002/96/EC.
- Except for reasons of safety or environmental benefit, equipment manufactured by EXFO, under its brand name, is generally designed to facilitate dismantling and reclamation.

For complete recycling/disposal procedures and contact information, visit the EXFO Web site at www.exfo.com/recycle.

17 Troubleshooting

Problem	Cause	Solution
The application displays a message indicating that a “Non-resolved fiber end” event has been found.	The fiber under test is too long.	Ensure that the fiber under test is shorter than the maximum length the OTDR can measure.
In multimode fiber testing, launch level remains out of the launch window (light green rectangle) even after cleaning and verifying connection.	Wrong fiber type selected.	<ul style="list-style-type: none"><li data-bbox="787 440 1244 537">▶ If you are testing C fiber, from the Auto or Advanced main window, select MM 50 μm.<li data-bbox="787 545 1244 643">▶ If you are testing D fiber, from the Auto or Advanced main window, select MM 62.5 μm.

Troubleshooting

Problem	Cause	Solution
<p>The application displays a message indicating that a “live fiber error” occurred and the fiber <i>was not</i> connected to the SM Live port.</p>	<p>Light has been detected on the OTDR port during the acquisition or while you were monitoring a fiber in real-time mode.</p>	<p>Disconnect the fiber from the OTDR port. Press OK to close the message. Start another acquisition without any fiber connected to the OTDR. The message about live fiber error should not appear and the OTDR trace should look “normal”.</p> <p>If you still see the message about live fiber error even if no fiber is connected to the OTDR, contact EXFO.</p> <p>Never connect a live fiber to the OTDR port without a proper setup. Any incoming optical power ranging from -65 dBm to -40 dBm will affect the OTDR acquisition. The way the acquisition will be affected depends on the selected pulse width. Any incoming signal greater than -20 dBm could damage your OTDR permanently. For live-fiber testing, refer to the SM Live port specifications for the characteristics of the built-in filter.</p>

Problem	Cause	Solution
<p>The application displays a message indicating that a “live fiber error” occurred and the fiber <i>was</i> connected to the SM Live port.</p>	<p>The level of integrated power in the filter bandwidth of the SM Live port is too high. A transmission wavelength from the network could be too close to the SM Live wavelength.</p>	<p>Disconnect the fiber from the OTDR port. Press OK to close the message. Start another acquisition without any fiber connected to the OTDR. The message about live fiber error should not appear and the OTDR trace should look “normal”.</p> <p>If you still see the message about live fiber error even if no fiber is connected to the OTDR, contact EXFO.</p> <p>Singlemode live-fiber testing requires that the integrated power in the test channel (corresponding to the filter bandwidth of the SM Live port) be as low as possible. Any incoming optical power ranging from -65 dBm to -40 dBm will affect the OTDR acquisition. The way the acquisition will be affected depends on the selected pulse width. Higher power levels will prevent acquisition from running. Verify network compatibility with the SM Live wavelength. Ensure that the network is not transmitting wavelengths greater than 1600 nm.</p>

Troubleshooting

Contacting the Technical Support Group

Contacting the Technical Support Group

To obtain after-sales service or technical support for this product, contact EXFO at one of the following numbers. The Technical Support Group is available to take your calls from Monday to Friday, 8:00 a.m. to 7:00 p.m. (Eastern Time in North America).

For detailed information about technical support, visit the EXFO Web site at www.exfo.com.

Technical Support Group

400 Godin Avenue
Quebec (Quebec) G1M 2K2
CANADA

1 866 683-0155 (USA and Canada)
Tel.: 1 418 683-5498
Fax: 1 418 683-9224
support@exfo.com

To accelerate the process, please have information such as the name and the serial number (see the product identification label), as well as a description of your problem, close at hand.

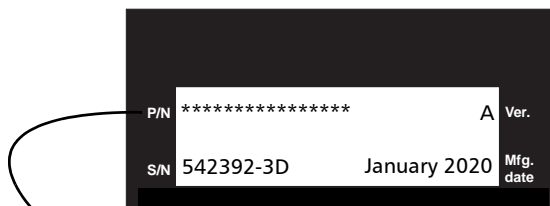

FTB-7200D-XX-XX-XX

FTB-7X00D-XX-XX-XX

FTB-7X00E-XXB-XX-XX

Model

Connector code

Visual fault locator option

Transportation

Maintain a temperature range within specifications when transporting the unit. Transportation damage can occur from improper handling. The following steps are recommended to minimize the possibility of damage:

- Pack the unit in its original packing material when shipping.
- Avoid high humidity or large temperature fluctuations.
- Keep the unit out of direct sunlight.
- Avoid unnecessary shocks and vibrations.

18 Warranty

General Information

EXFO Inc. (EXFO) warrants this equipment against defects in material and workmanship for a period of one year from the date of original shipment. EXFO also warrants that this equipment will meet applicable specifications under normal use.

During the warranty period, EXFO will, at its discretion, repair, replace, or issue credit for any defective product, as well as verify and adjust the product free of charge should the equipment need to be repaired or if the original calibration is erroneous. If the equipment is sent back for verification of calibration during the warranty period and found to meet all published specifications, EXFO will charge standard calibration fees.



IMPORTANT

The warranty can become null and void if:

- unit has been tampered with, repaired, or worked upon by unauthorized individuals or non-EXFO personnel.
- warranty sticker has been removed.
- case screws, other than those specified in this guide, have been removed.
- case has been opened, other than as explained in this guide.
- unit serial number has been altered, erased, or removed.
- unit has been misused, neglected, or damaged by accident.

THIS WARRANTY IS IN LIEU OF ALL OTHER WARRANTIES EXPRESSED, IMPLIED, OR STATUTORY, INCLUDING, BUT NOT LIMITED TO, THE IMPLIED WARRANTIES OF MERCHANTABILITY AND FITNESS FOR A PARTICULAR PURPOSE. IN NO EVENT SHALL EXFO BE LIABLE FOR SPECIAL, INCIDENTAL, OR CONSEQUENTIAL DAMAGES.

Warranty

Liability

Liability

EXFO shall not be liable for damages resulting from the use of the product, nor shall be responsible for any failure in the performance of other items to which the product is connected or the operation of any system of which the product may be a part.

EXFO shall not be liable for damages resulting from improper usage or unauthorized modification of the product, its accompanying accessories and software.

Exclusions

EXFO reserves the right to make changes in the design or construction of any of its products at any time without incurring obligation to make any changes whatsoever on units purchased. Accessories, including but not limited to fuses, pilot lamps, batteries and universal interfaces (EUI) used with EXFO products are not covered by this warranty.

This warranty excludes failure resulting from: improper use or installation, normal wear and tear, accident, abuse, neglect, fire, water, lightning or other acts of nature, causes external to the product or other factors beyond the control of EXFO.



IMPORTANT

EXFO will charge a fee for replacing optical connectors that were damaged due to misuse or bad cleaning.

Certification

EXFO certifies that this equipment met its published specifications at the time of shipment from the factory.

Service and Repairs

EXFO commits to providing product service and repair for five years following the date of purchase.

To send any equipment for service or repair:

- 1.** Call one of EXFO's authorized service centers (see *EXFO Service Centers Worldwide* on page 290). Support personnel will determine if the equipment requires service, repair, or calibration.
- 2.** If equipment must be returned to EXFO or an authorized service center, support personnel will issue a Return Merchandise Authorization (RMA) number and provide an address for return.
- 3.** If possible, back up your data before sending the unit for repair.
- 4.** Pack the equipment in its original shipping material. Be sure to include a statement or report fully detailing the defect and the conditions under which it was observed.
- 5.** Return the equipment, prepaid, to the address given to you by support personnel. Be sure to write the RMA number on the shipping slip. *EXFO will refuse and return any package that does not bear an RMA number.*

Note: *A test setup fee will apply to any returned unit that, after test, is found to meet the applicable specifications.*

After repair, the equipment will be returned with a repair report. If the equipment is not under warranty, you will be invoiced for the cost appearing on this report. EXFO will pay return-to-customer shipping costs for equipment under warranty. Shipping insurance is at your expense.

Routine recalibration is not included in any of the warranty plans. Since calibrations/verifications are not covered by the basic or extended warranties, you may elect to purchase FlexCare Calibration/Verification Packages for a definite period of time. Contact an authorized service center (see *EXFO Service Centers Worldwide* on page 290).

Warranty

EXFO Service Centers Worldwide

EXFO Service Centers Worldwide

If your product requires servicing, contact your nearest authorized service center.

EXFO Headquarters Service Center

400 Godin Avenue
Quebec (Quebec) G1M 2K2
CANADA

1 866 683-0155 (USA and Canada)

Tel.: 1 418 683-5498

Fax: 1 418 683-9224

quebec.service@exfo.com

EXFO Europe Service Center

Omega Enterprise Park, Electron Way
Chandlers Ford, Hampshire S053 4SE
ENGLAND

Tel.: +44 2380 246810

Fax: +44 2380 246801

europe.service@exfo.com

EXFO Telecom Equipment (Shenzhen) Ltd.

3rd Floor, Building 10,
Yu Sheng Industrial Park (Gu Shu
Crossing), No. 467,
National Highway 107,
Xixiang, Bao An District,
Shenzhen, China, 518126

Tel: +86 (755) 2955 3100

Fax: +86 (755) 2955 3101

beijing.service@exfo.com

A Technical Specifications



IMPORTANT

The following technical specifications can change without notice. The information presented in this section is provided as a reference only. To obtain this product's most recent technical specifications, visit the EXFO Web site at www.exfo.com.

SPECIFICATIONS ^a

TECHNICAL SPECIFICATIONS		
	FTB-7200D	FTB-720
Wavelength (nm) ^b	850 ± 20, 1300 ± 20, 1310 ± 20, 1550 ± 20	850 ± 20, 1300 ± 20, 1310 ± 20, 1550 ± 20, 1625 ± 15 (filtered)
Dynamic range (dB) ^{c, d}	27, 26, 36, 34	26, 25, 35, 32, 33
Event dead zone (m) ^e	1	0.8
Attenuation dead zone (m) ^f	3, 4, 4.5, 5	3.5, 4.5, 5, 5, 5
Distance range (km)	Multimode: 0.1, 0.3, 0.5, 1.3, 2.5, 5, 10, 20, 40 Singlemode: 1.25, 2.5, 5, 10, 20, 40, 80, 160, 260	Multimode: 0.1, 0.3, 0.5, 1.3, 2.5, 5, 10, 20, 40 Singlemode: 1.25, 2.5, 5, 10, 20, 40, 80, 160, 260
Pulse width (ns)	Multimode: 5, 10, 30, 100, 275, 1000 Singlemode: 5, 10, 30, 100, 275, 1000, 2500, 10 000, 20 000	Multimode: 5, 10, 30, 50, 100, 275, 500, 1000 Singlemode: 5, 10, 30, 50, 100, 275, 500, 1000, 2500, 10 000, 20 000
Launch conditions ^g	Class CPR 1 or 2	Class CPR 1 or 2 ^h
Linearity (dB/dB)	±0.03	±0.03
Loss threshold (dB)	0.01	0.01
Loss resolution (dB)	0.001	0.001
Sampling resolution (m)	Multimode: 0.04 to 2.5 Singlemode: 0.04 to 5	Multimode: 0.04 to 2.5 Singlemode: 0.04 to 5
Sampling points	Up to 128 000	Up to 256 000
Distance uncertainty (m) ^h	±(0.75 + 0.0025 % x distance + sampling resolution)	±(0.75 + 0.0025 % x distance + sampling resolution)
Measurement time	User-defined (60 min. maximum)	User-defined (60 min. maximum)
Typical real-time refresh (Hz)	3	3
Stable source output power (dBm) ^h	-1.5 (1300 nm), -7 (1550 nm)	-2.5 (1300 nm), -7 (1550 nm)
Visual fault locator (optional) ^b	Laser, 650 nm ± 10 nm CW, P _{out} in 62.5/125 µm: 1.5 dBm (1.4 mW)	N/A

NOTES

- All specifications valid at 23 °C ± 2 °C with an FC/PC connector, unless otherwise specified; APC connector for FTB-720 singlemode model.
- Typical.
- Typical dynamic range with longest pulse and three-minute averaging at SNR = 1.
- Multimode dynamic range is specified for 62.5 µm fiber; a 3 dB reduction is seen when testing 50 µm fiber.
- Typical dead zone for multimode reflectance below -35 dB and singlemode reflectance below -45 dB, using a 5 ns pulse.
- For multimode port, controlled launch conditions allow 50 µm and 62.5 µm multimode fiber testing.
- Does not include uncertainty due to fiber index.
- Typical output power is given at 1300 nm for multimode output and 1550 nm for singlemode output.
- Under improvement to achieve better conditions.

Technical Specifications

All specifications valid at 23° C ± 2° C with an FC/PC connector for the FTB-7300E, with FC/APC for FTB-730, unless otherwise specified.

TECHNICAL SPECIFICATIONS		
Model	FTB-7300E ^a	FTB-730 ^b
Wavelength (nm) ^c	1310 ± 20/1490 ± 10/1550 ± 20/1625 ± 10/1650 ± 7	1310 ± 20/1490 ± 10/1550 ± 20/1625 ± 10
Dynamic range at 20 μs (dB) ^d	39/35/37/39 ^e /37	39/35/37/39
Event dead zone (m) ^f	0.8	0.8
Attenuation dead zone (m) ^f	4/4.5/4.5/4.5/4.5	4/4.5/4.5/4.5
Distance range (km)	1.25, 2.5, 5, 10, 20, 40, 80, 160, 260, 400	1.25, 2.5, 5, 10, 20, 40, 80, 160, 260, 400
Pulse width (ns)	5, 10, 30, 50, 100, 275, 500, 1000, 2500, 10 000, 20 000	5, 10, 30, 50, 100, 275, 500, 1000, 2500, 10 000, 20 000
Linearity (dB/dB) ^c	± 0.03	± 0.03
PON dead zone (m) ^g		35
Loss threshold (dB)	0.01	0.01
Loss resolution (dB)	0.001	0.001
Sampling resolution (m)	0.04 to 5	0.04 to 5
Sampling points	Up to 256 000	Up to 256 000
Distance uncertainty (m) ^h	± (0.75 + 0.001 % x distance + sampling resolution)	± (0.75 + 0.0025 % x distance + resolution)
Measurement time	User-defined (60 min. maximum)	User-defined (60 min. maximum)
Typical real-time refresh (Hz)	4	4
Stable source output power (dBm) ⁱ	-2.5	-2.5
Visual fault locator (optional) ^c	Laser, 650 nm ± 10 nm CW, P _{out} in 62.5/125 μm: 1.5 dBm (1.4 mW)	n/a ^j
Reflectance (dB) ^c	± 2	± 2

For complete details on all available configurations, refer to the Ordering Information section.

Notes

- a. SM Live port built in filter's bandpass 1625 nm ± 15 nm/1650 nm ± 7 nm.
- b. SM Live port built in filter's bandpass 1625 nm ± 15 nm; 1650 nm not available for FTB-730.
- c. Typical.
- d. Typical dynamic range with a three-minute averaging at SNR = 1.
- e. Non-SM Live 1625 nm dynamic range is 37 dB.
- f. Typical dead zone of singlemode modules for reflectance below -45 dB, using a 5 ns pulse.
- g. Non-reflective FUT, non-reflective splitter, 13 dB loss, 50 ns pulse, typical value.
- h. Does not include uncertainty due to fiber index.
- i. Typical output power value at 1550 nm.
- j. Visual fault locator available on FTB-1 platform.

GENERAL SPECIFICATIONS

Module	FTB-7300E	FTB-730
Size (H x W x D)	97 mm x 25 mm x 260 mm (3 13/16 in x 1 in x 10 1/4 in)	130 mm x 36 mm x 252 mm (5 1/8 in x 1 7/16 in x 9 15/16 in)
Weight	0.55 kg (1.2 lb)	0.65 kg (1.4 lb)

All specifications valid at 23 °C ± 2 °C with an FC/PC connector, unless otherwise specified.

TECHNICAL SPECIFICATIONS			
Model ^a	FTB-7400E-XXXX	FTB-7400E-CWS	FTB-7400E-CWCL
Wavelengths (nm) ^b	1310 ± 20/1383 ± 1/1550 ± 20/1625 ± 10	1470 ± 3/1490 ± 3/1510 ± 3/1530 ± 3	1550 ± 3/1570 ± 3/1590 ± 3/1610 ± 3
Dynamic range at 20 μs (dB) ^c	42/40/41/41	41/41/ 41/41	41/41/ 40/40
Event dead zone (m) ^d	0.8	0.8	0.8
Attenuation dead zone (m) ^d	4/4/4.5/4.5	4/4.5/4.5	4/4.5/4.5
Distance range (km)	1.25, 2.5, 5, 10, 20, 40, 80, 160, 260, 400	1.25, 2.5, 5, 10, 20, 40, 80, 160, 260, 400	1.25, 2.5, 5, 10, 20, 40, 80, 160, 260, 400
Pulse width (ns)	5, 10, 30, 100, 275, 1000, 2500, 10 000, 20 000	5, 10, 30, 100, 275, 1000, 2500, 10 000, 20 000	5, 10, 30, 100, 275, 1000, 2500, 10 000, 20 000
Linearity (dB/dB) ^b	± 0.03	± 0.03	± 0.03
Loss threshold (dB)	0.01	0.01	0.01
Loss resolution (dB)	0.001	0.001	0.001
Sampling resolution (m)	0.04 to 5	0.04 to 5	0.04 to 5
Sampling points	Up to 256 000	Up to 256 000	Up to 256 000
Distance uncertainty (m) ^e	± (0.75 + 0.001 % x distance + sampling resolution)	± (0.75 + 0.001 % x distance + sampling resolution)	± (0.75 + 0.001 % x distance + sampling resolution)
Measurement time	User-defined (5 sec. minimum to 60 min. maximum)	User-defined (5 sec. minimum to 60 min. maximum)	User-defined (5 sec. minimum to 60 min. maximum)
Typical real-time refresh (Hz)	4	4	4
Stable source output power (dBm) ^f	-4.5 (7400E-0023B)		
Visual fault locator (optional) ^b	Laser, 650 nm ± 10 nm CW, P _{out} in 62.5/125 μm: 1.5 dBm (1.4 mW)		

Notes

- For complete details on all available configurations, refer to the Ordering Information section.
- Typical.
- Typical dynamic range with a three-minute averaging at SNR = 1.
- Typical dead zone of singlemode modules for reflectance below -45 dB, using a 5 ns pulse.
- Does not include uncertainty due to fiber index.
- Typical output power value at 1550 nm.

Technical Specifications

All specifications valid at 23 °C ± 2 °C with an FC/PC connector, unless otherwise specified.

TECHNICAL SPECIFICATIONS	
Model ^a	FTB-7500E
Wavelengths (nm) ^b	1310 ± 20/1550 ± 20/1625 ± 10
Dynamic range at 20 μs (dB) ^c	45/45/45
Event dead zone (m) ^d	0.8
Attenuation dead zone (m) ^d	4/4.5/4.5
Distance range (km)	1.25, 2.5, 5, 10, 20, 40, 80, 160, 260, 400
Pulse width (ns)	5, 10, 30, 50, 100, 275, 500, 1000, 2500, 10 000, 20 000
Linearity (dB/dB) ^b	± 0.03
Loss threshold (dB)	0.01
Loss resolution (dB)	0.001
Sampling resolution (m)	0.04 to 5
Sampling points	Up to 256 000
Distance uncertainty (m) ^e	± (0.75 + 0.001 % x distance + sampling resolution)
Measurement time	User-defined (5 sec. minimum to 60 min. maximum)
Typical real-time refresh (Hz)	4
Stable source output power (dBm) ^f	-1 (7400E-0023B)
Visual fault locator (optional) ^b	Laser, 650 nm ± 10 nm CW, P _{out} In 62.5/125 μm: 1.5 dBm (1.4 mW)

Notes

- a. For complete details on all available configurations, refer to the Ordering Information section.
- b. Typical.
- c. Typical dynamic range with a three-minute averaging at SNR = 1. Typical dynamic range at 1550 nm for the FTB-7500E-0023B configuration is 2 dB lower.
- d. Typical dead zone of singlemode modules for reflectance below -45 dB, using a 5 ns pulse.
- e. Does not include uncertainty due to fiber index.
- f. Typical output power value at 1550 nm.

All specifications valid at 23 °C ± 2 °C with an FC/PC connector, unless otherwise specified.

TECHNICAL SPECIFICATIONS	
Model ^a	FTB-7600E
Wavelengths (nm) ^b	1310 ± 20/1550 ± 20/1625 ± 10
Dynamic range at 20 μs (dB) ^c	50/50/48 ^g
Event dead zone (m) ^d	1/1.5/1
Attenuation dead zone (m) ^d	5/5/5
Distance range (km)	1.25, 2.5, 5, 10, 20, 40, 80, 160, 260, 400
Pulse width (ns)	5, 10, 30, 100, 275, 1000, 2500, 10 000, 20 000
Linearity (dB/dB) ^b	± 0.03
Loss threshold (dB)	0.01
Loss resolution (dB)	0.001
Sampling resolution (m)	0.04 to 5
Sampling points	Up to 256 000
Distance uncertainty (m) ^e	± (0.75 + 0.001 % x distance + sampling resolution)
Measurement time	User-defined (5 sec. minimum to 60 min. maximum)
Typical real-time refresh (Hz)	4
Stable source output power (dBm) ^f	5
Visual fault locator (optional) ^b	Laser, 650 nm ± 10 nm CW, P _{out} in 62.5/125 μm: 1.5 dBm (1.4 mW)

Notes

- a. For complete details on all available configurations, refer to the Ordering Information section.
- b. Typical.
- c. Typical dynamic range with a three-minute averaging at SNR = 1.
- d. Typical dead zone of singlemode modules for reflectance below -45 dB, using a 5 ns pulse.
- e. Does not include uncertainty due to fiber index.
- f. Typical output power value at 1550 nm.
- g. With NZDS fiber (G.655).

B *Description of Event Types*

This section describes all types of events that may appear in the events table generated by the application. Here is a guide to the descriptions:

- Each type of event has its own symbol.
- Each type of event is represented by a graph of a fiber trace, which illustrates the power reflected back toward the source as a function of distance.
- An arrow points to the location of the event type in the trace.
- Most graphs show one complete trace; that is, an entire acquisition range.
- Some graphs show only a portion of the entire range to view events of interest more closely.

Description of Event Types

Span Start

Span Start

The Span Start of a trace is the event that marks the beginning of the fiber span. By default, the Span Start is placed on the first event of a tested fiber (typically the first connector of the OTDR itself).

You can make another event the start of the span you want to focus your analysis on. This will set the beginning of the events table at a specific event along the trace.

Span End

The Span End of a trace is the event that marks the end of the fiber span. By default, the Span End is placed on the last event of a tested fiber, and is called the end-of-fiber event.

You can also make another event the end of the span you want to focus your analysis on. This will set the end of the events table at a specific event along the trace.

Short Fibers

You can test short fibers with the application. You can even define a fiber span for short fibers by placing the span start and the span end on the same event.

Continuous Fiber ----

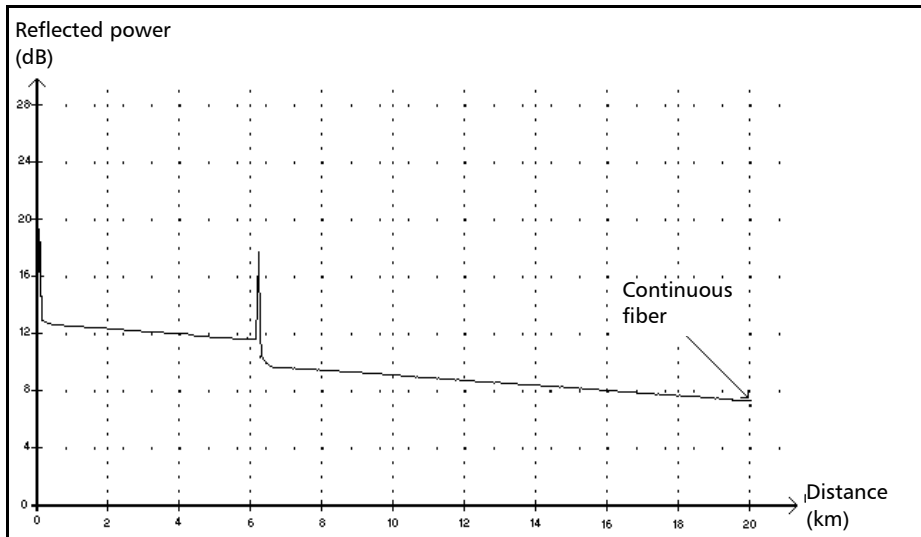

This event indicates that the selected acquisition range was shorter than the fiber length.

- The fiber end was not detected because the analysis process ended before reaching the end of the fiber.
- The acquisition distance range should therefore be increased to a value greater than the fiber length.
- There is no loss or reflectance specified for continuous fiber events.

Description of Event Types

End of Analysis

End of Analysis →

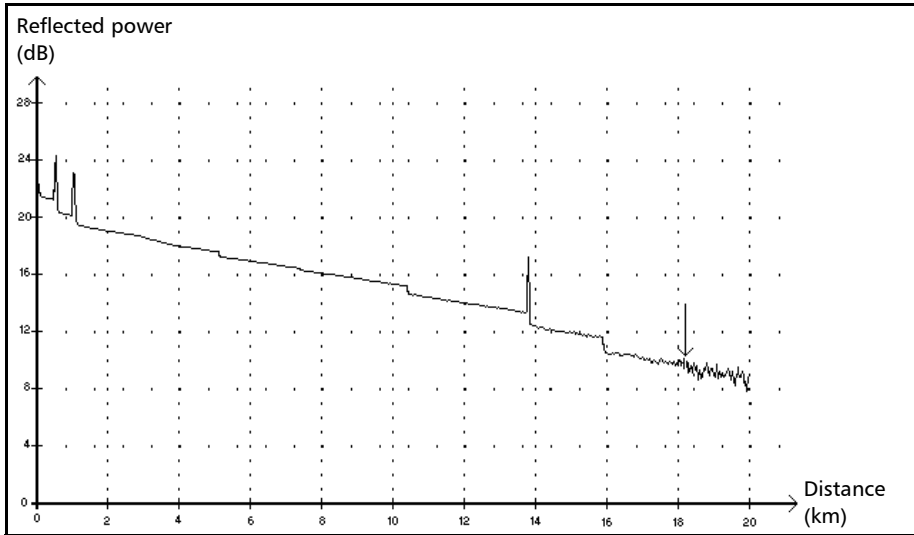

This event indicates that the pulse width used did not provide enough dynamic range to get to the end of the fiber.

- The analysis ended before reaching the end of the fiber because the signal-to-noise ratio was too low.
- The pulse width should therefore be increased so the signal reaches the end of the fiber with a sufficient signal-to-noise ratio.
- There is no loss or reflectance specified for end-of-analysis events.

Non-Reflective Event

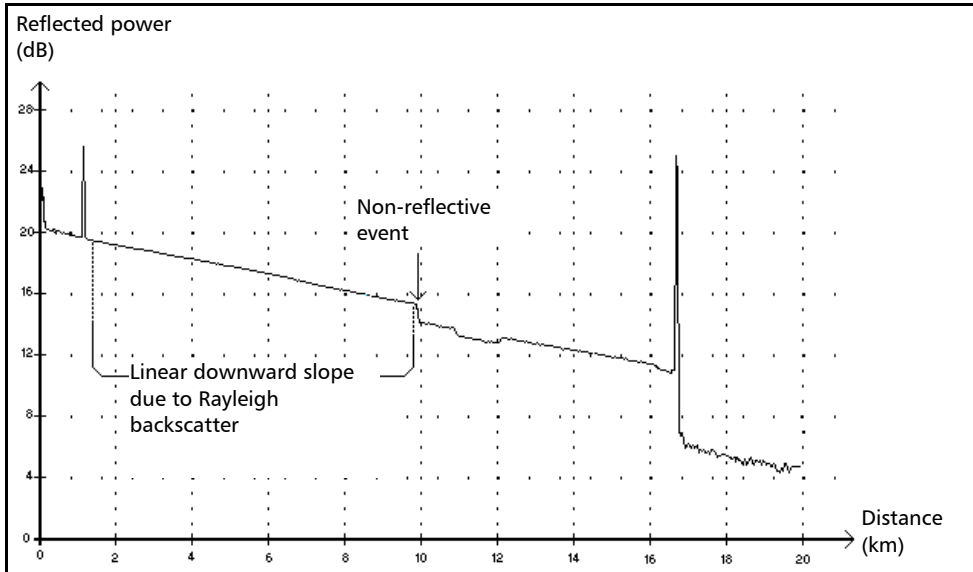

This event is characterized by a sudden decrease in the Rayleigh backscatter signal level. It appears as a discontinuity in the downward slope of the trace signal.

- This event is often caused by splices, macrobends, or microbends in the fiber.
- A loss value is specified for non-reflective events. There is no reflectance specified for this type of event.
- If you set thresholds, the application indicates a non-reflective fault in the events table, whenever a value exceeds the loss threshold (see *Setting Pass/Fail Thresholds* on page 53).

Description of Event Types

Reflective Event

Reflective Event ▮

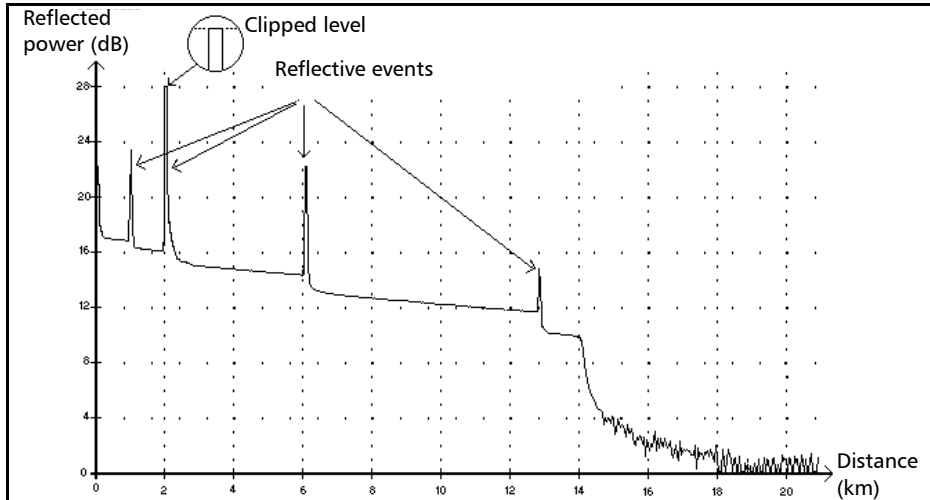

Reflective events appear as spikes in the fiber trace. They are caused by an abrupt discontinuity in the index of refraction.

- Reflective events cause a significant portion of the energy initially launched into the fiber to be reflected back toward the source.
- Reflective events may indicate the presence of connectors, mechanical splices, or even poor-quality fusion splices or cracks.
- Normally, loss and reflectance values are specified for reflective events.
- When the reflective spike reaches the maximum level, its top may be clipped due to the saturation of the detector. As a result, the dead zone (minimum distance for making a detection or attenuation measurement between this event and a second nearby) may be increased.
- If you set thresholds, the application indicates a reflective fault in the events table, whenever a value exceeds reflectance or connector loss thresholds (see *Setting Pass/Fail Thresholds* on page 53).

Positive Event

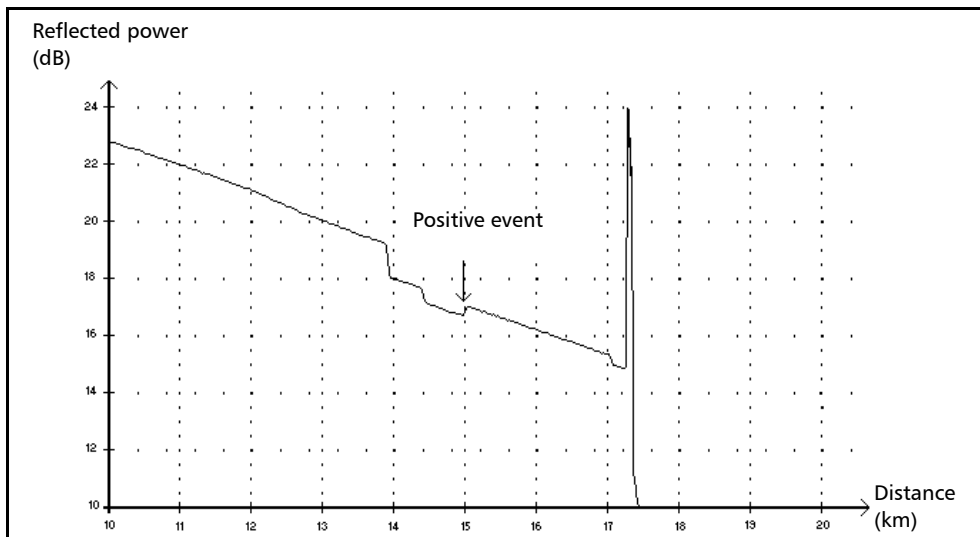

This event indicates a splice with an apparent gain, due to the junction of two fiber sections having different fiber backscatter characteristics (backscatter and backscatter capture coefficients).

- A loss value is specified for positive events. The loss specified does not indicate the true loss of the event.
- The true loss has to be measured by performing bidirectional fiber measurements and bidirectional analysis.

Description of Event Types

Launch Level

Launch Level →

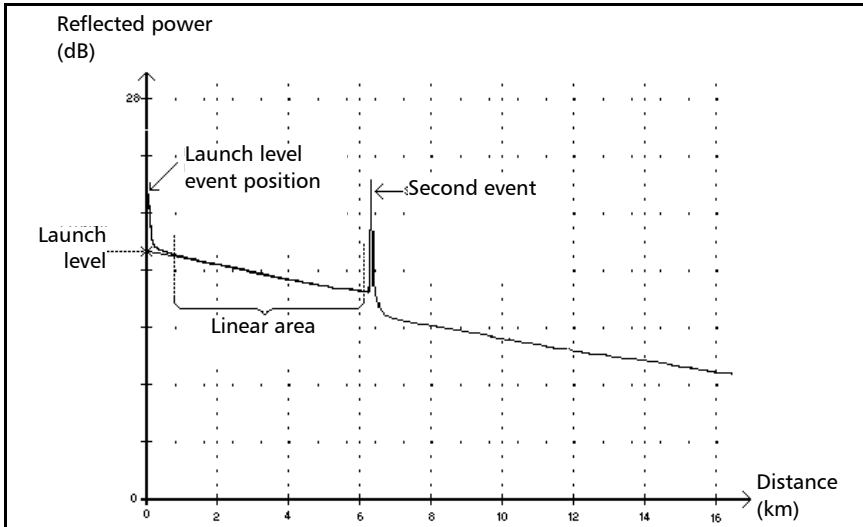

This event indicates the level of the signal launched into the fiber.

- The figure above shows how the launch level is measured.

A straight line is plotted using least-square approximation to fit all trace points in the linear area between the first and second detected events.

The straight line is projected toward the Y-axis (dB) until it crosses the axis.

The crossing point indicates the launch level.

- <<<< in the events table indicates that the launch level is too low.

Fiber Section

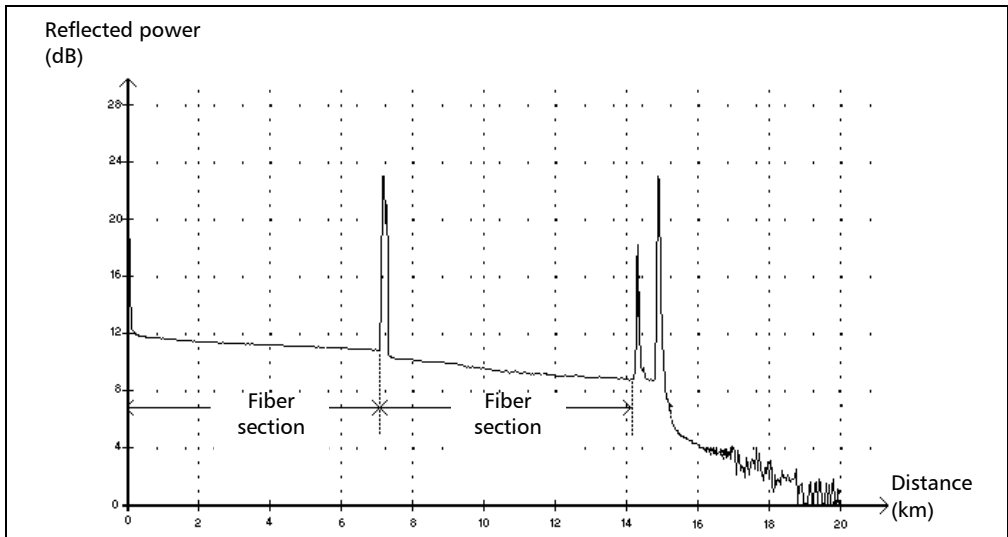

This symbol denotes a fiber section with no event.

- The sum of all fiber sections contained in an entire fiber trace equals the total fiber length. Detected events are distinct even if they cover more than one point on the trace.
- A loss value is specified for fiber section events. No reflectance is specified for this type of event.
- The attenuation (dB/distance in kilometers) is obtained by dividing the loss by the fiber section length.

Description of Event Types

Merged Event

Merged Event Σ

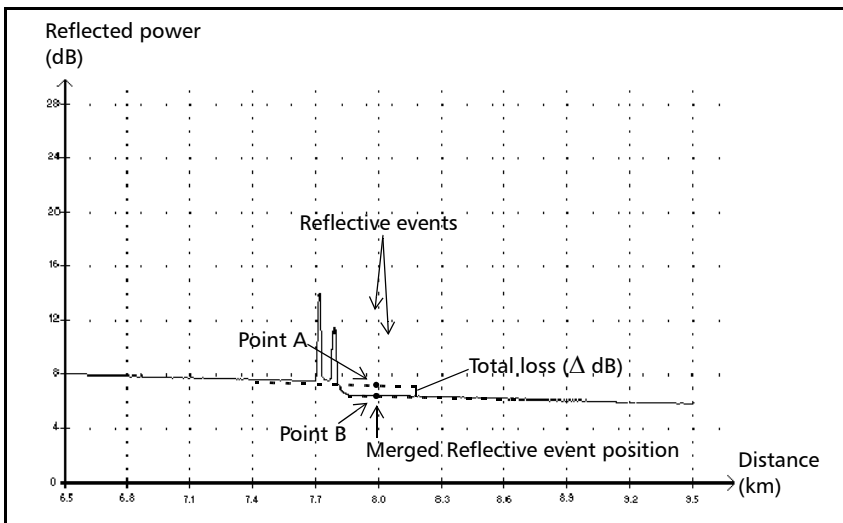

This symbol denotes an event combined with one or more other events. It also indicates the total loss produced by the merged events following it in the events table.

- A Merged Event is composed of subevents. Only the Merged Event is displayed in the events table, not the subevents composing it.
- *Reflective* events may indicate the presence of connectors, mechanical splices, or poor-quality fusion splices or cracks.
- *Non-reflective* events may indicate the presence of splices, splitters or bendings.
- A reflectance value is specified for all merged events and indicates the maximum reflectance for the merged event. A reflectance value is also displayed for each reflective subevent composing the Merged Event.

- The total loss (Δ dB) produced by the events is measured by plotting two straight lines.
 - The first line is plotted by fitting, through least-square approximation, trace points in the linear area preceding the first event.
 - The second line is plotted by fitting, through least-square approximation, trace points in the linear area following the second event. If there were more than two merged events, this line would be plotted in the linear area following the last merged event. This line is then projected toward the first merged event.
 - The total loss (Δ dB) equals the power difference between the point where the first event begins (point A) and the point on the projected straight line located just below the first event (point B).
 - No loss value can be specified for the subevents.

Description of Event Types

Merged Event

Pass/Fail Tests

As an example about pass/fail tests, let us consider the situation below:

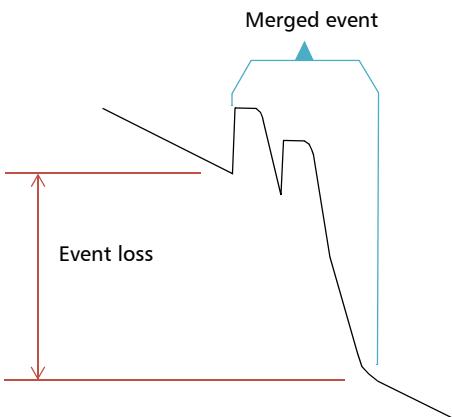

Merged sub-events:

2 reflective losses
1 non-reflective loss

Thresholds:

Reflective loss: 0.5 dB
Non-reflective Loss: 0.2 dB

For a merged event, it is possible to determine the global event loss, but not the contribution of each sub-event. This is why the pass/fail test may sometimes lead to “false positive” or “false negative” results.

When evaluating event status against thresholds, we are faced with two possible conditions:

- All event types are tested (reflective, non-reflective)
- Only some event types are selected (for example, you could decide not to test reflective loss)

The third case would be to test none of the event types, which means the same as not wanting to know the status of the events.

All Event Types Are Tested

In the first case, where all event types are tested, the pass/fail conditions are as follows:

- If the event loss is less than or equal to the smallest threshold value, then the event status is *Pass*.
- If the event loss is greater than the sum of the number of sub-events of a type, multiplied by the threshold value for this event type, then the event status is *Fail*.
- If the event loss is “in between”, since it is not possible to know exactly the weight of a sub-event in the merged event, the global event is considered to have a status of *Pass*.

Pass/Fail Analysis

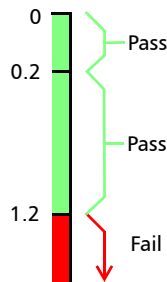

Fail Level

$$\begin{aligned}
 &= \sum(N_{\text{sub}} \times Th_{\text{sub}}) \\
 &= (2 \times 0.5) + (1 \times 0.2) \\
 &= 1.2
 \end{aligned}$$

If the merged event loss is smaller than or equal to 1.2, then the status is *Pass*. Otherwise, it is *Fail*.

Description of Event Types

Merged Event

Not All Event Types Are Tested

In this situation, the only thing that we can clearly know is when the loss has a *Pass* status. If the global event loss is less than or equal to the smallest threshold value (a value that is tested, of course), we are sure that the merged event status is *Pass*. Otherwise, we cannot know, so the status of the event is *Unknown*.

In our example, if we suppose that the you chose not to test non-reflective losses, then the analysis would be done as shown below:

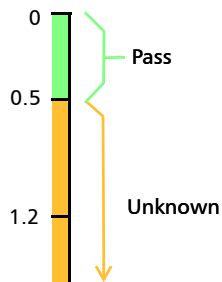

Effect of Event Status in the Global Trace Status

- A trace status is, by default, set to *Unknown*.
- If a trace is set to *Fail* once, it remains with that status (it cannot be set back to *Pass* or *Unknown*).
- Whenever an event status is *Fail*, so is the trace status.
- If an event status is *Pass*, the trace status can change from *Unknown* to *Pass*.
- If an event status is *Unknown*, the trace status remains the same. In other words, the event, in this case, has no influence on the trace status.

To avoid *Unknown* statuses, do not unselect loss thresholds individually.

Description of Event Types

Echo

Echo Π_{nr}

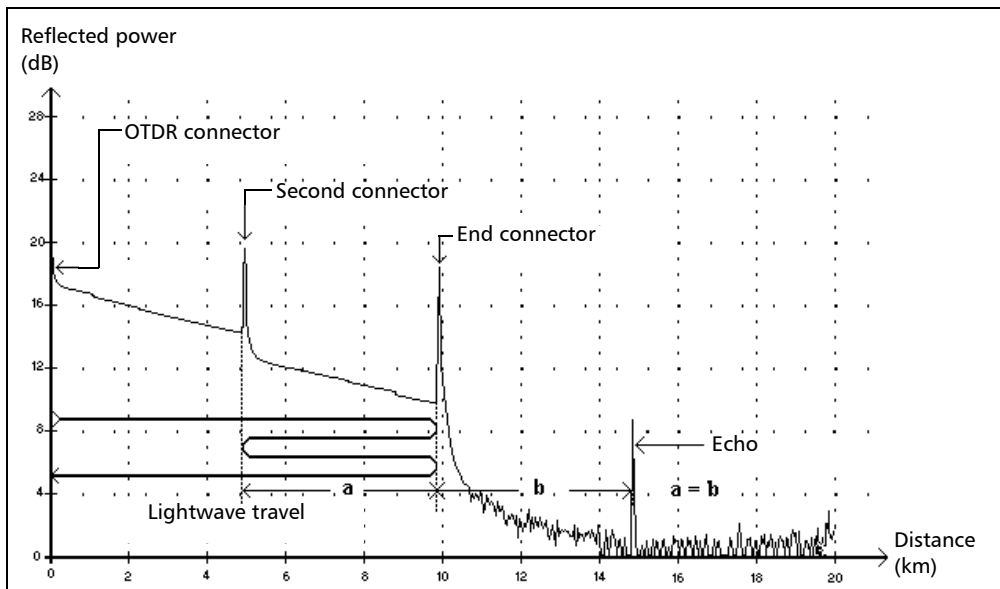

This symbol indicates that a reflective event has been detected after the end of the fiber.

- In the example above, the launched pulse travels up to the end connector and is reflected back toward the OTDR. Then, it reaches the second connector and is reflected again toward the end connector. It is then reflected back to the OTDR.
- The application interprets this new reflection as an echo because of its characteristics (reflectance and particular position with respect to other reflections).
- The distance between the second connector reflection and the end connector reflection is equal to the distance between the end connector reflection and the echo.
- There is no loss specified for echo events.

Reflective Event (Possible Echo)

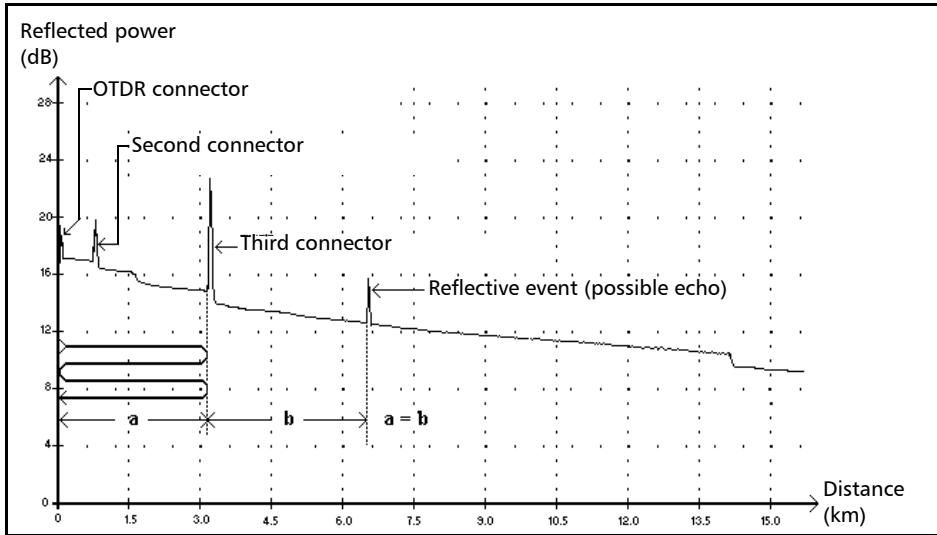

This symbol indicates a reflective event that can be a real reflection or an echo produced by another stronger reflection located closer to the source.

- In the example above, the launched pulse hits the third connector, is reflected back to the OTDR and reflected again into the fiber. It then reaches the third connector a second time and is reflected once more to the OTDR.

The application would therefore detect a reflective event located at twice the distance of the third connector. Since this event is almost null (no loss), and since its distance is a multiple of the third connector distance, The application would interpret it as a possible echo.

- A reflectance value is specified for reflective events (possible echo).

Index

- **** indication 174
- A**
- accessing source 189
- accuracy, trace 49
- acquiring traces
- Advanced mode 37, 100
 - Auto mode 35
 - Fault finder mode 75
 - Template mode 66
- acquisition
- automatic, in Advanced mode 37
 - Advanced mode 37
 - Auto mode 33
 - changing resolution 45
 - custom time values 100
 - date 182, 183
 - duration 134, 213
 - interrupting 33, 38
 - pulse width used 134
 - setting analysis detection
 - thresholds 148
 - Template mode 61, 66
 - time, autorange 42
 - wavelength used 134
- Advanced mode
- acquiring traces 37
 - acquisition-specific fiber parameters ... 133
 - setting the autorange
 - acquisition time 42
 - testing 37
- after-sales service 284
- analysis
- after acquisition 51, 151, 215
 - fiber span 153, 217
 - thresholds, detection... 135, 148, 214, 253
 - thresholds, pass/fail 53, 247
- analyzing a trace. *see* analysis, after acquisition
- analyzing traces 154
- application, main window 196
- application, starting 19
- Att. column in events table 114, 209, 210
- attenuation
- fiber section 53, 247
 - fiber-section threshold 53, 247
 - LSA measurement method 172
 - measurement 172
 - reflectance 174
 - two-point measurement method 172
- Auto mode
- acquiring traces 35
 - selecting test wavelength 33, 37
 - setting fiber parameters 36
 - testing 33
- automatic acquisition time. *see* autorange acquisition time
- automatic zoom reset 122
- autonaming, OTDR 24, 78
- autorange acquisition time 42
- average loss in events table 209
- average loss in Trace Info. tab 134, 213
- average splice loss
- in Trace Info. tab 134, 213
- B**
- basic OTDR theory 8
- bidirectional analysis
- acquisition-specific fiber parameters... 252
 - general description 193
 - opening multiwavelength trace file 197
 - opening single-wavelength trace file ... 197
 - purpose 193
 - restrictions 193, 197
 - starting 195

Index

bidirectional trace
 file content 257
 saving 257
buttons, trace editing in events table 115
buttons, zoom. see controls, zoom

C

calibration
 certificate 278
 interval 278
caution
 of personal hazard 10
 of product hazard 10
certification information viii
cleaning
 EUI connectors 268
 fiber ends 22
 front panel 267
clearing traces from the display (OTDR) 132
color of traces in display 107
comments about events, inserting 244
connector loss, threshold 53, 247
connector, threshold loss 53, 247
connectors, cleaning 268
controls, zoom 123, 221
conventions, safety 10
Create Ref./Template OTDR. see Template mode
Cumul. column in events table.. 114, 209, 210
cumulative loss 114, 209, 210
customer service 289

D

data points 49
date of trace acquisition 182, 183
decrementation, file name 24, 78
default trace name 24, 78
definition of the OTDR 1
deleting events 144, 235
delimiting fiber span 128, 243
description of event types 297
detecting module 16

detection, reflective events 154
dial
 Distance 45
 moving 47
 Pulse 45
 Time 45
disappearing marker 165
displaying
 fiber sections 128, 243
 fiber span 122
 injection level in events table 128, 244
 merged events 244
 pass/fail messages 55
 traces 130
distance
 between events 166
 equation 8
 range 45

E

end-of-fiber
 detection threshold 135, 148, 214, 253
 event 298
equation of distance 8
equipment returns 289
EUI
 baseplate 21
 connector adapter 21
 dust cap 21
EUI connectors, cleaning 268
event
 comments, inserting 244
 deleting 144, 235
 description of types 297
 difference with fault 8
 distance measurement 166
 effect of setting
 as span start/end 58, 153, 220
 fault notification 248
 insertion 142, 227
 location 113, 115, 211

loss. *see* event loss
 name, displaying 113, 208
 non-reflective, averaged loss 134, 213
 number..... 113, 209, 210
 position 209, 210
 reflectance 114, 210
 threshold, pass/fail..... 53, 247
 thresholds, pass/fail message..... 248
 unchangeable 138, 231
 undeletable..... 144, 235
 event average loss, in events table 209
 event loss
 average, in Trace Info. tab 134, 213
 in events table 113, 210
 in Trace Info. tab 213
 measurement..... 167
 total, in Trace Info. tab 134
 event types
 description..... 297
 continuous fiber 299
 echo..... 312
 end of analysis..... 300
 end-of-fiber 298
 fiber section..... 305
 launch level..... 304
 merged event 306
 non-reflective event 301
 positive event 303
 reflective event 302
 reflective event (possible echo) 313
 short fiber..... 298
 span end..... 298
 span start 298
 events table
 description..... 205
 locating event..... 115, 211
 trace editing buttons 115
 events, view 108
 EXFO universal interface. *see* EUI

F

Fault finder mode, acquiring traces 75
 Fault Finder, testing..... 75
 fault notification, for events 248
 fiber
 attenuation 114, 209, 210
 identifying by name 24, 78, 181
 identifying visually 189
 section attenuation 53, 247
 sections display 128, 243
 span length..... 134
 type in Trace Info. tab 134
 see also fiber span 58
 fiber ends, cleaning 22
 fiber parameters, setting 133
 fiber parameters, setting default values 43
 fiber section attenuation threshold 53, 247
 fiber settings, acquisition-specific
 (Bidirectional) 252
 fiber span
 analysis 153, 217
 average loss in Trace Info. tab..... 134
 average splice loss
 in Trace Info. tab 134, 213
 delimitation 128, 243
 length in Trace Info. tab..... 58, 134, 213
 setting 58
 span loss in Trace Info. tab 134, 213
 zooming (automatic) 122
 file name, in trace display..... 88, 126
 first connector check 28, 85
 forced selection of test wavelength..... 36, 40
 four-point measurement method vs. LSA .. 167
 Fresnel reflection 9
 front panel, cleaning 267

G

General tab..... 88, 126, 241
 generating reports..... 184
 graph view 205
 grid display..... 88, 126, 241

Index

H

helix factor
admissible values 43
in Trace Info. tab 135, 214, 252
modification 133, 252
setting 43
hiding traces 130
high-resolution feature 49

I

identification label 284
identifying fiber under test 189
incrementation, file name 24, 78
injection level, in events table 128, 244
injection level, too low 28, 85
inserting a module 13
IOR
in Trace Info. tab 135, 214, 252
modification 133, 252
obtaining 43
setting 43

L

label, identification 284
laser safety information 11, 12
laser, using OTDR as source 189
launch level 271
least-square approximation. *see* LSA
level of injection, warning 28, 85
linear view 108
Loc. in events table 113
locating events 115, 211
location of event 209, 210
loss
average for fiber span 134
average splice 134, 213
connector 53, 247
connector, threshold 53, 247
cumulative for fiber span 134, 213
in events table 113, 210

measurement 167
measurement, positioning markers 171
modification 138, 231
non-reflective events average 134, 213
span threshold 53, 247
splice 53, 247
splice, threshold 53, 247
LSA measurement method
definition 172
vs. four-point 167
vs. two-point 172

M

macrobends, viewing 111
maintenance
EUI connectors 268
front panel 267
general information 267
marker
disappearing on zoom 165
location calculation 139
too close to one another 165
measurement
attenuation (two-point and LSA) 172
event distance 166
event loss 167
event RBS level 166
ORL 175
units 90, 96
merged events 244
module
detection 16
insertion 13
removal 13
mounting EUI connector adapter 21
multiwavelength trace color in display 107
multiwavelength trace file
bidirectional analysis 197
displaying 130

N

- naming trace automatically 24, 78
- native trace format 178
- noise area, searching 154
- non-reflective event, averaged loss ... 134, 213
- number
 - in events table 113, 209, 210
 - of the event 113, 209, 210

O

- opening
 - a single-wavelength trace file 197
 - multiwavelength trace file 197
- opening trace file 159
- operating light source 189
- optical return loss. *see* ORL
- ORL threshold 53, 247
- ORL, module required for calculations 175
- OTDR
 - basic theory 8
 - definition 1
 - file compatibility between versions 178
 - internal components 9
 - using as laser source 189
- OTDR software
 - launch level 271

P

- parameters
 - Advanced mode 42
 - helix factor 43
 - IOR 43
 - Rayleigh backscatter coefficient 43
 - Template mode 62
 - trace display 88, 126, 241
- pass/fail 110, 111, 206
- pass/fail message display 55

- pass/fail test
 - disabling 54, 248
 - enabling 54, 248
 - when to perform 54
- photodetector 8
- Pos. in event table 209, 210
- position, event 209, 210
- precision, trace 49
- printing reports 184
- product
 - identification label 284
 - specifications 291
- pulse
 - dial 45
 - in Trace Info. tab 134
 - setting width 45
 - width unit 240
- pulse/time in Trace Info. tab 213

R

- RBS (Rayleigh backscatter)
 - description 9
 - in Trace Info. tab 135, 214, 252
 - modification 133, 252
 - obtaining 43
 - setting 43
- RBS level measurement event 166
- re-analyzing a trace 151, 215
- recalibration 278
- reference trace
 - parameters 62
 - selection 74
- Refl. column in events table 114, 210
- reflectance
 - attenuation 174
 - detection threshold 135, 148, 214, 253
 - modification 138, 231
 - of event 114, 210
 - of non-reflective events 174
 - source of inaccurate measurements 44
 - threshold 53, 247

Index

reflective ends of fiber..... 154
reflective events, detecting..... 154
removing a module..... 13
report
 content..... 184
 of trace..... 181
 printing..... 183
resetting fiber parameters, Auto mode..... 36
restrictions Ref. Creation/Template mode.... 62
restrictions, bidirectional
 analysis utility..... 193, 197
return merchandise authorization (RMA) .. 289

S

safety
 caution..... 10
 conventions..... 10
 warning..... 10
same pulse and time for all wavelengths 46
saving
 bidirectional traces..... 257
 format, native..... 178
saving traces in different formats..... 177
section length..... 209, 210
selecting
 Automatic OTDR test wavelength 33, 37
 reference trace..... 74
 test wavelength, automatically..... 36, 40
 wavelength in Auto mode..... 33, 37
service and repairs..... 289
service centers..... 290
setting
 fiber span..... 58
 pass/fail thresholds..... 53, 247
shipping to EXFO..... 289
signal-to-noise ratio..... 46
single-wavelength trace file, bidir. analysis 197
software. see application
source
 accessing..... 189
 operating..... 189

source see *also* laser
source, function overview..... 189
span
 length threshold..... 53, 247
 loss threshold..... 53, 247
span end
 description..... 298
 effect of setting
 on events table..... 58, 153, 220
 setting in memory..... 246
span position, updating..... 153, 217
span start
 description..... 298
 effect of setting
 on events table..... 58, 153, 220
 setting in memory..... 246
specifications, product..... 291
splice loss
 average, in Trace Info. tab..... 134, 213
 detection threshold..... 135, 148, 214, 253
 threshold..... 53, 247
stopping trace acquisition..... 33, 38
storage requirements..... 267
storing
 changing default trace name..... 24, 78
 trace autonaming..... 24, 78
summary table..... 110, 111, 206
swapping traces..... 158
symbols, safety..... 10

T

technical specifications..... 291
technical support..... 284
temperature for storage..... 267
Template mode
 acquiring the reference trace..... 64
 acquiring traces..... 66
 applying parameters to other traces..... 62
 description..... 61
 restrictions..... 62
 selecting reference trace..... 74

- setting parameters..... 62
 - test settings used..... 62
 - testing 61
- Template OTDR. *see* Template mode
- test wavelength, forced selection..... 36, 40
- test, settings used in Template mode..... 62
- testing
 - Advanced mode..... 37
 - Auto mode 33
 - Fault Finder..... 75
 - Template mode..... 61
- theory, OTDR..... 8
- thresholds
 - analysis detection 148
 - connector loss 53, 247
 - detection 214, 253
 - end-of-fiber detection 148, 253
 - fault notification..... 248
 - fiber section attenuation 53, 247
 - fiber-section attenuation 53, 247
 - ORL..... 53, 247
 - pass, fail, warning 55
 - pass/fail message..... 248
 - reflectance..... 53, 247
 - reflectance detection ... 135, 148, 214, 253
 - setting pass/fail..... 53–54, 247–248
 - span length 53, 247
 - span loss..... 53, 247
 - splice loss 53, 247
 - splice loss detection..... 135, 148, 214, 253
 - trace analysis 53, 247
- Time dial
 - custom-time mode 100
 - setting 45
- time in Trace Info. tab..... 134, 213
- time, custom values 100
- timer 20
- total loss in Trace Info. tab..... 134
- touchscreen keyboard, activating..... 87, 102
- trace
 - accuracy..... 49
 - acquisition in Advanced mode..... 37
 - acquisition in Auto mode..... 35
 - acquisition in Fault finder mode 75
 - acquisition in Template mode..... 66
 - analysis 151, 215
 - analysis detection thresholds 148, 253
 - autonaming 24, 78
 - changing default name..... 24, 78
 - color in trace display..... 107
 - compatibility between
 - ToolBox versions 178
 - editing buttons 115
 - export formats 177
 - opening file..... 159
 - pass/fail analysis threshold..... 53, 247
 - purpose of swapping 158
 - re-analyzing 151, 215
 - stopping the acquisition 33, 38
 - storage, in different formats..... 177
 - swapping 158
- trace display
 - behavior on zoom..... 123
 - clearing traces..... 132
 - description 205
 - displaying file name 88, 126
 - mode, complete trace..... 241
 - mode, markers..... 241
 - mode, optimum..... 241
 - parameters..... 88, 126, 241
- trace formats 177
- trace formats, native 178
- Trace Info. tab
 - average loss 134
 - average splice loss..... 134, 213
 - Backscatter..... 214, 252
 - backscatter 135
 - displaying traces 130
 - end-of-fiber threshold..... 135, 214, 253
 - fiber type used..... 134
 - helix factor..... 135, 214, 252
 - hiding traces 130
 - IOR..... 135, 214, 252
 - length 213

Index

pulse..... 134
reflectance threshold..... 135, 214, 253
span length 134
splice loss threshold..... 135, 214, 253
time..... 134, 213
total loss..... 134
total/average loss..... 213
wavelength..... 134
trace report
 creating 181
 printing 183
transportation requirements 267, 285
two-point
 attenuation..... 172
 measurement method vs. LSA 172
 measurement method, definition 172
type
 in events table 113, 209, 210
 of event 113, 209, 210

U

unchangeable events 138, 231
undeletable events 144, 235
unit recalibration..... 278
UPC connectors, detecting 154
updating span position 153, 217
using light source..... 189

V

VFL
 1 Hz pulsed output..... 192
 continuous wave output..... 192
 using 189
view
 graph..... 205
 linear 108
 summary..... 110, 111, 206
visual fault locator. see VFL

W

warning thresholds..... 55
warranty
 certification..... 288
 exclusions 288
 general..... 287
 liability..... 288
 null and void..... 287
wavelength
 indication in Trace Info. tab 134
 selecting, in Auto mode 33, 37

Z

zoom
 controls..... 123, 221
 resetting automatically 122
 window display..... 126

NOTICE 通告

CHINESE REGULATION ON RESTRICTION OF HAZARDOUS SUBSTANCES 中国关于有害物质限制的规定



NAMES AND CONTENTS OF THE TOXIC OR HAZARDOUS SUBSTANCES OR ELEMENTS
CONTAINED IN THIS EXFO PRODUCT
包含在本 **EXFO** 产品中的有毒有害物质或元素的名称和含量

O	Indicates that this toxic or hazardous substance contained in all of the homogeneous materials for this part is below the limit requirement in SJ/T11363-2006 表示该有毒有害物质在该部件所有均质材料中的含量均在 SJ/T11363-2006 标准规定的限量要求以下。
X	Indicates that this toxic or hazardous substance contained in at least one of the homogeneous materials used for this part is above the limit requirement in SJ/T11363-2006 表示该有毒有害物质至少在该部件的某一均质材料中的含量超出 SJ/T11363-2006 标准规定的限量要求。

Part Name 部件名称	Toxic or hazardous Substances and Elements 有毒有害物质和元素					
	Lead 铅 (Pb)	Mercury 汞 (Hg)	Cadmium 镉 (Cd)	Hexavalent Chromium 六价铬 (Cr VI)	Polybrominated biphenyls 多溴联苯 (PBB)	Polybrominated diphenyl ethers 多溴二苯醚 (PBDE)
Enclosure 外壳	O	O	O	O	O	O
Electronic and electrical sub-assembly 电子和电子组件	X	O	X	O	X	X
Optical sub-assembly ^a 光学组件 ^a	X	O	O	O	O	O
Mechanical sub-assembly ^a 机械组件 ^a	O	O	O	O	O	O

a. If applicable.
如果适用。

MARKING REQUIREMENTS
标注要求

Product 产品	Environmental protection use period (years) 环境保护使用期限 (年)	Logo 标志
This Exfo product 本 EXFO 产品	10	
Battery ^a 电池 ^a	5	

- a. If applicable.
如果适用。

P/N: 1060559

www.EXFO.com · info@exfo.com

CORPORATE HEADQUARTERS	400 Godin Avenue	Quebec (Quebec) G1M 2K2 CANADA Tel.: 1 418 683-0211 · Fax: 1 418 683-2170
EXFO AMERICA	3701 Plano Parkway, Suite 160	Plano TX, 75075 USA Tel.: 1 972 907-1505 · Fax: 1 972 836-0164
EXFO EUROPE	Omega Enterprise Park, Electron Way	Chandlers Ford, Hampshire S053 4SE ENGLAND Tel.: +44 2380 246810 · Fax: +44 2380 246801
EXFO ASIA-PACIFIC	151 Chin Swee Road #03-29, Manhattan House	SINGAPORE 169876 Tel.: +65 6333 8241 · Fax: +65 6333 8242
EXFO CHINA	Room 2711, Trade Center, No. 4028 Jintian Road, Futian District Beijing Global Trade Center, Tower C, Room 1207, 36 North Third Ring Road East, Dongcheng District	Shenzhen 518035 P. R. CHINA Tel.: +86 (755) 8203 2300 · Fax: +86 (755) 8203 2306 Beijing 100013 P. R. CHINA Tel.: +86 (10) 5825 7755 · Fax: +86 (10) 5825 7722
EXFO SERVICE ASSURANCE	270 Billerica Road	Chelmsford MA, 01824 USA Tel.: 1 978 367-5600 · Fax: 1 978 367-5700
TOLL-FREE	(USA and Canada)	1 800 663-3936

© 2011 EXFO Inc. All rights reserved.
Printed in Canada (2011-02)

