

TERRIGENA FURNITURE PROVENCE RANGE

price list 2020



Terrigena Furniture
tel: 01604 696030
Rural Shopping Yard
Castle Ashby, Northants. NN7 1LF

www.terrigenafurniture.co.uk

PRICELIST | Provence/New Edition



Choose H-legs w/outcut, straight legs or X-legs and table top w or w/o fillings

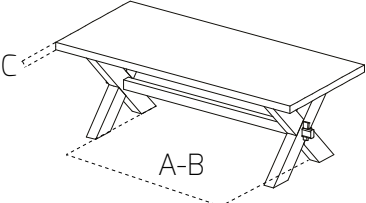
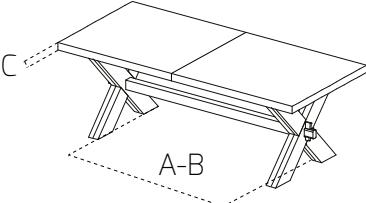
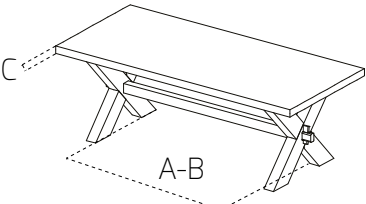

PRICELIST | dining table w/X-legs

description + drawings	dimension (cm)				solid oak		oak w/fillings	
	L	W	H	A-B	item no.	price	item no.	price
TOP PLATE 40 MM								
 <p>Dining table in oak w/undivided top plate. X-legs. C = 4 cm.</p>	140	80	75	84	4271	1451	3271	1451
	160	90	75	104	4272	1516	3272	1516
	180	90	75	124	4273	1584	3273	1584
	200	100	75	144	4274	1676	3274	1676
	220	100	75	164	4275	1770	3275	1770
	240	100	75	184	4276	1874	3276	1874
	260	100	75	204	4277	1977	3277	1977
 <p>Dining table in oak w/middle extension. Double legs. X-legs. C = 4 cm.</p>	180	90	75	118	4273M	2139	3273M	2139
	220	100	75	158	4274M	2445	3275M	2445
Leaf for tables w/middle extension.	45	90			4270M-90	326	3270M-90	326
	45	100			4270M-100	344	3270M-100	344
Leaf for tables w/undivided top plate.	50	80			4270-80	256	3270-80	256
	50	90			4270-90	263	3270-90	263
	50	100			4270-100	283	3270-100	283
TOP PLATE 60 MM								
 <p>Dining table in oak w/undivided top plate. X-legs. C = 6 cm.</p>	140	80	74	84	4281	1878	3281	1878
	160	90	74	104	4282	1962	3282	1962
	180	90	74	124	4283	2045	3283	2045
	200	100	74	144	4284	2126	3284	2126
	220	100	74	164	4285	2209	3285	2209
	240	100	74	184	4286	2288	3286	2288
	260	100	74	204	4287	2367	3287	2367
Leaf for tables w/undivided top plate.	50	80			4280-80	276	3280-80	276
	50	90			4280-90	283	3280-90	283
	50	100			4280-100	303	3280-100	303

■ for 1-3 leaves ■ for 1-4 leaves

Remember to tell:



C04 / C06 / C11 / C12 ..

AP / RL / SC / UP

PRICELIST | dining table w/straight legs

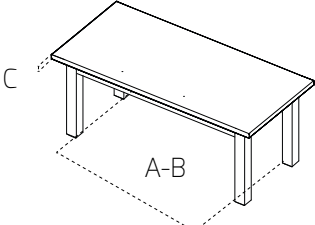
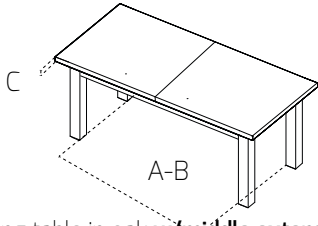
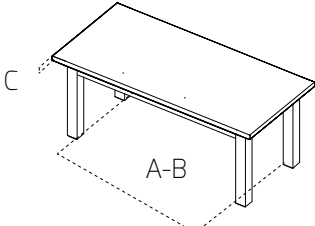
description + drawing	dimension (cm)				solid oak		oak w/fillings	
	L	B	H	A-B	item no.	price	item no.	price
TOP PLATE 40 MM								
 <p>Dining table in oak w/undivided top plate. Straight legs. C = 4 cm.</p>	140	80	75	104	4471	1368	3471	1368
	160	90	75	124	4472	1451	3472	1451
	180	90	75	144	4473	1534	3473	1534
	200	100	75	164	4474	1624	3474	1624
	220	100	75	184	4475	1714	3475	1714
	240	100	75	204	4476	1806	3476	1806
	260	100	75	224	4477	1896	3477	1896
 <p>Dining table in oak w/middle extension for 2 leaves. Straight legs. C = 4 cm.</p>	180	90	77	144	4473M	1608	3473M	1608
	220	100	77	184	4475M	1818	3475M	1818
Leaf for tables w/middle extension.	45	90			4470M-90	310	3470M-90	310
	45	100			4470M-100	315	3470M-100	315
Leaf for tables w/undivided top plate.	50	80			4470-80	256	3470-80	256
	50	90			4470-90	263	3470-90	263
	50	100			4470-100	283	3470-100	283
TOP PLATE 60 MM								
 <p>Dining table in oak w/undivided top plate. Straight legs. C = 6 cm.</p>	140	80	77	104	4481	1797	3481	1797
	160	90	77	124	4482	1896	3482	1896
	180	90	77	144	4483	1995	3483	1995
	200	100	77	164	4484	2074	3484	2074
	220	100	77	184	4485	2155	3485	2155
	240	100	77	204	4486	2220	3486	2220
	260	100	77	224	4487	2286	3487	2286
Leaf for tables w/undivided top plate.	50	80			4480-80	276	3480-80	276
	50	90			4480-90	283	3480-90	283
	50	100			4480-100	306	3480-100	306

Remember to tell:



ITEM NO.



COLOUR

C04 / C06 / C11 / C12 ..



FINISH

AP / RL / SC / UP

PRICELIST | dining table w/H-legs

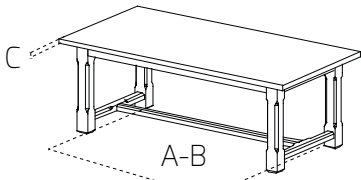
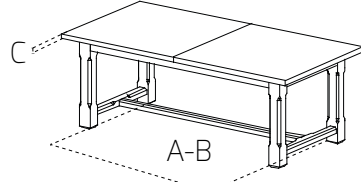
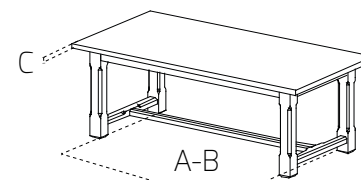
description + drawing	dimension (cm)				solid oak		oak w/fillings	
	L	W	H	A-B	item no.	price	item no.	price
TOP PLATE 40 MM								
 <p>Dining table in oak w/undivided top plate. H-legs. C = 4 cm.</p>	140	80	75	104	4171	1451	3171	1451
	160	90	75	124	4172	1516	3172	1516
	180	90	75	144	4173	1584	3173	1584
	200	100	75	164	4174	1676	3174	1676
	220	100	75	184	4175	1770	3175	1770
	240	100	75	204	4176	1874	3176	1874
	260	100	75	224	4177	1977	3177	1977
 <p>Dining table in oak w/middle extension for 2 leaves. H-legs. C = 4 cm.</p>	180	90	77	144	4173M	1689	3173M	1689
	220	100	77	184	4175M	1908	3175M	1908
Leaf for tables w/middle extension.	45	90			4170M-90	310	3170M-90	310
	45	100			4170M-100	326	3170M-100	326
Leaf for tables w/undivided top plate.	50	80			4170-80	256	3170-80	256
	50	90			4170-90	263	3170-90	263
	50	100			4170-100	283	3170-100	283
TOP PLATE 60 MM								
 <p>Dining table in oak w/undivided top plate. H-legs. C = 6 cm.</p>	140	80	77	104	4181	1878	3181	1878
	160	90	77	124	4182	1962	3182	1962
	180	90	77	144	4183	2045	3183	2045
	200	100	77	164	4184	2126	3184	2126
	220	100	77	184	4185	2209	3185	2209
	240	100	77	204	4186	2288	3186	2288
	260	100	77	224	4187	2367	3187	2367
Leaf for tables w/undivided top plate.	50	80			4180-80	276	3180-80	276
	50	90			4180-90	283	3180-90	283
	50	100			4180-100	306	3180-100	306

Remember to tell:



ITEM NO.



COLOUR

C04 / C06 / C11 / C12 ..



FINISH

AP / RL / SC / UP

PRICELIST | benches

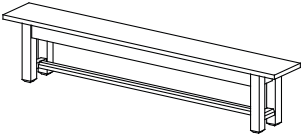
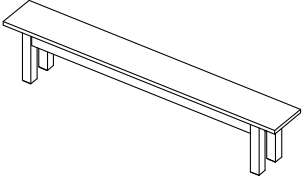
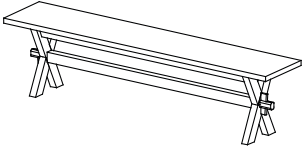

description + drawing	dimension (cm)			solid oak	
	L	W	H	item no.	price
 Bench in oak. H-legs. Top plate = 4 cm.	140	30	45	3321	488
	180	30	45	3323	540
	220	30	45	3325	582
 Bench in oak. Straight legs. Top plate = 4 cm.	140	30	45	4321	463
	180	30	45	4323	513
	220	30	45	4325	553
 Bench in oak. X-legs. Top plate = 4 cm.	140	30	45	3217	237
	180	30	45	3218	594
	220	30	45	3219	641

Remember to tell:



C04 / C06 / C11 / C12 ..

AP / RL / SC / UP

PRICELIST | coffee tables

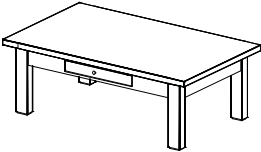
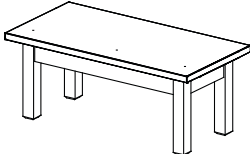
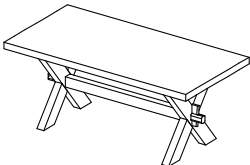

description + drawing	dimension (cm)			solid oak		oak w/fillings	
	L	W	H	item no.	price	item no.	price
 Coffee table in oak w/drawer. Straight legs. Top plate = 4 cm.	140	85	50	4241	1311	3241	1311
 Coffee table in oak. Straight legs. Top plate = 4 cm.	110	110	50	4244	1311	3244	1311
	120	60	50	4243	1030	3243	1030
 Coffee table in oak. X-legs. Top plate = 4 cm.	140	85	50	4231	1311	3231	1311
	110	110	50	4232	1311	3232	1311
	120	60	50	4233	1030	3233	1030





Remember to tell:

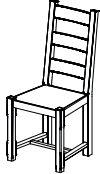
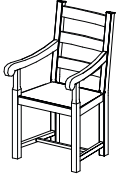
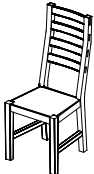

C04 / C06 / C11 / C12 ..

AP / RL / SC / UP

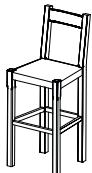
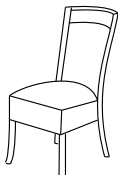
PRICELIST | chairs

description + drawing	dimension (cm)			item no.	seat	price
	W	H	SH			
Dining chair w/H-legs and outcut. 	45	104	45	3340	rush	288
					leather	366
				3342	wood	288
Dining chair w/armrest, H-legs and outcut. 	58	104	45	3341	rush	472
					leather	553
				3343	wood	472
Dining chair w/straight legs 	45	104	45	1294	rush	362
					leather	441
					wood	362
Dining chair w/armrest and straight legs 	58	104	45	1295	rush	528
					leather	594
					wood	528
Bar stool w/outcut. 	45	114	74	3381	rush	423
					leather	474
				3382	wood	423
Wicker chair. 		98	45	1640	cotton	364
Wicker chair w/armrest. 		98	45	1641	cotton	434
Wicker chair w/armrest. 		98	45	1645	cotton	279

Remember to tell:









C04 / C06 / C11 / C12 ..

AP / RL / SC / UP

PRICELIST | consoll

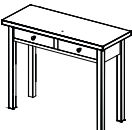
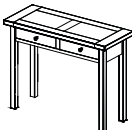

description + drawing		dimension (cm)			solid oak		oak w/fillings	
solid oak	oak w/fillings	W	D	H	item no.	price	item no.	price
		60	60	56	4246	468	3246	468
		70	50	85	4420	749	3420	749
		123	50	85	4421	983	3421	982
		123	50	85	4445	909	3445	909

Remember to tell:



ITEM NO.



COLOUR

C04 / C06 / C11 / C12 ..



FINISH

AP / RL / SC / UP

PRICELIST | sideboards



Provence style sideboard 3538.

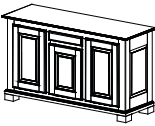
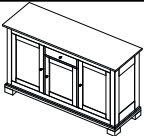
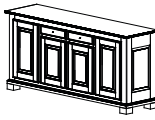
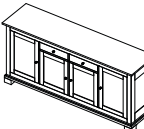
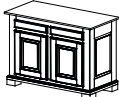
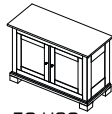
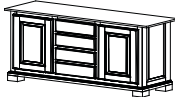
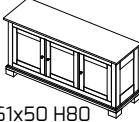

New Edition style sideboard 4535.

description + drawing		dimension (cm)			Provence style		New Edition style	
Provence style	New Edition style	W	D	H	item no.	price	item no.	price
		160	54	96	3535	2245	4535	2133
		207	54	96	3538	3143	4538	2985
 114x54 H95	 113x50 H80	113/114	54/50	95/80	3543	1919	4543	1725
 160x50 H82	 161x50 H80	160/161	50	82/80	3545	2502	4545	2002

Remember to tell:



ITEM NO.



COLOUR

C04 / C06 / C11 / C12 ..



FINISH

AP / RL / SC / UP

PRICELIST | cabinets



Provence style cabinet 3566.



New Edition style cabinet 4588.

description + drawing		dimension (cm)			Provence style		New Edition style	
Provence stil	New Edition stil	W	D	H	item no.	price	item no.	price
		70	70	200	3580	2549	4580	2421
		120	46	200	3581	2619	4581	2619
With drawer! 55x40 H185	 69x46 H200	55/69	40/46	185/200	3566	2103	4588	2013
		112	40	200	3587	1401	4587	1401

Remember to tell:



C04 / C06 / C11 / C12 ..

AP / RL / SC / UP

WOOD COLOURS



OAK C3
Lacquered

We treated this wood with lacque.

C3 are only made for products without patination.

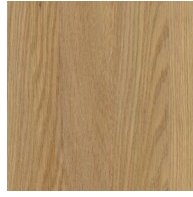

OAK C4
Natural oiled

We treated this wood with our 'Natural oil'.

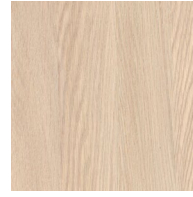

OAK C6
White oiled

We treated this wood with our 'White oil'.

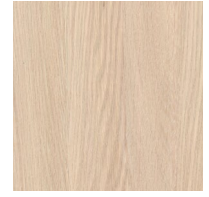

OAK C8
Soaped

We treated this wood with soap.



OAK C11
Dark grey oiled

We treated this wood with our 'Dark grey oil'.



OAK C12
Antique brown oiled

We treated this wood with our 'Antique brown oil'.



OAK C13
Light grey oiled

We treated this wood with our 'Light grey oil'.



OAK C14
Black oiled

We treated this wood with black stain, and treated it with a wax oil.

C14 is for legs and storage furniture only!



OAK C15
Mocca brown oiled

We treated this wood with our 'Mocca brown oil'.

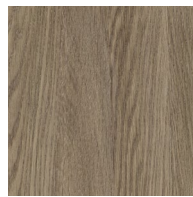

OAK C20
Grey brown oiled

We treated this wood with our 'Grey brown oil'.



OAK C44
Black matt lacquered

We treated this wood with black stain, and treated it with matt lacque.

C44 is only for plates and can only be made for products without patination.



We also offers our own repairoils for our products - contact us if you need a pricelist.

WOOD FINISH



UP

Without patination

The wood is planned and sanded to achieve a smooth surface.

With few and smaller knots.

Storage furniture can only be made with this finish!

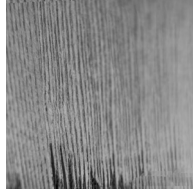

AP

Antique patination

Scratches and other fake signs of wear is added to give the wood a patinated look as if the wood has been worn.

May contain more and larger knots.



SC

Soft Cracks

Naturally occurring cracks are made more visible which gives a rustic look with cracks in the surface.

May contain more and larger knots.



RL

Raw Look

We brush off the layer of softer wood which gives a look of wood that has been roughened by natural wear.

May contain more and larger knots.

GUIDE | fillings

table top **w/fillings**

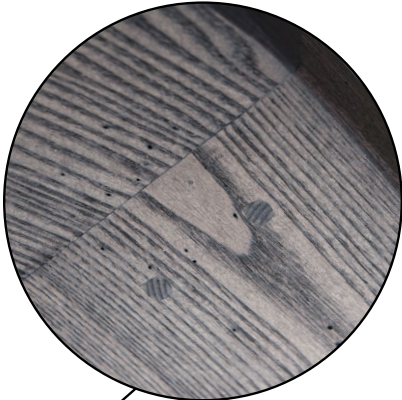
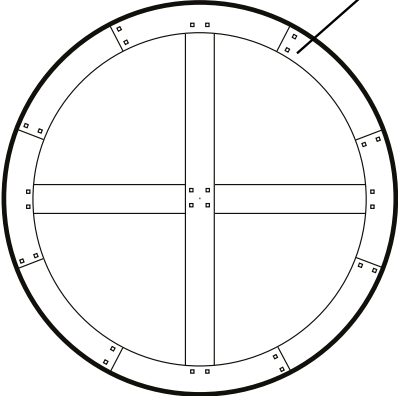
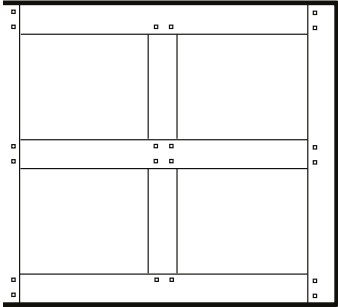

table top **w/o fillings**

