

TERRIGENA FURNITURE

FOREST RANGE

price list 2020



Terrigena Furniture
tel: 01604 696030
Rural Shopping Yard
Castle Ashby, Northants. NN7 1LF

www.terrigenafurniture.co.uk

PRICELIST | Forest, furniture range

TERRIGENA FURNITURE



Note: You can order all Forest tables with an angled, straight or natural curved edge profile!



PRICELIST | Forest table tops

TERRIGENA FURNITURE

CHOOSE: 1, 2 or 3 planks

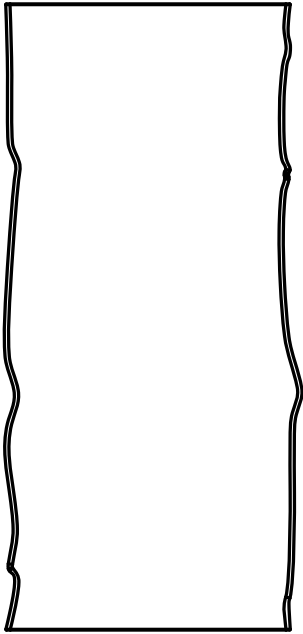

1-plank

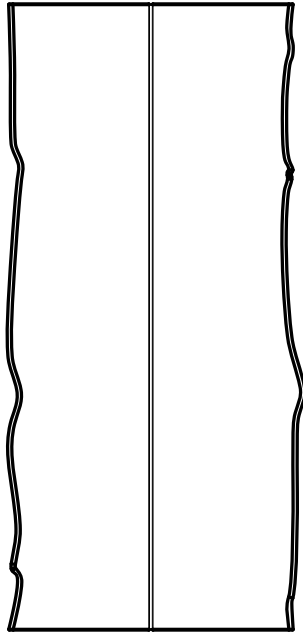

2-plank

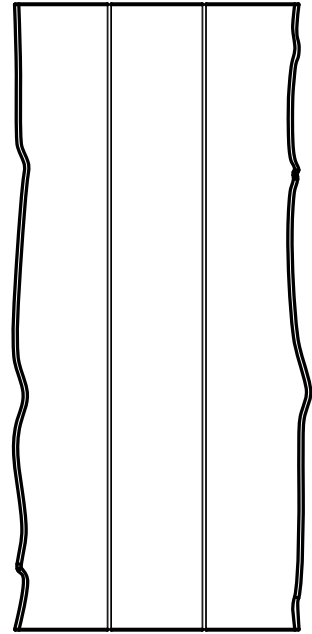

3-plank

CHOOSE: angled, straight or natural curved edge profile

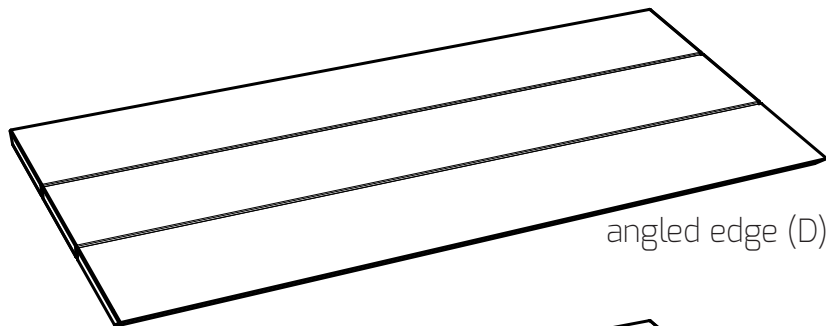

angled edge (D)

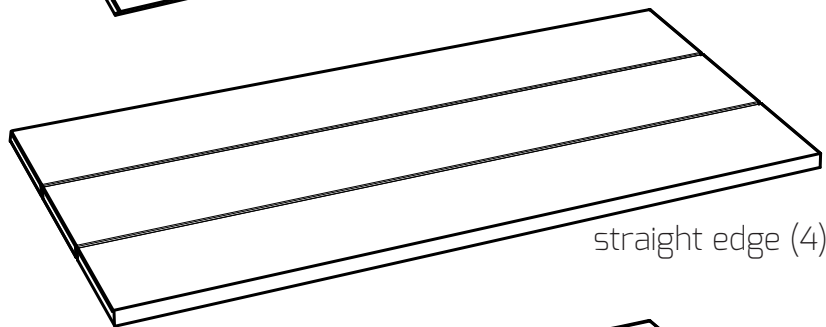

straight edge (4)

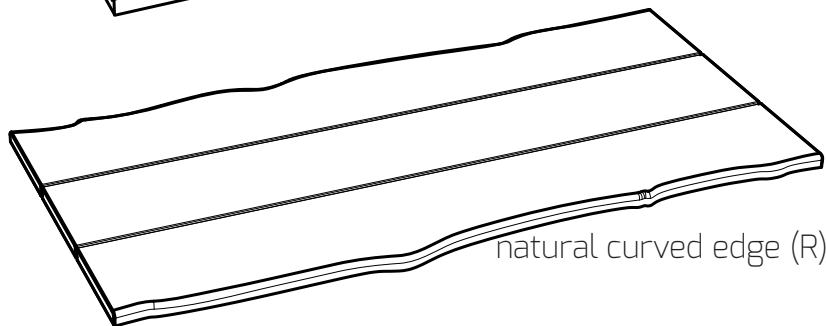

natural curved edge (R)

PRICELIST | Forest 1-plank oak

TERRIGENA FURNITURE



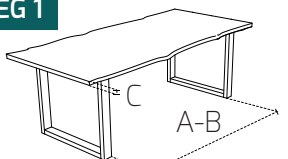
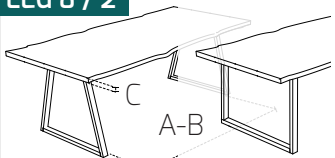
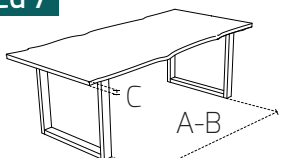



description + drawing	A-B on leg 6 +21cm dimensions (cm)				C = 3 cm price (GBP)			C = 4 cm price (GBP)		
	L	W	H	A-B	Item nr.	legs in steel: A / B / D	legs in stain- less steel: C	Item nr.	legs in steel: A / B / D	legs in stain- less steel: C
LEG X or HX or 6										
 <p>Solid 1-plank top in oak. "X": X-leg in steel 10x2 cm. "HX": X-leg in steel 10x10 cm. "6": U-leg in steel 10x1 cm.</p>	160	90	75	94	00207-X	1599		00227-X	1759	
	180	90	75	114	00209-X	1682		00229-X	1851	
	200	100	75	134	00210-X	1827		00230-X	2009	
	220	100	75	154	00211-X	1950		00231-X	2144	
	240	100	75	174	00213-X	2058		00233-X	2265	
	260	100	75	194	00215-X	2265		00235-X	2490	
	290	100	75	224	00217-X	2718		00237-X	2990	
LEG 1										
 <p>Solid 1-plank top in oak. U-legs in industrial or brushed steel 8x4 cm.</p>	160	90	75	98	00207-1	1390	1530	00227-1	1530	1683
	180	90	75	118	00209-1	1462	1611	00229-1	1611	1770
	200	100	75	138	00210-1	1588	1746	00230-1	1746	1921
	220	100	75	158	00211-1	1696	1865	00231-1	1865	2052
	240	100	75	178	00213-1	1791	1968	00233-1	1968	2166
	260	100	75	198	00215-1	1968	2166	00235-1	2166	2382
	290	100	75	228	00217-1	2362	2598	00237-1	2598	2859
LEG 8 / 2										
 <p>Solid 1-plank top in oak. trapez legs 8 or U-legs 2 in steel 5x3 cm.</p>	160	90	75	104	00207-8	1390	1530	00227-8	1530	1683
	180	90	75	124	00209-8	1462	1611	00229-8	1611	1770
	200	100	75	144	00210-8	1588	1746	00230-8	1746	1921
	220	100	75	164	00211-8	1696	1865	00231-8	1865	2052
	240	100	75	184	00213-8	1791	1968	00233-8	1968	2166
	260	100	75	204	00215-8	1968	2166	00235-8	2166	2382
	290	100	75	234	00217-8	2362	2598	00237-8	2598	2859
LEGS IN OAK!										
LEG 7										
 <p>Solid 1-plank top in oak. U-legs in oak 8x4 cm.</p>	160	90	75	98	00207-7	1390		00227-7	1530	
	180	90	75	118	00209-7	1462		00229-7	1611	
	200	100	75	138	00210-7	1588		00230-7	1746	
	220	100	75	158	00211-7	1696		00231-7	1865	
	240	100	75	178	00213-7	1791		00233-7	1968	
	260	100	75	198	00215-7	1968		00235-7	2166	
	290	100	75	228	00217-7	2362		00237-7	2598	
Leave for diningtables	50	90			00200	258		00220	283	
	50	100			00201	274		00221	303	

PRICELIST | Forest benches

TERRIGENA FURNITURE







description + drawing	Item nr.	dimensions (cm)			price (GBP)			
		L	W	H			oak	
							legs of steel: A / B	legs of steel: C
LEG 1								
 <p>Bench in solid wood. C = 4 cm. U-legs in steel. 8x4 cm.</p>	00630-1	160	40	45			762	839
	00631-1	180	40	45			787	866
	00632-1	200	40	45			812	893
	00633-1	220	40	45			837	920
	00634-1	240	40	45			936	1028
LEG X								
 <p>Bench in solid wood. C = 4 cm. X-legs in steel. 10x2 cm.</p>	00630-X	160	40	45			877	
	00631-X	180	40	45			904	
	00632-X	200	40	45			933	
	00633-X	220	40	45			963	
	00634-X	240	40	45			1075	
LEG 6								
 <p>Bench in solid wood. C = 4 cm. U-legs in steel. 10x1 cm.</p>	00630-6	160	40	45			1010	
	00631-6	180	40	45			1041	
	00632-6	200	40	45			1073	
	00633-6	220	40	45			1107	
	00634-6	240	40	45			1237	
LEGS IN WOOD !!								
LEG 7								
 <p>Bench in solid wood. C = 4 cm. U-legs in wood. 8x4 cm.</p>	00630-7	160	40	45			762	
	00631-7	180	40	45			787	
	00632-7	200	40	45			812	
	00633-7	220	40	45			837	
	00634-7	240	40	45			936	

PRICELIST | Forest, storage furniture

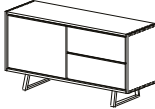
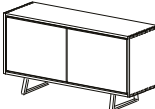
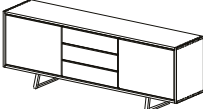
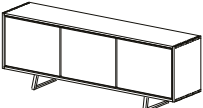

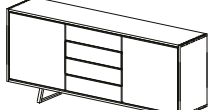
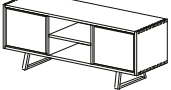
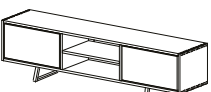
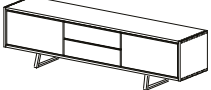
CHOOSE: Trapez leg **8**, U-leg **2** (steel) or U-leg **7** (wood) !!

description + drawing	item no.	dimensions (cm)			price (GBP)			
		W	D	H	OAK			
					steel: A / B	stainl. steel: C		
Sideboard in solid wood + veneer. 1 door + 2 drawers. 	6940- 8/2/7	135	45	70			1368	1503
Sideboard in solid wood + veneer. 2 doors. 	6941- 8/2/7	135	45	70			1305	1435
Sideboard in solid wood + veneer. 2 doors, 3 drawers. 	6942- 8/2/7	200	45	70			1831	2013
Sideboard in solid wood + veneer. 3 doors. 	6943- 8/2/7	200	45	70			1730	1903
Sideboard in solid wood + veneer. 1 door, 4 drawers. 	6930- 8/2/7	135	45	87			1689	1975
Sideboard in solid wood + veneer. 2 doors, 4 drawers. 	6932- 8/2/7	200	45	87			2018	2421
TV-board in solid wood + veneer. 2 doors + 1 shelf. 3 holes for wires in the back. 	6980- 8/2/7	135	45	53			1044	1149
TV-board in solid wood + veneer. 2 doors + 1 shelf. 3 holes for wires in the back. 	6981- 8/2/7	200	45	53			1377	1516
TV-board in solid wood + veneer. 2 flip-down doors + 2 regular doors. 2 holes for wires in the back. 	6982- 8/2/7	200	45	53			1579	1737
High-board in solid wood + veneer. 3 doors + 3 drawers. 	5149- 8/2/7	120	50	135			1883	2072

PRICELIST | Forest 1-plank, coffee tables

TERRIGENA FURNITURE

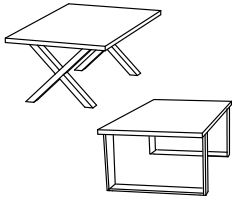
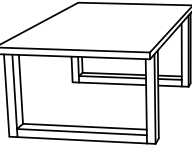
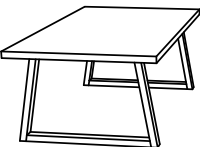
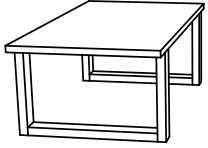

description + drawing	Item nr.	dimensions (cm)			price (GBP)				
		L	W	H			oak		
							legs of steel:	legs of steel: C	
LEG X or 6  <p>Coffee table with 3 cm top solid wood plate - normal or debarked edge. Leg X: 8x2 or leg 6: U-legs in steel 10x1 cm.</p>	00255-X	60	60	45			663		
	00256-X	90	90	45			738		
	00257-X	115	65	45			717		
	00258-X	130	70	45			785		
	00259-X	140	80	45			843		
LEG 1  <p>Coffee table with 3 cm top solid wood plate - normal or debarked edge. U-legs in steel 8x4 cm.</p>	00255-1	60	60	45			663	729	
	00256-1	90	90	45			738	812	
	00257-1	115	65	45			717	789	
	00258-1	130	70	45			785	864	
	00259-1	140	80	45			843	927	
LEG 8  <p>Coffee table with 3 cm top solid wood plate - normal or debarked edge. Trapez-legs in steel 5x3 cm.</p>	00255-8	60	60	45			663	729	
	00256-8	90	90	45			738	812	
	00257-8	115	65	45			717	789	
	00258-8	130	70	45			785	864	
	00259-8	140	80	45			843	927	
LEGS IN WOOD !!									
LEG 7  <p>Coffee table with 3 cm top solid wood plate - normal or debarked edge. U-legs in wood 8x4 cm.</p>	00255-7	60	60	45			663		
	00256-7	90	90	45			738		
	00257-7	115	65	45			717		
	00258-7	130	70	45			785		
	00259-7	140	80	45			843		

WOOD COLOURS



OAK C3 / ASH C3
Lacquered

We treated this wood with lacque.

C3 are only made for products without patination.



OAK C4 / ASH C4
Natural oiled

We treated this wood with our 'Natural oil'.



OAK C6 / ASH C6
White oiled

We treated this wood with our 'White oil'.



OAK C8 / ASH C8
Soaped

We treated this wood with soap.



OAK C11 / ASH C11
Dark grey oiled

We treated this wood with our 'Dark grey oil'.



OAK C12 / ASH C12
Antique brown oiled

We coloured this wood with our 'Antique brown oil'.



OAK C13 / ASH C13
Light grey oiled

We treated this wood with our 'Light grey oil'.



OAK C14 / ASH C14
Black oiled

We coloured this wood with black stain, and treated it with a wax oil.

C14 is for legs and storage furniture only!



OAK C15 / ASH C15
Mocca brown oiled

We coloured this wood with our 'Mocca brown oil'.



ASH C16
Warm white oiled

We coloured this wood with our 'Warm white oil'.

C16 is only for ash



OAK C20 / ASH C20
Grey brown oiled

We coloured this wood with our 'Grey brown oil'.



OAK C44 / ASH C44
Black matt lacquered

We coloured this wood with black stain, and treated it with matt lacque.

C44 is only for plates and can only be made for products without patination.

WOOD FINISH



UP

Without patination

The wood is planned and sanded to achieve a smooth surface.

With few and smaller knots.

Storage furniture can only be made with this finish!

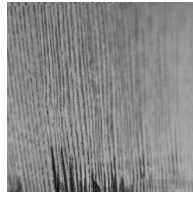

AP

Antique patination

Scratches and other fake signs of wear is added to give the wood a patinated look as if the wood has been worn.

May contain more and larger knots.



SC

Soft Cracks

Naturally occurring cracks are made more visible which gives a rustic look with cracks in the surface.

May contain more and larger knots.

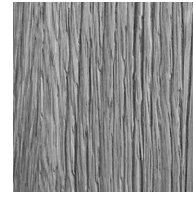

RL

Raw Look

We brush off the layer of softer wood which gives a look of wood that has been roughened by natural wear.

May contain more and larger knots.



FK

Filled Knots

The knots are filled and the wood is planned and sanded to achieve a smooth surface.

Only for OAK!

STEEL COLOUR & FINISH

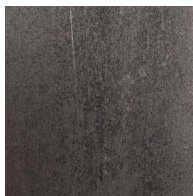

A

Industrial steel

Industrial steel has a raw and matte appearance with shades of colors emerged during casting.

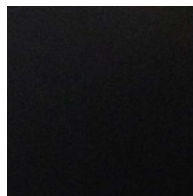

B

Black painted steel

Black painted steel has a graphical and simple look, that fits nicely in most homes.



C

Brushed stainless steel

Brushed, stainless steel has an elegant appearance with a uniform finish created by hand.

SPACERS

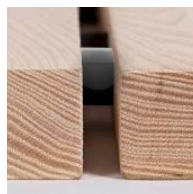

The spacers between the planks will be same material/finish as you choose the legs to be.

PRICELIST | care products

TERRIGENA FURNITURE

TIP: Give your new product a post-treatment with oil or wax before you start using it!

We offer you a selection of care products - specially developed for our range!



NATURE OIL | 600 ml

36 GBP



WAX OIL | 500 ml

36 GBP



WHITE OIL | 500 ml

36 GBP



BLACK OIL | 500 ml

36 GBP



LIGHT GREY OIL | 500 ml

36 GBP



WAX | 180 ml

23 GBP



SOAP | 600 ml

28 GBP