

2X

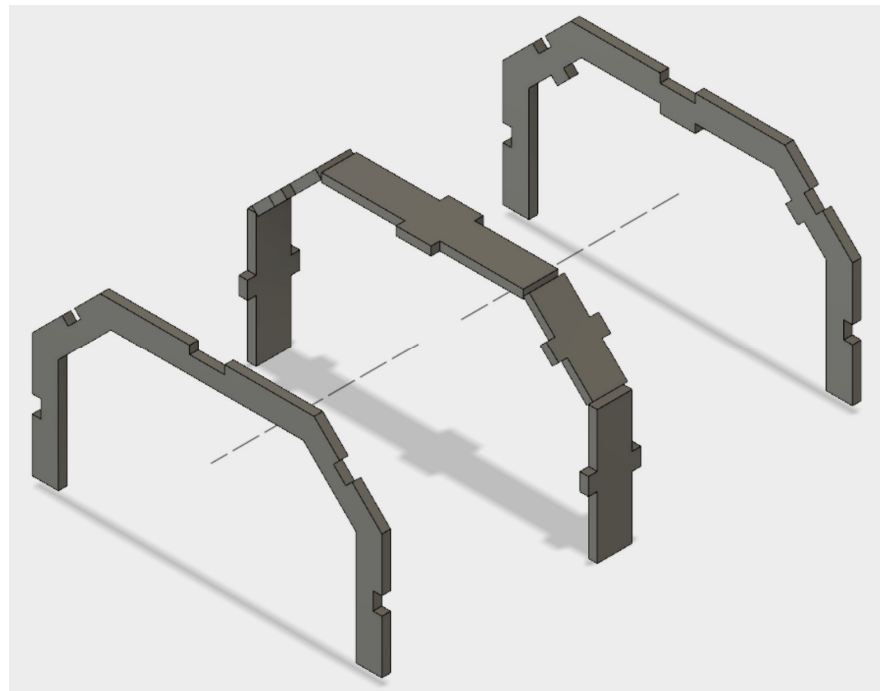

1X

