



aerospace
climate control
electromechanical
filtration
fluid & gas handling
hydraulics
pneumatics
process control
sealing & shielding



FOR HVAC/R
RATED UP TO
700 PSI

KSP48
36/17
1/2"

ZoomLock®

**FLAME-FREE
REFRIGERANT FITTINGS**

ZoomLock® Flame-Free Refrigerant Fittings

Catalog K-1, Engineering Submittal, May 2018



ENGINEERING YOUR SUCCESS.

PARKER SAFETY GUIDE FOR SELECTING AND USING ZOOMLOCK FITTINGS AND RELATED ACCESSORIES

WARNING

FAILURE TO FOLLOW INSTALLATION INSTRUCTIONS, IMPROPER SELECTION OR IMPROPER USE OF ZOOMLOCK FITTINGS AND RELATED ACCESSORIES (“PRODUCTS”) CAN CAUSE DEATH, PERSONAL INJURY AND PROPERTY DAMAGE. POSSIBLE CONSEQUENCES OF FAILURE, IMPROPER SELECTION OR IMPROPER USE OF THESE PRODUCTS INCLUDE BUT ARE NOT LIMITED TO:

- Fittings thrown off at high speed.
- High velocity fluid discharge.
- Explosion or burning of the conveyed fluid.
- Electrocution from high voltage electric power lines.
- Contact with suddenly moving or falling objects that are controlled by the conveyed fluid.
- Injections by high-pressure fluid discharge.
- Dangerously whipping copper line.
- Contact with conveyed fluids that may be hot, cold, toxic or otherwise injurious.
- Sparking or explosion caused by static electricity buildup or other sources of electricity.
- Sparking or explosion from flammable liquids.

BEFORE SELECTING OR USING ANY OF THESE PRODUCTS, IT IS IMPORTANT THAT YOU READ AND FOLLOW THE INSTALLATION INSTRUCTIONS.

KEY STEPS FOR SAFETY

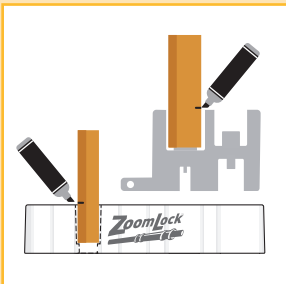

**MARK
TUBE DEPTH**

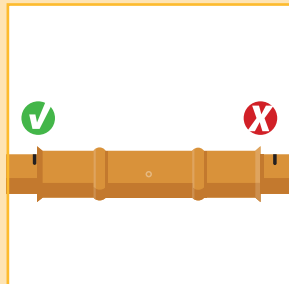

**CHECK
TUBE DEPTH**

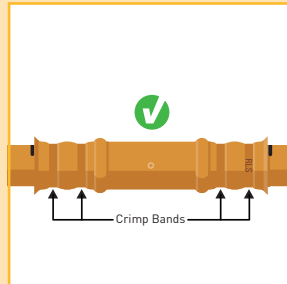

**CHECK FOR “RLS”
MARK AFTER CRIMP**

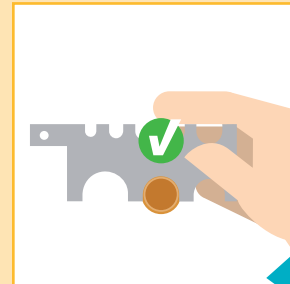

**CHECK CRIMP
WITH CRIMP GAUGE**

⚠ WARNING – USER RESPONSIBILITY

Failure or improper selection or improper use of the products described herein or related items can cause death, personal injury and property damage.

This document and other information from Parker Hannifin Corporation, its subsidiaries and authorized distributors provide product or system options for further investigation by users having technical expertise.

The user, through its own analysis and testing, is solely responsible for making the final selection of the system and components and assuring that all performance, endurance, maintenance, safety and warning requirements of the application are met. The user must analyze all aspects of the application, follow applicable industry standards, and follow the information concerning the product in the current product catalog and in any other materials provided from Parker or its subsidiaries or authorized distributors.

To the extent that Parker or its subsidiaries or authorized distributors provide component or system options based upon data or specifications provided by the user, the user is responsible for determining that such data and specifications are suitable and sufficient for all applications and reasonably foreseeable uses of the components or systems.

For safety information see the Safety Guide at www.parker.com/safety or call 1-800-CParker.

OFFER OF SALE

The items described in this document are hereby offered for sale by Parker Hannifin Corporation, its subsidiaries or its authorized distributors. This offer and its acceptance are governed by the provisions stated in the detailed “Offer of Sale” elsewhere in this document or available at www.parker.com.

Catalog K-1, May 2018 supersedes Catalog K-1, January 2018 and all prior publications.

ZoomLock Flame-Free Refrigerant Fittings

Table of Contents

| | |
|--|----|
| Introduction | 4 |
| Flame-Free Refrigerant Fittings | |
| Couplings | 6 |
| Slip Couplings | 6 |
| Long Radius Elbows | 7 |
| Tees | 7 |
| Reducers | 8 |
| Caps | 9 |
| SAE Flare | 9 |
| Reducing Bushings | 10 |
| Long Radius Street Elbow | 10 |
| Elbow - 45° | 11 |
| Y-Joints | 11 |
| P Traps | 12 |
| Crimping Tools | 13 |
| Tool Kits | 14 |
| Jaw Kits | 14 |
| Crimping Tools and Jaw Selection | 15 |
| Replacement Parts and Accessories | 17 |
| Installation Instructions | 18 |
| Troubleshooting and Frequently Asked Questions | 20 |
| Performance Data | 24 |
| ICC-ES Evaluation Report | 25 |
| Helium Leak Test Report | 27 |
| Time and Motion Study | 29 |
| Terms of Sale with Warranty Limitations | 30 |



Fittings
pages 6-12

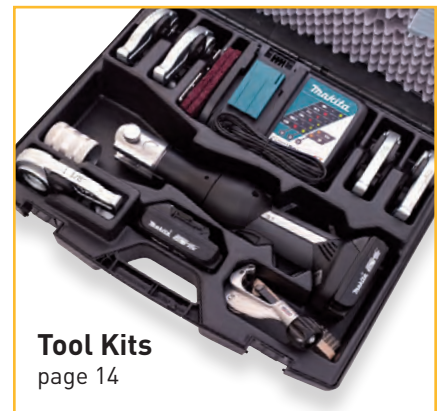

Tool Kits
page 14



Jaw Kits
page 14

Compatible Components

To make a system convenient to install, ODM x ODM ZoomLock compatible components are available including:

- Ball Valves
- Filter-Driers
- Moisture and Liquid Indicators
- Solenoid Valves



ATTENTION!

WARRANTY COULD BE VOID IF ZOOMLOCK IS NOT APPLIED PER INSTRUCTIONS! CAREFULLY READ ALL INSTALLATION INSTRUCTIONS (SEE PAGES 18-19) AND WATCH VIDEOS.



<http://solutions.parker.com/zoomvid>

ZoomLock®

FLAME-FREE REFRIGERANT FITTINGS

Increase productivity and profitability

ZoomLock® flame-free refrigerant fittings are specially designed to work without brazing, which automatically makes your job simpler and faster when joining copper tubes.

Professionals who have tried ZoomLock flame-free refrigerant fittings report their time and labor costs on tube connections are typically reduced 60% on average by eliminating the need for brazing. The biggest benefits are **more productivity and increased profit**, but there are also many other exciting advantages to flame-free tube connecting.

The ZoomLock flame-free fittings technology is patented and manufactured in the USA by RLS LLC, a Marmon Berkshire-Hathaway company. RLS LLC leverages over 100 years of copper forming experience with its sister-division Cerro Flow Products.



The ZoomLock Advantage

- For HVAC/R up to 700 psi
- Huge labor and time savings
- Less equipment required
- Safer conditions
no fire hazards
- No hot-work permits
- No need to
nitrogen-purge
- More flexible access
to job sites



ZoomLock Flame-Free Refrigerant Fittings



Applications

- High Pressure HVAC/R
- Glycol
- Non-Potable Water

Product Parameters

- **Continuous Operating Temperature:**
250°F / 121°C
- **O-Ring Temperature Rating:**
-40°F to +300°F
-40°C to +149°C
- **Maximum Rated Pressure (MRP):**
700 psi / 48 bar
- **Minimum Burst Pressure (UL 207):**
2,100 psi / 145 bar
- **Vacuum Pressure Capability:**
20 Microns
- **External Leak Rate:**
<0.1 Ounces of Helium per Year at Operating Pressure Range
- **Vibration Resistance:**
Conforms to UL109
- **Size Availability (Inches):**
1/4, 5/16, 3/8, 1/2, 5/8, 3/4, 7/8, 1-1/8, 1-3/8
- **Coming Soon:**
1-5/8", 2-1/8"

Fitting Materials

- **Fitting Body:**
Refrigerant Grade Copper, per ASTM-B75 or ASTM-B743
- **O-Ring:**
HNBR

Fitting Warranty

- Read page 30 for more details.

Compatibility

- **Approved Oils:** Mineral Oil, POE, PVE, PAG
- **Approved Tubing Materials:**
Copper to Copper Connections
- **Approved Tubing Tolerance:**
ASTM B280, UNI EN 12735
- **Approved Copper Tubing Types for Use with Klauke® 19 kN and RIDGID® Compatible Jaws:**
Hard Copper (Drawn)
 - 1/4" – 1-3/8" Type ACR, M, L, K
 Soft Copper (Annealed)
 - 1/4" – 1-3/8" Type ACR, L, K
- **Approved Copper Tubing Types for Use with Klauke® 15 kN Compatible Jaws:**
Hard Copper (Drawn)
 - 1/4" – 1-1/8" Type ACR, M, L
 - Type K only up to 7/8"
 Soft Copper (Annealed)
 - 1/4" – 1-1/8" Type ACR, L
 - Type K only up to 7/8"

Agency Approvals and Certifications

- UL Listed: 207, SA#33958, SDTW(7) (Except where noted)
- UL Listed: Approved use for field and factory installations
- ASHRAE-15, ANSI 15, ASME B31.5, ANSI 31.5
- ICC-ES, PMG-1296
2018, 2015, 2012, 2009, 2006
International Mechanical Code (IMC)
2018, 2015, 2012, 2009, 2006
International Residential Code (IRC)
2018, 2015, 2012, 2009, 2006
Uniform Mechanical Code (UMC)
- CRN - Approved for couplings and 90 degree elbows. Others coming soon.

Approved Refrigerants

- | | | |
|---------|---------|-------------------|
| ■ 32* | ■ 424A | ■ 453A |
| ■ 125 | ■ 427A | ■ 454A* |
| ■ 134a | ■ 434A | ■ 454B* |
| ■ 143a* | ■ 437A | ■ 454C* |
| ■ 152a* | ■ 438A | ■ 455A* |
| ■ 227ea | ■ 442A | ■ 456A |
| ■ 290* | ■ 444A* | ■ 457A* |
| ■ 404A | ■ 444B* | ■ 458A |
| ■ 407A | ■ 445A* | ■ 507A |
| ■ 407B | ■ 446A* | ■ 513A |
| ■ 407C | ■ 447A* | ■ 513B |
| ■ 407F | ■ 448A | ■ 515A |
| ■ 407G | ■ 449A | ■ 515B |
| ■ 407H | ■ 449B | ■ 600* |
| ■ 410A | ■ 449C | ■ 600a* |
| ■ 417A | ■ 450A | ■ 718 |
| ■ 421A | ■ 451A* | ■ 1234yf* |
| ■ 422A | ■ 451B* | ■ 1234ze* |
| ■ 422B | ■ 452A | ■ Ethylene Glycol |
| ■ 422C | ■ 452B* | |
| ■ 422D | ■ 452C | |

* Flammable refrigerants. Check with local building or mechanical code officials.

Refer to ZoomLock.com for the latest approved refrigerants list.

Patents



- Refer to the following website for an up-to-date list of patents:
<http://www.rlspressfittings.com/patents/>



RIDGID is a registered trademark of RIDGID, Inc.

ZoomLock Flame-Free Refrigerant Fittings

Couplings



Dimensions

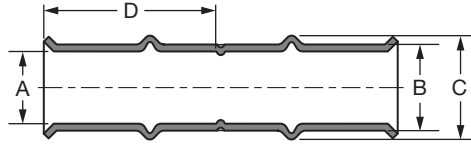

| Size | Part Number | Description | Dimensions | | | | | | | |
|--------|-------------|--------------|------------|------|------|------|------|------|------|------|
| | | | A | | B | | C | | D | |
| | | | Inch | mm | Inch | mm | Inch | mm | Inch | mm |
| 1/4 | 770500 | PZK-C4-HNBR | 0.26 | 6.6 | 0.34 | 8.6 | 0.45 | 11.5 | 0.95 | 24.1 |
| 5/16 | 770501 | PZK-C5-HNBR | 0.32 | 8.2 | 0.40 | 10.2 | 0.52 | 13.1 | 0.93 | 23.6 |
| 3/8 | 770502 | PZK-C6-HNBR | 0.39 | 9.8 | 0.47 | 11.8 | 0.59 | 15.0 | 0.98 | 24.9 |
| 1/2 | 770503 | PZK-C8-HNBR | 0.51 | 13.0 | 0.59 | 15.0 | 0.73 | 18.6 | 1.25 | 31.8 |
| 5/8 | 770504 | PZK-C10-HNBR | 0.64 | 16.1 | 0.74 | 18.7 | 0.89 | 22.5 | 1.24 | 31.5 |
| 3/4 | 770505 | PZK-C12-HNBR | 0.76 | 19.3 | 0.88 | 22.4 | 1.07 | 27.2 | 1.29 | 32.8 |
| 7/8 | 770506 | PZK-C14-HNBR | 0.89 | 22.5 | 1.02 | 25.8 | 1.19 | 30.2 | 1.31 | 33.3 |
| 1 | 770513 | PZK-C16-HNBR | 1.01 | 25.7 | 1.16 | 29.5 | 1.36 | 34.6 | 1.31 | 33.3 |
| 1-1/8 | 770507 | PZK-C18-HNBR | 1.14 | 28.8 | 1.29 | 32.6 | 1.44 | 36.7 | 1.29 | 32.8 |
| 1-3/8* | 770508 | PZK-C22-HNBR | 1.39 | 35.3 | 1.54 | 39.1 | 1.75 | 44.5 | 1.57 | 39.9 |

Slip Couplings



Dimensions

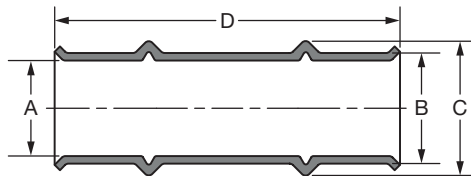

| Size | Part Number | Description | Dimensions | | | | | | | |
|--------|-------------|---------------|------------|------|------|------|------|------|------|------|
| | | | A | | B | | C | | D | |
| | | | Inch | mm | Inch | mm | Inch | mm | Inch | mm |
| 1/4 | 770550 | PZK-RC4-HNBR | 0.26 | 6.6 | 0.34 | 8.6 | 0.45 | 11.5 | 2.00 | 50.8 |
| 3/8 | 770552 | PZK-RC6-HNBR | 0.39 | 9.8 | 0.47 | 11.8 | 0.59 | 15.0 | 2.05 | 52.1 |
| 1/2 | 770553 | PZK-RC8-HNBR | 0.51 | 13.0 | 0.59 | 15.0 | 0.73 | 18.6 | 2.74 | 69.6 |
| 5/8 | 770554 | PZK-RC10-HNBR | 0.64 | 16.1 | 0.74 | 18.7 | 0.89 | 22.5 | 2.75 | 69.9 |
| 3/4 | 770555 | PZK-RC12-HNBR | 0.76 | 19.3 | 0.88 | 22.4 | 1.07 | 27.2 | 2.75 | 69.9 |
| 7/8 | 770556 | PZK-RC14-HNBR | 0.89 | 22.5 | 1.02 | 25.8 | 1.19 | 30.2 | 2.74 | 69.9 |
| 1-1/8 | 770557 | PZK-RC18-HNBR | 1.14 | 28.8 | 1.29 | 32.6 | 1.44 | 36.7 | 2.77 | 70.4 |
| 1-3/8* | 770558 | PZK-RC22-HNBR | 1.39 | 35.3 | 1.54 | 39.1 | 1.75 | 44.5 | 3.15 | 80.0 |

*ZoomLock 1-3/8" fittings can only be crimped with 19 kN Klauke tools or RIDGID crimping jaws.

ZoomLock Flame-Free Refrigerant Fittings

Long Radius Elbows



Dimensions

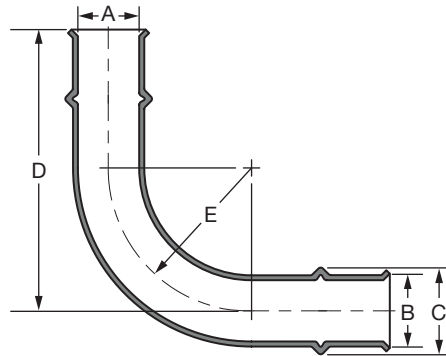

| Size | Part Number | Description | Dimensions | | | | | | | | | |
|--------|-------------|----------------|------------|------|------|------|------|------|------|-------|----------|------|
| | | | A | | B | | C | | D | | E (Ref.) | |
| | | | Inch | mm | Inch | mm | Inch | mm | Inch | mm | Inch | mm |
| 1/4 | 770600 | PZK-90E4-HNBR | 0.26 | 6.6 | 0.34 | 8.6 | 0.45 | 11.5 | 2.01 | 51.1 | 0.50 | 12.7 |
| 5/16 | 770601 | PZK-90E5-HNBR | 0.32 | 8.2 | 0.40 | 10.2 | 0.52 | 13.1 | 2.13 | 54.1 | 0.60 | 15.2 |
| 3/8 | 770602 | PZK-90E6-HNBR | 0.39 | 9.8 | 0.47 | 11.8 | 0.59 | 15.0 | 2.27 | 57.7 | 0.65 | 16.5 |
| 1/2 | 770603 | PZK-90E8-HNBR | 0.51 | 13.0 | 0.59 | 15.0 | 0.73 | 18.6 | 2.88 | 73.2 | 0.90 | 22.9 |
| 5/8 | 770604 | PZK-90E10-HNBR | 0.64 | 16.1 | 0.74 | 18.7 | 0.89 | 22.5 | 3.21 | 81.4 | 1.13 | 28.7 |
| 3/4 | 770605 | PZK-90E12-HNBR | 0.76 | 19.3 | 0.88 | 22.4 | 1.07 | 27.2 | 3.47 | 88.0 | 1.50 | 38.1 |
| 7/8 | 770606 | PZK-90E14-HNBR | 0.89 | 22.5 | 1.02 | 25.8 | 1.19 | 30.2 | 3.75 | 95.3 | 2.25 | 57.2 |
| 1-1/8 | 770607 | PZK-90E18-HNBR | 1.14 | 28.8 | 1.29 | 32.6 | 1.44 | 36.7 | 4.29 | 108.8 | 2.85 | 72.4 |
| 1-3/8* | 770608 | PZK-90E22-HNBR | 1.39 | 35.3 | 1.54 | 39.1 | 1.75 | 44.5 | 4.54 | 115.3 | 3.05 | 77.5 |

Tees



Dimensions

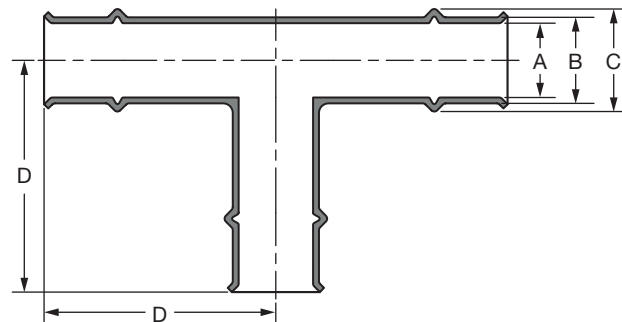

| Size | Part Number | Description | Dimensions | | | | | | | |
|--------|-------------|--------------|------------|------|------|------|------|------|------|------|
| | | | A | | B | | C | | D | |
| | | | Inch | mm | Inch | mm | Inch | mm | Inch | mm |
| 3/8 | 770702 | PZK-T6-HNBR | 0.39 | 9.8 | 0.47 | 11.8 | 0.59 | 15.0 | 1.63 | 41.4 |
| 1/2 | 770703 | PZK-T8-HNBR | 0.51 | 13.0 | 0.59 | 15.0 | 0.72 | 18.2 | 2.23 | 56.6 |
| 5/8 | 770704 | PZK-T10-HNBR | 0.64 | 16.1 | 0.74 | 18.7 | 0.87 | 22.0 | 2.29 | 58.2 |
| 3/4 | 770705 | PZK-T12-HNBR | 0.76 | 19.3 | 0.88 | 22.4 | 1.05 | 26.6 | 2.37 | 60.2 |
| 7/8 | 770706 | PZK-T14-HNBR | 0.89 | 22.5 | 1.02 | 25.8 | 1.19 | 30.2 | 2.44 | 62.0 |
| 1-1/8 | 770707 | PZK-T18-HNBR | 1.14 | 28.8 | 1.29 | 32.6 | 1.44 | 36.7 | 2.56 | 65.0 |
| 1-3/8* | 770708 | PZK-T22-HNBR | 1.39 | 35.2 | 1.54 | 39.0 | 1.75 | 44.4 | 2.75 | 69.9 |

*ZoomLock 1-3/8" fittings can only be crimped with 19 kN Klauke tools or RIDGID crimping jaws.

ZoomLock Flame-Free Refrigerant Fittings

Reducers



Dimensions

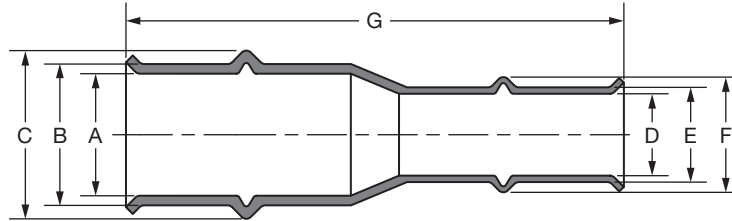

| Size | Part Number | Description | Dimensions | | | | | | | | | | | | | |
|-------------------|-------------|----------------|------------|------|------|------|------|------|------|------|------|------|------|------|------|------|
| | | | A | | B | | C | | D | | E | | F | | G | |
| | | | Inch | mm | Inch | mm | Inch | mm | Inch | mm | Inch | mm | Inch | mm | Inch | mm |
| 3/8 in to 1/4 | 770800 | PZK-R64-HNBR | 0.39 | 9.8 | 0.47 | 11.8 | 0.59 | 15.0 | 0.26 | 6.6 | 0.34 | 8.6 | 0.45 | 11.5 | 2.20 | 55.9 |
| 1/2 in to 1/4 | 770808 | PZK-R84-HNBR | 0.51 | 13.0 | 0.59 | 15.0 | 0.73 | 18.6 | 0.26 | 6.6 | 0.34 | 8.6 | 0.45 | 11.5 | 2.63 | 66.8 |
| 1/2 in to 3/8 | 770801 | PZK-R86-HNBR | 0.51 | 13.0 | 0.59 | 15.0 | 0.73 | 18.6 | 0.39 | 9.8 | 0.47 | 11.8 | 0.59 | 15.0 | 2.63 | 66.8 |
| 5/8 in to 1/4 | 770809 | PZK-R104-HNBR | 0.64 | 16.1 | 0.74 | 18.7 | 0.89 | 22.5 | 0.26 | 6.6 | 0.34 | 8.6 | 0.45 | 11.5 | 2.70 | 68.6 |
| 5/8 in to 3/8 | 770810 | PZK-R106-HNBR | 0.64 | 16.1 | 0.74 | 18.7 | 0.89 | 22.5 | 0.39 | 9.8 | 0.47 | 11.8 | 0.59 | 15.0 | 2.70 | 68.6 |
| 5/8 in to 1/2 | 770802 | PZK-R108-HNBR | 0.64 | 16.1 | 0.74 | 18.7 | 0.87 | 22.0 | 0.51 | 13.0 | 0.59 | 15.0 | 0.72 | 18.2 | 3.00 | 76.2 |
| 3/4 in to 1/2 | 770811 | PZK-R128-HNBR | 0.76 | 19.3 | 0.88 | 22.4 | 1.05 | 26.6 | 0.51 | 13.0 | 0.59 | 15.0 | 0.72 | 18.2 | 3.10 | 78.7 |
| 3/4 in to 5/8 | 770803 | PZK-R1210-HNBR | 0.76 | 19.3 | 0.88 | 22.4 | 1.05 | 26.6 | 0.64 | 16.1 | 0.74 | 18.7 | 0.87 | 22.0 | 3.00 | 76.2 |
| 7/8 in to 1/2 | 770812 | PZK-R148-HNBR | 0.89 | 22.5 | 1.02 | 25.8 | 1.19 | 30.2 | 0.51 | 13.0 | 0.59 | 15.0 | 0.72 | 18.2 | 3.05 | 77.5 |
| 7/8 in to 5/8 | 770804 | PZK-R1410-HNBR | 0.89 | 22.5 | 1.02 | 25.8 | 1.19 | 30.2 | 0.64 | 16.1 | 0.74 | 18.7 | 0.87 | 22.0 | 3.05 | 77.5 |
| 7/8 in to 3/4 | 770805 | PZK-R1412-HNBR | 0.89 | 22.5 | 1.02 | 25.8 | 1.19 | 30.2 | 0.76 | 19.3 | 0.88 | 22.4 | 1.05 | 26.6 | 3.11 | 79.0 |
| 1 in to 7/8 | 770823 | PZK-R1614-HNBR | 1.01 | 25.7 | 1.16 | 29.5 | 1.37 | 34.7 | 0.89 | 22.5 | 1.02 | 25.8 | 1.19 | 30.2 | 3.09 | 78.5 |
| 1-1/8 in to 1/2 | 770813 | PZK-R188-HNBR | 1.14 | 28.8 | 1.29 | 32.6 | 1.44 | 36.7 | 0.51 | 13.0 | 0.60 | 15.0 | 0.72 | 18.2 | 3.25 | 82.6 |
| 1-1/8 in to 5/8 | 770814 | PZK-R1810-HNBR | 1.14 | 28.8 | 1.29 | 32.6 | 1.44 | 36.7 | 0.64 | 16.1 | 0.74 | 18.7 | 0.87 | 22.0 | 3.25 | 82.6 |
| 1-1/8 in to 3/4 | 770806 | PZK-R1812-HNBR | 1.14 | 28.8 | 1.29 | 32.6 | 1.44 | 36.7 | 0.76 | 19.3 | 0.88 | 22.4 | 1.05 | 26.6 | 3.25 | 82.6 |
| 1-1/8 in to 7/8 | 770807 | PZK-R1814-HNBR | 1.14 | 28.8 | 1.29 | 32.6 | 1.44 | 36.7 | 0.89 | 22.5 | 1.02 | 25.8 | 1.12 | 28.4 | 3.11 | 79.0 |
| 1-3/8 in to 7/8 | 770818 | PZK-R2214-HNBR | 1.39 | 35.2 | 1.64 | 41.7 | 1.75 | 44.4 | 0.89 | 22.5 | 1.13 | 28.7 | 1.19 | 30.2 | 3.66 | 93.0 |
| 1-3/8 in to 1 1/8 | 770819 | PZK-R2218-HNBR | 1.39 | 35.2 | 1.64 | 41.7 | 1.75 | 44.4 | 1.14 | 28.8 | 1.41 | 35.8 | 1.45 | 36.7 | 3.34 | 84.8 |

*ZoomLock 1-3/8" fittings can only be crimped with 19 kN Klauke tools or RIDGID crimping jaws.

ZoomLock Flame-Free Refrigerant Fittings

Caps



Dimensions

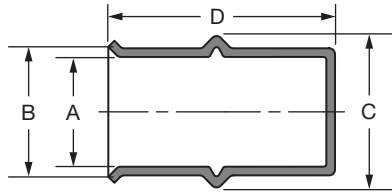

| Size | Part Number | Description | Dimensions | | | | | | | |
|--------|-------------|---------------|------------|------|------|------|------|------|------|------|
| | | | A | | B | | C | | D | |
| | | | Inch | mm | Inch | mm | Inch | mm | Inch | mm |
| 1/4 | 770900 | PZK-CP4-HNBR | 0.26 | 6.6 | 0.34 | 8.6 | 0.45 | 11.5 | 1.11 | 28.2 |
| 5/16 | 770901 | PZK-CP5-HNBR | 0.32 | 8.2 | 0.40 | 10.2 | 0.52 | 13.1 | 1.11 | 28.2 |
| 3/8 | 770902 | PZK-CP6-HNBR | 0.39 | 9.8 | 0.47 | 11.8 | 0.59 | 15.0 | 1.13 | 28.7 |
| 1/2 | 770903 | PZK-CP8-HNBR | 0.51 | 13.0 | 0.59 | 15.0 | 0.72 | 18.2 | 1.47 | 37.3 |
| 5/8 | 770904 | PZK-CP10-HNBR | 0.64 | 16.1 | 0.74 | 18.7 | 0.87 | 22.0 | 1.56 | 39.6 |
| 3/4 | 770905 | PZK-CP12-HNBR | 0.76 | 19.3 | 0.88 | 22.4 | 1.05 | 26.6 | 1.57 | 39.9 |
| 7/8 | 770906 | PZK-CP14-HNBR | 0.89 | 22.5 | 1.02 | 25.8 | 1.19 | 30.2 | 1.60 | 40.6 |
| 1-1/8 | 770907 | PZK-CP18-HNBR | 1.14 | 28.8 | 1.29 | 32.6 | 1.44 | 36.7 | 2.05 | 52.1 |
| 1-3/8* | 770908 | PZK-CP22-HNBR | 1.39 | 35.2 | 1.54 | 39.0 | 1.75 | 44.4 | 2.11 | 53.6 |

*ZoomLock 1-3/8" fittings can only be crimped with 19 kN Klauke tools or RIDGID crimping jaws.

SAE Flare



Dimensions

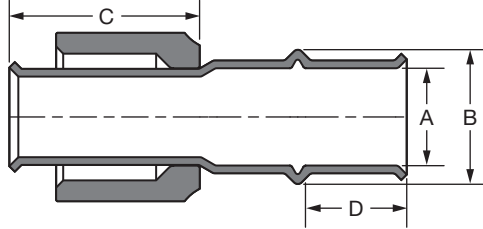

| Size | Part Number | Description | Dimensions | | | | | | | |
|------|-------------|--------------|------------|------|------|------|------|------|------|------|
| | | | A | | B | | C | | D | |
| | | | Inch | mm | Inch | mm | Inch | mm | Inch | mm |
| 1/4 | 771000 | PZK-F4-HNBR | 0.26 | 6.6 | 0.45 | 11.5 | 1.38 | 35.1 | 0.56 | 14.2 |
| 3/8 | 771002 | PZK-F6-HNBR | 0.39 | 9.8 | 0.59 | 15.0 | 1.38 | 35.1 | 0.58 | 14.7 |
| 1/2 | 771003 | PZK-F8-HNBR | 0.51 | 13.0 | 0.72 | 18.2 | 1.13 | 28.7 | 0.75 | 19.1 |
| 5/8 | 771004 | PZK-F10-HNBR | 0.64 | 16.1 | 0.87 | 22.1 | 1.48 | 37.6 | 0.75 | 19.1 |
| 3/4 | 771005 | PZK-F12-HNBR | 0.76 | 19.3 | 1.05 | 26.7 | 1.48 | 37.6 | 0.80 | 20.3 |

ZoomLock Flame-Free Refrigerant Fittings

Reducing Bushings



Dimensions

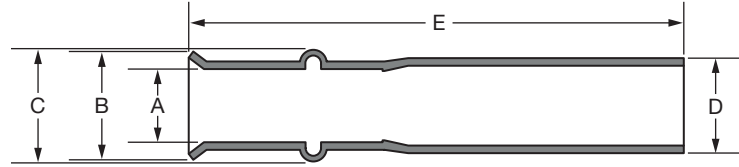

| Size | Part Number | Description | Dimensions | | | | | | | | | |
|-----------------|-------------|----------------|------------|------|------|------|------|------|------|------|------|------|
| | | | A | | B | | C | | D | | E | |
| | | | Inch | mm | Inch | mm | Inch | mm | Inch | mm | Inch | mm |
| 1/2 to 3/8 | 771502 | PZK-B86-HNBR | 0.39 | 9.8 | 0.56 | 14.2 | 0.59 | 15.0 | 0.47 | 11.8 | 2.50 | 63.5 |
| 5/8 to 1/2 | 771505 | PZK-B108-HNBR | 0.51 | 13.0 | 0.68 | 17.3 | 0.72 | 18.2 | 0.59 | 15.0 | 2.95 | 74.9 |
| 3/4 to 5/8 | 771507 | PZK-B1210-HNBR | 0.64 | 16.1 | 0.84 | 21.3 | 0.87 | 22.1 | 0.74 | 18.7 | 2.98 | 75.7 |
| 7/8 to 3/4 | 771510 | PZK-B1412-HNBR | 0.76 | 19.3 | 1.02 | 25.9 | 1.05 | 26.7 | 0.88 | 22.4 | 3.04 | 77.2 |
| 1-1/8 to 7/8 | 771514 | PZK-B1814-HNBR | 0.89 | 22.5 | 1.10 | 27.9 | 1.19 | 30.2 | 1.02 | 25.8 | 3.06 | 77.7 |
| 1-3/8 to 1-1/8* | 771519 | PZK-B2218-HNBR | 1.14 | 28.8 | 1.40 | 35.6 | 1.45 | 36.8 | 1.29 | 32.6 | 3.12 | 79.2 |

*ZoomLock 1-3/8" fittings can only be crimped with 19 kN Klauke tools or RIDGID crimping jaws.

Long Radius Street Elbow



Dimensions

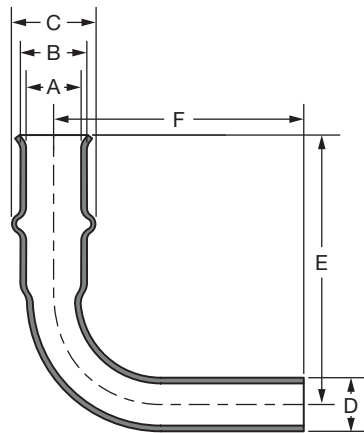

| Size | Part Number | Description | Dimensions | | | | | | | | | | | |
|--------|-------------|-----------------|------------|------|------|------|------|------|------|------|------|-------|------|-------|
| | | | A | | B | | C | | D | | E | | F | |
| | | | Inch | mm | Inch | mm | Inch | mm | Inch | mm | Inch | mm | Inch | mm |
| 3/8 | 771302 | PZK-90SE6-HNBR | 0.39 | 9.8 | 0.54 | 13.7 | 0.59 | 15.0 | 0.38 | 9.5 | 1.89 | 48.0 | 1.75 | 44.5 |
| 1/2 | 771303 | PZK-90SE8-HNBR | 0.51 | 13.0 | 0.69 | 17.5 | 0.72 | 18.2 | 0.50 | 12.7 | 2.65 | 67.3 | 2.56 | 65.0 |
| 5/8 | 771304 | PZK-90SE10-HNBR | 0.64 | 16.1 | 0.84 | 21.3 | 0.87 | 22.1 | 0.63 | 15.9 | 2.81 | 71.4 | 2.64 | 67.1 |
| 3/4 | 771305 | PZK-90SE12-HNBR | 0.76 | 19.3 | 1.03 | 26.2 | 1.05 | 26.7 | 0.75 | 19.1 | 3.15 | 80.0 | 3.00 | 76.2 |
| 7/8 | 771306 | PZK-90SE14-HNBR | 0.89 | 22.5 | 1.14 | 29.0 | 1.19 | 30.2 | 0.88 | 22.2 | 3.40 | 86.4 | 3.25 | 82.6 |
| 1-1/8 | 771307 | PZK-90SE18-HNBR | 1.14 | 28.8 | 1.41 | 35.8 | 1.45 | 36.7 | 1.13 | 28.6 | 3.93 | 99.8 | 3.80 | 96.5 |
| 1-3/8* | 771308 | PZK-90SE22-HNBR | 1.39 | 35.2 | 1.68 | 42.7 | 1.75 | 44.4 | 1.38 | 34.9 | 4.51 | 114.6 | 4.38 | 111.3 |

*ZoomLock 1-3/8" fittings can only be crimped with 19 kN Klauke tools or RIDGID crimping jaws.

ZoomLock Flame-Free Refrigerant Fittings

Elbow - 45°

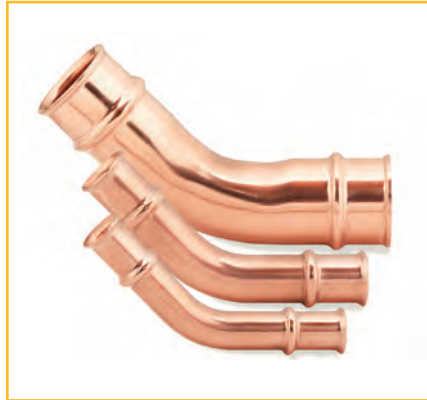

Dimensions

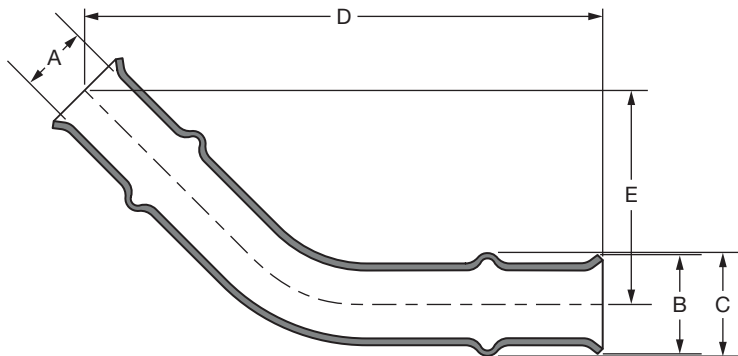

| Size | Part Number | Description | Dimensions | | | | | | | | | |
|--------|-------------|----------------|------------|------|------|------|------|------|------|-------|------|------|
| | | | A | | B | | C | | D | | E | |
| | | | Inch | mm | Inch | mm | Inch | mm | Inch | mm | Inch | mm |
| 3/8 | 771402 | PZK-45E6-HNBR | 0.39 | 9.8 | 0.56 | 14.2 | 0.59 | 15.0 | 2.96 | 75.2 | 1.26 | 32.0 |
| 1/2 | 771403 | PZK-45E8-HNBR | 0.51 | 13.0 | 0.71 | 18.0 | 0.73 | 18.6 | 3.72 | 94.5 | 1.54 | 39.1 |
| 5/8 | 771404 | PZK-45E10-HNBR | 0.64 | 16.1 | 0.86 | 21.8 | 0.88 | 22.5 | 3.97 | 100.8 | 1.64 | 41.7 |
| 3/4 | 771405 | PZK-45E12-HNBR | 0.76 | 19.3 | 1.02 | 25.9 | 1.06 | 27.0 | 4.12 | 104.6 | 1.70 | 43.2 |
| 7/8 | 771406 | PZK-45E14-HNBR | 0.89 | 22.5 | 1.13 | 28.7 | 1.19 | 30.1 | 4.38 | 111.3 | 1.82 | 46.2 |
| 1-1/8 | 771407 | PZK-45E18-HNBR | 1.14 | 28.8 | 1.41 | 35.8 | 1.45 | 36.7 | 4.84 | 122.9 | 2.00 | 50.8 |
| 1-3/8* | 771408 | PZK-45E22-HNBR | 1.39 | 35.2 | 1.68 | 42.7 | 1.75 | 44.4 | 5.67 | 144.0 | 2.55 | 64.8 |

*ZoomLock 1-3/8" fittings can only be crimped with 19 kN Klauke tools or RIDGID crimping jaws.

Y-Joints

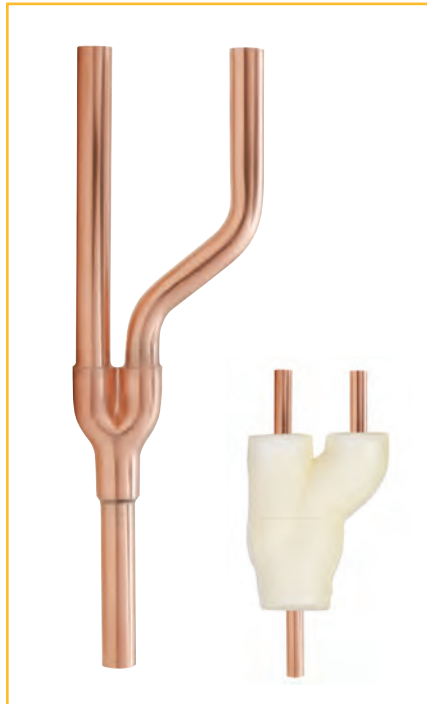

Dimensions

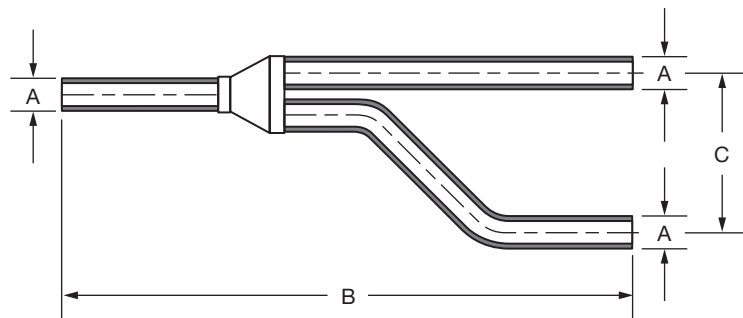

| Size | Part Number | Description | Dimensions | | | | | |
|-------|-------------|-------------|------------|------|-------|-------|------|------|
| | | | A | | B | | C | |
| | | | Inch | mm | Inch | mm | Inch | mm |
| 3/8 | 771102 | PZK-Y6-NA | 0.38 | 9.5 | 7.59 | 192.0 | 2.37 | 60.0 |
| 1/2 | 771103 | PZK-Y8-NA | 0.50 | 12.7 | 8.97 | 227.0 | 2.49 | 63.0 |
| 5/8 | 771104 | PZK-Y10-NA | 0.63 | 15.9 | 9.49 | 240.0 | 2.61 | 66.0 |
| 3/4 | 771105 | PZK-Y12-NA | 0.75 | 19.1 | 10.20 | 258.0 | 2.73 | 69.0 |
| 7/8 | 771106 | PZK-Y14-NA | 0.88 | 22.2 | 12.13 | 307.0 | 2.89 | 73.0 |
| 1-1/8 | 771107 | PZK-Y18-NA | 1.13 | 28.6 | 13.16 | 333.0 | 3.56 | 90.0 |

Note: Not UL Approved. Includes foam insulation as shown.

ZoomLock Flame-Free Refrigerant Fittings

P-Traps



Dimensions

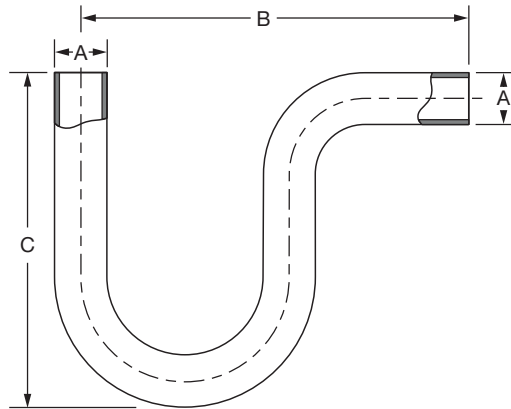

| Size | Part Number | Description | Dimensions | | | | | |
|--------|-------------|-------------|------------|------|-------|-------|------|-------|
| | | | A | | B | | C | |
| | | | Inch | mm | Inch | mm | Inch | mm |
| 1/2 | 771203 | PZK-PT8-NA | 0.50 | 12.7 | 5.12 | 130.0 | 3.54 | 90.0 |
| 5/8 | 771204 | PZK-PT10-NA | 0.63 | 15.9 | 5.12 | 130.0 | 3.62 | 92.0 |
| 3/4 | 771205 | PZK-PT12-NA | 0.75 | 19.1 | 5.91 | 150.0 | 4.25 | 108.0 |
| 7/8 | 771206 | PZK-PT14-NA | 0.88 | 22.2 | 6.69 | 170.0 | 4.65 | 118.0 |
| 1-1/8 | 771207 | PZK-PT18-NA | 1.13 | 28.6 | 8.27 | 210.0 | 5.98 | 152.0 |
| 1-3/8* | 771208 | PZK-PT22-NA | 1.38 | 34.9 | 10.24 | 260.0 | 7.48 | 190.0 |

*ZoomLock 1-3/8" fittings can only be crimped with 19 kN Klauke tools or RIDGID crimping jaws.

Note: Not UL Approved.

Coming Soon!

You will soon be able to use ZoomLock compatible RIDGID® jaws to crimp from 1/4" all the way up to 2-1/8" using one tool.



- ZoomLock RIDGID Standard Series Crimping Jaws for all ZoomLock Fittings: 1/4" to 2-1/8".
- Crimping Jaws Compatible with RIDGID Standard Series RP340 Tool (sold separately by RIDGID distributors).
- Expanding ZoomLock Fitting Offering and Jaws to 1-5/8" and 2-1/8".
- RIDGID Standard Series Jaws for Existing ZoomLock Fittings: 1/4" to 1-1/8".

Crimping Tools

Features

- Lightweight design increases productivity
- Short pressing cycle, 5-7 seconds
- Compact design and 350° jaw rotation allows technician to install in tight spaces
- Automatic piston return
- Safety feature that allows crimp cycle to be interrupted
 - Feature allows manual release of piston, if needed
- High-quality, powerful Makita Li-Ion technology for lasting, battery-powered pressing
 - 100-150 Crimps per charge
 - Short charging time of just 15 minutes (2.0 Ah)
 - Makita batteries and chargers available worldwide
- Tool service indicated via imbedded LEDs, illuminates at 10,000 cycles
- Tool Warranty is 24 months from date of purchase
- Crimp tools are not sold separately



Klauke® 19 kN MODEL MAP2L19

- Available in Tool Kit:
 - 0 Jaw Tool Kit**
PZK-TK190, P/N 770026
 - 5 Jaw Tool Kit**
PZK-TK195, P/N 770028;
- For use with KJ Series Jaws
- 8 Jaw Kit & Individual Jaws Sold Separately
- Approved Copper Tubing Types:
 - Hard Copper (Drawn)
 - 1/4" – 1-3/8" Type ACR, M, L, K
 - Soft Copper (Annealed)
 - 1/4" – 1-3/8" Type ACR, L, K

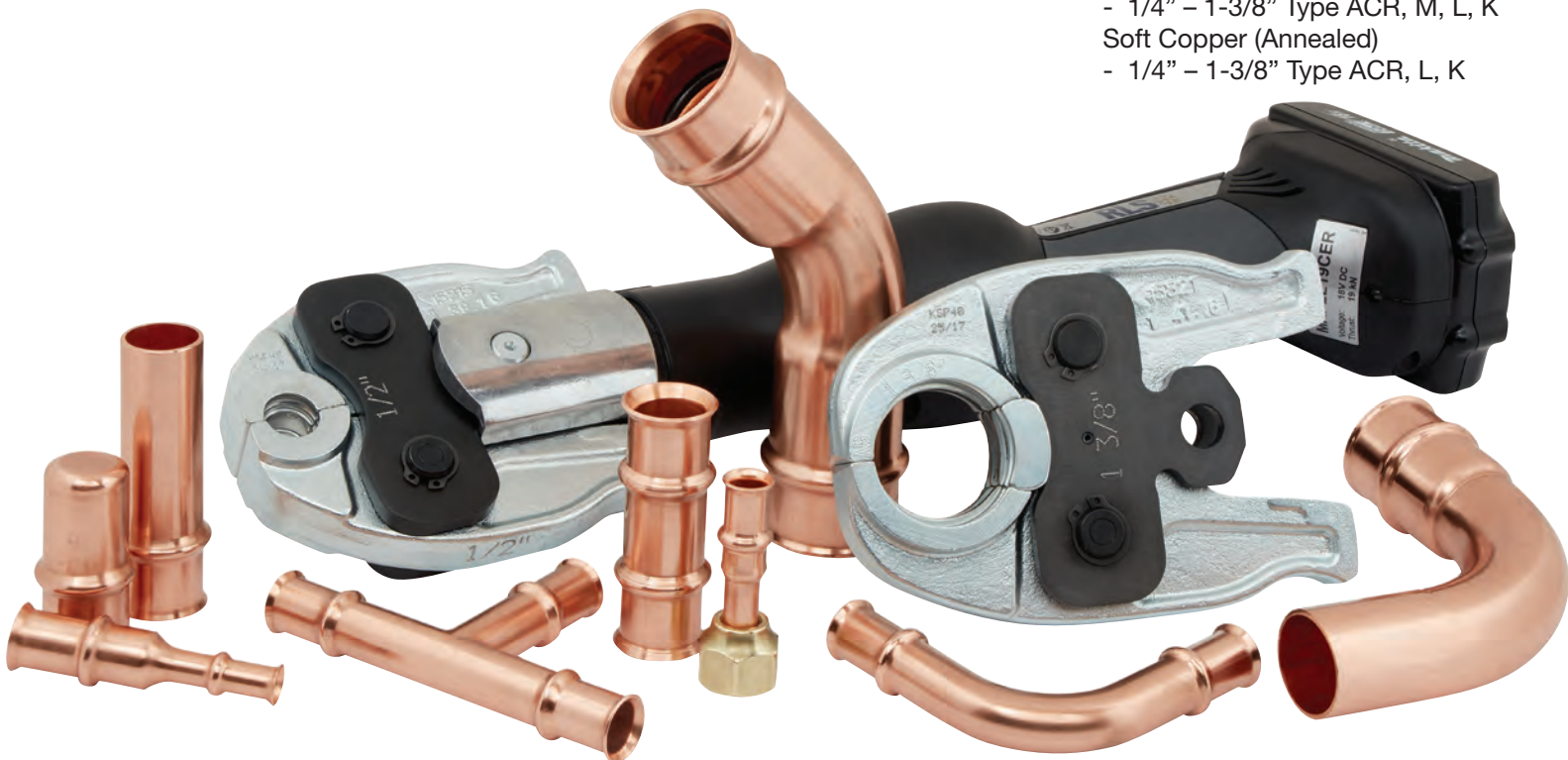

Tool Kits



0 Jaw Tool Kit

Includes a Klauke crimping tool and the tool kit contents, listed at below right.

- **Description:** PZK-TK190
- **Part Number:** 770026
- **Includes Crimping Tool:** Klauke 19 kN MAP2L19

5 Jaw Tool Kit

Includes the Klauke crimping tool, 5 jaws, and tool kit contents, listed at below right.

- **Description:** PZK-TK195
- **Part Number:** 770028
- **Jaw Sizes (Inches):** 3/8, 1/2, 5/8, 7/8, 1-1/8
- **Includes Crimping Tool:** Klauke 19 kN MAP2L19

Replacement Klauke 15 kN Tool Kit

- **Description:** PZK-TK0
- **Part Number:** 770000
- **Includes Crimping Tool:** Klauke 15 kN MAP2LCER

Replacement Klauke Empty Tool Kit Case

- **Part Number:** 770016

Jaw Kits



Klauke 8 Jaw Kits

8 piece Klauke 19 kN jaw kit in hard plastic carrying case.

- **Description:** KJ4-KJ22 Klauke
- **Part Number:** 770239 KJ Series Jaws
- **Jaw Sizes (Inches):** 1/4, 3/8, 1/2, 5/8, 3/4, 7/8, 1-1/8, 1-3/8 (5/16 jaw sold separately)
- **Compatible with Klauke Model:** 19 kN MAP2L19

8 piece Klauke 15 kN jaw kit in hard plastic carrying case.

- **Description:** J4-J18 Klauke
- **Part Number:** 770208 J Series Jaws
- **Jaw Sizes (Inches):** 1/4, 5/16, 3/8, 1/2, 5/8, 3/4, 7/8, 1-1/8
- **Compatible with Klauke Model:** 15 kN MAP2LCER



RIDGID 8 Jaw Kit

8 piece RIDGID jaw kit in hard plastic carrying case includes tube cutter, deburring tools, crimp gauge, depth gauge, stainless steel brush, abrasive pad, and permanent marker.

- **Description:** RJ4-RJ22 RIDGID
- **Part Number:** 770219 RJ Series Jaws
- **Jaw Sizes (Inches):** 1/4, 3/8, 1/2, 5/8, 3/4, 7/8, 1-1/8, 1-3/8 (5/16 jaw sold separately)
- **Compatible with RIDGID Compact Press Tool Models:** RP 240, RP 241, RP 200, RP 210, RP 100 (Sold through RIDGID distributors)

Klauke Tool Kit Contents

- Klauke Crimping Tool
- Tubing Cutter
- Deburring Tool
- RLS Crimp Gauge
- RLS Depth Gauge
- Stainless Steel Brush
- Abrasive Pad
- Permanent Marker
- Battery Charger
- (2) Lithium-Ion Rechargeable Batteries

Crimping Tools and Jaw Selection



KJ Series Jaw



**Klauke 19 kN
Crimping Tool
MAP2L19**



RJ Series Jaw



**RIDGID Compact
Press Tools*
RP 240, RP 241, RP 200,
RP 210, RP 100**

APPROVED COPPER TUBING TYPES

Hard Copper (Drawn)

1/4" – 1-3/8" Type ACR, M, L, K

Soft Copper (Annealed)

1/4" – 1-3/8" Type ACR, L, K

FEATURES

| | | |
|-------------------------------|--------------------------------------|-------------------------------------|
| Crimping Force | 19 kN | 24 kN |
| Minimum Crimp Pressure | 525 bar / 7,613 psi | Sold through RIDGID distributors |
| Number of Crimps | 2.0 Ah approx. 150 (for NS20) | |
| Battery Capacity | 18V / 2.0 Ah Li-Ion Makita (BL1820B) | |
| Charging Time | 15 minutes | |
| Operating Temp. Range | 14°F to 104°F (-10°C to 40°C) | |
| Jaw Holder | Swivels through 350° | |
| Weight with Battery | 1.8 kg (4.0 lb.) | |
| Without Jaw | 3.1 kg (6.8 lb) | |
| Dimensions | 395 x 80 x 118 mm | |
| Diagnostics | X | |
| PGA 1 Compatible | X | |
| i-press Software Compatible | X | |
| Tool Warranty | 24 months from date of purchase | |

TOOL KITS / PART NUMBER

| | | |
|------------------------|--|---|
| 0 JAW TOOL KITS | PZK-TK190 770026 | — |
| 5 JAW TOOL KITS | PZK-TK195 770028 3/8, 1/2, 5/8, 7/8, 1-1/8 | — |

* Sold through RIDGID distributors.

Crimping Tools and Jaw Selection

| | | |
|--|--|---|
|  Replacement J Series Jaw Compatible with Klauke 15kN Crimping Tool MAP2LCER |  KJ Series Jaw  Klauke 19 kN Crimping Tool MAP2L19 |  RJ Series Jaw  RIDGID Compact Press Tools* RP 240, RP 241, RP 200, RP 210, RP 100 |
|--|--|---|

JAW KITS / PART NUMBER

| | | | |
|-------------------------|--|---|---|
| 8 PIECE JAW KITS | J4-J18 770208 1/4, 5/16, 3/8, 1/2, 5/8, 3/4, 7/8, 1-1/8 | KJ4-KJ22 770239 1/4, 3/8, 1/2, 5/8, 3/4, 7/8, 1-1/8, 1-3/8 | RJ4-RJ22 770219 1/4, 3/8, 1/2, 5/8, 3/4, 7/8, 1-1/8, 1-3/8 |
| JAW CASE (EMPTY) | 770240 (8 empty slots) | | 770220 (9 empty slots) |

INDIVIDUAL JAWS/ PART NUMBER

| | | | |
|---------------|-------------------|--------------------|--------------------|
| 1/4" | PZK-J4 770200 | PZK-KJ4 770230 | PZK-RJ4 770210 |
| 5/16" | PZK-J5 770201 | PZK-KJ5 770231 | PZK-RJ5 770211 |
| 3/8" | PZK-J6 770202 | PZK-KJ6 770232 | PZK-RJ6 770212 |
| 1/2" | PZK-J8 770203 | PZK-KJ8 770233 | PZK-RJ8 770213 |
| 5/8" | PZK-J10 770204 | PZK-KJ10 770234 | PZK-RJ10 770214 |
| 3/4" | PZK-J12 770205 | PZK-KJ12 770235 | PZK-RJ12 770215 |
| 7/8" | PZK-J14 770206 | PZK-KJ14 770236 | PZK-RJ14 770216 |
| 1" | — | PZK-KJ16 770241 | — |
| 1-1/8" | PZK-J18 770207 | PZK-KJ18 770237 | PZK-RJ18 770217 |
| 1-3/8" | — | PZK-KJ22 770238 | PZK-RJ22 770218 |

* Sold through RIDGID distributors.

Replacement Parts and Accessories



Tubing Cutter

ZoomLock approved tubing cutter.

- **Description:** 1/4" to 1-1/8" Capacity Tubing Cutter
- **Part Number:** 770006



Deburring Tool

ZoomLock approved deburring tool.

- **Description:** 1/4" to 1-3/8" Capacity Tube Deburring Tool
- **Part Number:** 770007



RLS Crimp Gauge

Confirms the measurement of the finished crimp band diameter.

- **Description:** PZK-GNG1
- **Part Number:** 770005



Depth Gauge

Plastic depth gauge confirms the proper insertion depth of the tubing.

- **Description:** PZK-IDGP
- **Part Number:** 770015



Diagnostic Tool

Adaptor tool for crimping tool diagnostics. Easily connect to PC via USB-Interface. Provides statistical evaluation of average crimping process of tool. Free downloading of Software "iPress" via www.klauke.com.

- **Description:** PGA1
- **Part Number:** 770008
- **Compatible with:**
Klauke MAP2LCER
Klauke MAP2L19

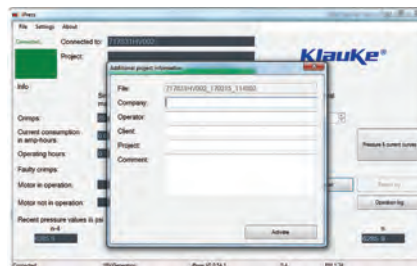

Installation Instructions

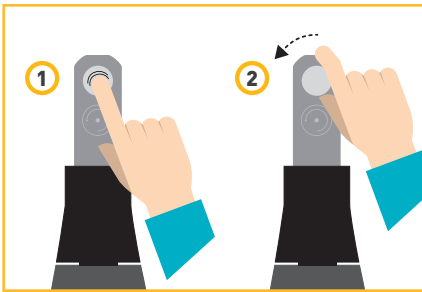

STEP 1

Press the ZoomLock Crimping Tool locking pin, then rotate 45° to release.

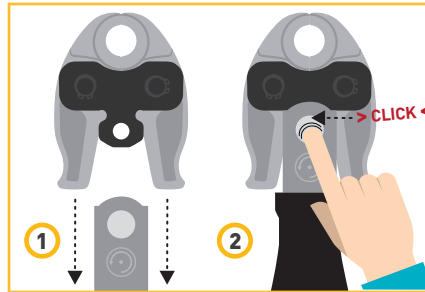

STEP 2

Slide jaws over Crimping Tool head, then depress locking pin until it clicks.



STEP 3

Slide charged battery into base of Crimping Tool. Press and hold the trigger on Crimping Tool to calibrate. **Calibration is recommended daily, prior to use.**

WARNING! COPPER TUBE ENDS SHOULD BE INSPECTED AND ANY SHARP EDGES SHOULD BE ADDRESSED. SHARP EDGES MAY CAUSE DAMAGE TO THE O-RING.

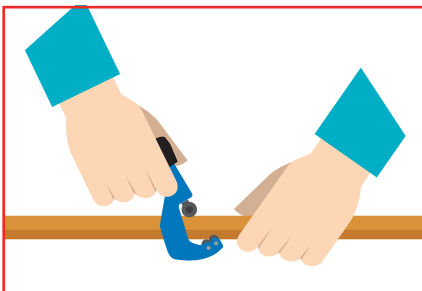

STEP 4 - CUT

Cut copper tube using the **supplied** or similar commercially available tube cutter. Verify tube cutter is properly maintained and wheel is sharp. **DO NOT** use any type of saw as this creates a sharp surface that will cut the o-ring.

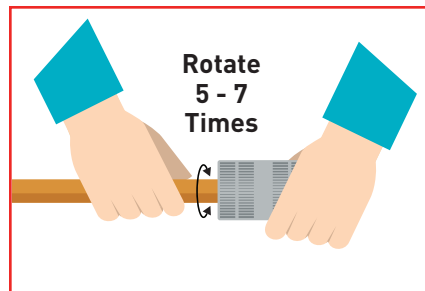

STEP 5 - DEBURR

Use supplied deburring tool. **ALL tubing MUST** have its outer diameter **deburred** prior to ZoomLock fitting installation. Rotate tool back-and-forth 5 - 7 times to remove sharp edges and burrs. **Perform this step BEFORE sanding.**

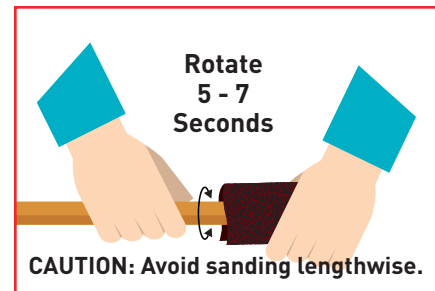

STEP 6 - SAND & CLEAN

ALL tubing must be SANDED and CLEANED. Use provided heavy duty nylon mesh abrasive pad (maroon color) or 180 grit sand cloth. **SAND tube in RADIAL DIRECTION** as shown with arrows for 5 - 7 seconds or 10 - 14 times back-and-forth. Remove residual debris from tube end.

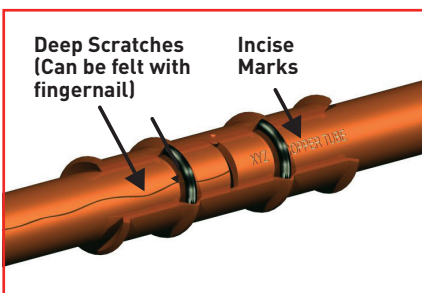

STEP 7 - INSPECT

INSPECT copper tube **AFTER** sanding. Surfaces need to appear clean and shiny. Inspect for any **VISIBLE SCRATCHES, INCISE MARKS OR OTHER TUBE DEFECTS.** Area of importance is within 1.5 inches from tube end. If scratches are present, cut off affected area and repeat Steps 4 - 7 or sand thoroughly to remove.

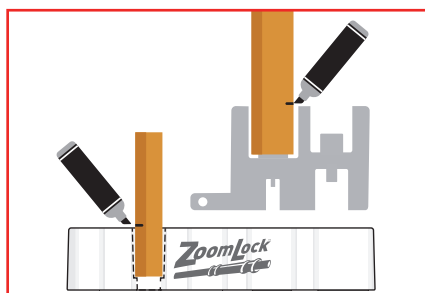

STEP 8 - MARK

Using the depth gauge provided or the chart on page 21 to determine the insertion depth. Mark the tubing with a permanent marker to indicate proper insertion depth on every tube. Two styles of gauges are shown. (Metal gauge is no longer available).

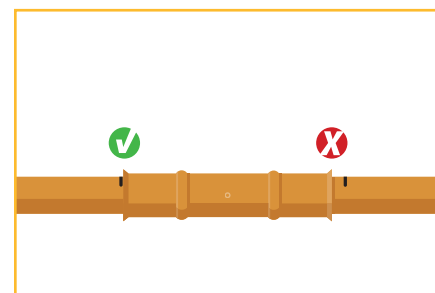

STEP 9

Push the fitting onto the tube. Use the mark to assure insertion depth and secure fit.

Installation Instructions

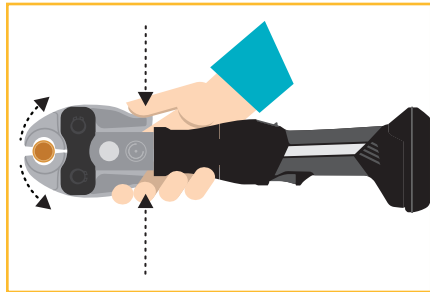

STEP 10

Open the jaws of the ZoomLock Crimping Tool.

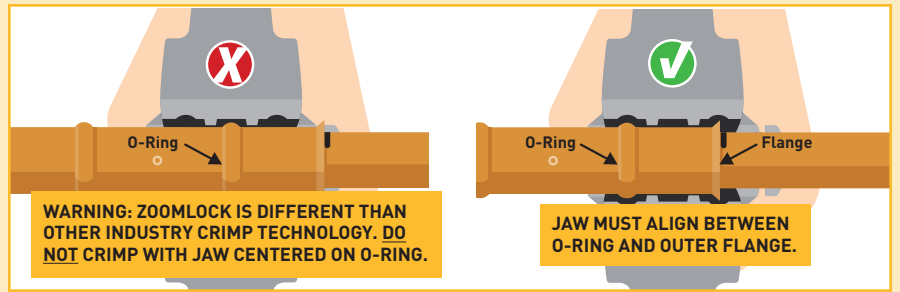

STEP 11

Properly place the crimping jaws onto the fitting. Grooves in the jaws make it easy to align. See illustration at above right for proper crimping alignment.

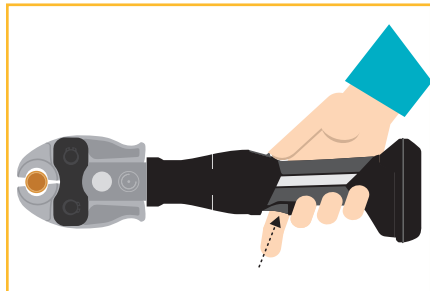

STEP 12

Press and hold the trigger on the ZoomLock Crimping Tool to begin the crimping process. Continue to hold the trigger until the ZoomLock Crimping Tool completes its cycle.

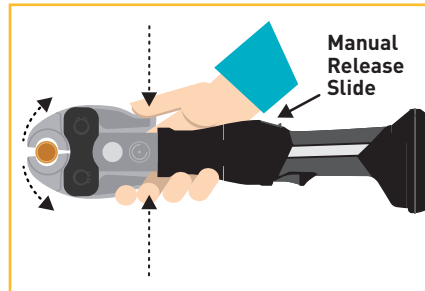

STEP 13

Open the jaws and remove from the fitting. If the jaws do not open, crimping cycle was not completed. For manual override, slide the manual release button down to open the jaw in case of emergency.

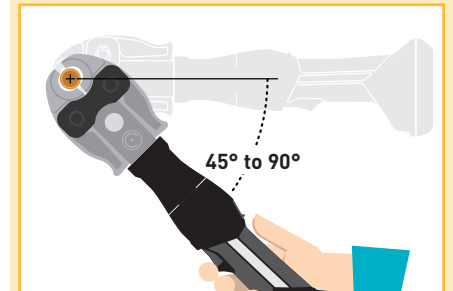

STEP 14

APPLIES TO 1-3/8" FITTINGS ONLY
Crimp 1-3/8" fitting twice, rotate crimping tool 45 to 90 degrees after first crimp and repeat crimp.

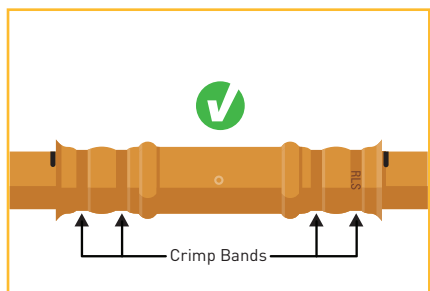

STEP 15

A special "RLS" mark will be displayed on the tube to let you know the connection is crimped properly.

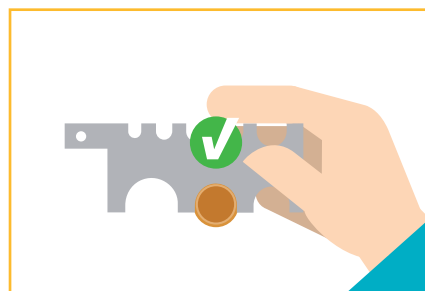

STEP 16

The supplied RLS Crimp Gauge will confirm the measurement of the finished crimp band diameter. See crimp band locations noted in Step 15. It may be necessary to rotate the gauge in order to not interfere with the copper tube flashing left from the crimping process.

WARNING!

FAILURE TO FOLLOW THE INSTALLATION INSTRUCTIONS, IMPROPER SELECTION OR IMPROPER USE OF ZOOMLOCK FITTINGS AND RELATED ACCESSORIES ("PRODUCTS") CAN CAUSE DEATH, PERSONAL INJURY AND PROPERTY DAMAGE.

Troubleshooting and Frequently Asked Questions

Troubleshooting

1. Do you have any troubleshooting suggestions if a coupling leaks after crimp?

- Verify tubing for scratches, incise marks and dents prior to tube cutting. Be careful when using a knife to cut off plastic shipping caps on copper tubes.
- Take time to cut the tubing properly using a tubing cutter. Rushing through the cutting process may cause dents and oval tubing which can create leaks.
- Verify proper deburring and sanding/cleaning of tube surface per steps 5 to 7.
- Verify proper tube insertion depth using provided insertion gauge. One gauge is provided with the tool kit or can be ordered separately. Refer to the "minimum insertion depth" table in FAQ section if you do not have a gauge.
- Verify the proper crimp diameter using the provided crimp gauge.
- Verify correct jaw is installed for the fitting you are trying to crimp.
- Try applying a light coating of spray lubricant such as WD-40 directly to the jaws.
- Let jaw and tool do the work. If the fitting is in a hard to reach place, it is important to let the tool body move freely.
- Avoid applying any sort of pulling or twisting of the tool during the crimp process.
- If the fitting was recently crimped (15 – 20 minutes) prior to pressurization, it is possible the bubbles are a result of trapped air in the double crimp area to leak out over time. This is not a joint leak and will leak out over time. This is more likely to occur on smaller fittings.

2. What can I do if the crimp gauge does not fit?

You can lubricate the jaws one time with WD-40 (or similar) along with re-crimping. Be sure to rotate the tool a few degrees.

3. My jaws sometime get stuck on the fitting after crimping. What can I do to make it easier to remove the jaws?

Applying a thin coating of WD-40 or similar lubricant to the jaws before starting a job should help.

4. If a fitting does leak, can you braze the fitting in rather than cutting out the fitting and having to make up for lost pipe?

If you find a fitting that has a refrigerant leak, try re-crimping the connection first. If that does not work, the fitting must be cut out and replaced. Trying to braze the fitting will very likely melt the o-ring material and thus introduce contaminants into the system that could cause other system issues.

Installation

5. Why is it significant that ZoomLock is "UL Listed"?

UL Listed provides approval by UL for field and factory installation. UL Recognized products limit products to being factory installations only (not field).

6. What is the #1 suggestion to ensure safety?

For you and your co-worker's protection, it is very important to use the depth and crimp gauges. You are not done installing ZoomLock fittings until you complete step 16. Jaws wear and have a 10,000 to 12,000 estimated life. Just like any mechanical device, tools can malfunction.

7. What is the #1 cause of leaky fittings?

Skipping the installation instructions 4 to 8 will cause the tube to leak. It is very important to use the scouring pad and deburr tool. Refrigerant gas at the maximum rated 700 psi pressure is more likely to leak than water at a much lower pressure, therefore, following the tube preparation instructions is very important.

8. What is considered a "deep" scratch and what can be done to clean this?

A deep scratch is defined as one that can be felt with your fingernail. Try using a new piece of Scotch Brite® abrasive pad. Alternatively, 180 grit sandpaper/cloth can be used for 15 - 20 seconds to remove a deep scratch.



Following tube preparation steps 4 to 8 is important for preventing leaks.

9. Can you show an example of a "good" copper tube surface after sanding?



Figure 1 - Copper tube with "good" surface.



Figure 2 - Copper tube with "bad" surface scratch.

Troubleshooting and Frequently Asked Questions

Figure 1 is an example of a good tube. Figure 2 is an example of a tube with a bad scratch that requires proper tube preparation. It is very important to follow deburring, sanding and inspection steps 4 to 8.

10. How do I know the correct insertion depth when pushing the ZoomLock fitting onto the copper tube?

Use the depth gauge provided or the Minimum Insertion Depth chart below to determine the correct insertion depth. Mark the tubing with a permanent marker to indicate proper insertion depth on every tube.

| MINIMUM INSERTION DEPTH | | |
|-------------------------|--------|----|
| Fitting Size | Inches | mm |
| 1/4 | 1 | 24 |
| 5/16 | 1 | 24 |
| 3/8 | 1 | 24 |
| 1/2 | 1-1/4 | 32 |
| 5/8 | 1-1/4 | 32 |
| 3/4 | 1-1/4 | 32 |
| 7/8 | 1-1/4 | 32 |
| 1 | 1-1/4 | 32 |
| 1-1/8 | 1-1/4 | 32 |
| 1-3/8 | 1-1/2 | 38 |

11. How do you slide insulation over these fittings (the flare will grab insulation).

If the flare of the fitting tends to be a problem, you can smooth the transition over the fitting by adding duct tape around the flared edge of the fitting to the tube.

12. Do you have a solution for crimping onto flared tubing like that coming out of the condenser and evaporator on residential units?

No, we do not have a specific product designed to crimp over the flared tubing. However, if there is at least 2 inches of straight copper tubing after the flared end and is accessible with the jaws, we suggest that you cut the flared end off and crimp directly to the tube.

13. How much tolerance can the ZoomLock fitting handle on the pipe being crimped?

We know that not all copper tubing is the same, but we have tested ZoomLock with most copper tube manufacturers with no issues. The tolerance for each tube to ensure a leak-free joint is defined by ASTM B280.

14. What is the minimum brazing distance?

MINIMUM DISTANCE FROM ZOOMLOCK FITTING TO BRAZE

| Tube Diameter | Inches | Millimeters |
|---------------|--------|-------------|
| 1/4 to 1/2 | 5 | 127 |
| 5/8 | 7 | 178 |
| 3/4 | 8 | 203 |
| 7/8 | 9 | 229 |
| 1 | 9 | 229 |
| 1-1/8 | 11 | 279 |
| 1-3/8 | 14 | 356 |

15. What is the minimum distance between ZoomLock fittings?

The ends of the fittings should be no closer than 1/4 inch apart.

16. What is the recommended minimum space (envelope) needed around the Klauke tool and jaws to crimp?

The envelope of 11" x 7" is recommended around fittings. The illustration below shows closed space around the fitting with one end open. It assumes a 4" centerline between fittings and a max 1-3/8" couplings. A minimum of 2.25" from the back wall surface is required. You need 2-1/2" between couplings for jaws if the tool is coming up from below the fittings to crimp. We realize there are many configurations, so please contact your local Parker sales engineer with any questions.

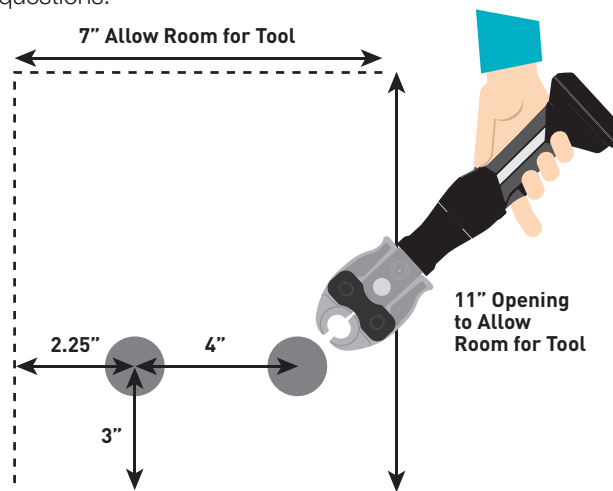

17. What can I use to make inserting larger copper tubes into the Zoomlock fittings easier?

Larger size tubing such 1-1/8" or 1-3/8" can be more difficult to slide into the fitting since there is large surface area. Any of the following lubricants can be used to aid in the tube insertion: Parker O-Lube, Nylog Blue or POE oil.

Troubleshooting and Frequently Asked Questions

Crimp Tool

18. Can ZoomLock be crimped in the same location as Viega ProPress fittings?

No. The fittings will leak if you do not crimp per step 11 of the installation instructions. Proper crimping is also illustrated in the photo below.

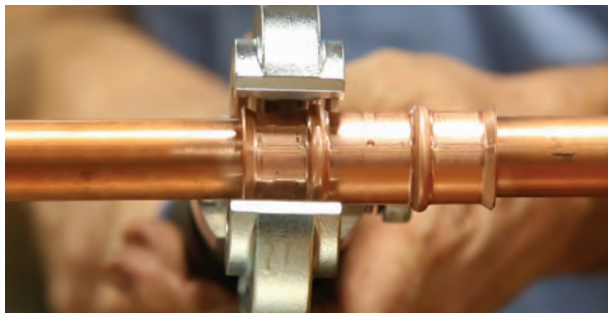

19. How many crimps can you complete on a complete battery charge?

On average you can achieve 100-150 crimps per charge depending on the size fittings being crimped. Each Klauke Tool kit comes with 2 Makita Lithium-ion 2.0 Ah 18V batteries (BL1820B) and a rapid charge charging system. To prevent any downtime, it is recommended that you have both batteries charged before going to the job site and to have one charging while the other is in use.

20. How can I increase the number of crimps and battery life?

You can purchase a Makita 3.0 Ah 18 V Li-Ion battery (BL1930). Parker does not sell these, but they can be purchased at your local or online retailers wherever batteries are sold.

21. How do you know when the tool needs to be serviced?

The 15 kN (MAP2L) and 19 kN MAP2L19 Klauke tools have red LED lights on the back of the tool that will blink for 20 seconds after a crimp. The 19 kN MAP219 tool has a screen on the tool which indicates the number of remaining crimps. Take the tool back to an authorized dealer to have the tool serviced.

22. What is the expected life of the jaws?

Each jaw has an expected life of 10,000 to 12,000 crimps. Both the Klauke and RIDGID brand jaws are designed to safely crack at their end of life, so you should keep track of your approximate usage. The plate connecting the two RIDGID jaw halves is designed to crack at end of life. The casting itself on the Klauke jaw is designed to crack at end of life.

23. How do you know when the jaw needs to be replaced?

You will know when the jaw needs to be replaced when the contact point between the upper and lower jaw

starts to open up/widen. A good indication of failure is when the crimp gauge no longer engages. Use the supplied wire brush in tool kit to periodically clean pressing jaws.

24. Where can replacement batteries and chargers be purchased?

The 2.0 Ah 18 V Makita Li-Ion battery (BL1820B) along with the 110V AC charger (DC18RC) can be purchased at your local or online retailers wherever batteries are sold.

Technical

25. What material is the o-ring made of?

The o-ring is a highly engineered HNBR Parker o-ring that has been used in HVAC applications by OEMs and suppliers for many years with no issues.

26. What is the expected life of the o-ring in the system?

The expected life of the o-ring that stays within the product specifications for temperature and pressure should be 30 years.

27. Does the o-ring compensate for imperfections in the piping to make a tight seal?

Yes, the o-ring does compensate for small/minor scratches on the surface of the tube; however, the tubing needs to be inspected prior to use per ASTM B280 and the Copper Tube Handbook published by the Copper Development Association (CDA) specifications. Imperfections in and adjacent to the crimp area could inhibit the joint integrity. These imperfections may include surface scratches, incise marks, and tubing out of round.

28. Are there any shelf life concerns?

No, the shelf life of the product is estimated at or above 30 years.

29. Is there a concern about ice building up and then thawing under fitting in a horizontal or vertical configuration?

No, ZoomLock has been thoroughly tested in freeze/thaw applications with over 10,000 cycles completed in both vertical and horizontal configurations with no leakage concerns.

30. Are there any concerns with corrosion due to coastal applications, cleaning agents, or off-gassing of produce/vegetables?

No, ZoomLock has gone through a battery of corrosion testing, completing over 2,000 hours of salt spray testing without failure, which proves the resilience of the product.

Troubleshooting and Frequently Asked Questions

31. The product specifications state that the application temperature limits are -40°F to +300°F / -40°C to 150°C. What happens if we go beyond that limit?

If the application that the fitting is being used in goes beyond the specified limits of the o-ring (-40°F to +300°F / -40°C to 150°C) then there will be an increased likelihood that a leak can occur.

32. Can I use ZoomLock in a transportation application where fitting vibration is high?

Yes, ZoomLock has gone through extensive vibration testing and results are actually better than that of a braze joint. Please review the vibration testing procedure and conclusion for more information.

33. Can you use ZoomLock to crimp to aluminum, steel, or stainless steel?

No, ZoomLock is specifically designed for copper to copper connections. Connecting to dissimilar metals can cause formicary corrosion issues that could cause a failure.

34. Is it OK if ZoomLock fittings rotate?

Yes, but only if the crimps were checked with the supplied crimp gauge. Since Zoomlock fittings are crimped concentrically with the tube, approximately 5 to 10 degrees of rotation can be observed depending on the copper tube tolerances. However, one should not purposely try rotating the joint since there is a risk of damaging the o-ring. The burst strength of the joint (>2,100 psi) is still good and will not leak.

Other

35. Is ZoomLock approved by state and city building codes?

ZoomLock has been approved by UL-207, ASHRAE 15, International Code Council – Evaluation Service (ICC-ES), International Mechanical Code (IMC), Universal Mechanical Code (UMC), and International Residential Code (IRC). These approvals are all that is needed in most areas. Please contact your local building inspector with questions prior to install.

36. Can systems with ZoomLock fittings be retrofitted with lower GWP refrigerants?

Yes, but refer to the table below for guidance. Your system must be using one of the higher GWP refrigerants listed in the “baseline” section. Your lower GWP refrigerant options are listed in the “retrofit refrigerants” section.

Baseline Refrigerants

Can be replaced with ▶

- R134a
- R404A
- R422A/D
- R424A
- R507A

Retrofit Refrigerants

- R407A/C/F/H
- R448A
- R449A/B
- R450A
- R452A
- R513A/B
- R1234yf
- R1234ze(E)



Performance Data

ACR Pressure Drop (10 ft. long)

3/8" ACR Tube Pressure Drop vs. Velocity

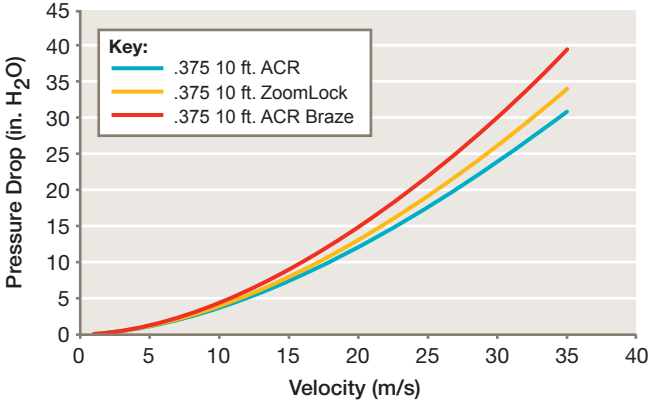

ACR Loss Coefficient

3/8" ACR Tube Loss Coefficient vs. Reynolds Number

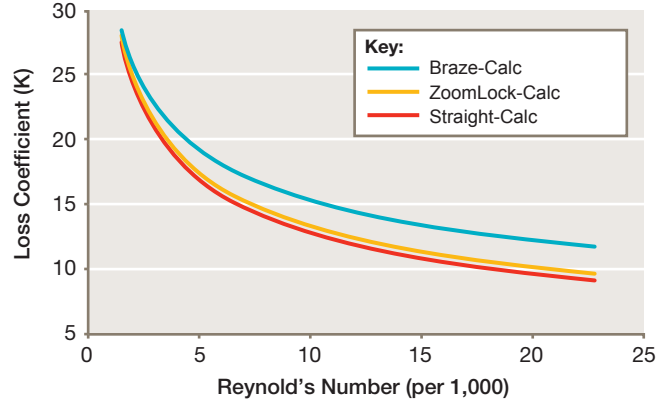

3/4" ACR Tube Pressure Drop vs. Velocity

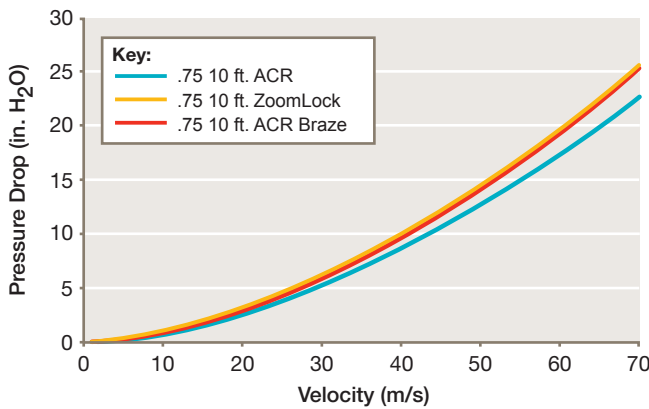

3/4" ACR Tube Loss Coefficient vs. Reynolds Number

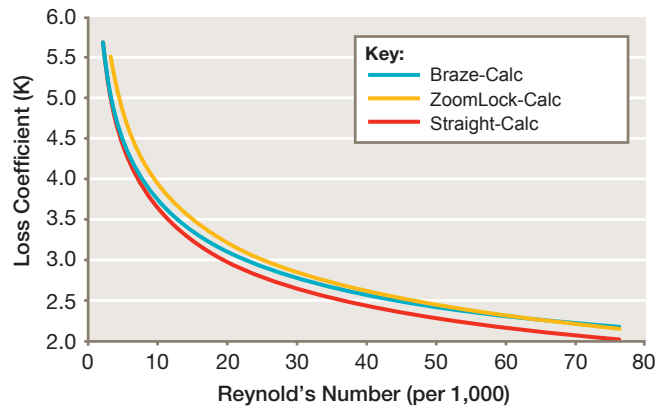

7/8" ACR Tube Pressure Drop vs. Velocity

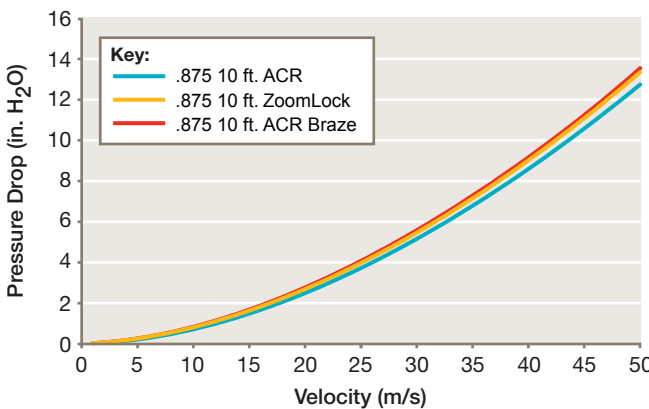

7/8" ACR Tube Loss Coefficient vs. Reynolds Number

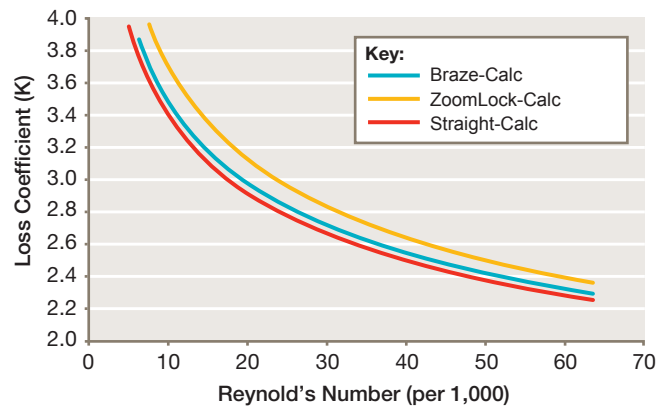

ICC-ES Evaluation Report



Effective Date: January 2018

Revision Date: December 18, 2017

This report subject to renewal in January 2019.

PMG-1296

CSI: DIVISION: 23 00 00—HEATING, VENTILATING AND AIR CONDITIONING (HVAC)
Section: 23 20 00—HVAC Pipe and Fittings

Product certification system:

The ICC-ES product certification system includes testing samples taken from the market or supplier's stock, or a combination of both, to verify compliance with applicable codes and standards. The system also involves factory inspections, and assessment and surveillance of the supplier's quality system.

Products: Refrigeration Tubing Connectors

Listee: RLS, LLC
101 S. Douglas Street
Shelbina, MO 63468
www.rlspressfittings.com

Additional Listee:

Parker Sporlan
206 Lange Drive
Washington, MO 63090
www.parker.com

Compliance with the following codes:

2018, 2015, 2012, 2009 and 2006 *International Mechanical Code*® (IMC)
2018, 2015, 2012, 2009 and 2006 *International Residential Code*® (IRC)
2015, 2012, 2009 and 2006 *Uniform Mechanical Code*® (UMC)*

**Copyrighted publication of the International Association of Plumbing and Mechanical Officials.*

Compliance with the following standards:

UL 207 (Edition 8), Standard for Refrigerant-Containing Components and Accessories, Nonelectrical

Identification:

The refrigerant tubing connectors shall be legibly and permanently marked with the manufacturer's name, trade name, trademark, or identifying symbol or other descriptive marking by which the organization responsible for the product may be identified.

The shipping carton, a separate instruction sheet included with the shipping carton or a tag attached to the component shall include a distinctive model, part number, or type designation for the connector and include information for each refrigerant type for which the connector is intended and the ICC-ES PMG listing mark.

Installation:

The refrigerant tubing connectors must be installed in accordance with the manufacturer's published installation instructions, the applicable codes and this listing.

Mechanical joints shall not be used on annealed temper copper tube in sizes larger than 7/8-inch (22.2 mm) OD size per IMC and 3/4" of an inch nominal size per UMC.

Note: The 2018 IMC and IRC permit for press-connect joints listed for refrigeration piping.

Models:

The refrigerant tubing connectors are intended for connection of copper, aluminum, titanium and other types of tubing approved by the manufacturer. The connection is accomplished by compressing (solder-free) the fitting to a pipe. The refrigerant connectors are only suitable with the following refrigerants (R32, R134A, R143A, R290, R404A, R407, R410A, R417A, R421A, R422, R424A, R427A, R434A, R437A, R433A, R445A, R446A, R447A, R448A, R449, R450A, R451, R452, R453A, R454, R455A, R456A, R507, R513, R600, R600a, R718, R1234yf, R1234ze, Ethylene Glycol).

ICC-ES Evaluation Report

Serial Model Name: RLS™ Cu

| Type of Connector | Sizes (Inches) |
|--------------------|--|
| Couplings | 1/4, 5/16, 3/8, 1/2, 5/8, 3/4, 7/8, 1, 1-1/8, 1-1/4, 1-3/8 |
| Slip Couplings | 1/4, 5/16, 3/8, 1/2, 5/8, 3/4, 7/8, 1-1/8, 1-3/8 |
| Long Radius 90° | 1/4, 5/16, 3/8, 1/2, 5/8, 3/4, 7/8, 1, 1-1/8, 1-1/4, 1-3/8 |
| Long Radius 45° | 1/4, 5/16, 3/8, 1/2, 5/8, 3/4, 7/8, 1-1/8, 1-3/8 |
| Street 90° | 1/4, 3/8, 1/2, 5/8, 3/4, 7/8, 1-1/8, 1-3/8 |
| Stubs | 1/4, 5/16, 3/8, 1/2, 5/8, 3/4, 7/8, 1-1/8, 1-3/8 |
| Reducers (F x F) | 1-3/8 x 1-1/8, 1-3/8 x 7/8, 1-1/8 x 7/8, 1-1/8 x 3/4, 1-1/8 x 5/8, 1-1/8 x 1/2, 1 x 7/8, 7/8 x 3/4, 7/8 x 5/8, 7/8 x 1/2, 3/4 x 5/8, 3/4 x 1/2, 5/8 x 1/2, 5/8 x 3/8, 5/8 x 1/4, 1/2 x 3/8, 1/2 x 1/4, 3/8 x 1/4, 5/16 x 1/4, 11mm x 3/8 |
| Tees | 1/4, 5/16, 3/8, 1/2, 5/8, 3/4, 7/8, 1, 1-1/8, 1-1/4, 1-3/8 |
| Bushing (B x F) | 1-3/8 x 1-1/8, 1-1/8 x 7/8, 7/8 x 3/4, 3/4 x 1/2, 5/8 x 1/2, 1/2 x 3/8 |
| Cap | 1/4, 5/16, 3/8, 1/2, 5/8, 3/4, 7/8, 1, 1-1/8, 1-1/4, 1-3/8 |
| SAE (Euro) Flare | 1/4, 3/8, 1/2, 5/8, 3/4 |
| Capillary Coupling | 0.072 x 1/4, 0.109 x 1/4 |
| Return Bend | 1/4, 5/16, 3/8, 1/2, 5/8, 3/4, 7/8, 1-1/8 |

Ratings:

| Sizes | Design Pressure, psig | Maximum Abnormal Pressure, psi | Continuous Operating Temperature |
|------------|-----------------------|--------------------------------|----------------------------------|
| 1/4" RLS | 700 | 700 | 250°F (121°C) |
| 5/16" RLS | 700 | 700 | 250°F (121°C) |
| 3/8" RLS | 700 | 700 | 250°F (121°C) |
| 1/2" RLS | 700 | 700 | 250°F (121°C) |
| 3/4" RLS | 700 | 700 | 250°F (121°C) |
| 5/8" RLS | 700 | 700 | 250°F (121°C) |
| 7/8" RLS | 700 | 700 | 250°F (121°C) |
| 1-1/8" RLS | 700 | 700 | 250°F (121°C) |
| 1-3/8" RLS | 700 | 700 | 250°F (121°C) |

Conditions of Listing:

- The refrigerant tubing connectors must be used with only the following refrigerants (R32, R134A, R143A, R290, R404A, R407, R410A, R417A, R421A, R422, R424A, R427A, R434A, R437A, R433A, R445A, R446A, R447A, R448A, R449, R450A, R451, R452, R453A, R454, R455A, R456A, R507, R513, R600, R600a, R718, R1234yf, R1234ze, Ethylene Glycol).
- Mechanical joints shall not be used on annealed temper copper tube in sizes larger than 7/8 inch (22.2 mm) OD size per IMC and 3/4 of an inch nominal size per UMC.
- The installation must be pressure-tested for leaks in the presence of the code official or the code official's designated representative.
- When installation is in fire-resistance-rated assemblies, evidence must be provided to the code official of compliance with *International Building Code*® (IBC) Section 713 (penetrations), *Uniform Building Code* (UBC) Section 709 (walls and partitions) or UBC Section 710 (floor/ceiling or roof/ceiling), as applicable.
- The connectors must not be used as a source of electrical ground.
- When the system is embedded in concrete, tubing must be covered a minimum of 3/4 inch (19.1 mm) and installation must comply with IBC Section 1906.3 or UBC Section 1906.3, as applicable.
- The refrigerant tubing connectors is manufactured by Cerro Flow Products, LLC in Shelbina, Missouri, under a quality control program with surveillance inspectors annually by ICC-ES.

Helium Leak Test Report



1250 Arthur E Adams Dr., Columbus, OH 43221

LAB SERVICES

Helium Leak Test Report

page 1 of 2

Customer: Marmon Refrigeration Technologies

Project No.: 12866CSL-01

Equipment: Veeco MS-40

Date Reported: January 10, 2013

Project Engineer: Jim Busch

Principal Tech: Barb Christel

Scope: To test and report the leak rate of RLS press connections.

Background: Marmon Refrigeration Technologies (MRT) submitted RLS™ press connection samples for helium leak testing. Six (6) different RLS™ sizes were chosen to connect commercially available ACR tubing (see Table 1). Thirty (30) union connections were chosen as a sample lot with two (2) connections per fitting. Each sample connected two pieces of tubing approximately nine (9) inches long. One of the tubes was brazed shut at one end and the other tube was reduced to a ¼" tube stub.

Table 1. Tube Diameters Tested

| Tube O.D. (in) | # of Samples | Total # of Tested Connections | Notes |
|-------------------|-----------------|----------------------------------|---|
| 0.250 | 30 | 60 | Samples were made from commercially available ACR tubing (soft) |
| 0.313 | 30 | 60 | |
| 0.375 | 30 | 60 | |
| 0.750 | 30 | 60 | |
| 0.875 | 30 | 60 | |
| 1.125 | 30 | 60 | |

EWI Leak Testing Approach: Prior to testing each lot of samples, the Veeco MS-40 helium leak tester was calibrated. After calibration, a solid ¼" dowel was tested to verify the integrity of the seals on the helium leak test fixture.

The ¼" tube stub was wiped down with methanol and connected to the leak detector via a Swagelok ¼" Ultra-Torr vacuum fitting (see Figure 1). Each sample was pumped down to a level of approximately 500 millitorr prior to applying helium gas near the RLS™ crimp joint (at atmospheric pressure). The helium leak rate was measured and recorded for each of the sixty (60) connections in a thirty (30) piece sample lot.

Helium Leak Test Report



1250 Arthur E Adams Dr., Columbus, OH 43221

LAB SERVICES

Helium Leak Test Report

page 2 of 2

Customer: Marmon Refrigeration Technologies

Project No.: 12866CSL-01

Equipment: Veeco MS-40

Date Reported: January 10, 2013

Project Engineer: Jim Busch

Principal Tech: Barb Christel



Figure 1. Test Set-up

Results: The maximum leak rate of all connections is summarized in Table 2. The maximum leak rate detected was 5.40E-09 std.cc/sec.

Table 2. Maximum Leak Rate per Lot

| Tube O.D. (in) | Maximum Helium Leak std.cc/sec |
|-------------------|-----------------------------------|
| 0.250 | 4.00E-10 |
| 0.313 | 6.10E-10 |
| 0.375 | 1.30E-09 |
| 0.750 | 5.20E-09 |
| 0.875 | 5.40E-09 |
| 1.125 | 3.00E-10 |

Reported by: Brad Nagy

Signature: *Brad Nagy*

Title: Manager, Weld & Test Labs

Time and Motion Study

Conducted by:

Jay Peters, Principal Advisor, Codes and Standards International

Methodology

A time study was conducted in a controlled environment, with two stations set up for joining refrigeration tube: one by brazing and one by using ZoomLock flame-free fittings. Two different installers were used, one very experienced in making brazed connections and one very experienced in using the ZoomLock press tool.

The two installers were timed independently making connections using various sized copper tube and fittings. Before timing began, tube was cut to length and the ends were prepared for connection (as these procedures are the same for both connection methods). Three connections were timed for each size of tube/fitting for each installer, and the three times were averaged. The results are shown in the table below.

LABOR TIME FOR INSTALLING A COPPER COUPLING

| Fitting Size | 1/4" | 5/8" | 1-1/8" |
|-----------------------------|------------|------------|--------------|
| Brazed Connection | 35 seconds | 42 seconds | 1:15 minutes |
| ZoomLock Braze-Free Fitting | 24 seconds | 24 seconds | 25 seconds |
| % Time Savings | 31% | 43% | 77% |

Key Findings and Conclusions

The time savings achieved while joining tube using ZoomLock flame-free fittings, compared to brazed connections, ranged from 31% on the smallest fittings timed to 77% on the largest. The average time savings over the fitting sizes timed was approximately 50%. So, on average, ZoomLock flame-free fittings were made in roughly half the time of brazing — and in less than one-quarter the time on the largest fitting size.

Based on the study, brazed connections take longer to complete than ZoomLock flame-free fittings. When analyzing the installation techniques for both connections, a brazed connection requires a period of time to raise the temperature of the fitting and tube to about 1000°F (538°C). As the tubing and fitting increases in diameter, the amount of time it takes to heat them also increases. The ZoomLock flame-free fittings only require the connection of a press connect tool, which takes less than ten seconds to complete the actual pressing operation (two crimps) — and the time to connect does not increase significantly as the diameter of tubing and fittings increase in size.

In a controlled environment, such as the work station where the time study was conducted, the brazing operation takes less time than a similar joint made on a construction or repair project in the field. The controlled environment is already set up for brazing, with all necessary equipment and materials close at hand. However, using the ZoomLock press tool and fittings require approximately the same amount of time in any environment. Therefore, it can be assumed that the ZoomLock time savings would be even greater outside of a controlled environment.

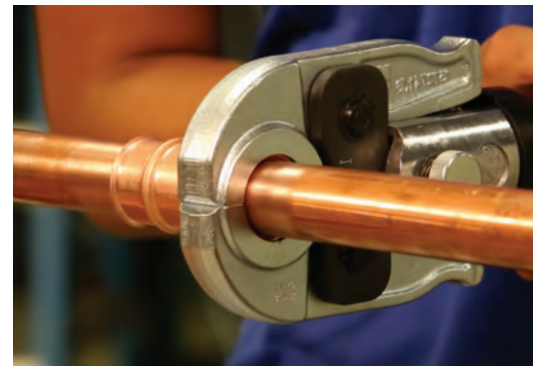
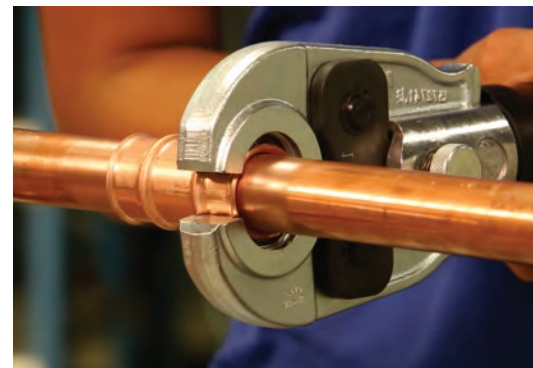
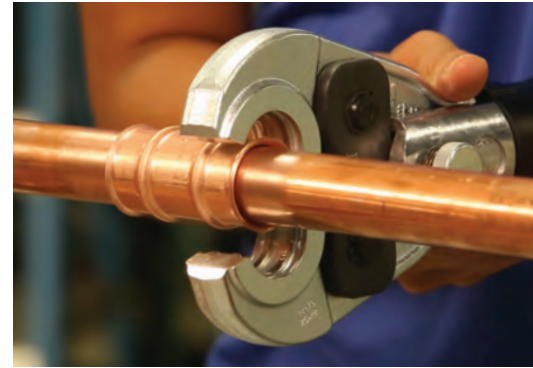

OFFER OF SALE

The items described in this document and other documents and descriptions provided by Parker Hannifin Corporation, its subsidiaries and its authorized distributors ("Seller") are hereby offered for sale at prices to be established by Seller. This offer and its acceptance by any customer ("Buyer") shall be governed by all of the following Terms and Conditions. Buyer's order for any item described in its document, when communicated to Seller verbally, or in writing, shall constitute acceptance of this offer. All goods or work described will be referred to as "Products".

1. **Terms and Conditions.** Seller's willingness to offer Products, or accept an order for Products, to or from Buyer is expressly conditioned on Buyer's assent to these Terms and Conditions and to the terms and conditions found on-line at www.parker.com/saleterms/. Seller objects to any contrary or additional term or condition of Buyer's order or any other document issued by Buyer.

2. **Price Adjustments; Payments.** Prices stated on the reverse side or preceding pages of this document are valid for 30 days. After 30 days, Seller may change prices to reflect any increase in its costs resulting from state, federal or local legislation, price increases from its suppliers, or any change in the rate, charge, or classification of any carrier. The prices stated on the reverse or preceding pages of this document do not include any sales, use, or other taxes unless so stated specifically. Unless otherwise specified by Seller, all prices are F.O.B. Seller's facility, and payment is due 30 days from the date of invoice. After 30 days, Buyer shall pay interest on any unpaid invoices at the rate of 1.5% per month or the maximum allowable rate under applicable law.

3. **Delivery Dates; Title and Risk; Shipment.** All delivery dates are approximate and Seller shall not be responsible for any damages resulting from any delay. Regardless of the manner of shipment, title to any products and risk of loss or damage shall pass to Buyer upon tender to the carrier at Seller's facility (i.e., when it's on the truck, it's yours). Unless otherwise stated, Seller may exercise its judgment in choosing the carrier and means of delivery. No deferral of shipment at Buyers' request beyond the respective dates indicated will be made except on terms that will indemnify, defend and hold Seller harmless against all loss and additional expense. Buyer shall be responsible for any additional shipping charges incurred by Seller due to Buyer's changes in shipping, product specifications or in accordance with Section 13, herein.

4. **Warranty.** Seller warrants that the Products sold hereunder shall be free from defects in material or workmanship for a period of five years from the date of delivery to Buyer. This warranty is made only to Buyer and does not extend to anyone to whom Products are sold after purchased from Seller. The prices charged for Seller's products are based upon the exclusive limited warranty stated above, and upon the following disclaimer: **DISCLAIMER OF WARRANTY: THIS WARRANTY COMPRISES THE SOLE AND ENTIRE WARRANTY PERTAINING TO PRODUCTS PROVIDED HEREUNDER. SELLER DISCLAIMS ALL OTHER WARRANTIES, EXPRESS AND IMPLIED, INCLUDING MERCHANTABILITY AND FITNESS FOR A PARTICULAR PURPOSE.**

5. **Claims; Commencement of Actions.** Buyer shall promptly inspect all Products upon delivery. No claims for shortages will be allowed unless reported to the Seller within 10 days of delivery. No other claims against Seller will be allowed unless asserted in writing within 60 days after delivery or, in the case of an alleged breach of warranty, within 30 days after the date within the warranty period on which the defect is or should have been discovered by Buyer. Any action based upon breach of this agreement or upon any other claim arising out of this sale (other than an action by Seller for any amount due to Seller from Buyer) must be commenced within thirteen months from the date of tender of delivery by Seller or, for a cause of action based upon an alleged breach of warranty, within thirteen months from the date within the warranty period on which the defect is or should have been discovered by Buyer.

6. **LIMITATION OF LIABILITY.** UPON NOTIFICATION, SELLER WILL, AT ITS OPTION, REPAIR OR REPLACE A DEFECTIVE PRODUCT, OR REFUND THE PURCHASE PRICE. **IN NO EVENT SHALL SELLER BE LIABLE TO BUYER FOR ANY SPECIAL, INDIRECT, INCIDENTAL OR CONSEQUENTIAL DAMAGES ARISING OUT OF, OR AS THE RESULT OF, THE SALE, DELIVERY, NON-DELIVERY, SERVICING, USE OR LOSS OF USE OF THE PRODUCTS OR ANY PART THEREOF, OR FOR ANY CHARGES OR EXPENSES OF ANY NATURE INCURRED WITHOUT SELLER'S WRITTEN CONSENT, EVEN IF SELLER**

HAS BEEN NEGLIGENT, WHETHER IN CONTRACT, TORT OR OTHER LEGAL THEORY. IN NO EVENT SHALL SELLER'S LIABILITY UNDER ANY CLAIM MADE BY BUYER EXCEED THE PURCHASE PRICE OF THE PRODUCTS.

7. **Contingencies.** Seller shall not be liable for any default or delay in performance if caused by circumstances beyond the reasonable control of Seller.

8. **User Responsibility.** The user, through its own analysis and testing, is solely responsible for making the final selection of the system and Product and assuring that all performance, endurance, maintenance, safety and warning requirements of the application are met. The user must analyze all aspects of the application and follow applicable industry standards and Product information. If Seller provides Product or system options, the user is responsible for determining that such data and specifications are suitable and sufficient for all applications and reasonably foreseeable uses of the Products or systems.

9. **Loss to Buyer's Property.** Any designs, tools, patterns, materials, drawings, confidential information or equipment furnished by Buyer or any other items which become Buyer's property, may be considered obsolete and may be destroyed by Seller after two consecutive years have elapsed without Buyer placing an order for the items which are manufactured using such property. Seller shall not be responsible for any loss or damage to such property while it is in Seller's possession or control.

10. **Special Tooling.** A tooling charge may be imposed for any special tooling, including without limitation, dies, fixtures, molds and patterns, acquired to manufacture Products. Such special tooling shall be and remain Seller's property notwithstanding payment of any charges by Buyer. In no event will Buyer acquire any interest in apparatus belonging to Seller which is utilized in the manufacture of the Products, even if such apparatus has been specially converted or adapted for such manufacture and notwithstanding any charges paid by Buyer. Unless otherwise agreed, Seller shall have the right to alter, discard or otherwise dispose of any special tooling or other property in its sole discretion at any time.

11. **Buyer's Obligation; Rights of Seller.** To secure payment of all sums due or otherwise, Seller shall retain a security interest in the goods delivered and this agreement shall be deemed a Security Agreement under the Uniform Commercial Code. Buyer authorizes Seller as its attorney to execute and file on Buyer's behalf all documents Seller deems necessary to perfect its security interest. Seller shall have a security interest in, and lien upon, any property of Buyer in Seller's possession as security for the payment of any amounts owed to Seller by Buyer.

12. **Improper use and Indemnity.** Buyer shall indemnify, defend, and hold Seller harmless from any claim, liability, damages, lawsuits, and costs (including attorney fees), whether for personal injury, property damage, patent, trademark or copyright infringement or any other claim, brought by or incurred by Buyer, Buyer's employees, or any other person, arising out of: (a) improper selection, improper application or other misuse of Products purchased by Buyer from Seller; (b) any act or omission, negligent or otherwise, of Buyer; (c) Seller's use of patterns, plans, drawings, or specifications furnished by Buyer to manufacture Product; or (d) Buyer's failure to comply with these terms and conditions. Seller shall not indemnify Buyer under any circumstance except as otherwise provided.

13. **Cancellations and Changes.** Orders shall not be subject to cancellation or change by Buyer for any reason, except with Seller's written consent and upon terms that will indemnify, defend and hold Seller harmless against all direct, incidental and consequential loss or damage. Seller may change product features, specifications, designs and availability with notice to Buyer.

14. **Limitation on Assignment.** Buyer may not assign its rights or obligations under this agreement without the prior written consent of Seller.

15. **Entire Agreement.** This agreement contains the entire agreement between the Buyer and Seller and constitutes the final, complete and exclusive expression of the terms of the agreement. All prior

or contemporaneous written or oral agreements or negotiations with respect to the subject matter are herein merged.

16. **Waiver and Severability.** Failure to enforce any provision of this agreement will not waive that provision nor will any such failure prejudice Seller's right to enforce that provision in the future. Invalidation of any provision of this agreement by legislation or other rule of law shall not invalidate any other provision herein. The remaining provisions of this agreement will remain in full force and effect.

17. **Termination.** This agreement may be terminated by Seller for any reason and at any time by giving Buyer thirty (30) days written notice of termination. In addition, Seller may by written notice immediately terminate this agreement for the following: (a) Buyer commits a breach of any provision of this agreement (b) the appointment of a trustee, receiver or custodian for all or any part of Buyer's property (c) the filing of a petition for relief in bankruptcy of the other Party on its own behalf, or by a third party (d) an assignment for the benefit of creditors, or (e) the dissolution or liquidation of the Buyer.

18. **Governing Law.** This agreement and the sale and delivery of all Products hereunder shall be deemed to have taken place in and shall be governed and construed in accordance with the laws of the State of Ohio, as applicable to contracts executed and wholly performed therein and without regard to conflicts of laws principles. Buyer irrevocably agrees and consents to the exclusive jurisdiction and venue of the courts of Cuyahoga County, Ohio with respect to any dispute, controversy or claim arising out of or relating to this agreement. Disputes between the parties shall not be settled by arbitration unless, after a dispute has arisen, both parties expressly agree in writing to arbitrate the dispute.

19. **Indemnity for Infringement of Intellectual Property Rights.** Seller shall have no liability for infringement of any patents, trademarks, copyrights, trade dress, trade secrets or similar rights except as provided in this Section. Seller will defend and indemnify Buyer against allegations of infringement of U.S. patents, U.S. trademarks, copyrights, trade dress and trade secrets ("Intellectual Property Rights"). Seller will defend at its expense and will pay the cost of any settlement or damages awarded in an action brought against Buyer based on an allegation that a Product sold pursuant to this Agreement infringes the Intellectual Property Rights of a third party. Seller's obligation to defend and indemnify Buyer is contingent on Buyer notifying Seller within ten (10) days after Buyer becomes aware of such allegations of infringement, and Seller having sole control over the defense of any allegations or actions including all negotiations for settlement or compromise. If a Product is subject to a claim that it infringes the Intellectual Property Rights of a third party, Seller may, at its sole expense and option, procure for Buyer the right to continue using the Product, replace or modify the Product so as to make it noninfringing, or offer to accept return of the Product and return the purchase price less a reasonable allowance for depreciation. Notwithstanding the foregoing, Seller shall have no liability for claims of infringement based on information provided by Buyer, or directed to Products delivered hereunder for which the designs are specified in whole or part by Buyer, or infringements resulting from the modification, combination or use in a system of any Product sold hereunder. The foregoing provisions of this Section shall constitute Seller's sole and exclusive liability and Buyer's sole and exclusive remedy for infringement of Intellectual Property Rights.

20. **Taxes.** Unless otherwise indicated, all prices and charges are exclusive of excise, sales, use, property, occupational or like taxes which may be imposed by any taxing authority upon the manufacture, sale or delivery of Products.

21. **Equal Opportunity Clause.** For the performance of government contracts and where dollar value of the Products exceed \$10,000, the equal employment opportunity clauses in Executive Order 11246, VEVRAA, and 41 C.F.R. §§ 60-1.4(a), 60-741.5(a), and 60-250.4, are hereby incorporated.



Parker Hannifin Corporation

Sporlan Division

206 Lange Drive • Washington, MO 63090 USA

phone 636 239 1111 • fax 636 239 9130

www.parker.com/zoomlock