

*JohnsonSuisse*  
Bathroom Solutions



LISTO SMART TOILET





LISTO SMART TOILET



Johnson Suisse is part of the Roca Group, the world's leading bathroom products manufacturer supported by a network of 76 factories in over 170 markets. A multinational corporation with design centres around the world to meet the standards and requirements of the Australian market, backed by local teams to provide support and services with a leading 25 years' VC warranty.









INNOVATIVE  
INTELLIGENT  
INTUITIVE  
INDISPENSABLE

## **DISCOVER THE POWER OF WATER**

A new generation of toilets in which technology and water take centre stage, bringing hygiene and comfort to a new dimension.

## **FUNCTIONALITY, DESIGN AND ACCESSIBLE TECHNOLOGY**

Experience a new level of bathroom that combines advanced functionality with user-friendly features to elevate your daily routine. Say goodbye to ordinary and embrace the extraordinary, upgrade your bathroom today and discover a world of comfort, style and inclusivity.



## **MORE INTUITIVE**

You won't believe how easy it is. With Johnson Suisse Listo you will enjoy a perfect experience from day one.



## **MORE HYGIENIC**

There is nothing so natural, so simple and yet so revolutionary as water to achieve outstanding intimate hygiene.



## **MORE COMFORT**

Easily customisable settings to adapt to the preferences of every user.









# OPEN THE DOOR TO TECHNOLOGY

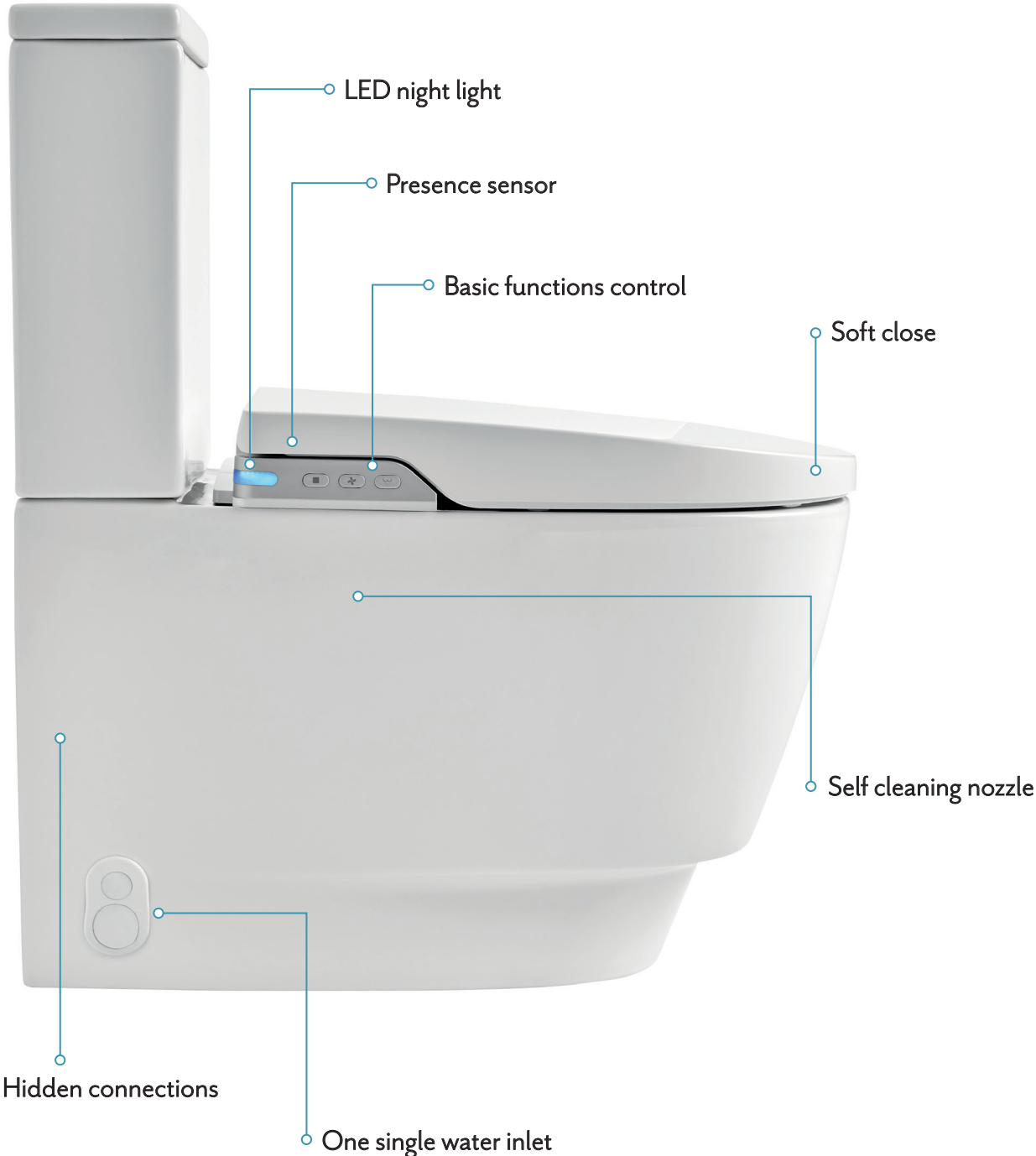



## Control panel

A simple side panel activates the main washing and drying functions of the toilet.



## Presence sensor

An infrared sensor prevents the toilet from activating if it doesn't detect any presence on the seat.



## Rimless

Johnson Suisse Listo is a rimless toilet. Water flows from the rear, homogeneously reaching the entire bowl.





## Night light

LED light located at the rear end of the seat guides users to the toilet, without having to turn on the bathroom lights.

4 functions:

Standard: it activates when the cover is lifted and turns off one minute after detecting any presence.

Night light: The light remains on for 8 hours at night.

Standard with night light: The light remains on for 8 hours and it works in Standard mode for the remaining 16 hours.

Off: The LED light is always off when this function is chosen.



## Design and comfort

Inspired by minimalism, Johnson Suisse Listo adapts to all kinds of interior designs, ensuring maximum comfort.



### **Soft-close seat**

The seat features soft-close hinges and therefore it closes silently, avoiding involuntary blows.



### **Removable seat**

In order to make cleaning easier, the seat and cover can be fully removed with one simple action.



### **Concealed connections**

To obtain a cleaner design, the water and power connections can be hidden behind the toilet. Its installation only requires a common water inlet.





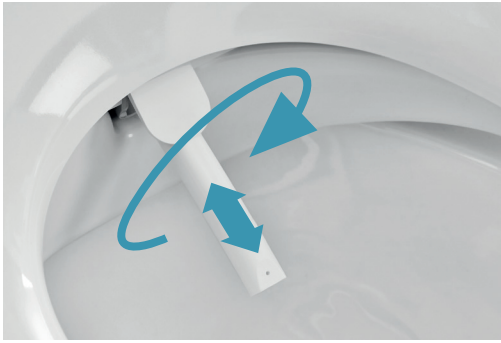

### **Detachable nozzle**

The nozzle can be easily detached, in order to clean it thoroughly.

---



### **Self-cleaning nozzle**

The retractable nozzle cleans itself before and after each use to ensure maximum hygiene.

---



### **Adjustable position**

The nozzle has five different positions so as to provide greater precision and comfort.



# FEATURES

An extraordinary toilet with an outstanding performance. Johnson Suisse Listo moves forward in innovation and development to offer the most comprehensive functionality.

Low battery warning

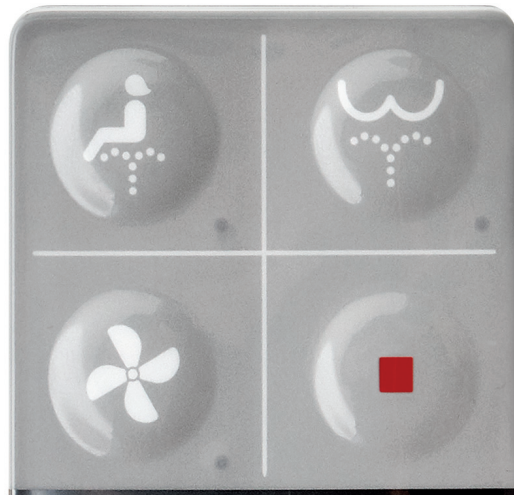

Main functions:  
washing and drying

Light signal to indicate the temperature, water pressure, or the position of the nozzle.



Regulation of:

- Water temperature
- Air temperature
- Water pressure
- Nozzle position

Easy operation, even with one hand

Remote control is supported magnetically by a remote holder

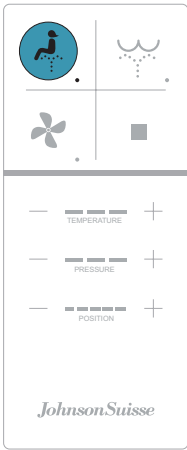

### Frontal wash

The nozzle is activated in the front position.

Adjustable settings:

- Water temperature
- Water pressure
- Nozzle position
- Oscillating movement of nozzle

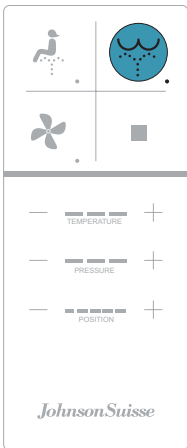

### Rear wash

The nozzle is activated in the rear position.

Adjustable settings:

- Water temperature
- Water pressure
- Nozzle position
- Oscillating movement of nozzle

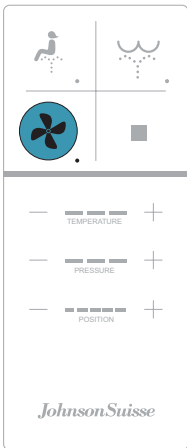

### Drying

The drying function is activated.

- Adjustable air temperature

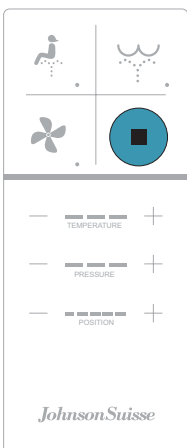

### Stop

It stops any active function.



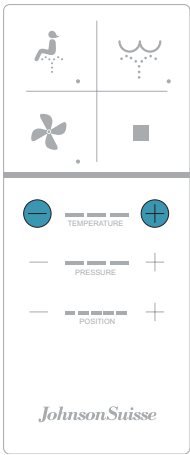

### Water temperature

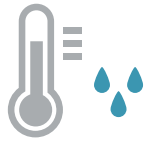

The water temperature has four adjustment levels:  
 Ambient: no LEDs light up  
 Low: one LED lights up  
 Medium: two LEDs light up  
 High: three LEDs light up

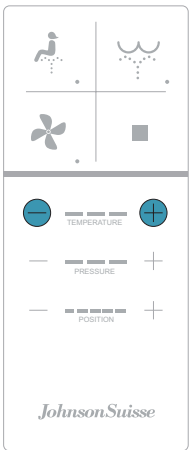

### Air temperature

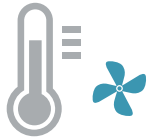

The air temperature has four adjustment levels:  
 Ambient: no LEDs light up  
 Low: one LED lights up  
 Medium: two LEDs light up  
 High: three LEDs light up

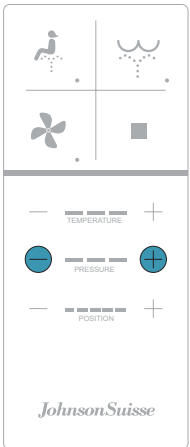

### Water pressure



The water pressure has three adjustment levels.

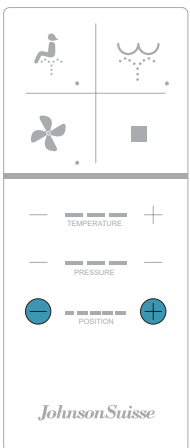

### Nozzle position



The nozzle has 5 different positions to meet the needs of every user. By default, it starts in the middle position, moving two positions to the front and two to the rear.

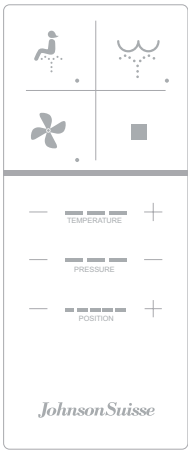

### Low battery

When the battery is low, all LED lights in the remote control blink at the same time.





# LISTO SMART TOILET SUITE



## LISTO SMART TOILET RIMLESS SUITE JSTL400

- Smart Shower Toilet - rimless vitreous china with integrated shower bidet and drying functions
- Automatic user detection and convenient nightlight
- Frontal and rear shower cleansing functions - adjustable nozzle positioning, temperature and pressure
- Comfort drying function - adjustable temperature
- Automatic nozzle cleaning function
- Soft-close, quick-release toilet seat
- Remote and seat-mounted control
- 25 years product replacement (VC only), 1 years toilet seat and electrical
- WELS 4 Star, 4.6/3.1L (3.3L average flush) L07698

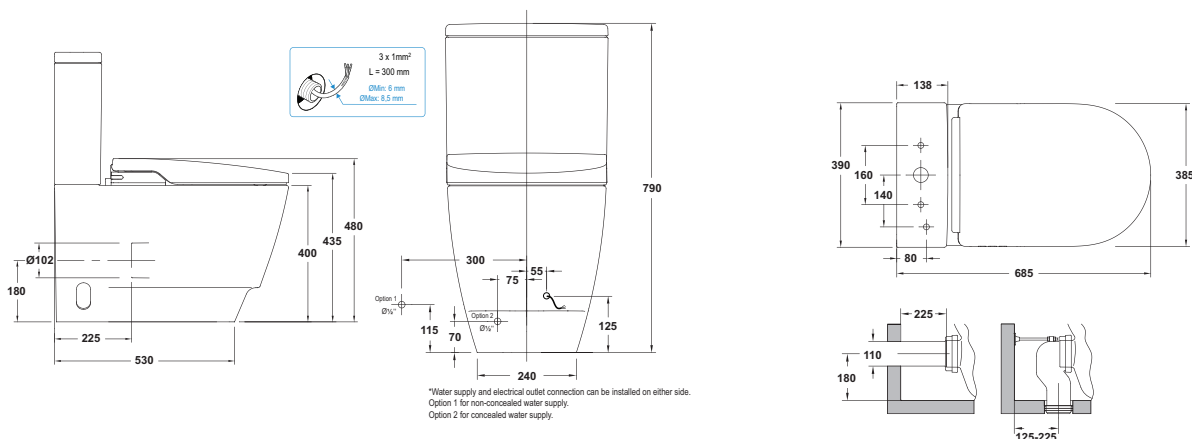
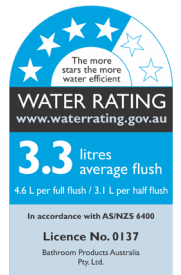





**JohnsonSuisse**  
*Bathroom Solutions*

2/97 Banksia Street, Botany NSW 2019 | T 1300 717 717 | [www.johnsonsuisse.com.au](http://www.johnsonsuisse.com.au)

BATHROOM PRODUCTS AUSTRALIA PTY LTD ABN 87 079 297 617

VIC Showroom: 31 Koornang Road, Scoresby VIC 3179 Australia | T 1300 717 717

SYDNEY Showroom : 2/97 Banksia St. Botany Sydney NSW 2019 Australia | T 1300 717 717

Material and design specifications subject to change without notice.

Product colour reproduction is as near to actual product colour as production methods allow.

This brochure relates to Australian products only and some product, design or specifications may differ in other countries.