

Pleated Bias Skirts: Cutting & Calculating

Version 2.2a

A technical guide for sample makers and production managers.

Yes...we have an iPhone App!
myProductionPal

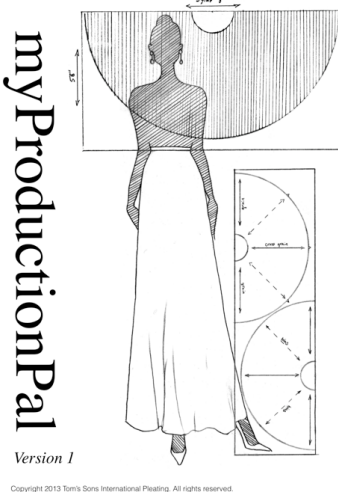

The purpose of this technical manual is:

- To ensure the proper cutting of pleated bias skirts or dresses.
- To assist fashion designers in calculating fabric yardage.
- To assist in hem length calculations in the case that wire or trim is used in the finished hem.

How to use this technical manual:

- Determine the width of your fabric and length of your skirt.
- Determine if your garment will have a center back seam or a side seam. (Note: Center back layout will save on yardage.)
- Look up the corresponding lengths to determine your needs.

Is this information only for pleated skirts?

No, if you make adjustments to the waist calculations you can use these markers, and yardages for non pleated bias circle skirts. The standard waist measurement in the following markers are 10 inch radii. That measurement yields a circumference of 60 inches at the waist. After pleating the waist measurement is reduced up to 50% depending on the fabric and the amount of shirring in the sewing of the garment. If you reduce the radius of waist you can use these calculating for non pleated garments. For every inch you reduce in the radius at the waist, the measurement will reduce by 6 inches for a total circle, and 3 inch for a half circle. For example, if you cut the waist 3 inches smaller at the radius (7in.), subtract 18 inches from 60 inches which equals 48 inches for a full circle. 24 inches for a half circle. This measurement is dependent on the waist of your customer and the amount or gathering you desire in your design. Keep in mind that this area at the waist is bias so it is malleable (especially with chiffons). Call for more information.

Additional information:

- Yardages are approximate and have an allowance of 4 inches per marker.
- The skirt length indicated in the drawings do not compensate for loss of length due to seam allowance at hem or waist. For example, if you cut a 32in skirt and use 1/2 seam allowance at the waist and hem, the finished length will be 31in.

About Us:

We are pleating contractors with over 80 years of industry experience. Our facility is capable of all types of pleating from table/hand pleating to machine pleating. We take pride in our technical capabilities, which is evident in our unique and couture pleating. Please email or call us if you have any questions regarding the use of this document. Your feedback is encouraged.

How to read the drawings:

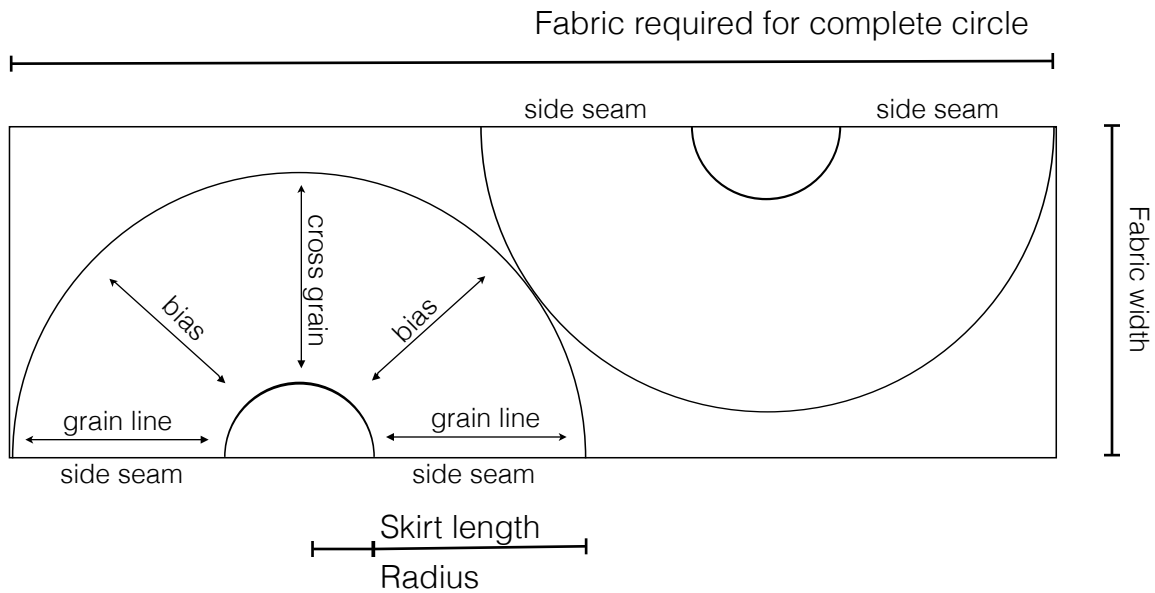
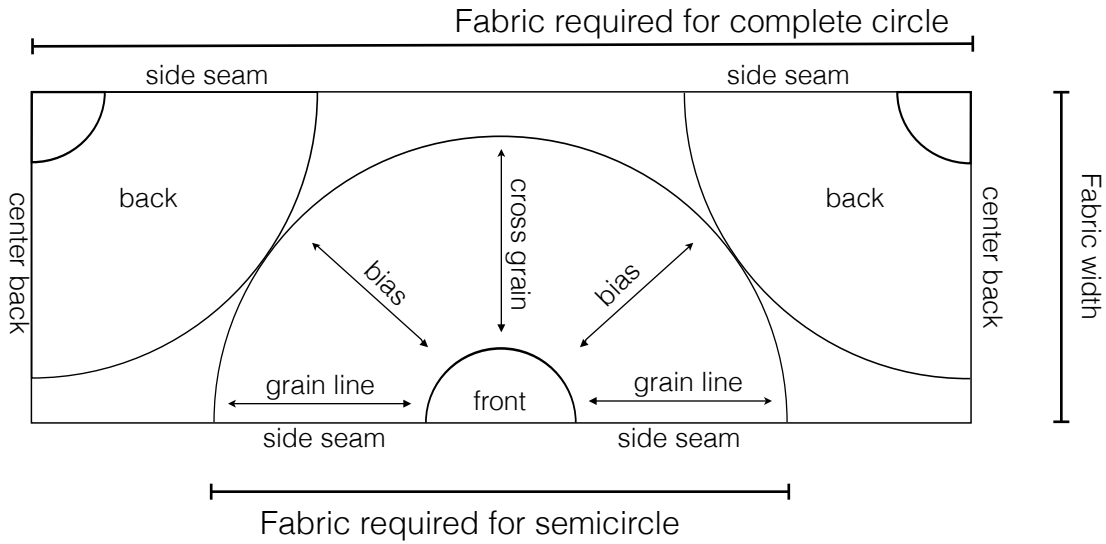

44 inch Width Fabric - Skirt Length 28 inches

Marker layout with center back seam:

Total fabric used = 3 yards 22 inches (3.3 meters)

Fabric used for half a circle = 2 yards 4 inches (1.94 meters)

Distance around the hem = 6 yards 23 inches (6.1 meters)

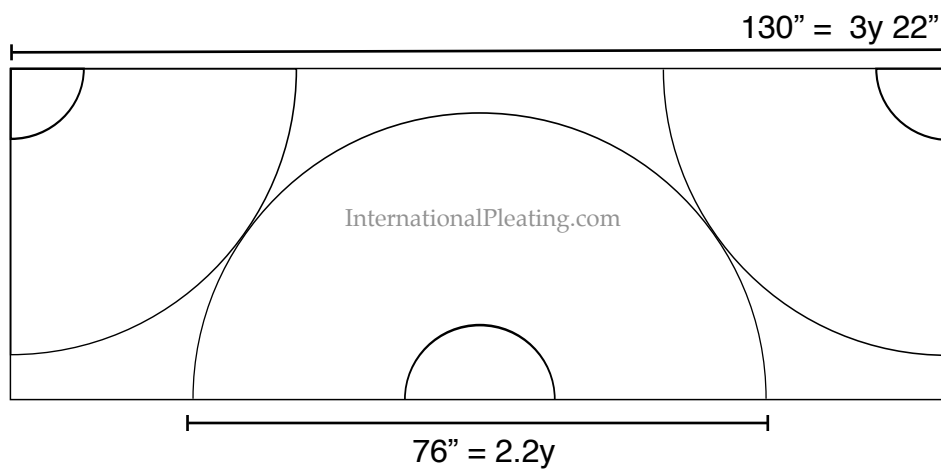

Marker layout with side seam:

Total fabric used = 4 yards (3.7 meters)

Fabric used for half a circle = 2 yards 4 inches (1.94 meters)

Distance around the hem = 6 yards 23 inches (6.1 meters)

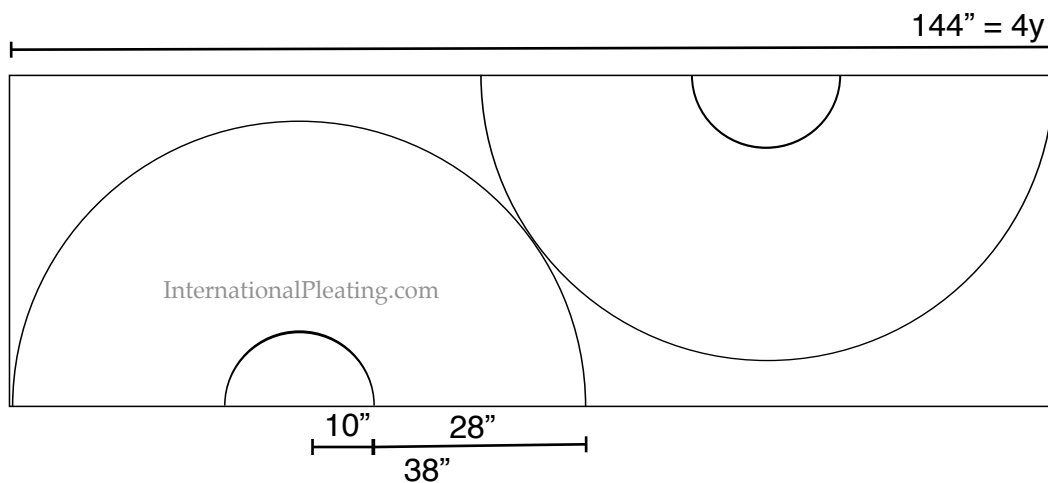

44 inch Width Fabric - Skirt Length 30 inches

Marker layout with center back seam:

Total fabric used = 3 yards 30 inches (3.6 meters)

Fabric used for half a circle = 2 yards 8 inches (2.1 meters)

Distance around the hem = 7 yards (6.4 meters)

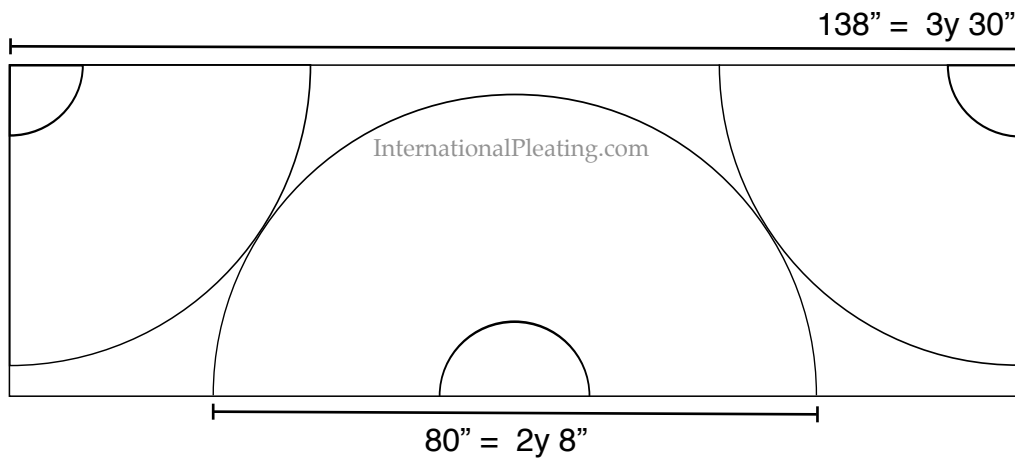

Marker layout with side seam:

Total fabric used = 4 yards 9 inches (3.9 meters)

Fabric used for half a circle = 2 yards 8 inches (2.1 meters)

Distance around the hem = 7 yards (6.4 meters)

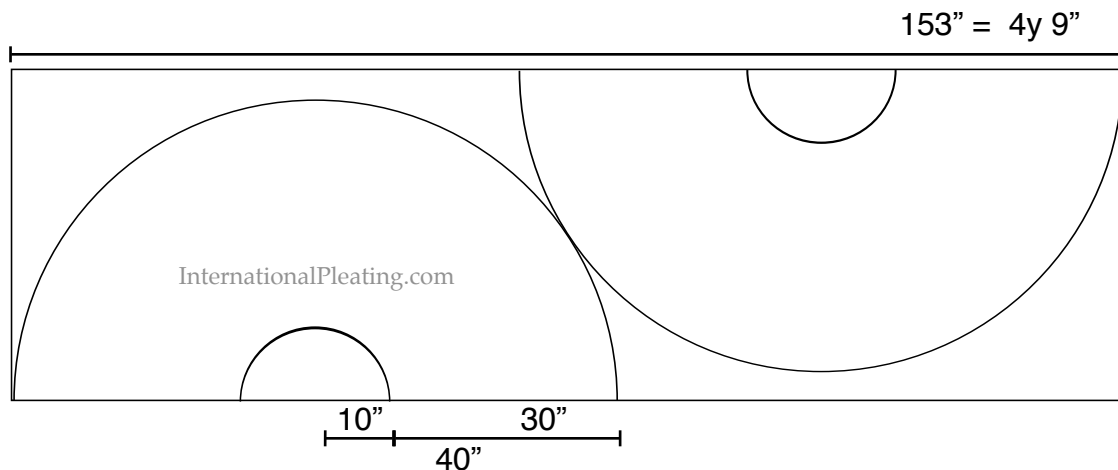

44 inch Width Fabric - Skirt Length 32 inches

Marker layout with center back seam:

Total fabric used = 4 yards 4 inches (3.8 meters)

Fabric used for half a circle = 2 yards 12 inches (2.2 meters)

Distance around the hem = 7 yards 12 inches (6.8 meters)

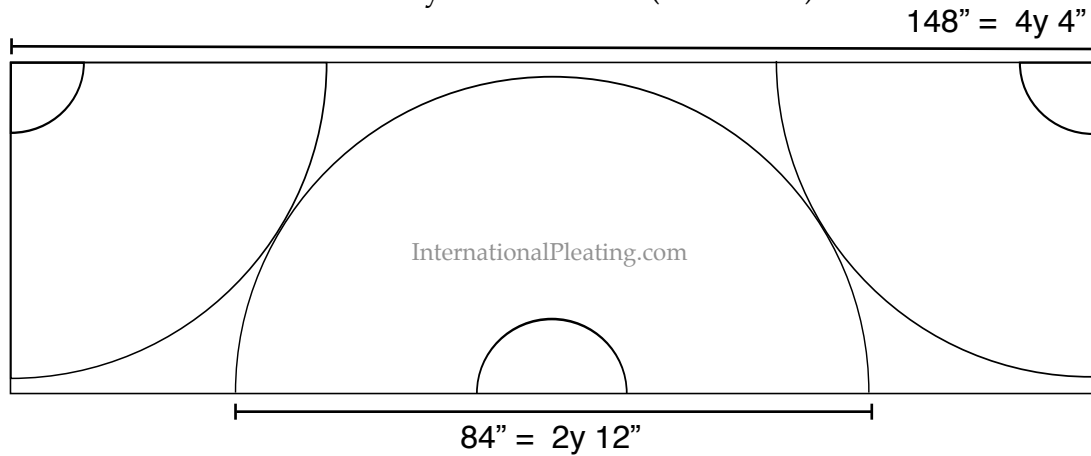

Marker layout with side seam:

Total fabric used = 4 yards 16 inches (4.1 meters)

Fabric used for half a circle = 2 yards 12 inches (2.2 meters)

Distance around the hem = 7 yards 12 inches (6.8 meters)

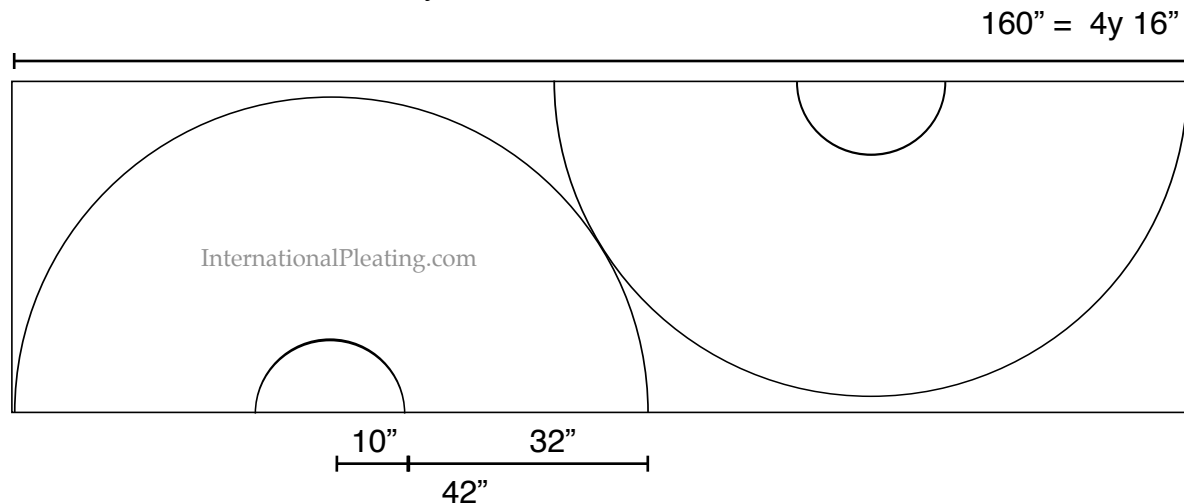

44 inch Width Fabric - Skirt Length 34 inches

Marker layout with center back seam:

Total fabric used = 4 yards 14 inches (4.1 meters)

Fabric used for half a circle = 2 yards 16 inches (2.4 meters)

Distance around the hem = 7 yards 25 inches (7.1 meters)

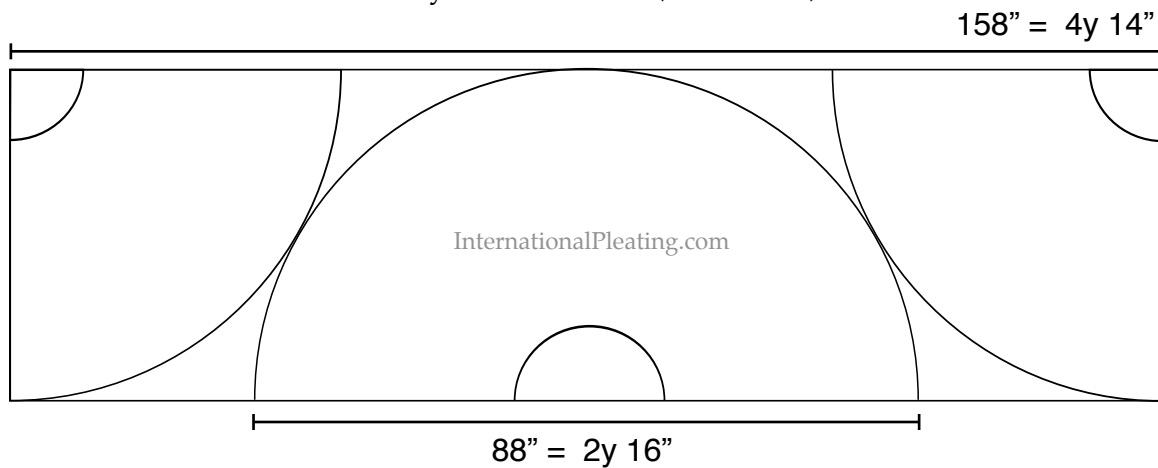

Marker layout with side seam:

Total fabric used = 4 yards 26 inches (4.4 meters)

Fabric used for half a circle = 2 yards 16 inches (2.4 meters)

Distance around the hem = 7 yards 25 inches (7.1 meters)

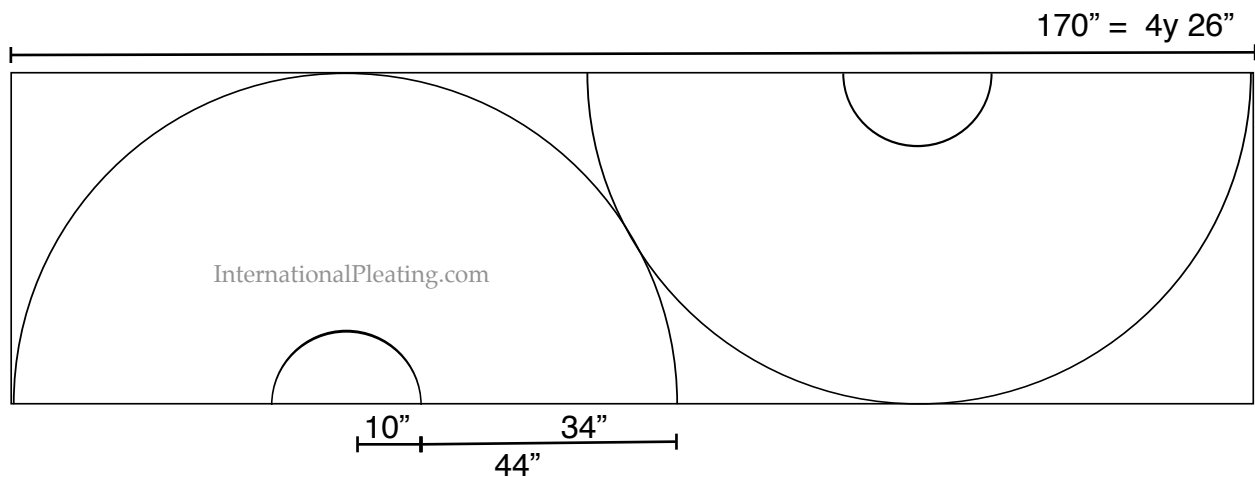

54 inch Width Fabric - Skirt Length 32 inches

Marker layout with center back seam:

Total fabric used = 3 yards 28 inches (3.5 meters)

Fabric used for half a circle = 2 yards 12 inches (2.2 meters)

Distance around the hem = 7 yards 12 inches (6.1 meters)
136" = 3y 28"

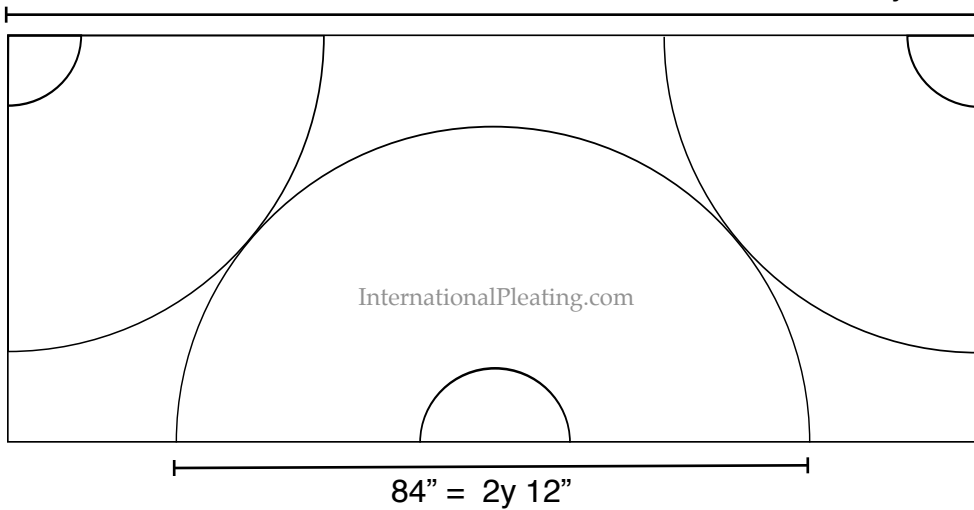

Marker layout with side seam:

Total fabric used = 4 yards 11 inches (4 meters)

Fabric used for half a circle = 2 yards 12 inches (2.2 meters)

Distance around the hem = 7 yards 12 inches (6.1 meters)
155" = 4y 11"

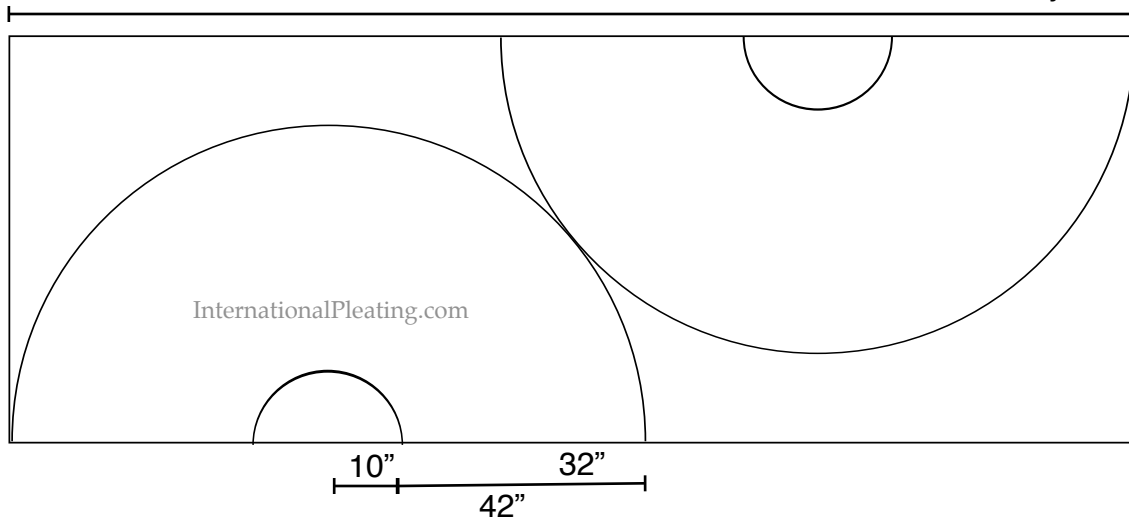

54 inch Width Fabric - Skirt Length 36 inches

Marker layout with center back seam:

Total fabric used = 4 yards 10 inches (4 meters)

Fabric used for half a circle = 2 yards 20 inches (2.4 meters)

Distance around the hem = 8 yards 1 inches (7.4 meters)

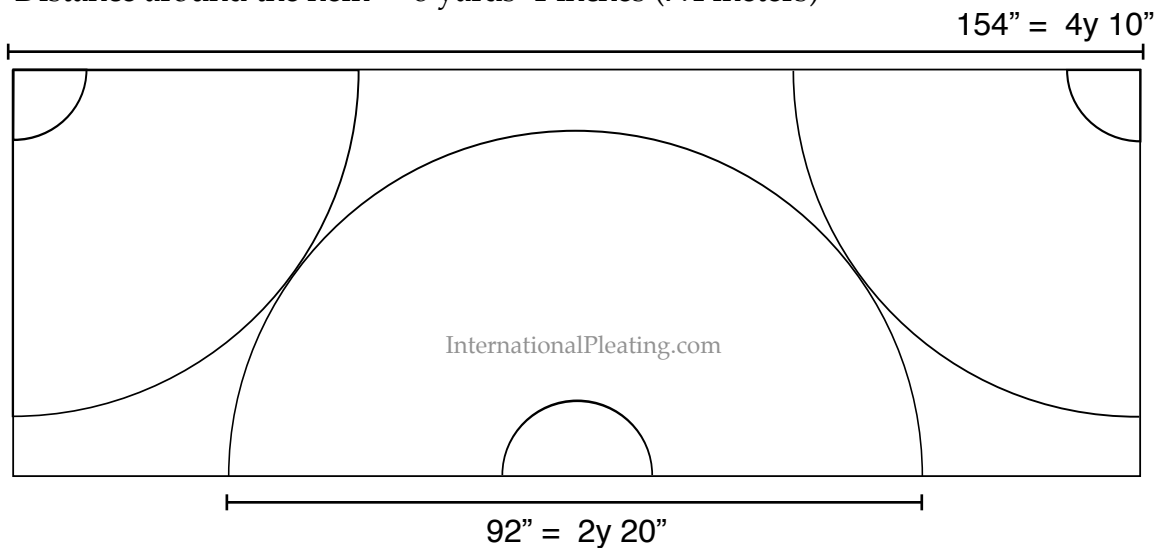

Marker layout with side seam:

Total fabric used = 4 yards 30 inches (4.5 meters)

Fabric used for half a circle = 2 yards 20 inches (2.4 meters)

Distance around the hem = 8 yards 1 inches (7.4 meters)

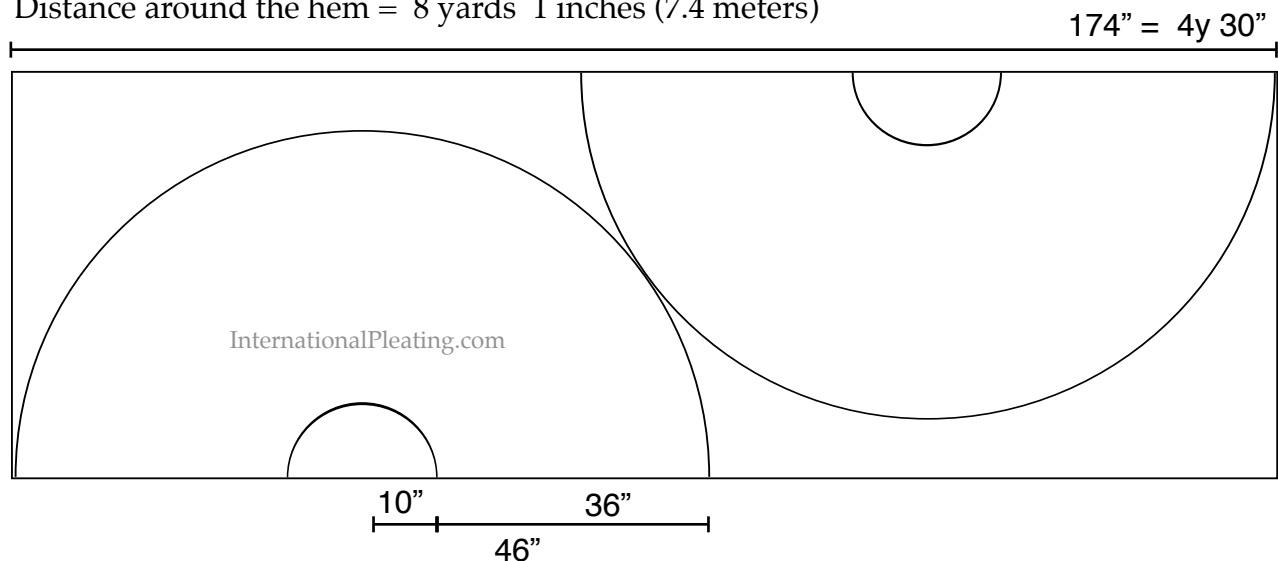

54 inch Width Fabric - Skirt Length 40 inches

Marker layout with center back seam:

Total fabric used = 4 yards 29 inches (4.4 meters)

Fabric used for half a circle = 2 yards 28 inches (2.6 meters)

Distance around the hem = 8 yards 26 inches (8 meters)

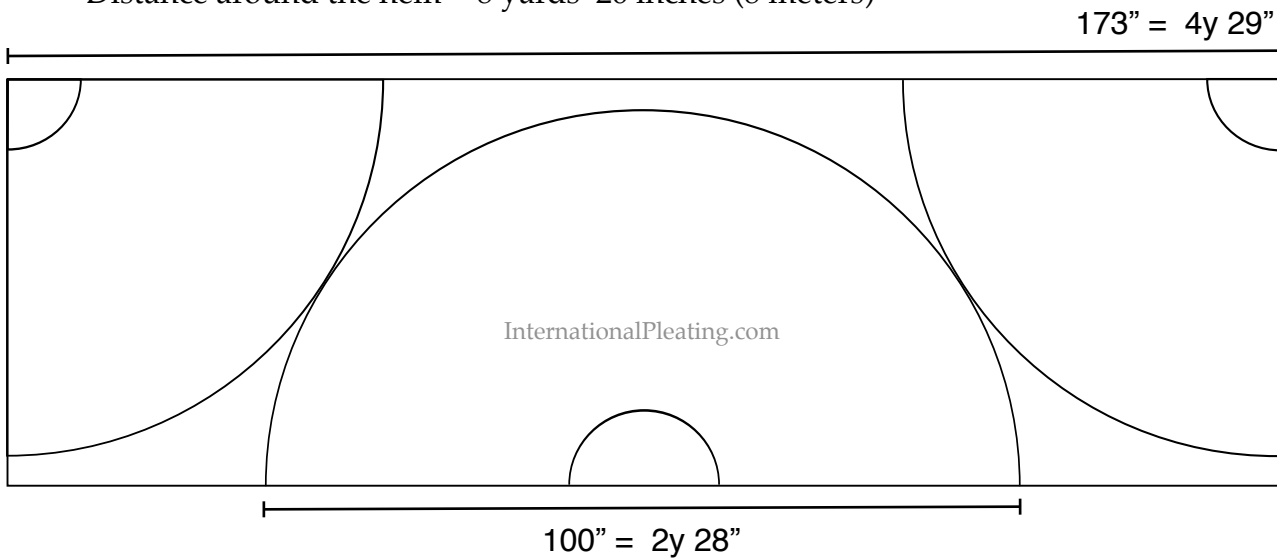

Marker layout with side seam:

Total fabric used = 5 yards 10 inches (4.9 meters)

Fabric used for half a circle = 2 yards 28 inches (2.6 meters)

Distance around the hem = 8 yards 26 inches (8 meters)

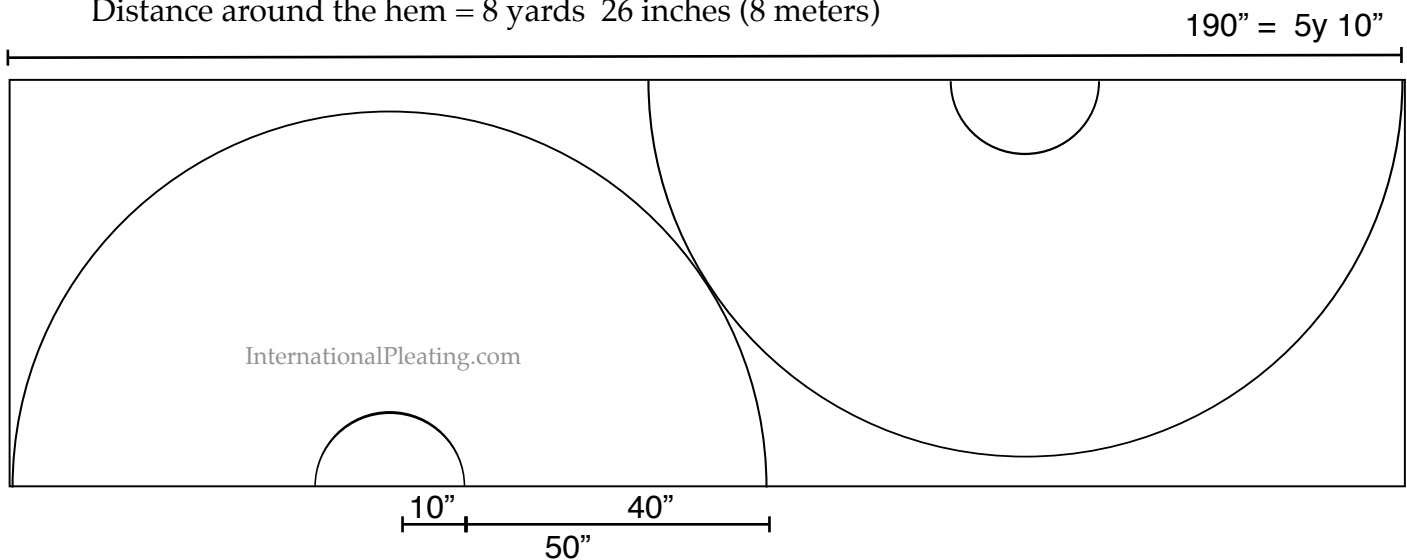

54 inch Width Fabric - Skirt Length 44 inches

Marker layout with center back seam:

Total fabric used = 5 yards 12 inches (4.9 meters)

Fabric used for half a circle = 3 yards (2.8 meters)

Distance around the hem = 9 yards 16 inches (8.7 meters)

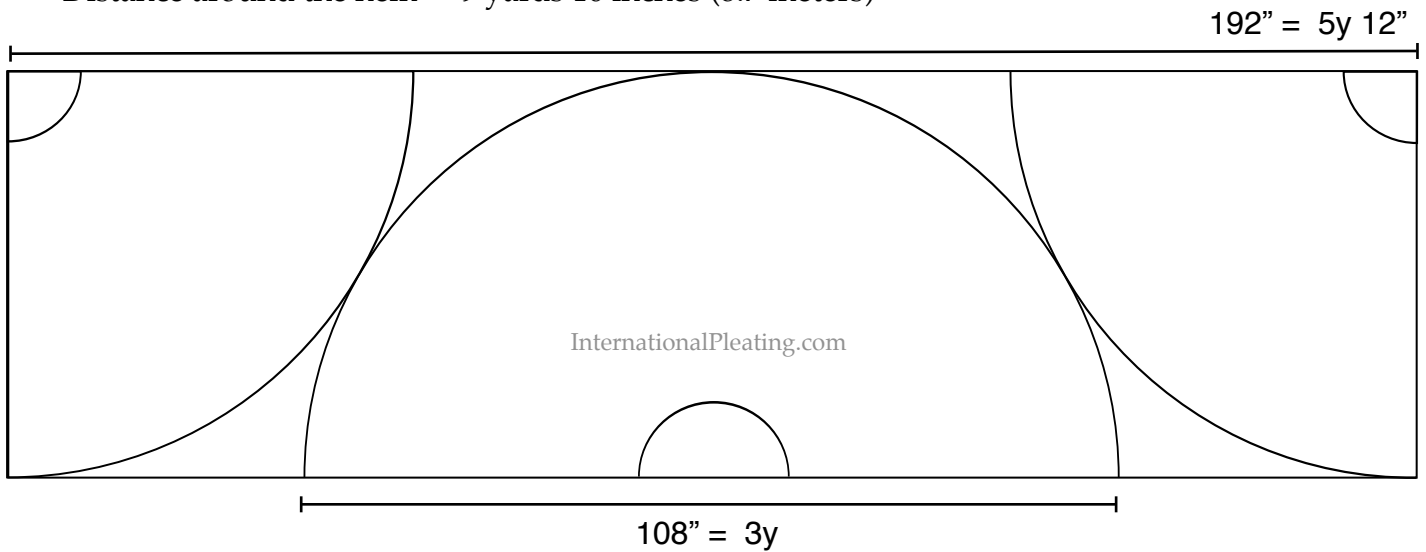

Marker layout with side seam:

Total fabric used = 5 yards 28 inches (5.3 meters)

Fabric used for half a circle = 3 yards (2.8 meters)

Distance around the hem = 9 yards 16 inches (8.7 meters)

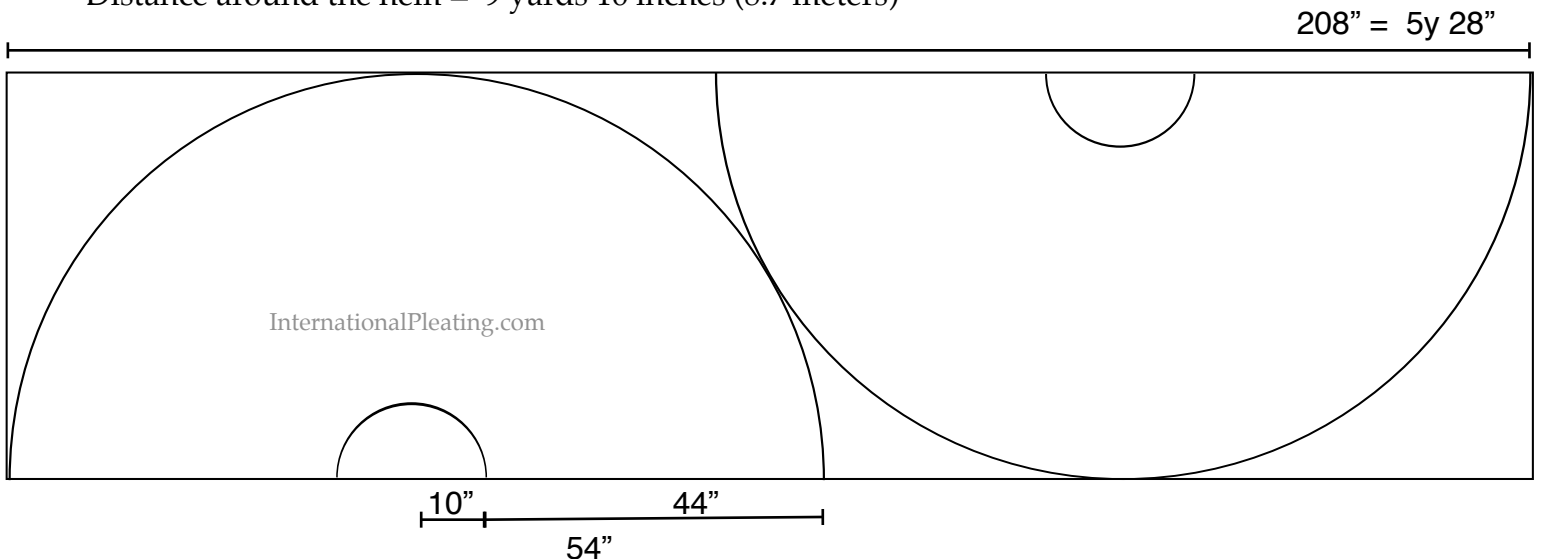

58 inch Width Fabric - Skirt Length 32 inches

Marker layout with center back seam:

Total fabric used = 3 yards 17 inches (3.2 meters)

Fabric used for half a circle = 2 yards 12 inches (2.2 meters)

Distance around the hem = 7 yards 12 inches (6.8 meters)

$$125'' = 3y 17''$$

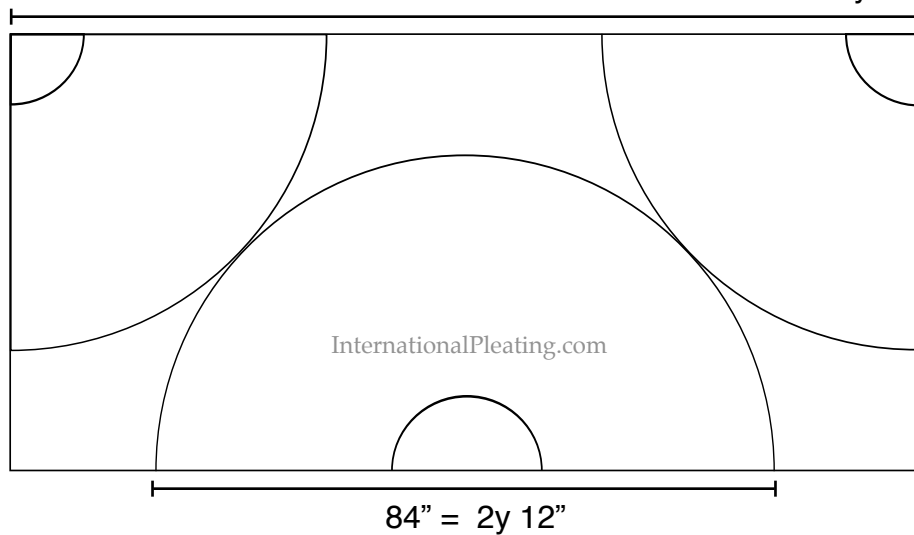

Marker layout with side seam:

Total fabric used = 4 yards 6 inches (3.9 meters)

Fabric used for half a circle = 2 yards 12 inches (2.2 meters)

Distance around the hem = 7 yards 12 inches (6.8 meters)

$$150'' = 4y 6''$$

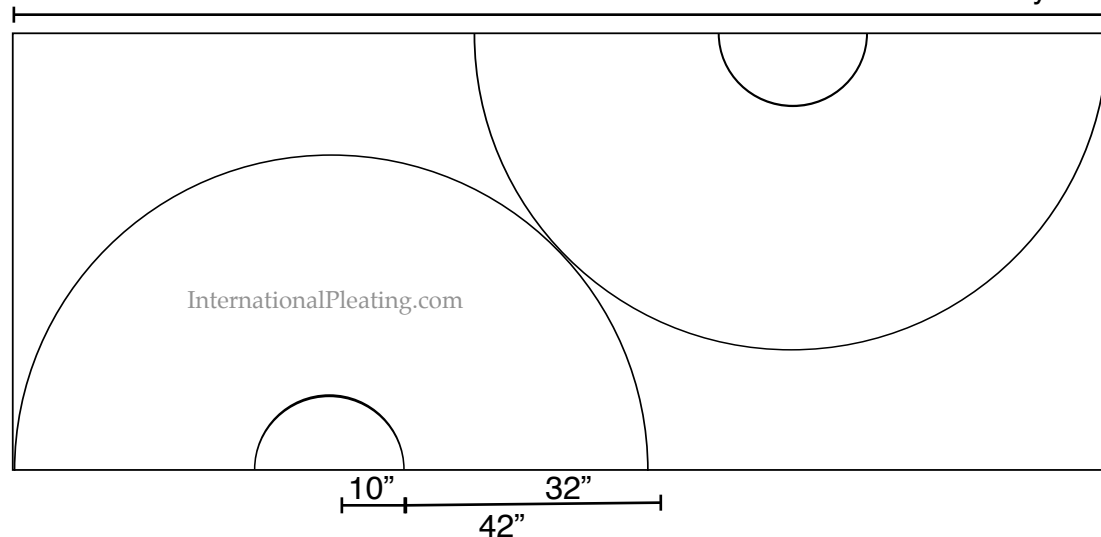

58 inch Width Fabric - Skirt Length 36 inches

Marker layout with center back seam:

Total fabric used = 4 yards 4 inches (3.8 meters)

Fabric used for half a circle = 2 yards 20 inches (2.4 meters)

Distance around the hem = 8 yards 1 inches (7.4 meters)

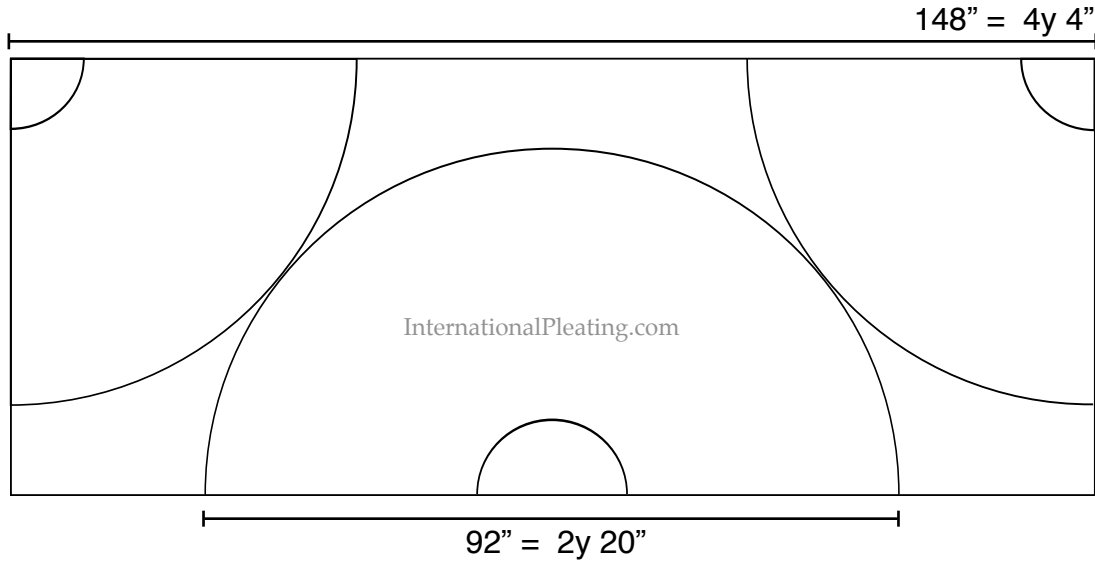

Marker layout with side seam:

Total fabric used = 4 yards 28 inches (4.4 meters)

Fabric used for half a circle = 2 yards 20 inches (2.4 meters)

Distance around the hem = 8 yards 1 inches (7.4 meters)

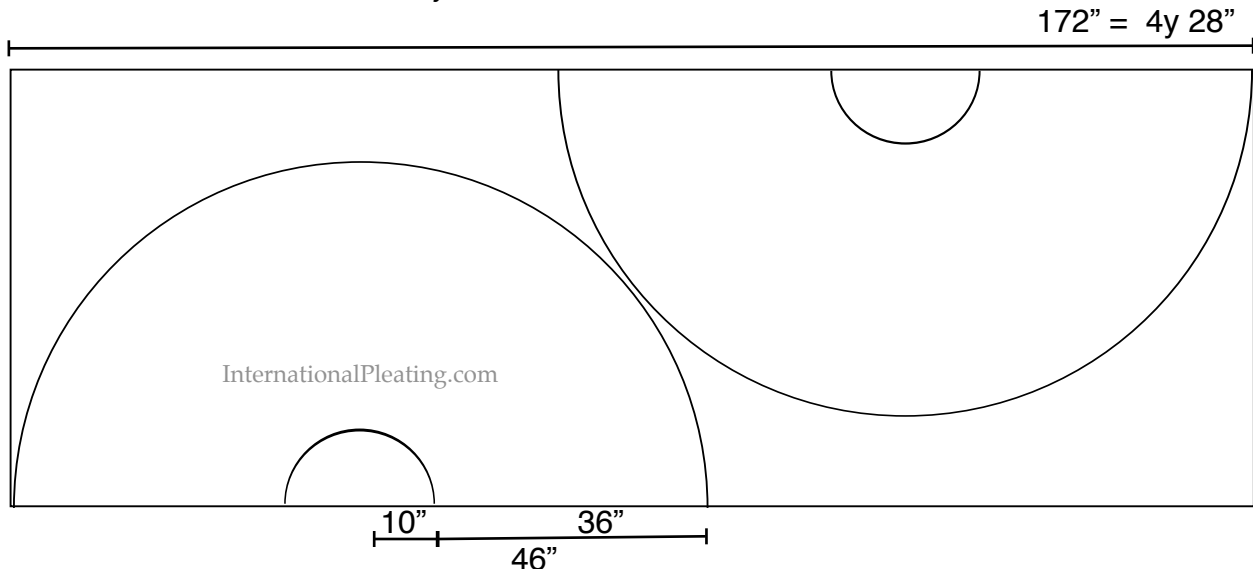

58 inch Width Fabric - Skirt Length 40 inches

Marker layout with center back seam:

Total fabric used = 4 yards 24 inches (4.3 meters)

Fabric used for half a circle = 2 yards 28 inches (2.6 meters)

Distance around the hem = 8 yards 26 inches (8 meters)

168" = 4y 24"

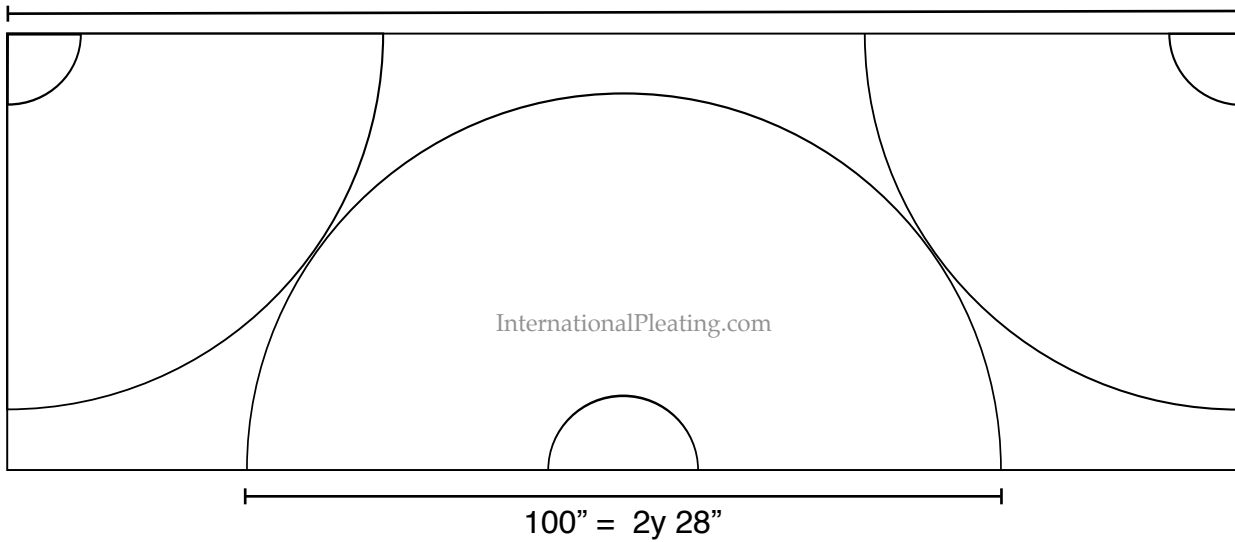

Marker layout with side seam:

Total fabric used = 5 yards 10 inches (4.9 meters)

Fabric used for half a circle = 2 yards 28 inches (2.6 meters)

Distance around the hem = 8 yards 26 inches (8 meters)

190" = 5y 10"

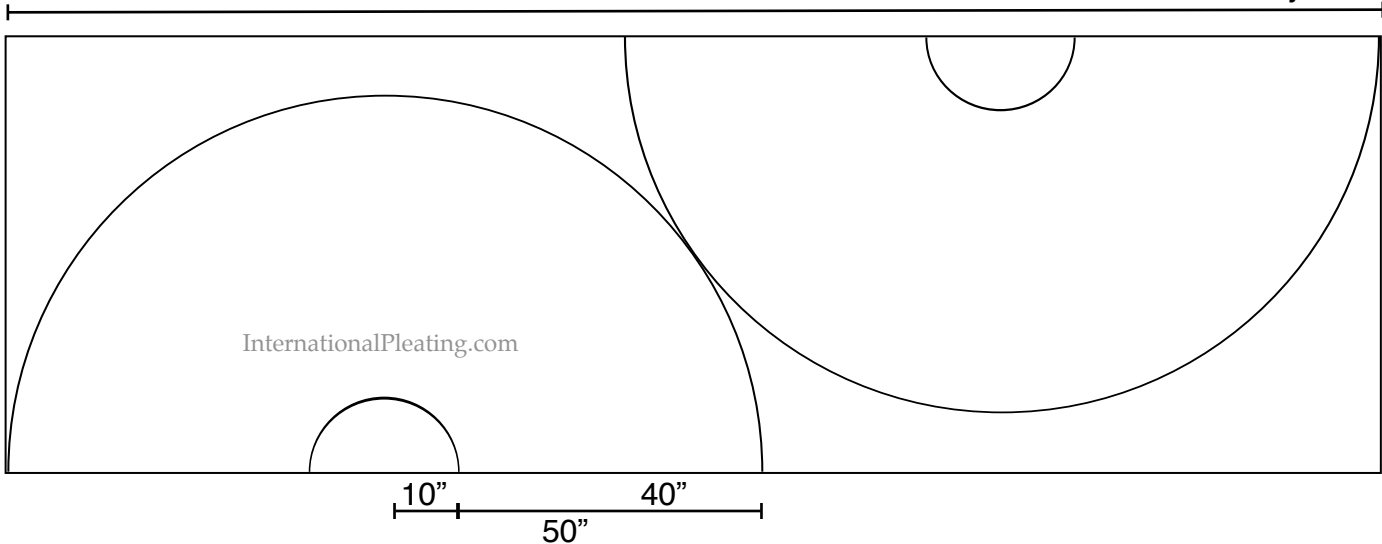

58 inch Width Fabric - Skirt Length 45 inches

Marker layout with center back seam:

Total fabric used = 5 yards 12 inches (4.9 meters)

Fabric used for half a circle = 3 yards 2 inches (2.8 meters)

Distance around the hem = 9 yards 22 inches (8.8 meters)

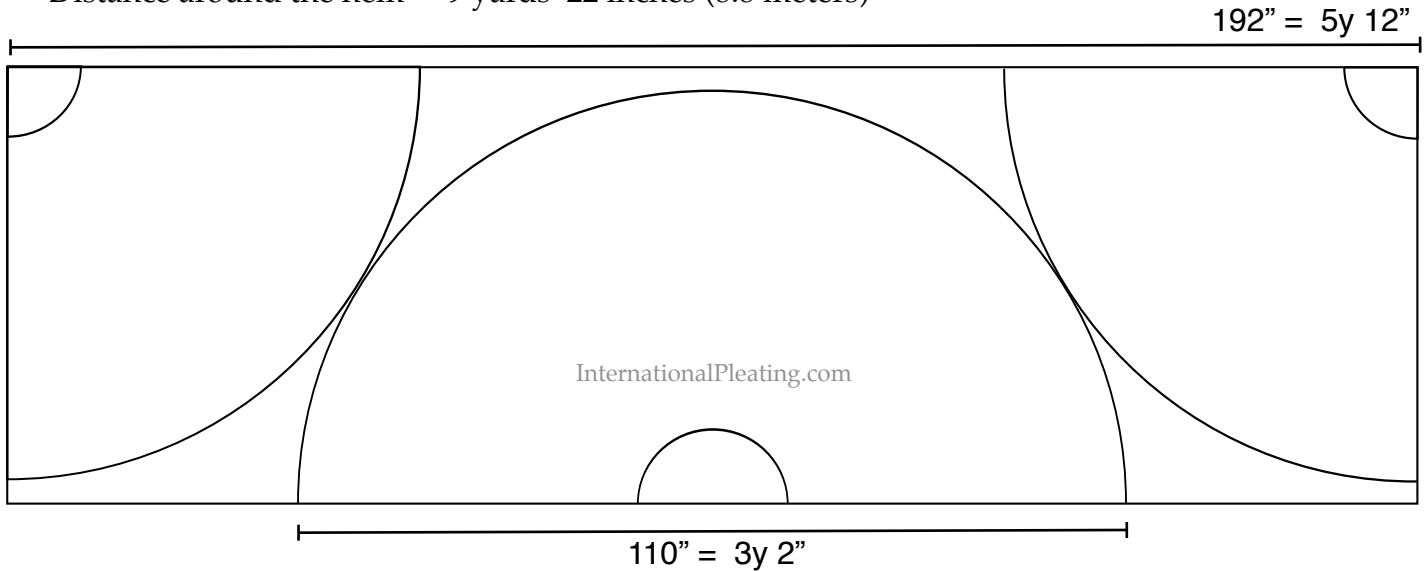

Marker layout with side seam:

Total fabric used = 5 yards 30 inches (5.4 meters)

Fabric used for half a circle = 3 yards 2 inches (2.8 meters)

Distance around the hem = 9 yards 22 inches (8.8 meters)

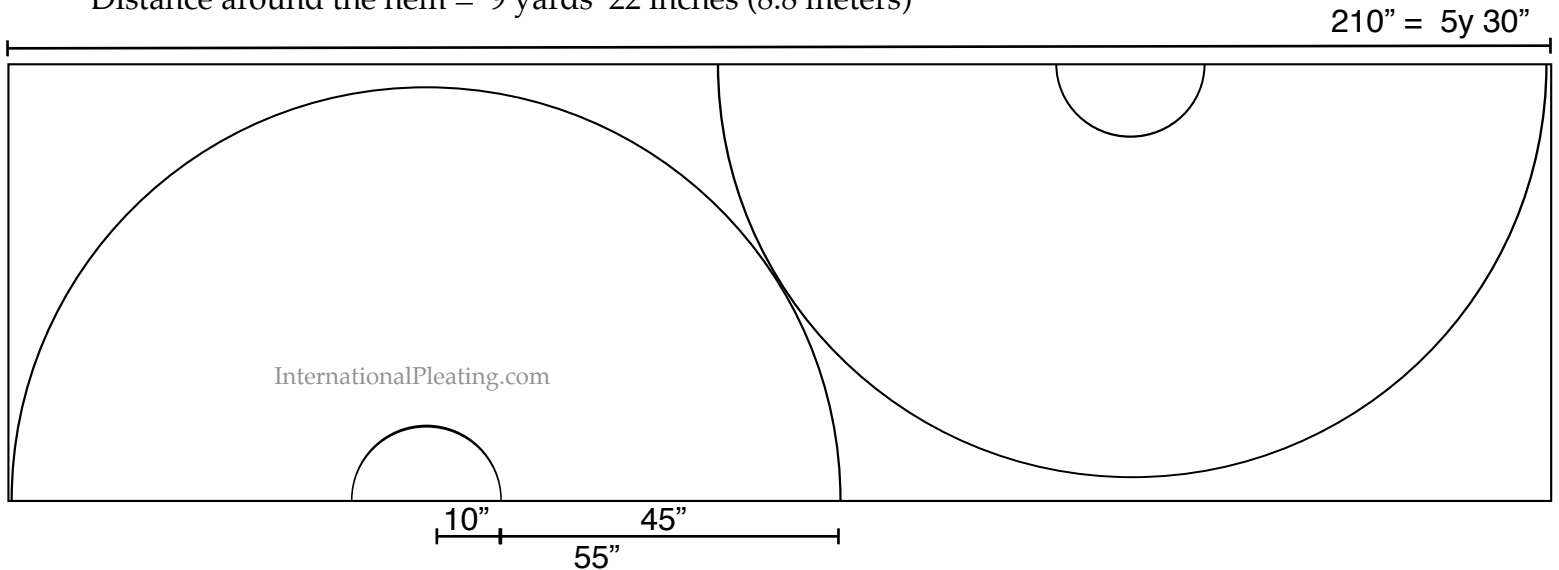

58 inch Width Fabric - Skirt Length 48 inches

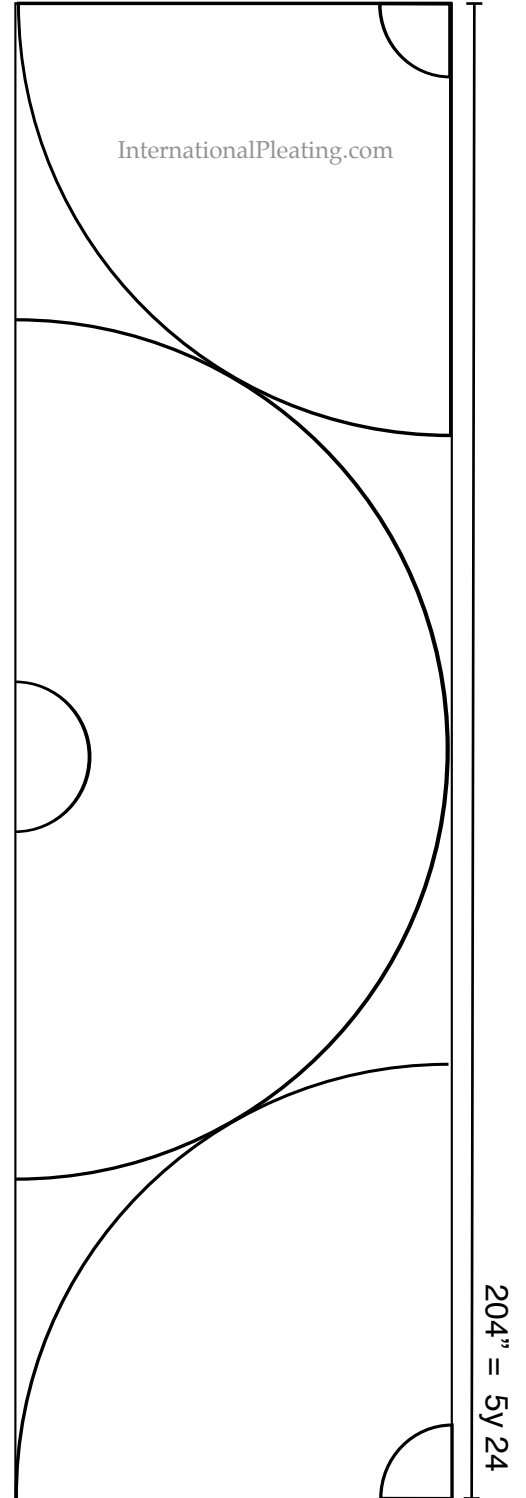

Marker layout with center back seam: 116" = 3y 8"

Total fabric used = 5 yards 24 inches (5.3 meters)

Fabric used for half a circle = 3 yards 8 inches (3 meters)

Distance around the hem = 10 yards 5 inches (9.3 meters)

Marker layout with side seam:

Total fabric used = 6 yards 4 inches (5.6 meters)

Fabric used for half a circle = 3 yards 8 inches (3 meters)

Distance around the hem = 10 yards 5 inches (9.3 meters)

220" = 6y 4"

