

# KIIN

## Lámpara colgante Grande & Extra Grande Instructivo

### Información eléctrica / Electrical information:

Recomendamos el uso de foco LED /  
We recommend the use of LED bulb

Voltaje / Voltage: 120 V  
Frecuencia / Frequency 50-60 Hz

### Componentes / Components:

- 1 Pantalla con estructura metálica tejida de yute natural /  
Lampshade with metal structure woven from natural jute
- 2 Canope de aluminio color negro (medidas 12.7cm diámetro x 1.7cm alto) /  
Black aluminum canopy (measures 5inch diameter x 0.66 inch high).
- 3 Cable textil, 2x18, 1.50cm largo /  
Textile cable, 2x18 gauge, 59.05inch long
- 4 Socket de plástico reforzado, E26/27, Certificado UL /  
Reinforced plastic socket, E26/27, UL/Certified
- 5 Tuerca (x3) Nut (x3)
- 6 Pasacable para niple (x1) / Nipple cable gland (x1)
- 7 Pasacable estándar (x1) / Standard cable gland (x1)
- 8 Solera (x1) / Solera (x1)
- 9 Tornillo (x2) / Screw (x2)
- 10 Rondanas (x2) / Rounder (x2)
11. Triangulo para cadena unicamente en tamaño extra grande (x1) /  
Triangle for chain only in extra large size (x1)
12. Cadena de refuerzo unicamente en tamaño extra grande (x1) /  
Reinforcement chain only in extra large size (x1)

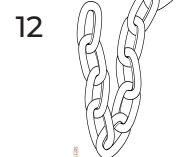
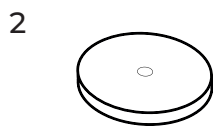
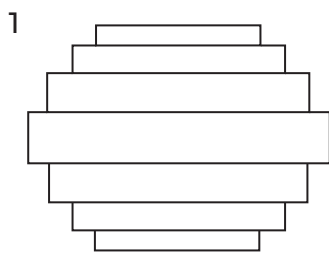

Proceso de instalación /  
Installation process

1. Desempacar la lámpara /  
Unpack the lamp
2. Desarmar el canope /  
Disassemble the canopy

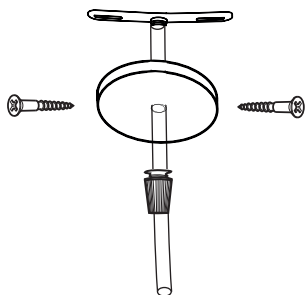

3. Sacar los nipples de plástico /  
Remove the plastic nipples

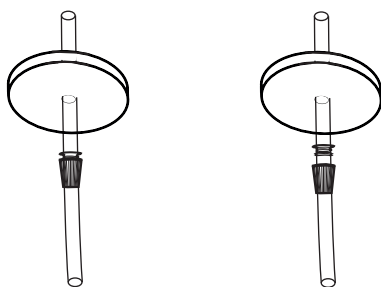

4. Pasar el cable por el tubo de la lámpara /  
Pass the cable through the lamp tube
5. Enroscar el socket al niple enroscado central /  
Twine the socket to the central threaded nipple

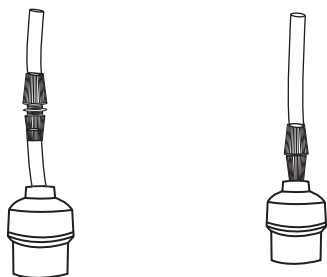

6. Armar la lámpara /  
Assemble the lamp
7. Quitar tapa de caja de luz en techo /  
Remove ceiling light box cover
8. Atornillar solera a los orificios de la caja /  
Screw the sill to the holes in the box

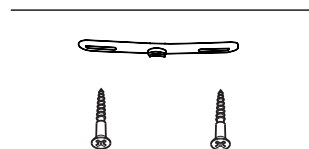

9. Ajustar altura /  
Adjust height
10. Abrir eslabón de cadena con pinzas e insertar la cadena en el triángulo, (paso unicamente para tamaño extra grande).  
Open chain link with pliers and insert the string into the triangle, ((only for extra large size)
11. Tapar con el canope la caja del techo y colocar los tornillos para fijar el canope /  
Cover the ceiling box with the canopy and place the screws to fix the canopy.

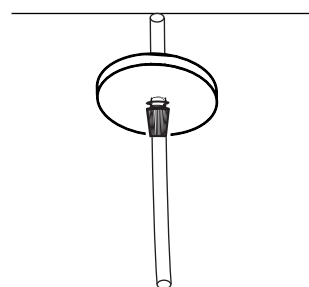

Despiece de lámpara /  
Lamp breakdown:

Salida eléctrica /  
Electrical instalation

Solera /  
Solera

Canope /  
Canopy

Porta foco /  
Socket

Pantalla /  
Lampshade

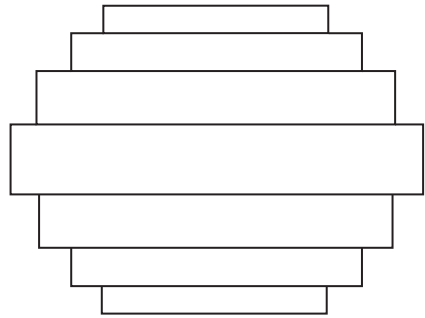
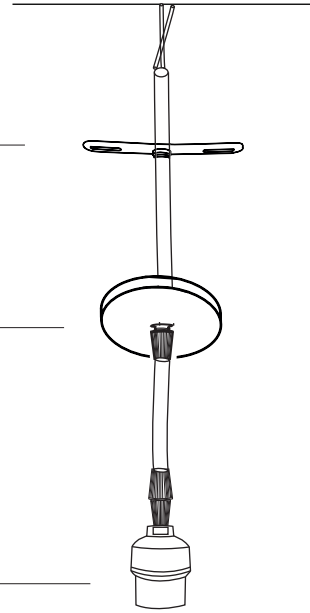

Herramientas /  
Tools:

Destornillador /  
Screwdriver



Llave para tuerca 1/2 /  
Nut wrench 1/2



Pinzas pelacables /  
Wire stripping pliers



Guantes de seguridad /  
Safety gloves



Importante /  
Important:

Se recomienda que la instalación sea realizada por un profesional.

Asegúrate de cortar corriente eléctrica del área a trabajar y de contar con todo el material de trabajo en perfecto estado así como del equipo seguridad adecuado.

Coloca los bombillos y retira el polvo con un paño de microfibra seco. No recomendamos usar paños húmedos. Conecta la corriente y enciende la lámpara desde la toma de energía.

It is recommended that the installation be carried out by a professional.

Make sure you turn off power to the area to be worked on and have all work materials in perfect condition as well as the equipment adequate security.

Place the bulbs and remove the dust with a dry microfiber cloth. No We recommend using damp cloths. Connect the power and turn on the lamp from the power outlet.

