Tipo
Type

Colgante
Pendant

Técnica
Technique

Tejida y soldada a mano
Hand woven and welded

Materiales
Materials

Yute natural 2 cabos
2-ply natural jute

Socket
Socket

Plástico reforzado E26/27 Certificado UL
Reinforced plastic E26/27 UL certificate

Canope
Canopy

Aluminio 12.7cm Ø x 1.7cm alto
Aluminum 50inch Ø x 0.66 inch height

Cable
Cord

1.5m largo, Calibre 2x18
59.05inch lenght / 2x18 gauge

Medidas
Measures

33cm Ø x 47cm largo
12.99inch Ø x 18.50inch lenght

Metros cúbicos
Cubic meters

0.0512 m³
2.0147 inch

Estructura metálica
Metallic structure

Calibre 3/8 (9mm) Acabado: pintada al horno con pintura electrostática
3/8 gauge (9mm)
Finish: baked painted with electrostatic painting

Peso
Weight

2 kg
4.40 lb

Foco
Lightbulb

Recomendamos el uso de foco LED
We recommend the use of an LED bulb

Soporte p/socket
Socket support

Pasacable de plástico para niple
Cable gland for nipple

Soporte p/canope
Canopy support

Pasacable de plástico
Plastic cable gland

Uso
IP Rating

Interior / Semi exterior
*Se recomienda el uso de exterior siempre y cuando sea un espacio techado
Indoor / Semi outdoor
*Outdoor use is always recommended and when it is a covered space

País de origen
Country of origin

México
México

NOTA:

JA esta hecha a mano con materiales naturales, por lo que pueden presentar variaciones en tamaño, color, forma y textura.

NOTE:

JA is handmade with natural materials, so they may present variations in size, color, shape and texture.

VARIANTES DEL MODELO

MODEL VARIANTS



CANOPE
Canopy



Blanco
White



Negro
Black



Negro
Black

CABLE
Cord



Blanco
White



Negro
Black



Negro
Black

ESTRUCTURA METÁLICA
Metallic structure

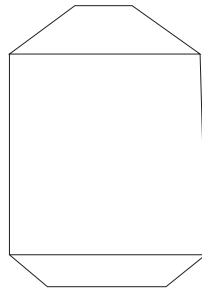

Blanco
White

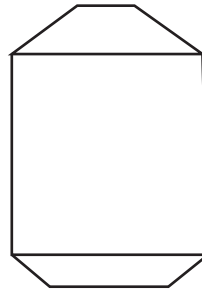

Negro
Black

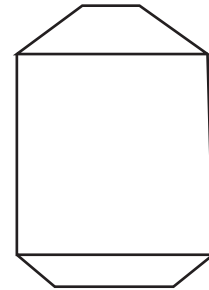

Negro
Black

SKU



JALCYGNT01



JALCYGNT02



JALCYGNG02

CONTENIDO:

- Socket reforzado con entrada E26/27 y certificación UL
- Pasacable para nipple de refuerzo para soporte del socket
- Pasacable de refuerzo para soporte del canope

INCLUDE:

- Reinforced socket with E26/27 entry and UL certification
- Cable gland for reinforcement nipple for socket support
- Reinforcement cable gland for canopy support

INSTRUCCIONES DEL PRODUCTO:

Limpiar con un paño seco y no aplicar sustancias ya que podrían dañar el producto. Al ser el yute una fibra natural, es importante no exponer la lámpara directamente al sol o lluvia porque podría disminuir su tiempo natural de vida. Se recomienda ampliamente el uso de foco LED.

PRODUCT INSTRUCTIONS:

Clean with a dry cloth and do not apply substances as they could damage the product. Since jute is a natural fiber, it is important not to expose the lamp directly to the sun or rain because it could reduce its natural life time. The use of an LED bulb is highly recommended.

JÁ

EXTRA GRANDE
EXTRA LARGE

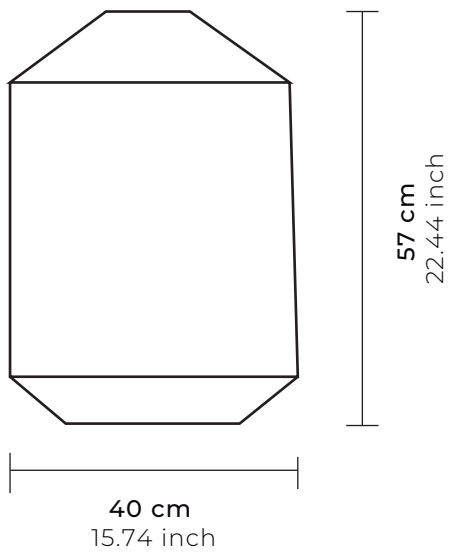

Tipo
Type

Colgante
Pendant

Técnica
Technique

Tejida y soldada a mano
Hand woven and welded

Materiales
Materials

Yute natural 2 cabos
2-ply natural jute

Socket
Socket

Plástico reforzado E26/27 Certificado UL
Reinforced plastic E26/27 UL certificate

Canope
Canopy

Aluminio 12.7cm Ø x 1.7cm alto
Aluminum 50inch Ø x 0.66 inch height

Cable
Cord

1.5m largo, Calibre 2x18
59.05inch lenght / 2x18 gauge

Medidas
Measures

40cm Ø x 57cm largo
15.74inch Ø x 22.44inch lenght

Metros cúbicos
Cubic meters

0.0912 m3
3.5905 inch

Estructura metálica
Metallic structure

Calibre 3/8 (9mm) Acabado: pintada al horno con pintura electrostática
3/8 gauge (9mm)
Finish: baked painted with electrostatic painting

Peso
Weight

2.6 kg
5.73 lb

Foco
Lightbulb

Recomendamos el uso de foco LED
We recommend the use of an LED bulb

Soporte p/socket
Socket support

Pasacable de plástico para niple
Cable gland for nipple

Soporte p/canope
Canopy support

Pasacable de plástico
Plastic cable gland

Uso
IP Rating

Interior / Semi exterior
***Se recomienda el uso de exterior siempre y cuando sea un espacio techado**
Indoor / Semi outdoor
*Outdoor use is always recommended and when it is a covered space

País de origen
Country of origin

México
México

NOTA:

JA esta hecha a mano con materiales naturales, por lo que pueden presentar variaciones en tamaño, color, forma y textura.

NOTE:

JA is handmade with natural materials, so they may present variations in size, color, shape and texture.



VARIANTES DEL MODELO

MODEL VARIANTS

CANOPE
Canopy



Blanco
White



Negro
Black



Negro
Black

CABLE
Cord



Blanco
White



Negro
Black



Negro
Black

ESTRUCTURA METÁLICA
Metallic structure

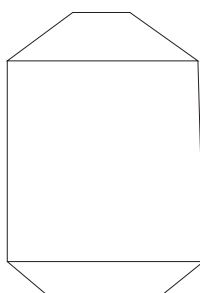

Blanco
White

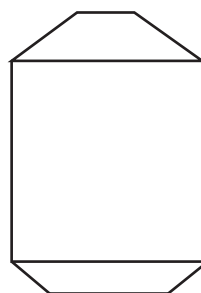

Negro
Black

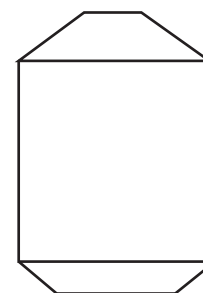

Negro
Black

SKU



JALCYENT01



JALCYENT02



JALCYENG02

CONTENIDO:

- Socket reforzado con entrada E26/27 y certificación UL
- Pasacable para nipple de refuerzo para soporte del socket
- Pasacable de refuerzo para soporte del canope

INCLUDE:

- Reinforced socket with E26/27 entry and UL certification
- Cable gland for reinforcement nipple for socket support
- Reinforcement cable gland for canopy support

INSTRUCCIONES DEL PRODUCTO:

Limpiar con un paño seco y no aplicar sustancias ya que podrían dañar el producto. Al ser el yute una fibra natural, es importante no exponer la lámpara directamente al sol o lluvia porque podría disminuir su tiempo natural de vida. Se recomienda ampliamente el uso de foco LED.

PRODUCT INSTRUCTIONS:

Clean with a dry cloth and do not apply substances as they could damage the product. Since jute is a natural fiber, it is important not to expose the lamp directly to the sun or rain because it could reduce its natural life time. The use of an LED bulb is highly recommended.