

# PMV 50

Microwave Moisture Analyzer

## USER MANUAL

IMMU-98-02-05-19-EN



Congratulations and thank you for selecting RADWAG product.  
You have purchased a device that has been designed and manufactured to give you years of service.  
Please read this user manual carefully, this shall guarantee reliable operation.

MAY 2019

## Contents

<b>1. GENERAL INFORMATION .....</b>	<b>7</b>
<b>2. BASIC SAFETY PRECAUTIONS .....</b>	<b>10</b>
2.1. Warning Symbols and Signals .....	10
2.1.1. Warning Descriptions .....	10
2.1.2. Warning Symbols .....	10
2.2. Safety Precautions .....	11
2.3. Intended Use.....	12
2.4. Good Weighing Practice .....	12
2.5. Precautions .....	13
2.6. Warranty .....	13
2.7. Supervision over Metrological Parameters.....	13
2.8. User Manual Significance.....	13
2.9. Staff Competence .....	14
2.9.1. Protective Clothing .....	14
<b>3. TRANSPORT AND STORAGE.....</b>	<b>15</b>
3.1. Delivery Check .....	15
3.2. Packaging .....	15
3.3. Microwave Moisture Analyzer Transport.....	15
<b>4. UNPACKING AND INSTALLATION.....</b>	<b>16</b>
4.1. Place of Use .....	16
4.2. Unpacking.....	16
4.3. Leveling.....	16
4.4. Standard Delivery Components List .....	17
4.5. Maintenance Activities .....	17
4.6. Connecting the Moisture Analyzer to the Mains.....	18
4.7. Connecting Peripheral Equipment .....	18
<b>5. START-UP .....</b>	<b>19</b>
5.1. Temperature Stabilization Time.....	19
5.2. Shutdown .....	19
<b>6. OPERATION PANEL .....</b>	<b>20</b>
<b>7. PROGRAM .....</b>	<b>20</b>
<b>8. HOME SCREEN.....</b>	<b>21</b>
8.1. Drying Result Window.....	21
8.2. Drying Process Window .....	22
8.3. Drying Result .....	23
<b>9. LOG IN OPERATION .....</b>	<b>23</b>
<b>10. OPERATING THE MENU .....</b>	<b>24</b>
10.1. Operation Panel .....	24
10.2. Return to Weighing .....	24
<b>11. ADJUSTMENT .....</b>	<b>25</b>
11.1. External Adjustment.....	25
11.2. User Adjustment .....	25
11.3. Scheduled Adjustments.....	25
11.4. Report Printout .....	27

11.5. GLP Project .....	27
11.6. Adjustment History .....	27
<b>12. OPERATORS .....</b>	<b>28</b>
<b>13. ADMINISTRATOR PANEL .....</b>	<b>29</b>
13.1. Password Settings .....	29
13.2. Operator Accounts Settings .....	30
13.3. Permissions Management .....	31
<b>14. PROFILES.....</b>	<b>32</b>
14.1. Creating a Profile .....	32
14.2. Profile Structure.....	33
Settings .....	34
Working modes .....	34
Readout.....	34
Units.....	35
<b>15. WORKING MODES – General Information .....</b>	<b>37</b>
15.1. Select Working Mode .....	37
15.2. Working Mode Parameters.....	37
15.3. Quick Access Buttons.....	38
15.3.1. Proximity Sensors.....	38
15.4. Information.....	39
15.5. Weighing Printouts .....	39
15.6. Profiles .....	40
<b>16. WEIGHING .....</b>	<b>41</b>
16.1. Weighing Unit Selection .....	41
16.2. Good Weighing Practice .....	41
16.3. Leveling.....	42
16.4. Zeroing .....	42
16.5. Taring .....	42
16.6. Additional Parameters for a Weighing Process .....	43
16.7. Minimum Sample Weight.....	45
16.8. Cooperation with Titrators .....	47
<b>17. DRYING - GENERAL INFORMATION.....</b>	<b>49</b>
17.1. Samples Preparation.....	49
17.1.1. Moisture Content Measurement .....	49
17.1.2. Sampling and Preparation.....	49
17.2. DRYING PARAMETERS SELECTION.....	50
17.2.1. Selecting Optimum Sample Mass .....	50
17.2.2. Influence of Sample Mass on Measurement Result Repeatability .....	50
17.2.3. Microwaves Power .....	51
17.2.4. Drying Profile Selection .....	51
17.2.5. Drying Time Selection .....	52
<b>18. DRYING PROCESS .....</b>	<b>53</b>
18.1. Drying Profile Start-Up.....	53
18.2. Drying Parameters Settings .....	53
18.2.1. Using Fields Visible on the Home Screen .....	53
18.2.2. Use of <Settings> Menu.....	58
18.2.3. Using Database of Drying Programs .....	61
18.3. Drying Profile Printouts .....	62
18.4. Performed Drying Process Report .....	64

18.5. Drying Process Performance .....	64
18.6. Drying Process Graph .....	68
<b>19. DATABASES.....</b>	<b>70</b>
19.1. Database Connected Operations.....	70
19.2. Products .....	72
19.3. Weighing Records .....	72
19.4. Customers .....	73
19.5. Drying Programs .....	73
19.6. Drying Reports .....	74
19.7. Drying Reports Statistics.....	75
19.8. Minimum Sample Weight.....	77
19.9. Ambient Conditions .....	78
19.10. Packaging .....	78
19.11. Warehouses .....	79
19.12. Printouts.....	79
19.13. Universal Variables.....	81
19.14. Databases Management.....	81
19.14.1. Export Weighing Database to a File .....	82
19.14.2. Delete Databases .....	83
19.14.3. Delete Weighings and Reports .....	84
<b>20. COMMUNICATION .....</b>	<b>85</b>
20.1. RS 232 Settings.....	85
20.2. ETHERNET Settings .....	85
20.3. Wi-Fi Settings.....	85
20.4. TCP Settings.....	86
<b>21. PERIPHERALS .....</b>	<b>87</b>
21.1. Computer .....	87
21.2. Printer .....	88
21.3. Barcode Scanner .....	89
21.3.1. Port .....	90
21.3.2. Prefix/Suffix .....	90
21.3.3. Field Selection .....	90
21.3.4. Test .....	91
21.4. Transponder Card Scanner .....	92
21.5. Additional Display .....	92
<b>22. INPUTS/OUTPUTS.....</b>	<b>93</b>
<b>23. MISCELLANEOUS.....</b>	<b>95</b>
23.1. Interface Language .....	95
23.2. Date and Time .....	95
23.3. „Beep“ Sound .....	96
23.4. Volume.....	96
23.5. Sleep Mode .....	96
23.6. Display Brightness.....	96
23.7. Touch Panel Calibration.....	97
23.8. Vibrations Detection .....	97
23.9. Level Control .....	97
23.10. Proximity Sensors Sensitivity.....	98
23.11. Proximity Sensors Timeout .....	98

23.12.	Autotest .....	98
23.13.	Start-Up Logo.....	98
23.14.	Export of System Events .....	98
<b>24.</b>	<b>UPDATE.....</b>	<b>99</b>
<b>25.</b>	<b>ABOUT (system info) .....</b>	<b>100</b>
<b>26.</b>	<b>VIDEOS .....</b>	<b>100</b>
<b>27.</b>	<b>COMMUNICATION PROTOCOL .....</b>	<b>101</b>
27.1.	List of Commands.....	101
27.2.	Response Format.....	103
27.3.	Manual Printout / Automatic Printout .....	118
<b>28.</b>	<b>CONNECTING PERIPHERAL DEVICES.....</b>	<b>118</b>
<b>29.</b>	<b>ERROR MESSAGES.....</b>	<b>119</b>
<b>30.</b>	<b>ADDITIONAL EQUIPMENT .....</b>	<b>120</b>
<b>31.</b>	<b>APPENDIX A - Printout Variables .....</b>	<b>120</b>
31.1.	Variables List.....	120
31.2.	Variables Formatting .....	124
<b>32.</b>	<b>APPENDIX E - ZEBRA Printer Settings.....</b>	<b>125</b>
<b>33.</b>	<b>APPENDIX E - Communication with Barcode Scanner .....</b>	<b>126</b>
<b>34.</b>	<b>APPENDIX G – Menu Structure.....</b>	<b>127</b>
<b>35.</b>	<b>APPENDIX H – Address of PMV 50 Moisture Analyzer Manufacturer</b>	
	<b>130</b>	

# 1. GENERAL INFORMATION

Microwave moisture analyzer is an alternative to halogen models and it can be successfully used wherever materials containing large amounts of water are dried, for example: dairy products, fish, meat, fruit products, syrups, creams, liquid resin. Its main advantage is significantly shorter drying time in comparison to other types of moisture analyzers. Shorter drying time is a result of use of microwaves which heat the whole sample up by volume, not just one side of it that is exposed to the heat source.

In the drying chamber there is a pan, it is used to measure the sample's mass. The sample is placed on a glass fibre filter and loaded onto the weighing pan. At the bottom of the chamber there is one end of the waveguide from where the microwaves are emitted. The other end of the waveguide is connected to the microwave generator. A respective drying program is selected depending on sample mass and its chemical composition.

The average duration of the drying process depends on the type and mass of used substance, and takes 40 seconds to 5 minutes. In contrast, drying using the traditional halogen moisture analyzer takes 5 to 40 minutes.

Dimensions:

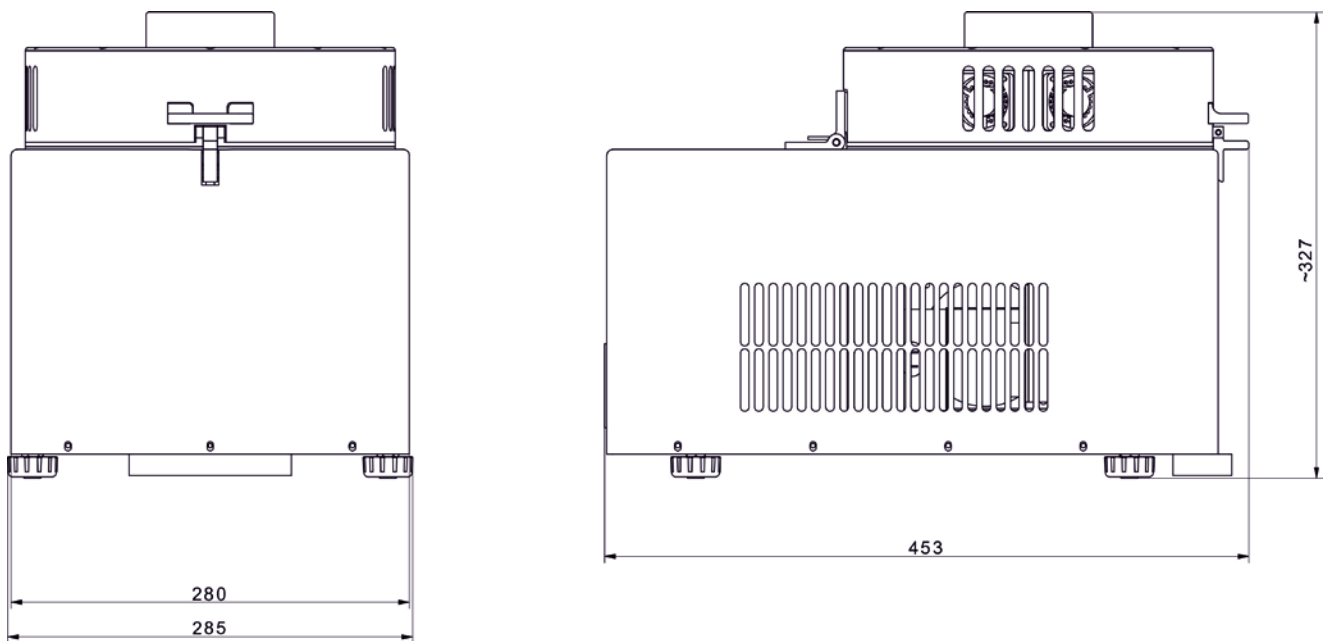

Indicator

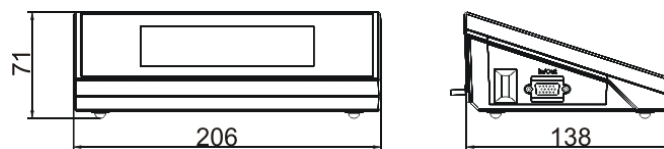

Connectors arrangement:

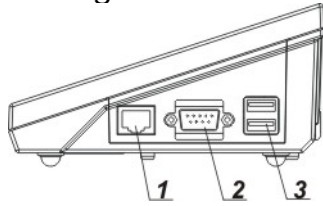

1 – Ethernet RJ45 connector  
2 – RS232 (COM1) connector

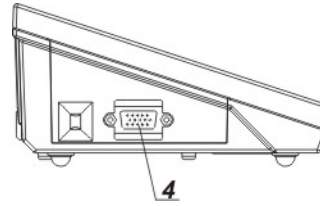

3 – USB connector  
4 – I/O, RS232 (COM2) connector

Diagrams of connection cables

**Caution:** "Ethernet – weighing device" cable is a standard network cable terminated with RJ45 connectors on both ends.

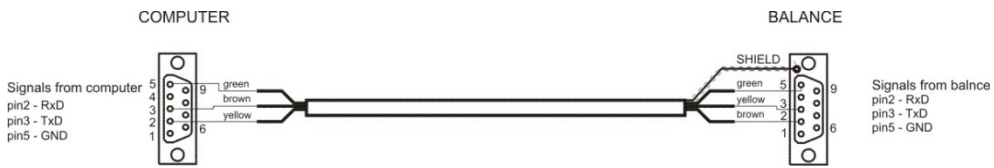

balance – computer cable (RS232)

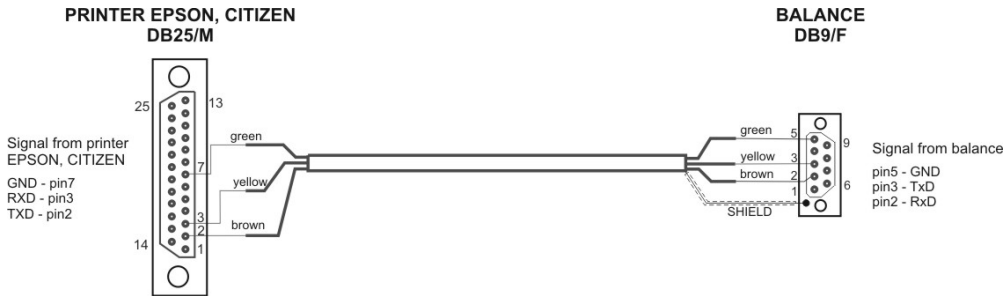

balance – printer cable (EPSON)

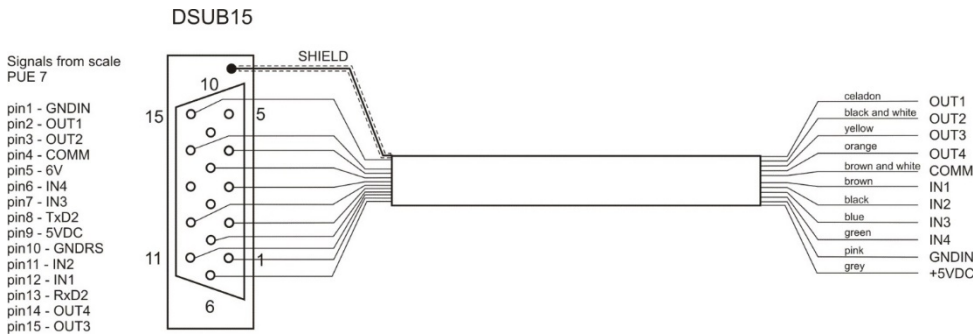

I/O cable



## TECHNICAL SPECIFICATIONS

Maximum capacity [Max]	50 g
Readability [d]	0.0001 g
Tare range	-50 g
Operating temperature	+10 - +40 °C
Moisture content readability	0.0001 %
Moisture content repeatability	0.05% (ca. 1 g sample),
Power supply	230V 50-60Hz AC
Display	5.7" (touch screen)
Communication interface	1×RS 232, 2×USB-A, Ethernet, Wireless Connection
Maximum sample weight	50 g
Heating module	microwave radiation emitter
Finish mode	4 options (time-defined, user-defined, automatic, manual)
Heating module power	800 W
Sample carrier dimensions	ø 90 mm glass fibre filter
Overall dimensions	430 × 305 × 280 mm
Net weight	20 kg
Gross weight	25 kg
Packaging dimensions	400 × 400 × 700 mm

## 2. BASIC SAFETY PRECAUTIONS

### 2.1. Warning Symbols and Signals

Safety precautions are marked with special descriptions and warning signs. They inform and warn an operator of possible dangers.

Ignoring the safety warnings may cause injuries, damage of the moisture analyzer, its inappropriate operation and errors of measurements.

#### 2.1.1. Warning Descriptions

**WARNING** Medium risk danger that can lead to a serious injury or death.

**CAUTION** Low risk danger that can lead to moisture analyzer damage or dysfunction, loss of data or minor or moderate injury.

**NOTE** Critical information on the moisture analyzer.

#### 1.1.2. Warning Symbols



Electrocution



Acid/Corrosion



Potential danger



Flammable or explosive substances



Toxic substances



Hot surface



Non-ionizing radiation

## 2.2. Safety Precautions

### WARNING

The use of PMV moisture analyser regardless of both safety information and service manual guidelines may cause health damage and even death.



#### WARNING:

Nominal voltage for a moisture analyzer is 230 VAC. It means that safety usage precautions for low voltage devices must be abide by while operating the device. Three-core power supply cable with grounding pin comes standard with a moisture analyzer. If necessary, an extension cord can be used as long as it meets the applicable standards and has a protective ground conductor. Intended disconnection of the grounding cable is forbidden.



#### WARNING:

To avoid exposure to microwave energy make sure the cover is closed prior to the drying process start. If there is an object or contamination between the sealing surfaces, remove it. If the sealing surface, latch or chamber hinge is damaged, contact service point. Repair may only be carried out by a qualified service specialist.



#### CAUTION:

When setting up the moisture analyzer leave enough space to prevent heat from building up and to keep your analyzer from overheating. Leave about 20 cm around the instrument and about 1 m above.

Air vents that are located in the housing cannot be covered, sealed or blocked in any other way.

Do not put any flammable substances on, under or near the moisture analyzer.

Be particularly careful when removing the sample from the drying chamber. The sample itself, the drying chamber, shields and the weighing pan can still be extremely hot.

In case of any maintenance work (cleaning the inside of the drying chamber), the moisture analyzer must be switched off.

Wait until all the components have cooled down.

Do not perform any modification to the heating module.

### Some types of samples require taking particular safety precautions.

They can pose a danger for people and objects. The user has to develop his own instructions concerning drying of dangerous and flammable substances. It is always the user who is liable for possible damages caused by the use of an inappropriate sample.



#### CAUTION:

**Corrosion** Substances that release aggressive vapours (e.g. acids) during the heating process. In this case, it is recommended to work with small samples. Otherwise, vapours can condense on cold housing parts and cause corrosion.



**WARNING:**

**Fire or explosion** Flammable or explosive substances, substances containing solvents or releasing flammable or explosive gases or vapours. Perform a risk analysis when in doubt relating to the sample characteristics before carrying out the procedure. For this type of samples apply the drying temperatures as low as possible to prevent flames or explosion. During the analysis it is necessary to wear protective glasses and gloves. The samples should be relatively small.

**Under no circumstances can the instrument be left unsupervised!**



**WARNING:**

**Substances containing toxic and caustic or corrosive components**

Substances that release toxic gases or vapours can cause irritations (eyes, skin or respiratory system). Due to risk of eyes, skin and lungs irritation, and due to risk of death, such samples must be dried in fume cupboard.

**Under no circumstances should the instrument be used in an area with any risk of explosion.**

**The moisture analyzer is not designed to operate in hazardous areas.**

### 2.3. Intended Use

The PMV moisture analyzer is designed to determine: relative moisture content in small samples of various substances, dry mass content in small samples and mass of weighed objects.

PMV ensures fast and precise determination process of water content in a tested sample, and application of touch screen display considerably simplifies operation and improves functionality of the moisture analyzer. A moisture analyzer can be used to determine humidity content of different materials.

At the initial stage of measurement, the device precisely determines the mass of an object placed on the carrier. As the mass reading is stabilized, the sample is quickly heated causing humidity evaporation from the tested sample.

While sampling, the moisture analyzer is continuously checking the loss of mass, and on calculation, it displays current moisture content in a tested sample.

Compared to conventional methods of humidity content determination of various substances, application of moisture analyzer considerably shortens measurement time and simplifies testing procedure.

PMV moisture analyzer allows setting multiple parameters which influence the procedure of moisture content determination in a sample, such as: power, time, drying profiles, etc.

### 2.4. Good Weighing Practice

**CAUTION!**

*It is necessary to keep the contact surfaces of the drying chamber clean.*

*Do not open the drying chamber during drying process.*

Remember that some of tested samples may become dangerous if heated (appearance of poisoning vapours, danger of ignition or explosion).

PMV moisture analyzer is not intended for dynamic weighing. Even if small amounts of a sample are added to or taken off the weighing pan, the mass readout should only be taken on stabilization of measurement result (upon displaying  pictogram).

Do not place any magnetic materials on the weighing pan. This can cause damage of the measuring system of the instrument.

Be sure to avoid impact shock and overloading the moisture analyzer in excess of the prescribed maximum measuring range (max capacity), minus any possible tare weight that has been applied.

### **Never use the moisture analyzer in an environment endangered by an explosion!**

This moisture analyzer is not adjusted for operation in explosive areas. There must not be any modification made to the moisture analyzer.

## **2.5. Precautions**

RADWAG moisture analyzer adheres to all binding safety regulations. Nevertheless there are exceptional circumstances that may cause danger.

Do not open the instrument's housing during drying. Inside there are no parts that would require maintenance, repair or replacement carried out by a user. In case of any problems, contact RADWAG service or a distributor.

Remember to use the device in accordance with this user manual, especially to follow instructions on installation and configuration of a new device.

Since use of the moisture analyzer conversely to safety precautions and service manual guidelines may be hazardous to operator's health and life, it is obligatory to read them carefully:

- Use the moisture analyzer to determine humidity content in samples and to determine mass of a tested sample; any other use of the moisture analyzer may be dangerous both to the device and the user,
- Before commissioning the moisture analyzer, make sure that the nominal power of the device specified on its data plate is compatible with the supply in the mains to which the moisture analyzer is to be plugged in,
- Protect moisture analyzer against contacts with liquids, it might lead to electrocution, fire, emission of substances containing toxic or caustic vapour, emission of explosive substances.

## **2.6. Warranty**

The warranty does not cover:

- defects being an effect of not respecting service manual guidelines,
- using the moisture analyzer conversely to its intended use,
- any modifications of a moisture analyzer or cases when its housing has been opened (damaged protective stickers),
- mechanical defects or defects caused by liquids, water and natural wear,
- defects caused by inappropriate setting or by electrical wiring failures,
- overloading of the measuring mechanism.

## **2.7. Supervision over Metrological Parameters**

Metrological parameters need to be checked in determined time intervals. Inspection frequency is conditioned by ambient conditions in which the moisture analyzer is used, kind of carried out processes and adopted quality management system.

## **2.8. User Manual Significance**

It is very important to read the service manual carefully before switching on and starting up moisture analyzer operation, even if you are experienced and have worked with this type of instrument before.

## **2.9. Staff Competence**

The moisture analyzer should be utilized and supervised only by operators who are trained and experienced in such type of instruments.

In order to use the moisture analyzer, first read the service manual. Keep these instructions for the future reference.

Do not make any design modifications. Additional equipment compatible with the moisture analyzer and spare parts should be supplied by RADWAG or an authorized distributor.

### **2.9.1. Protective Clothing**

While working with the instrument use protective clothing, this is to take safety precautions against potential hazards source of which might be tested samples and ingredients.

Use the following while carrying out tests:

- protective apron,
- protective glasses,
- protective gloves (while working with hazardous chemical substances).

Before the use of the above-mentioned protective clothing, make sure that it has been designed to be used with specific samples and that it is not damaged.

## **3. TRANSPORT AND STORAGE**

### **3.1. Delivery Check**

Upon delivery it is necessary to check the package and the device, make sure that your package bears no signs of damage.

### **3.2. Packaging**

Keep all package elements should your device be transported in the future. Remember that only original packaging can be used for shipping purposes. Prior packing, uncouple any cables, remove any separable components (carrier). The device components must be packed into an original packaging providing protection against potential damage during transportation.

### **3.3. Microwave Moisture Analyzer Transport**

1. To change the location of the device gloves with a non-slip surface are required.
2. Grab the device with both hands on the base and in the middle of the longer side, lift up and move to another location.
3. To transport the device over longer distances protective packaging for shipping is required. The packaging has to be equipped with handles facilitating lifting.

## 4. UNPACKING AND INSTALLATION

### 4.1. Place of Use

- The moisture analyzer has to be stored and operated in locations free of vibrations and shakes, free of air movement and dust and located max 2000 m above sea level.
- When setting up the moisture analyzer leave enough space to prevent heat from building up and to keep your analyzer from overheating. Leave about 20 cm around the instrument and 1 m above.
- Make sure that the ambient temperature ranges between:  $+10\text{ }^{\circ}\text{C} \div +40\text{ }^{\circ}\text{C}$ .
- Relative humidity cannot exceed 80% at the temperature of  $31\text{ }^{\circ}\text{C}$ , decreasing linearly to 50% of the relative humidity at the temperature of  $40\text{ }^{\circ}\text{C}$ .
- Place the moisture analyzer either on a robust-design table or on a wall bracket, which is both distant from heat sources and insusceptible to vibrations.
- Take special precaution while weighing magnetic objects, as part of the moisture analyzer is a strong magnet.

### 4.2. Unpacking

Carefully take the device out of the packaging, remove the foam insert and gently place the moisture analyzer at its workplace. The device is complete and does not require any additional assembling.

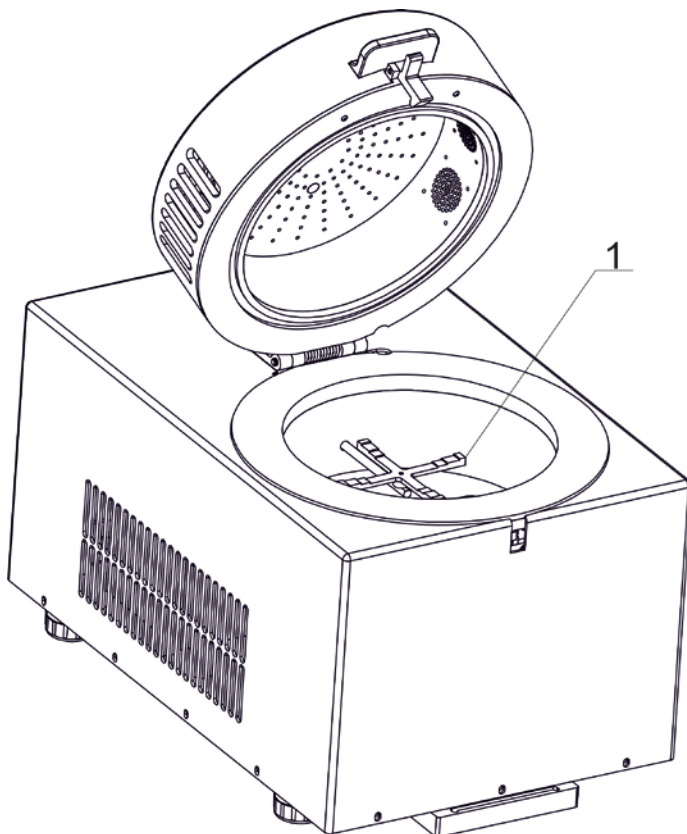

1. Cross-shaped holder on which filters with sample are placed.

### 4.3. Leveling

The moisture analyzer is equipped with an electronic leveling device exclusively (there is no external one). It is necessary to level the instrument prior connecting it to the mains. To do that, enter leveling procedure and carry out leveling. Leveling procedure is described in section 16.3 of this user manual.



#### 4.4. Standard Delivery Components List

- Moisture analyzer.
- Cross-shaped holder.
- Power cord.
- Moisture analyzer – computer cable (P0108).
- User manual - CD version.

#### 4.5. Maintenance Activities

**Prior to maintenance activities disconnect the moisture analyzer from the mains. Cleaning the cross-shaped holder while still installed may cause damage of the moisture analyzer measuring system.** Prior to maintenance activities disassembly the holder.

##### Cleaning powder-coated components:

*For preliminary cleaning process stage you need running water or wet sponge featuring large holes, this will help you to remove loose, heavy dirt.*

*Do not use products containing abrasive substances.*

*Next, using cloth and cleanser-water solution (soap, dishwashing liquid) gently rub the cleaned surface.*

*Avoid using cleanser without water since it may result with damage of the cleaned surface, please mind that large amount of water mixed with cleanser is a must.*

##### Cleaning Aluminium Components

*While cleaning aluminium components use products acid by nature, e.g. spirit vinegar, lemon. Do not use products containing abrasive substances. Avoid using hard brush, this may cause scratches. It is recommended to use microfibre cloth.*

*While polishing the surface use circular movements. Use clean, dry cloth to make the surface shine.*

##### Cleaning ABS components:

*To clean dry surfaces and avoid smudging, use clean non-colouring cloths made of cellulose or cotton. You can use a solution of water and detergent (soap, dishwashing detergent, glass cleaner). Gently rub the cleaned surface and let it dry. Repeat the cleaning process if needed.*

*In case of hard to remove contamination, e.g.: residues of adhesive, rubber, resin, polyurethane foam etc., you can use a special cleaning agents based on a mixture of aliphatic hydrocarbons that do not dissolve plastics. Before using the cleanser for all surfaces we recommend carrying out tests. Do not use cleansers containing abrasive substances.*

#### **4.6. Connecting the Moisture Analyzer to the Mains**



**The moisture analyzer can be plugged to the mains only by means of an original power cord, which comes standard with the instrument. Rated voltage (specified on the device's data plate) must be compatible with the mains rated voltage.**

The power cord can be connected only to a socket with a ground contact. Plug the power cord to the moisture analyzer. The moisture analyzer's power plug is located at the back of its housing.

#### **4.7. Connecting Peripheral Equipment**

The moisture analyzer must be unplugged from the mains before connecting or disconnecting any peripheral equipment (printer, PC computer). Use only peripheral equipment recommended by the manufacturer with your moisture analyzer. Upon connecting the peripherals, plug the moisture analyzer to the mains.

## 5. START-UP

- Plug the power cord to the moisture analyzer. Switch the moisture analyzer using main switch located at the back of its housing.
- Connect the power supply to the mains, **ON/LOAD**  diode on the operation panel lights up.
- Press  key located on the top of the operation panel. Within a few seconds the OS Windows and RADWAG software start loading, it is signalled by flickering ON/LOAD red diode.
- Upon completed start-up the home screen is displayed automatically.
- The moisture analyzer runs with no operator logged in. In order to start operation it is necessary to carry out the logging procedure (for detailed logging procedure read later sections of this service manual).

**Caution:** Before you start the moisture analyzer, make sure that there is no load on the weighing pan.

### 5.1. Temperature Stabilization Time





Before start of the measuring processes, it is necessary to wait until the platform reaches thermal stabilisation (the same as in the workroom). This is the so-called acclimatisation time. Moisture analyzers stored in much lower temperatures, than the workroom temperature, before being plugged to the mains (e.g. during winter period) must be subjected to thermal stabilisation. The thermal stabilisation period takes about 8 hours. During the thermal stabilization, the indications on the screen can change. Potential workroom temperature change shall occur gradually and slowly in the course of the weighing instrument operation.

### 5.2. Shutdown

**Caution:**

**Prior to switching off the moisture analyzer, switch off the indicator using ON/OFF key located on the operation panel.**

**Procedure:**

- Press <  > button on the moisture analyzer keypad.
- A window with buttons is displayed:
  -  Switch off (switching of the indicator - **ON/LOAD** diode is on continuously),
  -  Cancel (cancelling the procedure).
- Press <  Switch off > button.
- Switch off the main switch.
- Disconnect the power cord from the moisture analyzer socket.

## 6. OPERATION PANEL

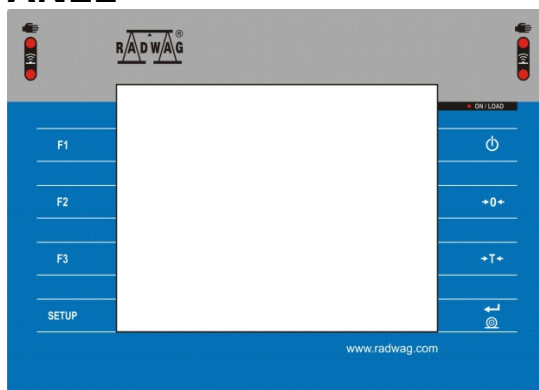

Key	Description
	Press to switch the moisture analyzer ON/OFF.
	Press to zero the moisture analyzer.
	Press to tare the moisture analyzer.
	Press to send measurement to a printer or a computer
SETUP	Press to enter the menu
F1	Programmable key, press to select working mode
F2	Programmable key, press to select operator profile
F3	Programmable key, press to carry out adjustment.

## 7. PROGRAM

Program menu is divided into function groups.

Function group is a group of interrelated parameters. For detailed description of each menu group read later sections of this user manual.

### Menu - Function Groups:

Moisture analyzer's main menu is accessed by pressing SETUP function key or button located in the bottom part of the display. The menu comprises parameters related to moisture analyzer settings, functions and profiles.

 ADJUSTMENT	 OPERATORS	 PROFILES	 DATABASES
 COMMUNICATION	 PERIPHERAL DEVICES	 INPUTS/OUTPUTS	 PERMISSIONS
 MISCELLANEOUS	 UPDATE	 ABOUT (system info)	 VIDEOS

## 8. HOME SCREEN

### 8.1. Drying Result Window

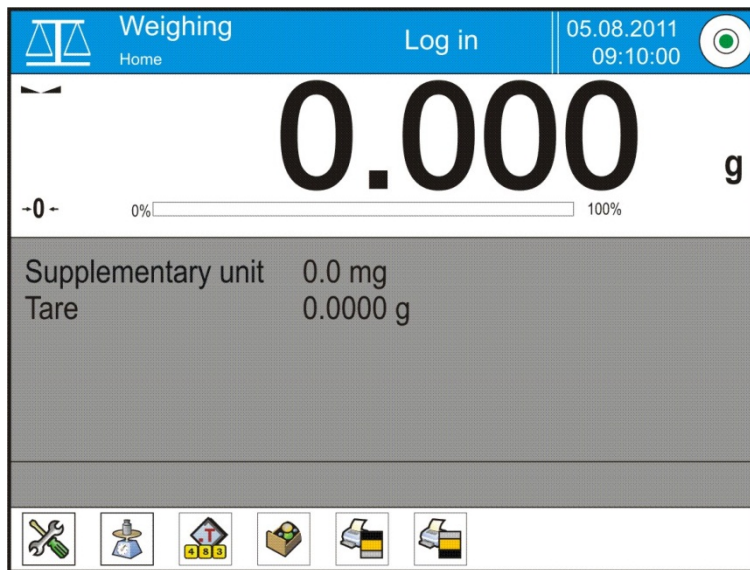

#### The home screen features 4 sections:

- Top section displaying data on active working mode, logged in operator, date, time, computer connection status and level status.

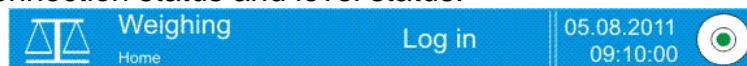

- Section presenting the weighing result:



- Section comprising supplementary information on currently performed operations (grey background).

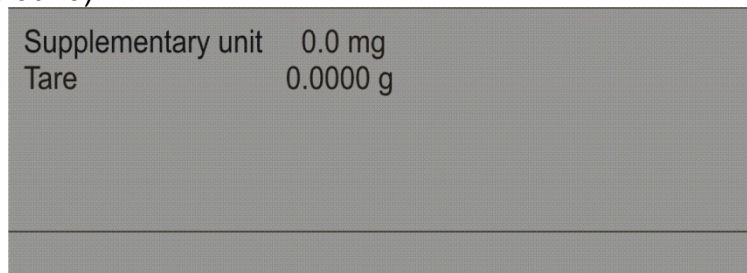

#### **Caution:**

*Data contained in this workspace is freely configurable.  
For detailed instruction read section 15.4 of this user manual.*

- Section comprising on-screen function buttons:



#### **Caution:**

*The operator can define the on-screen function keys. For detailed instruction read section 15.3 of this user manual.*

## 8.2. Drying Process Window

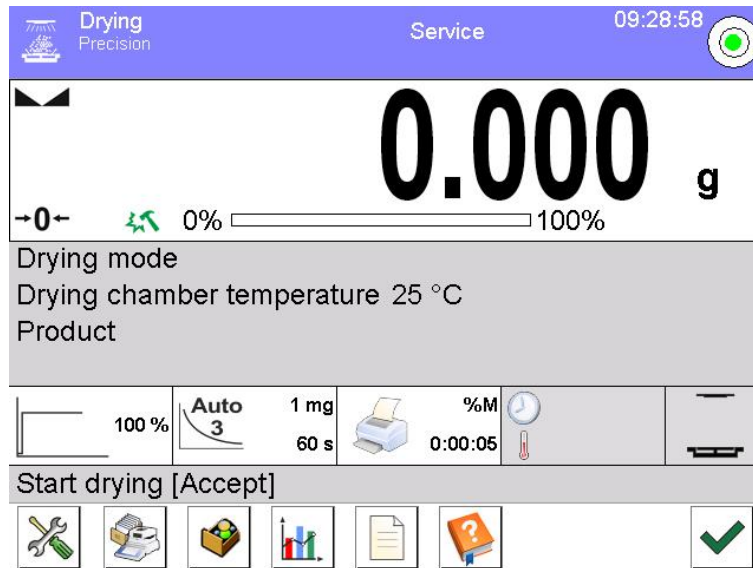

### The home screen features 4 sections:

- Top section displaying data on active working mode, logged in operator, date, time, computer connection status and level status.



- Section presenting the weighing or drying result:

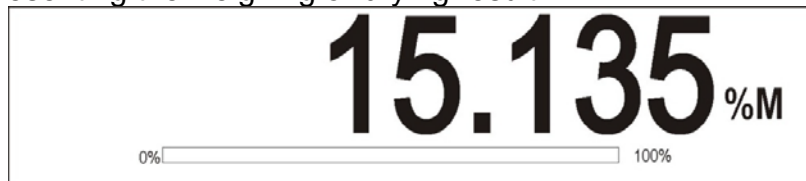

- Section comprising supplementary information on currently performed operations (grey background).



### Caution:

*Data contained in this workspace is freely configurable.*

*For detailed instruction read section 15.4 of this user manual.*

- Section comprising supplementary information on drying parameters and current status of the moisture analyzer:



- Section comprising on-screen function buttons:



### Caution:

*The operator can define the on-screen function keys. For detailed instruction read section 15.3 of this user manual.*

### 8.3. Drying Result

Drying results is presented on the home screen. The result can be enlarged so that it can be seen from a larger distance.

#### Procedure:

To enlarge display indication press the white field with the result.

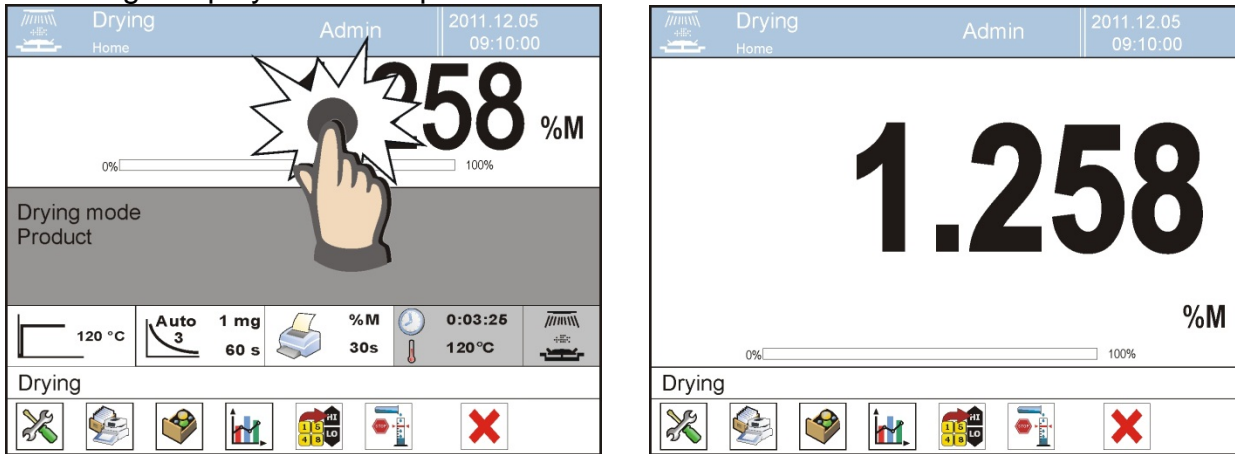

Press the white field with the result again to return to the standard display. The screen will return to its original size.

## 9. LOG IN OPERATION

In order to access operator-related parameters and in order to edit databases, you need to log in as an operator with **<Administrator>** permissions levels.

#### First log in operation:

- Go to home screen, press **<Log in>** button, wait for the operators database and **<Admin>** entry to open.
- Select **<Admin>** operator, Wait for the on-screen keyboard with a password box to open.
- Enter „1111” password and press  key to confirm.
- The home screen is displayed, **<Log in>** sign is replaced by **<Admin>** sign.
- If necessary enter your name and password and assign permissions to the administrator so that no one else can enter unauthorized changes in the settings.
- Enter operators and assign their permissions and passwords (*for detailed procedure read section: 12 and 13*).

While logging in again, select an operator from the list and enter the password; the program initiates operation with permissions set for the selected operator.

#### Log Out operation:















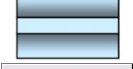

- Go to home screen, press logged operator name, wait for the operators database to open.
- Select **<Log out>** option ( 1st position on the operators list).
- Home screen is displayed, logged in operator name is replaced with **<Log in>** entry.



## 10. OPERATING THE MENU

Due to a touch screen, operation of the menu is intuitive and simple. Pressing a function button or an area on the display initiates an assigned function or process.



### 10.1. Operation Panel

	or		Press to enter the main menu
			Press to scroll the menu 'up'
			Press to scroll the menu 'down'
			Press to scroll the menu 'up-down' fast
			Press to confirm modification
			Press to exit, function remains unmodified
			Press to add a new record to a database
			Press to search for a particular record in a database by date
			Press to search for a particular record in a database by name
			Press to search for a particular record in a database by code
			Press to print out a particular record from a database
			Press to clear the editing field
			Press to enable/disable an on-screen keyboard
			Press to read printout template from a file format *.lb (function key is active on inserting a USB flash drive to terminal's USB port)
			Press to select variables for a printout from a list
			Press to move (exit) one level up

### 10.2. Return to Weighing

Modifications introduced into moisture analyzer memory, are automatically saved upon return to weighing operation.

#### Procedure:

- Press  button repeatedly, keep pressing until you see home screen.
- Press  button, the home screen is displayed immediately.







## 11. ADJUSTMENT

The moisture analyzer features automatic internal adjustment system which ensures correct measurement accuracy. <ADJUSTMENT> menu contains functions controlling operation of module adjustment process. The menu contains elements which are described in the following sections.

### 11.1. External Adjustment

External adjustment is carried out using an external mass standard of the right accuracy and weight value, which value depends on weighing device model and capacity. Correction is carried out semi-automatically, successive process stages are signalled with prompts.

#### Procedure:

- Enter <ADJUSTMENT> submenu, next press:  External adjustment> parameter.
- Message to remove weight is displayed. Unload the weighing pan and press  button. The moisture analyzer determines start mass, message: **Start mass determination** is displayed.
- Load the weighing pan with weight of respective mass value, and press  button.
- Upon completed procedure, unload the weighing pan and press  button to confirm. Moisture analyzer returns to the weighing process.

### 11.2. User Adjustment

User adjustment can be carried out using any adjustment weight mass of which ranges between 0.15 Max and Max. User adjustment and external adjustment procedures are likewise with one exception, before user adjustment start, an edit box for entering mass of the used adjustment weight is opened.

Enter <Adjustment> submenu,  User adjustment> option. Then follow the commands displayed on the screen.

### 11.3. Scheduled Adjustments

< Scheduled adjustments> parameter allows you to precisely specify time for adjustment performance and interval between successive adjustments. The parameter is not connected with automatic adjustment and its criteria (time, temperature). You can schedule when internal and external adjustment are to be performed. In order to design schedule for external adjustment, it is necessary to record mass standards for adjustment performance into moisture analyzer memory.

#### Procedure:

Prior setting adjustment schedule, enter data of mass standards intended for external adjustment performance. Enter operator menu, select <Adjustment> submenu and find

< Adjustment weights> parameter. Enter weight data:

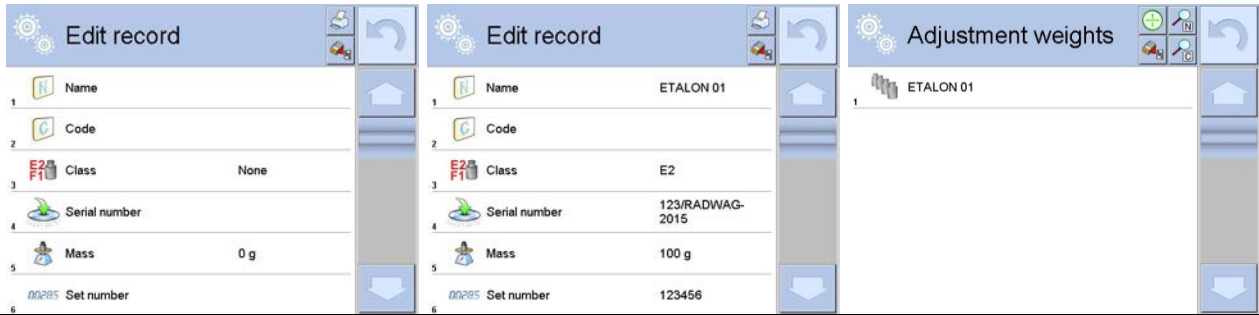

	<p>Enter operator menu, select &lt;Adjustment&gt; submenu and find &lt;Scheduled adjustments&gt; parameter.</p>
--	---

	<p>Enter &lt;Scheduled adjustments&gt; parameter, wait for 'Scheduled adjustments' window to open, add adjustment procedures. Remember, only Administrator can add new entries.</p>
--	---

	<p>In order to add a new position, press  button, wait for a window with data on scheduled adjustment to open.</p>
--	--

	<p>Select task: External Adjustment</p>
--	---

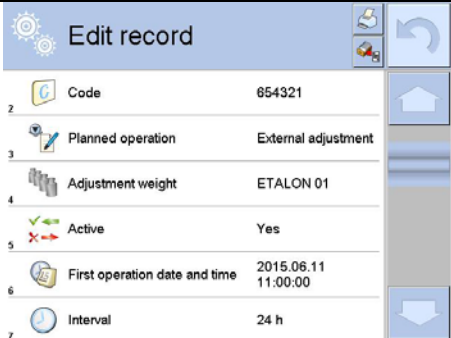
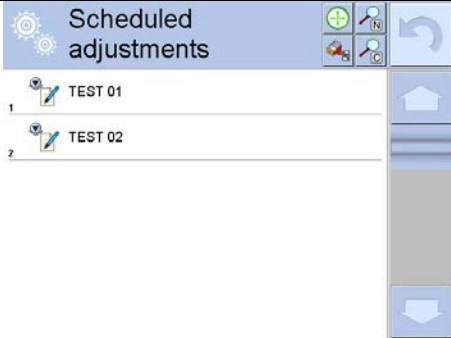
	<p>For external adjustment option, enter data on the adjustment, mass standard used for the adjustment performance and its schedule.</p>
	<p>When all necessary data has been introduced, return to the previous window. The window features newly added entry.</p>

Upon entering all data exit the menu. Now all the adjustments are carried out automatically as scheduled and with specified time intervals.

### 11.4. Report Printout

<Report printout> parameter determines whether or not an adjustment report is to be automatically printed upon adjustment process completion. In order to set automatic report printout, go to <🖨️ Report printout> parameter and select <YES> entry.

### 11.5. GLP Project

GLP is one of many methods for documenting work in accordance with adopted quality system. Data selected for printing is printed on each release of an adjustment report.

Information and signs to be used in a GLP report:

<ul style="list-style-type: none"> <li>▪ adjustment (adjustment type)</li> <li>▪ working mode (working mode name)</li> <li>▪ date, time</li> <li>▪ operator</li> </ul>	<ul style="list-style-type: none"> <li>▪ balance type</li> <li>▪ balance S/N</li> <li>▪ level status</li> <li>▪ nominal mass</li> <li>▪ current mass</li> <li>▪ difference</li> </ul>	<ul style="list-style-type: none"> <li>▪ temperature</li> <li>▪ empty line</li> <li>▪ dashes</li> <li>▪ signature</li> <li>▪ non-standard printout</li> </ul>
--	---	---

### 11.6. Adjustment History

Adjustment history contains data on all carried out adjustment processes. The record is carried out automatically. Each record on adjustment comprises basic data on completed process.

This menu enables displaying the list of completed adjustment processes.

Each report is printable.

In order to print an adjustment report, enter <Adjustment> submenu, next enter <Adjustment history>, select adjustment to be printed. Upon displaying record details, press <🖨️> print key located on the top of the display.

**Caution:** *If the moisture analyzer memory is full, the oldest record gets automatically deleted.*

If internal procedures of an organization require maintaining complete documentation concerning all carried out adjustment processes, then the list with adjustment records has to be printed and archived periodically.

### **Searching for adjustment record**

The module enables searching for a specific completed adjustment record. To do that, press



search pictogram and enter date of adjustment process that is to be found. The software automatically searches for data and displays it on the screen.

### **Exporting data on completed adjustment process**

To export data on carried out adjustments, connect a USB flash drive to moisture analyzer's USB port. Press <Data export> button located on the top of the display. The process is fully automatic and on its completion a file with .tdb extension is saved on a USB flash drive connected to the USB port. The file can be edited using Excel or Text Editor.

## **12. OPERATORS**

Operators database features list of operators permitted to operate the weighing device. The following data can be defined for each moisture analyzer operator:

- Name
- Code
- Password
- Permissions
- Language
- Profile
- Card no.

### **New operator can be added by the Administrator exclusively.**

Procedure:

- Enter <Operators> menu, press < Add> button.
- Define all necessary data.

### **Caution:**

*It is possible to search for an operator in a database of operators by code or name.*

### **Editing data on an operator:**

- Press field with operator name.
- Data on a specific operator is displayed.
- Select and change necessary data.

### **New operator can be deleted by the Administrator exclusively.**

To delete an operator:

- Press and hold operator name.
- Database menu is displayed.
- Select <Delete> parameter.

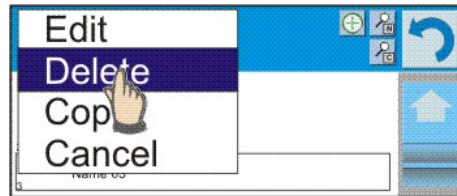
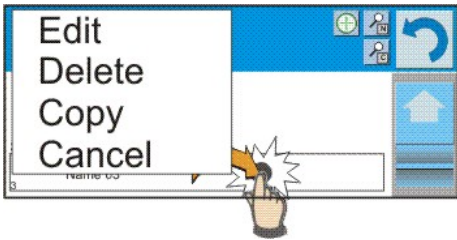

### 13. ADMINISTRATOR PANEL

This menu  enables to determine: activities to be carried out by an operator with certain permissions, password strength and permissions for unlogged operator.

*Caution: Only operator with Administrator permissions can modify permission-related parameters.*

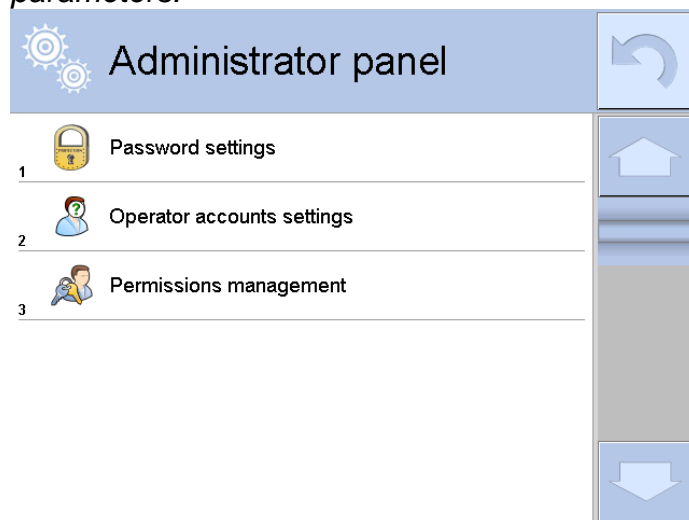

#### 13.1. Password Settings

A menu group that enables specifying password strength for moisture analyzer operators.

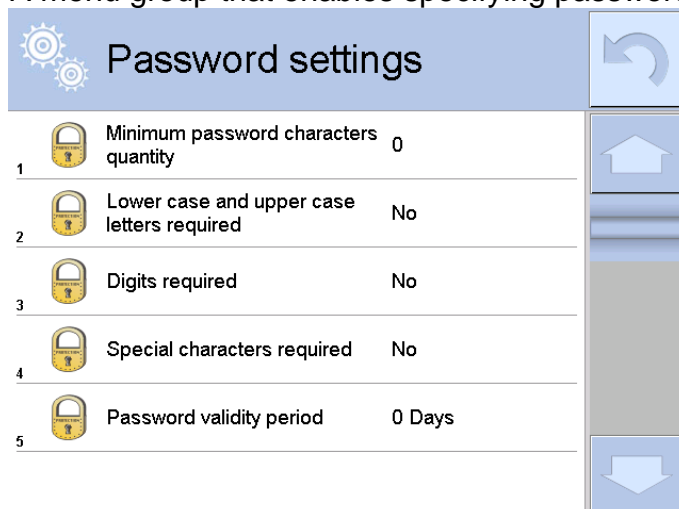

Minimum password characters quantity

Lower case and upper case letters required

Determining quantity of characters in operator's password.  
For '0' value set any quantity of characters.  
Determination of the requirements for operators' passwords.

Digits required

Special characters required  
Password validity period

Determining time interval in days after which the password has to be changed.  
For '0' entry password change is not required.

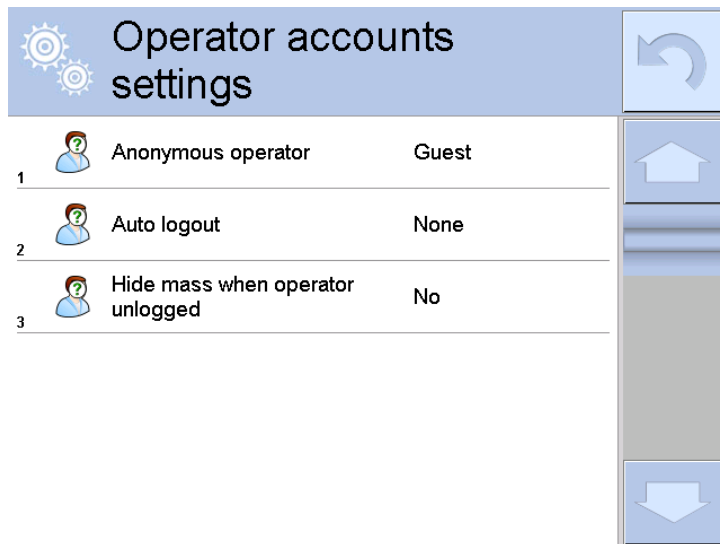

### 13.2. Operator Accounts Settings



#### Unlogged operator permissions

Administrator can assign an unlogged weighing device operator (so called anonymous operator) with permissions level.

##### Procedure:

- Enter < Permissions> menu.
- Select < Anonymous operator> parameter.
- Set appropriate permissions for the anonymous operator.
- Set one of four options: Guest, Operator, Advanced operator, Administrator.

##### Caution:

When <**Guest**> entry is set, the software settings cannot be modified by unlogged operator.

#### Auto Logout













With Auto logout function on, the operator is logged out automatically if the moisture analyzer is not operated within a specified time interval, given in minutes. By default the function is disabled (<None> entry set).

##### Procedure:

Enter < Permissions> submenu, select < Auto logout> entry, next set respective permissions: none/3/5/15/30/60. Time given in [min].

## 13.3. Permissions Management

### Databases

Permissions management			Database		
1	 Database		1	 Databases preview	Operator
2	 Date and time	Operator	2	 Products	Administrator
3	 Printouts	Administrator	3	 Customers	Administrator
4	 Header printout	Operator	4	 Formulations	Administrator
5	 Footer printout	Operator	5	 Packaging	Administrator
6	 Printout / Enter key	Operator	6	 Warehouses	Administrator

Default moisture analyzer settings enable operator who is logged as **Administrator** to modify databases. The software allows to change permissions to databases modification.

#### Procedure:

- Enter < Administrator panel> submenu, select <Databases> entry, next set respective permissions.
- Set one of four options: Guest, Operator, Advanced operator, Administrator.



#### Caution:

When <**Guest**> entry is set, settings are freely accessed (there is no need to log in).

### Date and Time

Default moisture analyzer settings enable operator who is logged as **Administrator** to modify date and time parameter. The software allows to change permissions, and as a result authorize other operators to access < Date and time> parameter.

#### Procedure:

- Enter < Permissions> menu.
- Select << Date and time> parameter.
- Set one of four options: Guest, Operator, Advanced operator, Administrator.



#### Caution:

When <**Guest**> entry is set, all unlogged operators can access date and time settings.

### Printouts

Default moisture analyzer settings enable operator who is logged as **Administrator** to edit printouts. The software allows to change permissions, and as a result authorize other operators to access < Printouts> parameter.

#### Procedure:

- Enter < Permissions> menu.
- Select < Printouts> parameter.
- Set one of four options: Guest, Operator, Advanced operator, Administrator.



#### Caution:

When <**Guest**> entry is set, all unlogged operators can edit printouts.

## Value release

Default moisture analyzer settings enable operator who is logged as **Operator** to carry out printouts. The software allows to change permissions, and as a result authorize other operators to access < Value release> parameter.

### Procedure:

- Enter < Permissions> menu.
- Select < Value release> parameter.
- Set one of four options: Guest, Operator, Advanced operator, Administrator.



**Caution:** When <**Guest**> entry is set, all unlogged operators can edit value release.

## Videos

Default moisture analyzer settings enable operator who is logged as **Administrator** to modify <Videos> submenu (add, delete files). Providing that respective modifications have been introduced by the Administrator, it is possible for remaining operators to access

< Videos> menu options too.

### Procedure:

- Enter < Permissions> menu.
- Select < Videos> parameter.
- Set one of four options: Guest, Operator, Advanced operator, Administrator.

**Caution:** When <**Guest**> entry is set, <Videos> submenu is freely accessed (there is no need to log in).

## 14. PROFILES

A Profile is a data pack that determines:

- e.g. parts counting, percent weighing, etc.
- data to be displayed during operation,
- function keys to be active,
- measuring units to be accessible
- criteria determining speed of operation and measurement stability,

Moisture analyzer software allows you to create numerous profiles, this enables:

- designing an individual working environment by each operator,
- customized moisture analyzer operation, i.e. activating selected function keys and information (improved operation performance).

### 14.1. Creating a Profile

Default profile: <Home>. The Administrator can create new profiles by:

- Copying an already existing profile and modifying it,
- Creating a new profile.





## Copying an existing profile

### Procedure:

- Enter the main menu, to do it press **Setup** key.
- Enter <Profiles> submenu.
- Press and hold profile that is to be copied.
- Menu referring to a profile record is displayed. Select <Copy> parameter.
- A new <Copy name> profile is created, new profile settings and base profile settings are identical.
- Modify necessary data: (name, etc.).

## Adding a new profile

### Procedure:

- Enter the main menu, to do it press **Setup** key.
- Enter <Profiles> submenu.
- Press  button, message box: <Create new record?> is displayed.
- Press  button to confirm. The software automatically adds a new record and enters its editing mode.

## Deleting a profile

### Procedure:

- Enter the main menu, to do it press **Setup** key.
- Enter <Profiles> submenu.
- Press and hold profile that is to be deleted.
- Menu referring to a profile record is displayed. Select <Delete> parameter.
- Message box: <Delete?> is displayed.
- Press  button to confirm, the profile gets deleted.

### Caution:

*In order to operate profiles it is necessary to log in as an Administrator.*

## 14.2. Profile Structure

Profile parameters list:

<b>Settings</b>	Enter this menu to set an individual profile name (an order of alphanumeric characters), and to declare a default working mode (the selected mode is activated as default upon selecting the profile).
<b>Working modes</b>	Contains the following submenus: <ul style="list-style-type: none"><li>▪ Additional settings of a working mode</li><li>▪ Control</li><li>▪ Information</li><li>▪ Printouts</li></ul>
<b>Readout</b>	Contains the following submenus: <ul style="list-style-type: none"><li>▪ Filter</li><li>▪ Value release</li><li>▪ Autozero</li><li>▪ Autozero: Dosing</li><li>▪ Last digit</li></ul>
<b>Units</b>	Enter this menu to declare the start unit, the supplementary unit, 2 custom units and to enter the value of gravitational acceleration force in moisture analyzer's operation place.

## Settings

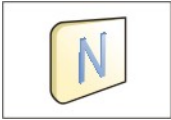

### Name

Upon entering this parameter, a message box with an on-screen keyboard is displayed. Enter the name of a profile and press  button to confirm. The name is assigned to the profile.



### Default working mode

Upon entering this parameter you can select a specific working mode that is to be set as default. For <None> parameter set, upon selecting the profile, the moisture analyzer activates the most recently used working mode.

## Working modes

Upon entering Working Modes parameter, a window containing all accessible working modes is displayed. Parameters are set for each working mode independently. Particular profile when activated runs with given set of parameters.

You can enter the following data for each working mode:

- **Settings:**  
contains specific parameters relating to a working mode and universal settings, such as: result control, tare mode, automatic footer printout, printout mode, printout.
- **Quick access buttons:**  
declaring quick access buttons to be displayed.
- **Information:**  
declaring information to be displayed.
- **Printouts:**  
declaring type of a printout or defining a non-standard printout.

## Readout

The function enables you to adjust moisture analyzer operation to ambient conditions (filter settings) or your individual needs. <Readout> menu contains the following elements:

### **FILTER**

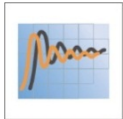

Each measurement signal before being displayed is electronically processed in order to provide correct parameters specific for stable measurement result, i.e. ready to read.

You can determine signal processing rate, there are five different filters for you to select from. Range:

- very fast, fast, average, slow, very slow.

While setting the filter consider the actual operating conditions. In case of very good operating conditions select average or fast filter. For harsh operating conditions select slow or very slow filter.

### **Caution:**

- *for precision balances set: very fast ÷ or average filter,*
- *for analytical balances and microbalances set: ÷ very slow filter.*



### **Value release**

The parameter has been designed to determine when the stability marker is to be displayed.

There are three different settings for value release parameter:

- o fast, fast and reliable, reliable.



**Caution:**

*Both parameters, filter and value release, determine how long it takes to obtain stable result.*



**Autozero Function**

The function has been designed to enable automatic control and correction of zero indication.

If the function is enabled, the subsequent measurement results are compared to each other in constant time intervals. If the results differ less than declared AUTOZERO range, e.g. 1 division, the moisture analyzer is automatically zeroed, and the pictograms of stable indication –  and precise zero –  are displayed. Active Autozero function means, that each measurement starts with the precise zero. There are, however, some cases when this function can be a disturbing factor for the measuring process, e.g. very slow placing of a load on the weighing pan (load adding, e.g. pouring, filling). In such case, the system correcting zero indication may also correct the actual indication of a load placed on the weighing pan.

Accessible settings: **NO** - autozero function disabled  
**YES** - autozero function enabled



**Autozero function: Dosing**

The function has been designed to set autozero to default value selected for dosing.

Options:

- NO** - autozero operation is automatically disabled on entering dosing mode.
- YES** - autozero operation is automatically enabled on entering dosing mode.



**Last digit**

The function has been designed to enable/disable visibility of the last decimal place of measurement result. Accessible settings:

- **Always:** all digits are displayed.
- **Never:** last digit disabled.
- **When stable:** last digit displayed only when the result is stable.

**Ambient Conditions**

Parameter relating to ambient and environmental conditions of the workstation. For unstable ambient conditions it is advisable to set the parameter to value: Unstable. By default the parameter is set to value: Stable.



Setting 'Stable' value results with faster operation, i.e. weighing takes much less time than in case of setting the parameter to value: Unstable.

Available options:

- **Unstable, Stable.**

**Units**

For a selected profile you can declare start unit, supplementary unit and two custom units.

A custom measuring unit features:

- multiplier,
- a name (3 characters).

Upon completed operation of designing a custom unit its name is added to the list of accessible measuring units.

Units menu enables you to enter the value of gravitational acceleration force characteristic for a place of use. It is obligatory should a moisture analyzer be used to determine mass in [N].

## 15. WORKING MODES – General Information

PMV series moisture analyzers feature the following working modes:



### Weighing

Means of operation: weight of a load is determined through an indirect measurement. The moisture analyzer measures gravitational force which attracts the load. The obtained result is processed and displayed on the moisture analyzer screen in a digital format.



### Drying

Means of operation: The moisture content value is obtained via evaporation of moisture from sample placed inside of the drying chamber. The result is calculated automatically (and displayed) in real time, the calculation is made on the basis of sample mass at the beginning, in the course, and at the end of the process.

<DRYING> mode feature specific settings. The settings enable adapting mode operation to your individual needs. They are activated upon selecting a respective profile. For detailed description of the mode read later sections of this user manual.

### 15.1. Select Working Mode

To run working mode other than currently operated one:

- Press active working mode name.

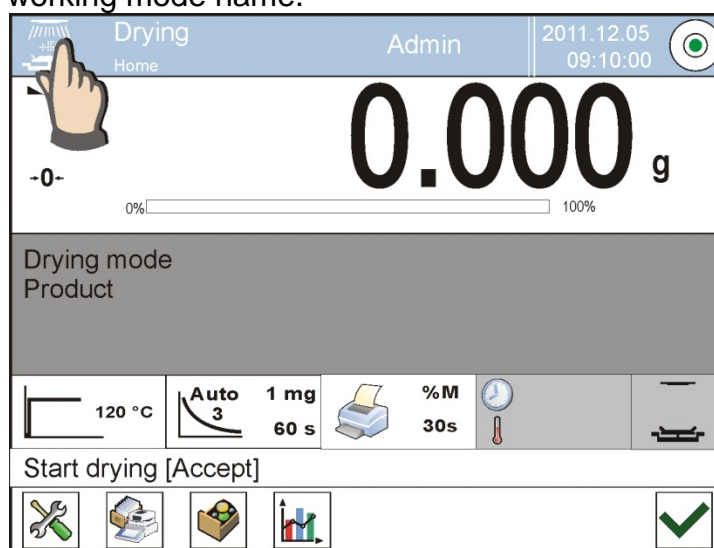

- List of working modes is displayed.
- Select the mode that is to be operated.

### 15.2. Working Mode Parameters

Each working mode has programmable parameters determining its functioning. To access particular working mode parameters:

1. Press grey workspace area.
2. The following menu is displayed:
  - <Settings> - additional options.
  - <Keys> - defining quick access buttons .
  - <Information> - selecting information to be displayed in the workspace.
  - <Printouts> - selecting printout type and content.
  - <Profile> - selecting a profile to be active in the course of operation .

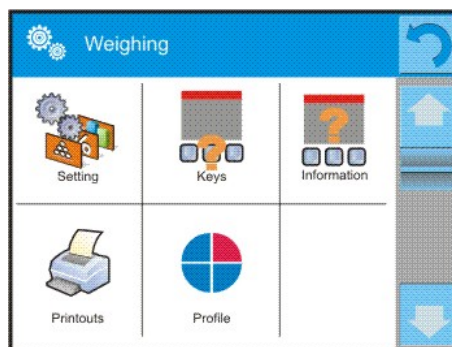
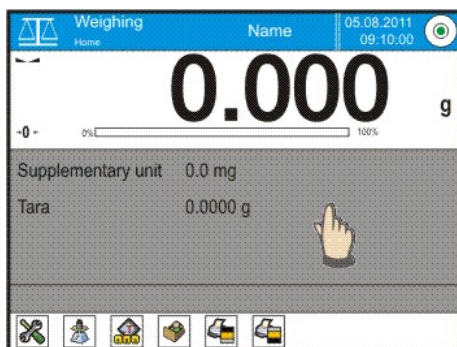

3. Enter particular submenu and select the component that is to be modified

For detailed information on parameters of <Settings> menu go to section 16.6 *Additional Parameters for a Weighing Process*. For detailed overview of drying profile's parameters read section providing information on the drying profile.

### 15.3. Quick Access Buttons

You can define up to 7 quick access buttons, which are to be displayed in the bottom bar. Upon assigning a function to a button a corresponding pictogram is displayed in the bottom navigation bar of the home screen.

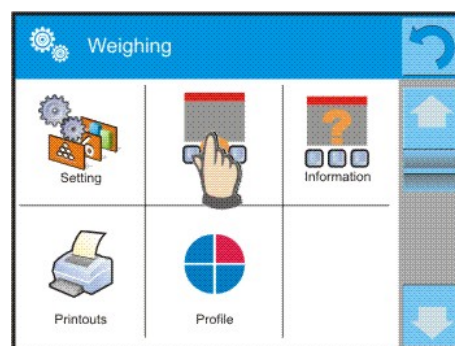

These are so called quick access buttons for triggering the most often performed operations.

**Caution:**

You can view user manual saved to moisture analyzer memory. In order to take advantage of this function add help button to a tool bar .

#### 15.3.1. Proximity Sensors

The moisture analyzer features two proximity sensors enabling touch-free module control. The program detects four motions performed around the sensors:

1. Hand in a close vicinity to the left sensor <**Left sensor**>.
2. Hand in a close vicinity to the right sensor <**Right sensor**>.
3. Hand motion to the left (<**Proximity sensor: gesture to the left**>).
4. Hand motion to the right (<**Proximity sensor: gesture to the right**>).

**CAUTION:**

Using GESTURE TO THE LEFT or GESTURE TO THE RIGHT, it is necessary to remember that <Proximity sensors delay> parameter must be set to value **500 ms**!

List of operations to be assigned: None; Profile; Adjustment; Zeroing; Taring; Tare setting; Disable tare; Enable tare; Packaging; Print; Header printout; Footer printout; Unit; Universal variable 1; Universal variable 2; Universal variable 3; Universal variable 4; Universal variable 5; Accept; Abort; Operator; Left door; Right door; Open/close door; Parameters; Product; Warehouse; Customer.



Upon completed configuration procedure, the software runs function assigned to a particular proximity sensor, having detected motion around it.

To provide correct operation, it is necessary to set respective proximity sensors sensitivity and delay (*read section 23 'Proximity sensors sensitivity'*).

### 15.4. Information

Information on weighing process is displayed in the grey workspace. The workspace can contain up to 4 data. If larger amount of data is selected, then only the first 4 are displayed.

Each parameter features two options:

- YES, information enabled (displayed in the workspace).
- NO, information disabled.

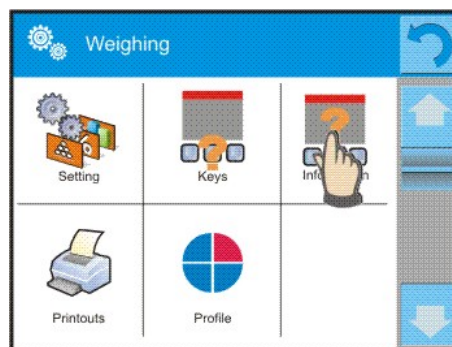

### 15.5. Weighing Printouts

Printouts menu comprises two separate sections:

- standard printouts,
- non-standard printouts.
  - **Standard printout** Standard printout comprises four internal sections containing different variables. YES entry - variable printout enabled, NO entry - variable printout disabled.

#### Procedure:

1. Press field with name of a template to be edited (Header – Weighing – Footer) and select variables to be printed.
2. If a printout is a non-standard one, create it.

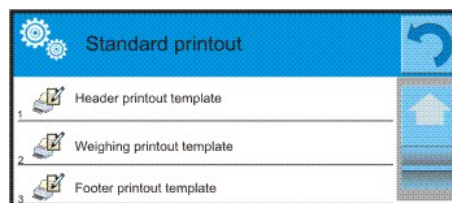



<b>HEADER</b>	<b>WEIGHING</b>	<b>FOOTER</b>
<ul style="list-style-type: none"> <li>- Dashes</li> <li>- Working mode</li> <li>- Date</li> <li>- Time</li> <li>- Balance type</li> <li>- Balance S/N</li> <li>- Operator</li> <li>- Level status</li> <li>- Customer</li> <li>- Warehouse</li> <li>- Product</li> <li>- Packaging</li> <li>- Universal variable 1 ... 5</li> <li>- Empty line</li> <li>- GLP report</li> <li>- Non-standard printout</li> </ul>	<ul style="list-style-type: none"> <li>- N (measurements quantity)</li> <li>- Date</li> <li>- Time</li> <li>- Level status</li> <li>- Customer</li> <li>- Warehouse</li> <li>- Product</li> <li>- Packaging</li> <li>- Universal variable 1 ... 5</li> <li>- Net</li> <li>- Tare</li> <li>- Gross</li> <li>- Current result</li> <li>- Additional unit</li> <li>- Mass</li> <li>- Non-standard printout</li> </ul>	<ul style="list-style-type: none"> <li>- Working mode</li> <li>- Date</li> <li>- Time</li> <li>- Balance type</li> <li>- Balance S/N</li> <li>- Operator</li> <li>- Level status</li> <li>- Customer</li> <li>- Warehouse</li> <li>- Product</li> <li>- Packaging</li> <li>- Universal variable 1 ... 5</li> <li>- Dashes</li> <li>- Empty line</li> <li>- GLP report</li> <li>- Signature</li> <li>- Non-standard printout</li> </ul>

### HOW TO OPERATE PRINTOUTS

1. In order to print WEIGHING section variables press PRINT button on moisture analyzer's panel, only variables with attribute YES can be printed (see the above list).

2. Variables with YES attribute present in the HEADER and FOOTER are printed **ONLY** upon pressing **PRINT HEADER** and **PRINT FOOTER** pictograms. The pictograms have to be added to the bottom bar of the display, as quick access buttons.  
(For detailed instruction on how to add quick access buttons to the bottom bar of the display refer to section 15.3 of this User Manual).

	
Print header data	Print footer data

**Caution:**

Measuring units for mass indication:

- Net – the main measuring unit (adjustment unit)
- Tare – the main measuring unit (adjustment unit)
- Gross – the main measuring unit (adjustment unit)
- Current result – currently displayed measuring unit
- Supplementary unit – supplementary measuring unit
- Mass – the main measuring unit (adjustment unit)

**Non-standard printout**

Non-standard printout may contain: TEXTS and VARIABLES (acquired from the software during printout). Each non-standard printout is a separate project, featuring specific name, by which it is identified, and saved to the database of printouts.

**Procedure:**

1. Press <Non-standard printout> entry.
2. Press < Add> button.
3. A window with Name/Code/Project data opens.
4. Set name and code of a printout.
5. Press <Project> button,
6. Printout edit box with an on-screen keyboard is displayed.
7. Use the keyboard to design printout template, the printout may contain texts and variables

**Caution:**

- It is possible to add a printout by importing configured texts from flash drives connected to moisture analyzer's USB port.
- Printout's name is ONLY a NAME, and it is not part of its content.
- For information on how to design a non-standard printout template read section 19.12 Printouts.

**15.6. Profiles**

Profiles function has been described in section 14 Profiles.



## 16. WEIGHING

Load the weighing pan. Upon displaying  $\blacktriangleleft$  marker on the left, you can read weighing result.

Record/printout of the measurement result is available on pressing <PRINT> key: Depending on the settings, stable and unstable measurement results are saved or printed (regardless of stability marker  $\blacktriangleleft$  absence). For unstable measurement result question mark <?> is printed next to the mass value.

### 16.1. Weighing Unit Selection

Change of weighing unit is carried out by pressing the weighing unit pictogram visible next to the value of measurement result. Upon pressing the weighing unit, list of available units is displayed. Select the unit you need, the software automatically recalculates indicated value.

Units list:

<i>unit</i>	<i>symbol</i>	<i>unit</i>	<i>symbol</i>
gram	[g]	Taele Hongkong	[tlh]
milligram	[mg]	Taele Singapore	[tls]
kilogram	[kg]	Taele Taiwan	[tlt]
carat	[ct]	Taele China	[tlc]
pound	[lb]	Momme	[mom]
ounce	[oz]	Grain	[gr]
ounce Troy	[ozt]	Newton	[N]
pennyweight	[dwt]	Tical	[ti]

### 16.2. Good Weighing Practice

To assure long-term operation and correct mass measurements, follow the rules presented below:

- Start the moisture analyzer with no load on the weighing pan (permissible value of load on the weighing pan at start is  $\pm 10\%$  of the maximum capacity).

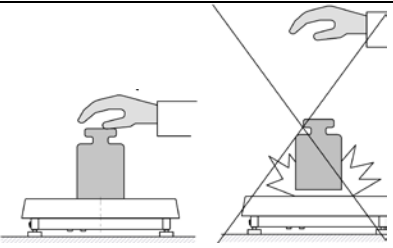
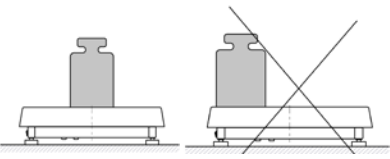
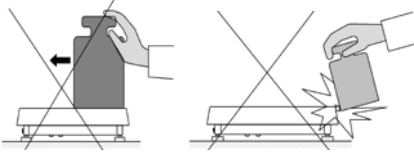
	
<p>Load the weighing pan steadily avoiding shocks</p>	<p>Place weighed loads centrally on the weighing pan</p>
	
<p>Avoid side loading, in particular side shocks</p>	

### 16.3. Leveling

The moisture analyzer is equipped with an AutoLEVEL System which enables monitoring of the moisture analyzer level. Level monitoring is performed uninterruptedly in the course of moisture analyzer operation. Level status is signalled with a respective pictogram, displayed in the upper right corner of the work panel. The system monitors moisture analyzer level state and on detecting any change the position of level marker is displayed on the screen and/or respective alarm is activated. Moisture analyzer level setting proceeds.

#### Leveling procedure:

- Press level status  pictogram located on the top of the display.
- Control panel of level function is displayed. Along with the level indicator, balance view is presented.

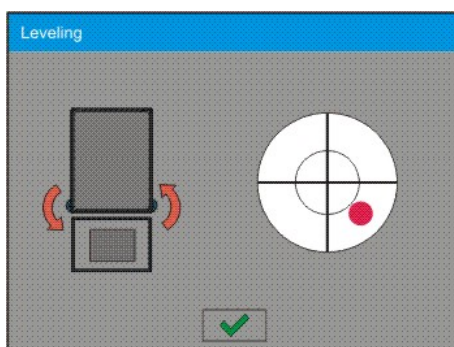

- Level the moisture analyzer by turning its feet left/right, follow the blinking pictograms,  – press to make level marker move towards the centre of the circle.
- When the marker takes central position, its colour turns from red to green – the moisture analyzer is correctly levelled.

#### Caution:

*The moisture analyzer is equipped with Automatic Level Control mechanism. For detailed information regarding the mechanism operation refer to section 23.8 of this user manual.*

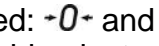

### 16.4. Zeroing

To zero mass indication press  key. Zero indication and the following pictograms are displayed: . Zeroing operation means determining new zero point, recognized by the weighing instrument as precise zero. The instrument can be zeroed only when the indication is stable.

#### Caution:

*Indication can be zeroed only within  $\pm 2\%$  range of maximum capacity. If the zeroed value is above  $\pm 2\%$  of the maximum capacity, then the software indicates a respective **Err2** error message.*



### 16.5. Taring

To determine net weight value, load the weighing pan with a packaging, wait for a stable indication and press  key. Zero indication and the following pictograms are displayed: **Net** and . Upon unloading of the weighing pan, the sum of tared masses with minus sign is displayed. You can assign tare value to a particular product stored in the database. In such case the assigned tare value is automatically acquired upon selection of the given product.

**Caution:**

It is impossible to tare negative values. When you try to tare negative values, the weighing instrument responds with an error message: **Err3**. In such a case, zero the indication and repeat taring procedure.

**Press to enter tare manually.****Procedure:**

- Press quick access key . The key is available regardless of the working mode you operate.
- An on-screen numeric keyboard is displayed.
- Enter tare value and press  button.
- Moisture analyzer returns to weighing mode. Tare value with „-“ sign is displayed.

**Deleting tare**

The tare value indicated on the display can be deleted by pressing key on the operation panel, or by using programmable <Deactivate tare> function button.



**Procedure 1** - upon taking the tared load off the weighing pan:

- press ZERO key,
- the <Net> marker gets deleted, new zero point is determined.

**Procedure 2** - with tared load on the weighing pan:

- press ZERO key,
- the <Net> marker gets deleted, new zero point is determined.
- when the tare value exceeds 2% of the maximum capacity, -Err- message is displayed in order to inform you about the fact that operation cannot be carried out.

**Procedure 3** - when the tared load is on the weighing pan or upon taking the tared load off the weighing pan:

- Press programmable key <Deactivate tare> ,
- the NET marker is deleted.
- the display indicates tare value.
- Press <Restore tare>  key to restore the last tare value.

**16.6. Additional Parameters for a Weighing Process**

Modification of weighing functions enables programming moisture analyzer operation.

**Procedure:**

1. Press grey workspace area.
2. The following submenus are displayed: Settings, Buttons, Information, Printouts, Profile.
3. Enter particular submenu and select the component that is to be modified

<Settings> - additional options related to weighing mode,

<Keys> - defining quick access buttons,

<Information> - supplementary data on weighing process displayed in an Info field,

<Printouts> - selecting printout type,

<Profile> - selecting profile that is to be active during moisture analyzer operation,

<SETTINGS> - weighing process related data such as:

– **Tare mode**

- **SINGLE:**

mass value saved to balance memory on single pressing of TARE key. Subsequent pressing of TARE key determines new tare value. Selecting product or packaging to

which tare value is assigned causes automatic deleting of previously assigned tare value.

- **CURRENT SUM**

total value of currently entered product and packaging tare values (result of selection of product and packaging from the database) with possibility to add tare value entered manually. When new tare value for a product or packaging is set again then tare value entered manually gets deactivated.

- **TOTAL SUM**

total value of all entered tare values.

- **AUTOTARE**

Means of operation:

Each first stable measurement result is tared. NET sign is displayed. Now you can determine net mass of weighed load. Upon unloading the weighing pan and autozeroing, tare value is automatically deleted

– **Automatic footer printout**

Available options:

MODE – None – manual footer printout,

Sum of measurements – footer is printed when mass value entered in <Threshold> parameter gets exceeded.

Measurements quantity – footer is printed when a pre-defined measurements quantity (a batch) set in parameter <Threshold> is carried out.

THRESHOLD – setting the threshold value determining footer printout.

For <Sum of measurements> parameter, threshold value is determined in measuring unit [g], for <Measurements quantity> parameter the unit is not determined, the provided value specifies carried out measurements quantity.

– **Printout/Enter mode**

- **PRINT/RELEASE BUTTON (manual operation)**

Never – printout disabled.

First stable – first stable measurement is recorded.

Each stable – all stable measurements are registered.

Each – printout of all measurements (stable and unstable), for verified moisture analyzer only stable measurements are printed out (as in <Each stable> setting).

- **AUTOMATIC MODE**

Never – printout disabled.

First stable - first stable measurement is registered; next stable measurement is registered after unloading the weighing pan, returning the indication to the value below set threshold value and loading the weighing pan again with next weight

Last stable - last stable measurement, registered prior unloading, is recorded. The record takes place upon unloading the weighing pan and returning the indication to the value below set threshold value.

- **THRESHOLD:**

Mass value obligatory for operation of automatic printout, set in grams.

## – Printout

Printout type related to a working mode. Printout is activated by pressing PRINT key on moisture analyzer panel.

Available options:

- **STANDARD PRINTOUT:**  
Enables declaring content of the following printouts: HEADER, WEIGHINGS and FOOTER.  
Select <YES> parameter for the components that are to be printed on pressing printout activating function key.
- **Non-standard printout**  
Enables selecting one of database-stored non-standard printouts form a list of <PRINTOUTS> menu, or designing a unique printout which is automatically added to the database.

### **Caution:**

*For detailed instruction refer to section 19.12 of this user manual.*

## – Air buoyancy compensation

Parameters allowing you to switch on the compensation and to enter weighed sample density data and air density data.

### **Caution: Function valid for weighing mode exclusively.**

For detailed information regarding the operation and settings refer to the previous section of this user manual.

## 16.7. Minimum Sample Weight

Weighing mode settings comprise <Minimum sample weight> function. In order to use the function it is necessary to enter data related to minimum sample weight determination methods and minimum sample weight values for a given method. The data must be entered to <Minimum sample weight> database. The database is empty in standard moisture analyzer version.

**Determining minimum sample weight and adding data to the : <Minimum sample weights> database can be carried out by an authorized “RADWAG” personnel exclusively.**

To use the minimum sample weight function, and need data on minimal sample weight to be entered to moisture analyzer menu, please contact the local representative of “RADWAG” company.

Using reference sample weights, the authorized RADWAG employee determines minimum sample weight for specified tare containers. This operation is carried out at the place of use and in accordance with requirements of the applied quality system. The obtained values are entered to moisture analyzer software: <Minimum sample weights> database.

For a particular method of minimum sample weight determination, it is possible to define few tare values along with values of minimum sample weights, expiry dates of the carried out measurements and entered data. The settings are not to be edited by a moisture analyzer operator.

<Minimum sample weight> function guarantees that the results of weighing operation are comprised within the set tolerance, in accordance with applied quality management system of particular company.

*Caution: Function valid for weighing mode exclusively.*

Available options:

- **METHOD**  
Option allowing you to select used quality standard. Press METHOD entry to open a window with a list of database-stored methods by means of which the minimum sample weights were determined. In order to add a new method enter <Databases /Minimum sample weights>.
- **MODE**  
**Block** – select to display pictograms informing you on status of weighed mass (weighed mass below/above minimum sample weight) and to disable accepting the measurement result if it is below the minimum sample weight limit.  
**Warn** – select to enable display of respective pictograms informing you about the measured mass (whether it is lower than the MSW value or higher than the MSW value). You can accept the measurement that is lower than the MSW value. Mind that on a printout it will be preceded by an asterisk (\*).

**Caution:**

For information on how to enter a method for minimum sample weight go to section 19.8 <Databases /Minimum sample weights> of this user manual. New minimum sample weight values can be entered by an authorized RADWAG personnel exclusively.

**Weighing with use of <MINIMUM SAMPLE WEIGHT> function.**

If in the course of weighing you want to find out whether a particular measurement value is higher than the MSW value, specified for a given weighing range, then <Minimum sample weight> function must be on. To turn the function on go to weighing mode settings.

**Procedure:**

1. Press grey workspace area.
2. The following submenus are displayed: Settings, Buttons, Information, Printouts, Profile.
3. Select <Settings> menu - additional weighing process options.
4. Enter <Minimum sample weight> parameter group.
5. Wait for Minimum sample weight window to open.
6. Press <Method> entry,

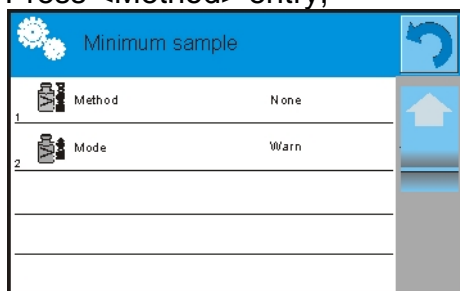

6. Window with a list of database-stored methods opens.
7. Select respective method.
8. Previous menu is displayed.
9. Press <Mode> parameter.
10. Settings box is displayed, select respective option:  
**Block** – select to enable display of respective pictograms informing you about the measured mass (whether it is lower than the MSW value or higher than the MSW value); with this option on, the program makes it impossible to accept the measurement that is lower than the MSW value.  
**Warn** – select to enable display of respective pictograms informing you about the measured mass (whether it is lower than the MSW value or higher than the MSW value).

value). You can accept the measurement that is lower than the MSW value. Mind that on a printout it will be preceded by an asterisk (\*).

11. Set the parameters and exit the menu.
12. Section presenting the weighing result comprises additional pictogram providing supplementary information. The pictogram changes in the course of weighing operation, it informs you on the weighed sample mass; the information is referred to the declared minimum sample weight value.

<p>The screen displays '0.000 g' in large black digits. Above the digits is a red downward-pointing arrow with the word 'Min' in white. Below the digits is a progress bar from 0% to 100%. The background is light blue with a scale icon in the top left. At the bottom, there are several small icons.</p>		<p>The screen displays '11.358 g' in large black digits. Above the digits is a green upward-pointing arrow with the word 'OK' in white. Below the digits is a progress bar from 0% to 100%. The background is light blue with a scale icon in the top left. At the bottom, there are several small icons.</p>
<p>Weight value lower than the MSW value specified for a particular tare range.</p>	<p>Weight value higher than the MSW value specified for a particular tare range.</p>	

### Pictograms providing MSW-related information:

	<p>Weight value lower than the specified MSW value.</p>
	<p>Weight value higher than or equal to the specified MSW value.</p>
	<p>Weight value lower than the specified MSW value. A pictogram with a clock informs on expiry of the minimum sample weight validity period (it is displayed two weeks before the determined expiry date).</p>
	<p>Weight value higher than the specified MSW value. A pictogram with a clock informs on expiry of the minimum sample weight validity period (it is displayed two weeks before the determined expiry date).</p>
	<p>The validity period of the minimum sample weight has expired. The minimum sample weight settings need to be modified. The minimum sample weight settings can be modified by an authorized RADWAG personnel exclusively.</p>

**Caution:** If more than one reference tare value is programmed (with corresponding minimum sample weight mass) then the indicated value automatically moves to a range corresponding to the weight of the tared container. At the same time the required minimum mass is changed.

## 16.8. Cooperation with Titrators

In order to provide correct cooperation with TITRATORS, go to settings of standard printout content and set <Mass value for a titrator> parameter to <Yes> entry. With this, other variables for the printout are turned off.

The screenshot shows a weighing scale interface. On the left, a 'Weighing printout template' menu lists several options:

Item	Value
MW-Method	No
Reference tare	No
Minimum sample	No
Minimum sample status	No
Mass value for a titrator	No
Non-standard printout	None

On the right, the weighing display shows '0.000 g' and a progress bar from 0% to 100%. Below the display, a 'Supplementary unit' section lists 'Tare' and 'Gross' as 0.000 g. A red circle highlights the 'Mass value for a titrator' option in the menu and a green indicator light in the top right of the display.

The pictogram informs on special format of mass printout, permissible by TITRATORS.



## 17. DRYING - GENERAL INFORMATION



**<Drying>** is a working mode that enables determining moisture content in a substance by drying the substance. When the process is started by the operator, the moisture analyzer verifies weight loss of dried sample. The moisture content is calculated automatically and displayed in real time. The result is updated continuously during the process. The process is finished automatically upon fulfilling operator's requirements.

### 17.1. Samples Preparation

This section contains detailed information on how to obtain optimum results of the drying process. There are hints for selection of appropriate drying parameters for various materials and substances.

#### 17.1.1. Moisture Content Measurement

The calculation is made on the basis of the loss of sample's mass during its heating (evaporation).

RADWAG moisture analyzer consists of two parts: precision balance and drying chamber. Compared to standard moisture content determining methods, the measurements with application of RADWAG moisture analyzer is much quicker and does not require additional mathematical calculations (a result of moisture content is previewed on an ongoing basis during product testing process)

Independently on moisture content determining method, the measurement accuracy is highly influenced by means of sample preparation and selection of testing parameters, such as:

- sample size,
- sample type,
- microwaves power,
- drying time.

In practice, the measurement accuracy is not as important as the speed of obtaining measurement result (control over technological process). Thus, heating a sample (e.g. with microwaves) carried out by a moisture analyzer, makes the measurement process very time efficient and short. Measurement speed can be additionally increased by appropriate adjusting moisture analyzer's parameters depending on tested substances. Optimum **microwave power** and **drying time** depend on sample type and size, and anticipated measuring accuracy. **Selection of drying parameters can only be carried out on basis of test measurements.**

#### 17.1.2. Sampling and Preparation

Sample features, its preparation and size are very important factors influencing the speed and accuracy of measurement process. Means of sampling and preparation are extremely important for repeatability of measurement results, as a sample should be a representative part of tested substance.

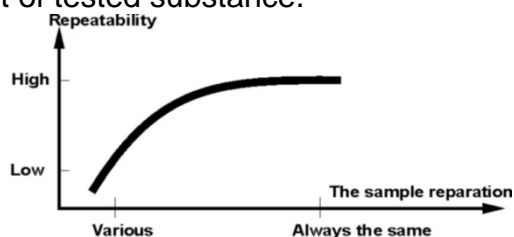

Final measurement result is vastly conditioned by precise and considered sample preparation. A sample used for analysis has to represent the total structure of tested material. Sampling process should determine: sampling means, sample disintegrating, particle size after disintegration, sample uniformity and other. The sampling process should be carried out as quickly as possible, so that a sample does not lose or absorb humidity from surrounding area. Applied sampling standards should match individual operator needs and requirements of tested material, its consistence and sample size.

### **Samples quantity**

Increasing number of tested samples also increases statistic measurement certainty. Number of samples depends on uniformity of tested material, its purity, accuracy of applied measuring method and anticipated accuracy of obtained results.

### **Mechanical fragmentation of the material to be measured**

Applied disintegrating method should be selected appropriately to tested material. Substances that are hard and brittle (crisp) can be disintegrated by cutting. Grinding such substances may cause their heating and thus humidity vaporization, resulting in unreliable measurement results. Unless a substance can be prepared for measurement otherwise than grinding, any possible moisture content loss should be calculated.

### **Grease in a form of paste or melting substances**

Such substance requires testing with use of a filter made of glass fibre, which considerably increases active evaporation surface by separating the substance between the fibre. Initial filter drying is necessary only in case of measurements which require very high accuracy.

### **Liquid substances**

In case of liquid substances it is proved to use a glass fibre filter to shorten measurement time. The filter causes separating tested liquid around the fibres, and increasing active evaporating surface. Initial filter drying is necessary only in case of measurements which require very high accuracy.

## **17.2. DRYING PARAMETERS SELECTION**

### **17.2.1. Selecting Optimum Sample Mass**

Sample mass influences the accuracy of measurement result and measurement time. Higher mass of a sample, causes higher amount of water (moisture content) which needs to evaporate, and therefore measurement time is also longer. Obtaining short measurement time is feasible in case of small sample mass, but sample mass cannot be too small, as it may negatively influence required measurement accuracy.

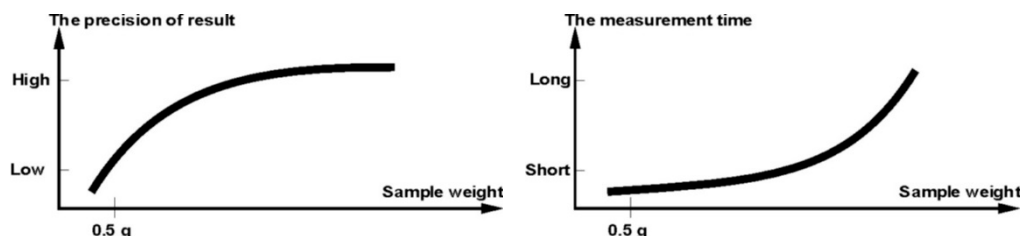

### **17.2.2. Influence of Sample Mass on Measurement Result Repeatability**

Sample mass considerably influences repeatability of measurement results obtained on a moisture analyzer.

Results are always burdened with uncertainty resulting from the sample and repeatability of the moisture analyzer.

### 17.2.3. Microwaves Power

The power significantly influences drying time. Its value depends on the type of material. Too low power causes partial evaporation of water (the sample is not dried completely). As a consequence, the measurement takes more time. Too high temperature causes material burning (overheating, chemical degradation).

When choosing the power:

- determine water content in a sample,
- determine the temperature of chemical degradation via experiments,
- compare moisture analyzer method result and the one obtained using traditional method.

### 17.2.4. Drying Profile Selection

Moisture analyzer software enables selecting one of four drying profiles:

- Standard
- Quick
- Mild
- Step

#### STANDARD profile

Standard profile is the most frequently used of all drying profiles. It enables accurate determining of moisture content in a dried sample.

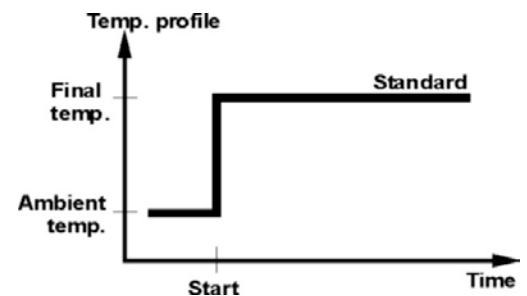

#### MILD profile

Mild profile is used in case of drying substances that are sensitive to rapid heat emitted by filaments operating at full power in the initial stage of drying process. This profile prevents from decomposing of substances sensitive to heat by mild temperature increase in set amount of time (time interval has to be selected by tests). Mild profile is recommended to drying samples of leather structure.

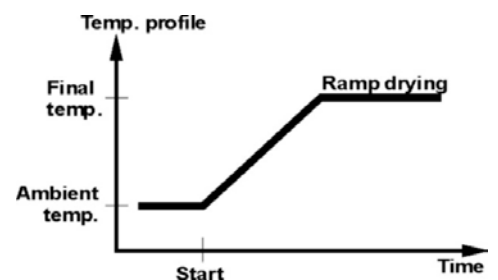

#### FAST profile

Fast profile is used in case of samples containing moisture content of several dozens percent. In the initial stage of the Fast profile, heating takes place at full power of the filaments, causing heating the drying chamber to increased temperature (maximum temperature value is higher by 30 % from set drying temperature). Overheating compensates heat loss during evaporation of significant moisture content in the test's initial stage.

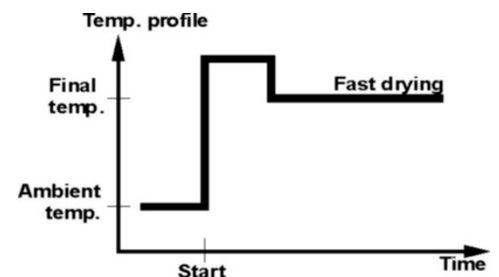

## STEP profile

Enables determining up to three steps with random drying temperature. Step profile is recommended for drying substances with moisture content over 15%. Temperature and heating time in each step have to be determined experimentally.

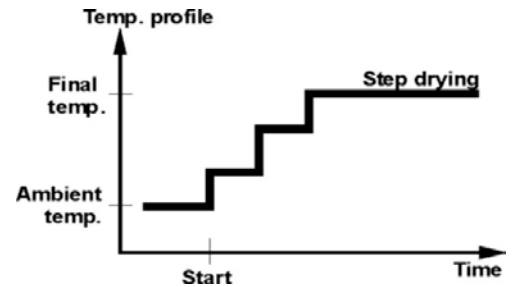

### 17.2.5. Drying Time Selection

Drying time is set by selecting one of available finish mode criteria. This means that a moisture analyzer must meet pre-set criterion (one of the requirements: mass over time, time) to automatically finish the drying profile.

The drying process can be finished after specified time, independently on loss in mass. This criterion is used for substances that may decompose during drying process, and their mass does not reach constant value.

The second criterion is the lack of loss in mass (less than 1 mg) in defined amount of time.

### Automatic finish mode (Auto switch off mode)

Moisture analyzer operator can choose between various types of finish modes:

- Automatic 1 (1mg/10s change).
- Automatic 2 (1mg/25s change).
- Automatic 3 (1mg/60s change).
- Automatic 4 (1mg/90s change).
- Automatic 5 (1mg/120s change).
- Time defined (max time: 99 hours 59 minutes).
- Manual (on pressing a function key).
- User defined 1 (set mass change ratio  $\Delta m$  0.1-9.9mg and time interval  $\Delta t$  max 2.55sek.)
- User defined 2 (set moisture content change ratio  $\Delta \%M$  over time 60s).
- Test (enables adjusting finish mode parameters to a tested sample)

### Automatic finish mode – user defined criterion (mass/time)

The operator determines the limit value for loss of mass and time in which the loss of mass must not exceed a pre-set value. As the moisture analyzer reaches the set criterion it automatically finishes the measurement (drying process).

### Automatic finish mode – user defined criterion (change of moisture content)

An operator determines limit loss of moisture content over 60s. As the moisture analyzer reaches the set criterion it automatically finishes the measurement (drying process).

### Manual finish mode



An operator ends drying process manually by pressing STOP button on moisture analyzer's display.

### Time defined finish mode

Drying process is finished after specified time, independently on measurement result.

## 18. DRYING PROCESS

### 18.1. Drying Profile Start-Up

Go to the home screen, press  pictogram located in the upper bar of the display. <Working modes> submenu containing list of working modes is displayed. Select <Drying> mode, the home screen is displayed automatically, wherein the top bar of the screen features  pictogram.

Info field provides the following information:

- Drying program,
- Product.

Upon selecting the drying profile, the following access buttons are displayed:

	<ol style="list-style-type: none"> <li>1. Setup – press to access moisture analyzer menu.</li> <li>2. Drying programs – press to access database of drying programs.</li> <li>3. Products database - press to access products database.</li> <li>4. Drying graph - press to display drying graph (active during drying process only).</li> <li>5. Drying program information.</li> <li>6. User manual.</li> <li>7. Drying process start.</li> </ol>
--	---













### 18.2. Drying Parameters Settings

Drying parameters are set in a way described further down this user manual.

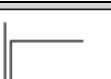
#### 18.2.1. Using Fields Visible on the Home Screen

The option enables quick setting of each drying parameter, with no need to enter menu options. An operator gets access to drying parameters on pressing an active field on the touch screen display.

There are three basic fields:

		 100 %  Auto 2  1 mg  25 s  %M  0:00:30
1	This field enables setting drying profile and parameters related to selected profile.	 100 %
2	This field enables setting finish mode criterion, and its parameters (depending on selected option).	 Auto 2  1 mg  25 s
3	Field enables setting type of data previewed on the display during drying process, and printed on a connected printer. It also enables setting printing time interval of moisture content value in dried product.	 %M  0:00:30

**Caution:**

**Option disabled if active drying profile is selected from database of drying programs.**

**DRYING PROFILE**

To enter profile selection and settings press dedicated soft button on the display.

Upon pressing the soft button, window for selecting profile is displayed. Select profile by pressing its name.

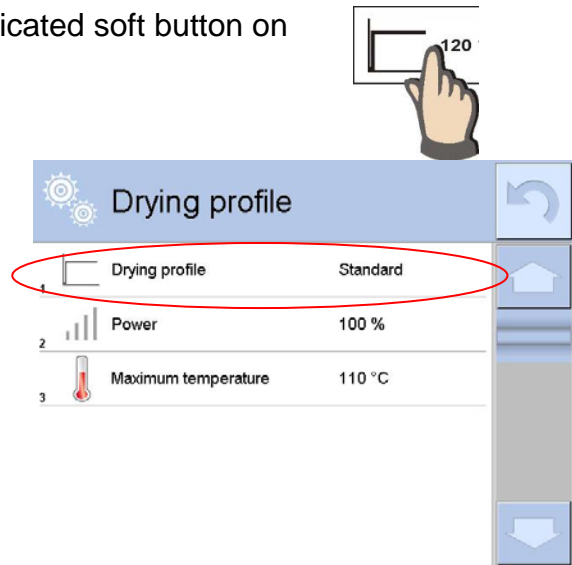

Window for selecting profile type is displayed.

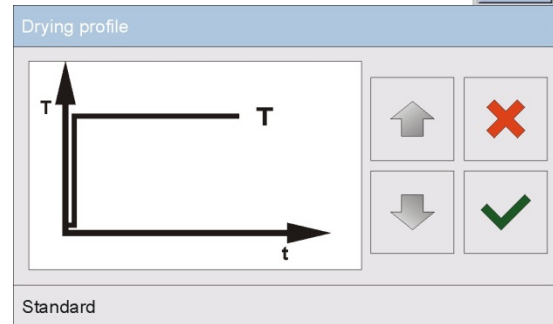

Use navigating arrow buttons to select required profile.

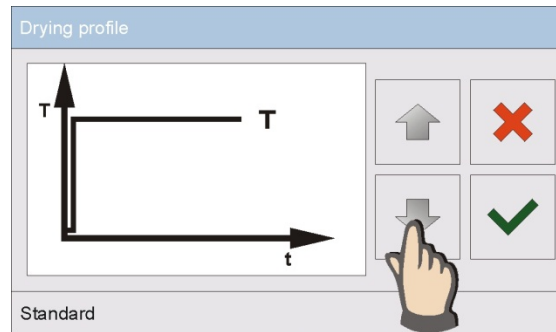

Upon selecting profile confirm the action.

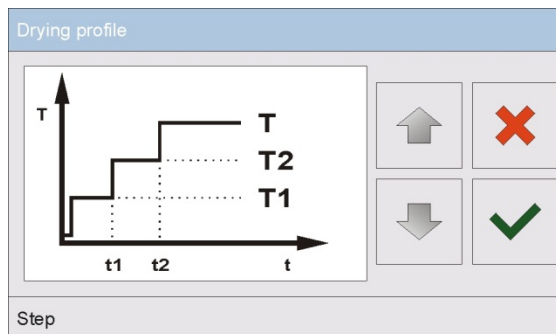

Previous window is displayed. Displayed data refer to selected profile.  
Set drying parameters to operator's needs by pressing a name of data to be edited.

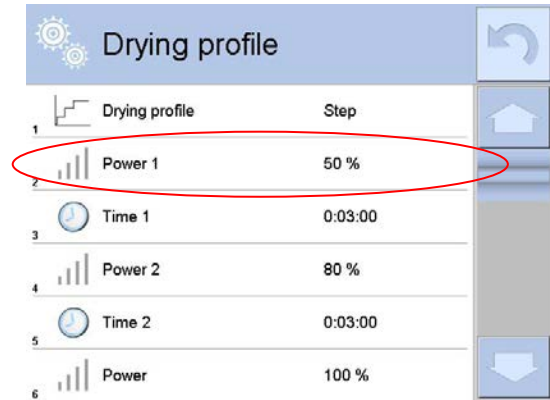

**Window for editing microwave power**

Enter required power using the on-screen numeric keyboard and confirm the action.

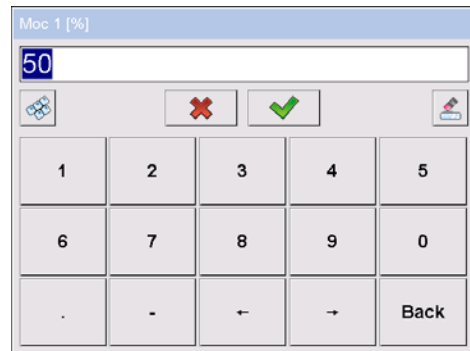

**Window for editing drying time**

Insert desired drying temperature value for particular thresholds using the on-screen numeric keyboard, and confirm the action.

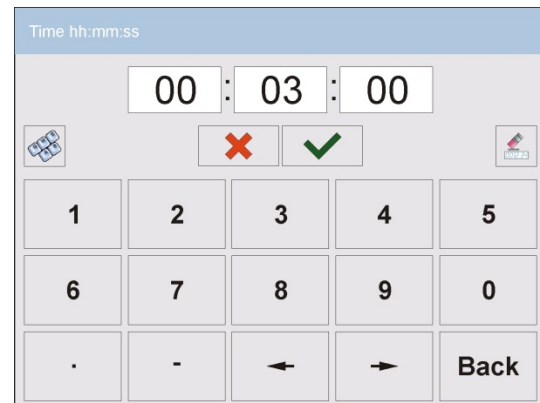

Upon setting the parameters return to Drying profile home screen. A pictogram on the home screen indicates data with selected drying profile and set temperature values.

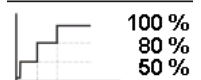

**Window for editing maximum temperature**

Enter maximum temperature that a sample can reach during drying using the on-screen numeric keyboard and confirm the action. The temperature has to be selected in a way preventing from damaging the sample during measurement, which may cause incorrect moisture content determination.

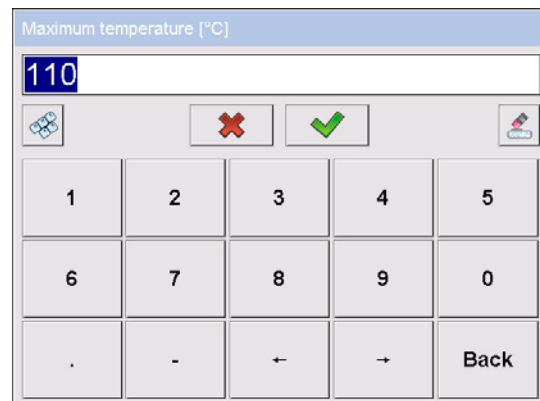

**Caution:**

*For the fast and step mode the drying time in overdrive temperature (step mode) or particular thresholds (fast mode) should be set. The time is counted from the moment of reaching the temperature for the particular threshold.*

## FINISH MODE

Select and set finish mode parameters by pressing dedicated soft button on moisture analyzer's display.

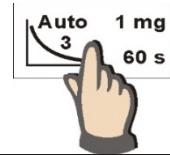

Upon pressing the soft button, window for selecting finish mode is displayed. Select finish mode by pressing its name.

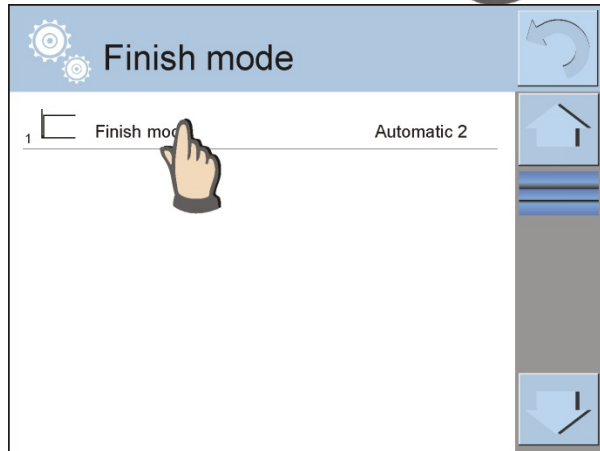

A window for selecting finish mode is displayed. Use navigating arrow buttons to select required finish mode.

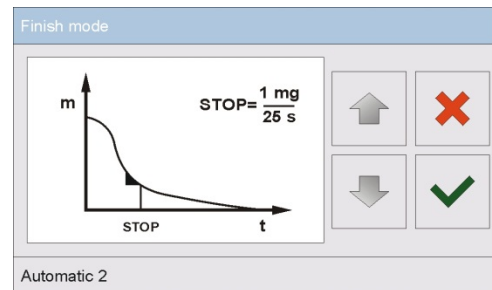

Upon selecting finish mode confirm the action.

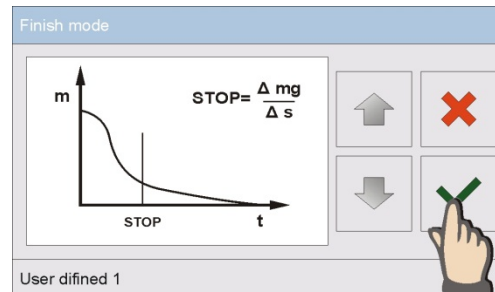

The previous window is displayed. Displayed data refer to selected finish mode.

Set parameters to operator needs by pressing a name of data to be edited.

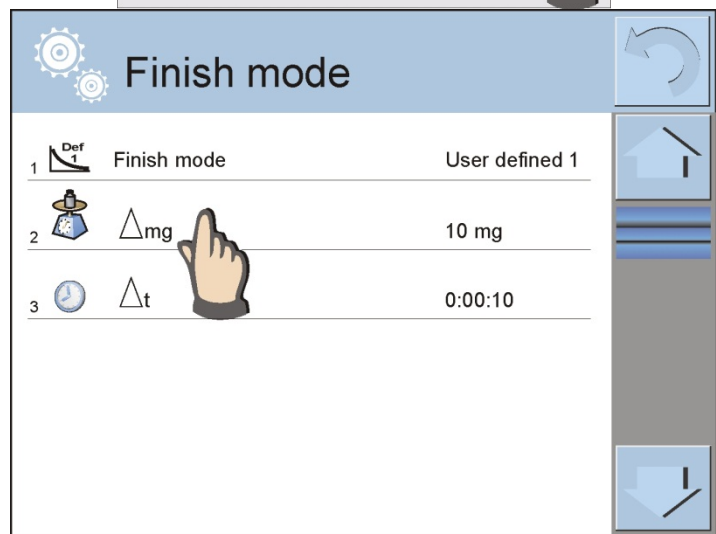



### Window for editing mass change

Enter mass value using the on-screen keyboard and confirm the action.



### Window for editing time interval

Enter time interval using the on-screen keyboard and confirm the action.



Upon setting the parameters return to Drying profile home screen. A pictogram on the home screen indicates data with selected finish mode settings.

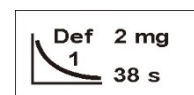

### PRINTOUT

Select and set measurement printout parameters by pressing dedicated soft button on moisture analyzer's display.

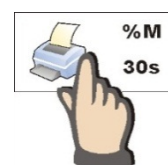

Upon pressing the soft button, window with printout settings is displayed. Press <Result> parameter to change the setting.

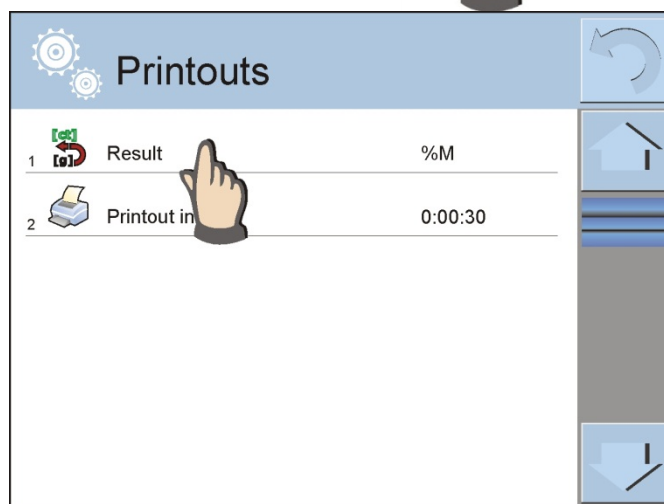

A window for selecting unit is displayed.  
Use navigating arrow buttons to select required unit.  
Settings: %M; %D; %R; m [g].

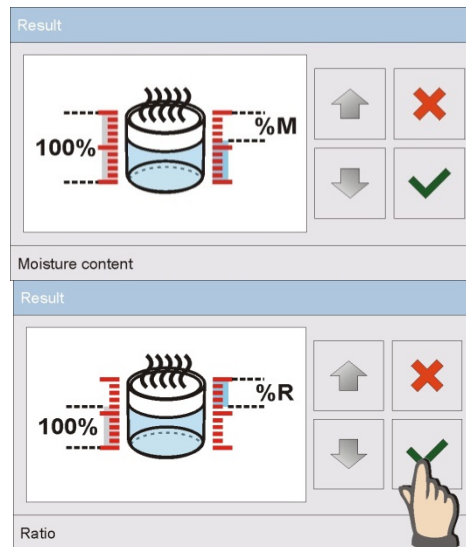

Upon selecting unit confirm the action.

### Window for editing time change

Enter time change value using the on-screen keyboard and confirm the action.

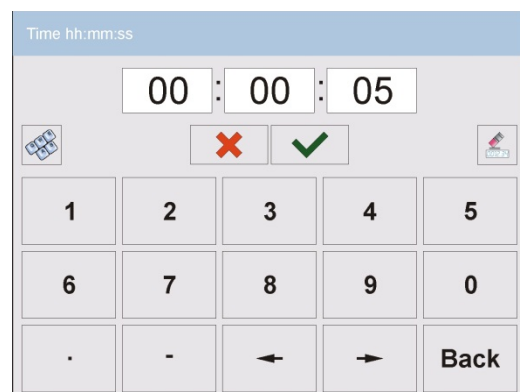

Upon setting the parameters return to Drying profile home screen. A pictogram on the home screen indicates data with selected printout settings.



### 18.2.2. Use of <Settings> Menu

After entering the moisture analyzer settings, the operator can define all drying parameters, and main data for printing completed measurements (data type, time interval between printing the following measuring data). The data is determined via single menu window.

#### Procedure:

1. Press grey workspace area.
2. The following submenus are displayed: Settings, Buttons, Information, Printouts, Profile.
3. Select <Settings> menu.
4. Functions related to checkweighing are displayed.
  - **Drying profile** [means of sample heating],
  - **Finish mode** [drying process finish criteria],
  - **Result** [moisture content measuring unit, active on drying process start ],
  - **Printout interval** [time intervals in which measurement data is printed],
  - **Start mass control** [enabled / disabled meeting a requirement of determined start mass of a sample, with declared tolerance of this mass value (setting mass value and its tolerance is carried out in products database)],
  - **Autotare** [enabled/disabled automatic taring of disposable pan mass during drying process start-up],
  - **Print measurements** [printing indirect measurement result of moisture content determination with time interval set in <Measurement time> parameter].

Means of setting each parameter is the same as in case of the previous menu option. The only difference refers to possibility of declaring parameter of controlling start mass for a sample.

This parameter determines use of a sample with specific mass to test its moisture content.

**CONTROL OF START MASS** enables setting one of three options:  
**None** – option disabled, mass of a sample prepared for drying is not controlled by the software.

**Optional** – option enabled, the display shows a bar graph demonstrating graphic visualization of sample mass in relation to mass value saved in the database of products. It is a sample mass and its tolerance limits set in the software. Before applying this option, add a product in the database, including data on sample mass and its checkweighing limits. On enabling this option, the moisture analyzer's software displays commands on placing a sample with determined mass on the drying pan. However, if an operator decides otherwise, then a moisture analyzer starts drying process even if sample mass exceeds determined threshold limits for a tested sample mass.

**Mandatory** – option enabled, the display shows a bar graph demonstrating graphic visualization of sample mass in relation to mass value saved in the database of products. It is a sample mass and its tolerance limits set in the software. Before applying this option, add a product in the database, including data on sample mass and its checkweighing limits. On enabling this option, the moisture analyzer's software displays commands on placing a sample with determined mass on the drying pan. Unless the sample mass is within set threshold limits, the software does not allow to start drying process.

There are two ways of using this option:

1. For any optional product press quick access button:

 **Checkweighing thresholds**> or  **Target value**>.

2. In combination with specific product in  **Products database**>.

In the 1st case, the target value, checkweighing thresholds and percent tolerance of mass has to be set using quick access buttons.

In the 2nd case, the value of mass and tolerance fields have to be specified in their corresponding fields of the <Products database>.

## **TOLERANCE THRESHOLDS OF SAMPLE MASS - PROCEDURE:**

**MIN** and **MAX** thresholds: the software accepts mass of an ingredient as correct if it is within set MIN and MAX thresholds (data acquired from database of products).

**TOLERANCE**: the software accepts mass of an ingredient as correct if it is within set percent tolerance of total ingredient's mass ( $\pm\%$ ) - (data acquired from database of products).

Before starting drying process, an operator has to declare parameters of a sample which is loaded on the drying pan: MIN and MAX, target mass and percent tolerance of sample mass. On setting the above criteria the software allows for beginning the drying process.

1. Defining the value of Min/Max thresholds is carried out in the Database of Products

during editing a Product or by using  **Checkweighing thresholds**> quick access button.

### **Procedure:**

- Press grey workspace, next select <Buttons> parameter.

- Assign <Checkweighing Thresholds> parameter to one of the quick access buttons.
- Return to drying.
- Press  <Checkweighing thresholds> entry and enter Min and Max threshold values. Return to drying profile.
- After displaying <PREPARE SAMPLE> command, the display, below the measurement result, indicates a bar graph, which using colours shows current mass on the drying pan.
- yellow: mass value lower than Min threshold value.
- green: mass value higher than Min threshold value and lower than Max threshold value,
- red: mass value higher than Max threshold value.

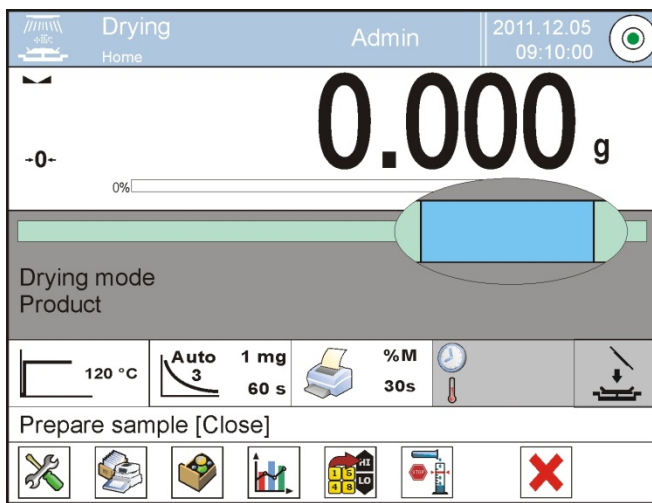

2. In order to define target value press quick access button,  <Target Value>.

### Procedure:

- Press grey workspace, next select <Buttons> parameter.
- Assign <Target value> parameter to one of the quick access buttons.
- Return to drying.
- Press  <Target value> entry and enter mass to be obtained.
- Enter +/- tolerance of the target mass (range: 0 – 100%).
- Bar graph is displayed. It provides the following information:
  - current mass (colour visualisation),
  - target mass value (black marker).

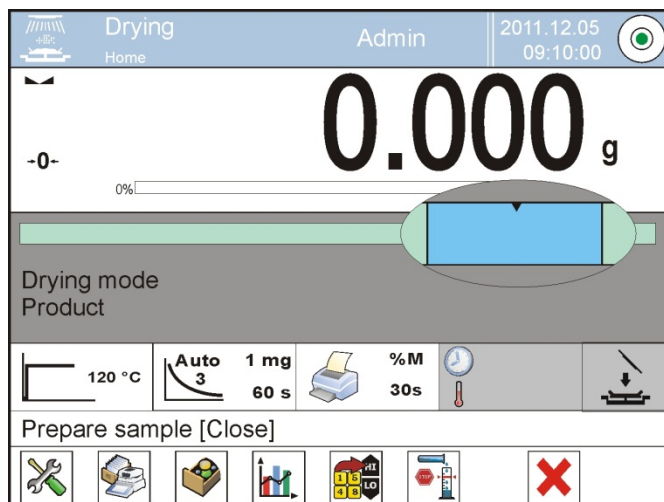

### Caution:

The checkweighing thresholds and target mass options may function simultaneously during drying process. In such case, the tolerance field is realized by Min and Max thresholds, and the bar graph indicates target mass marker.

On entering the database and selecting a product, which has the target mass value and Min & Max thresholds assigned, the software, while controlling the start mass, will first consider the Min and Max thresholds. The values of Min and Max thresholds can be changed before drying process using quick access buttons displayed in the bottom bar. New values accepted are instantaneous, and they are not saved in the product database.

### 18.2.3. Using Database of Drying Programs

Drying procedure can be carried out with use of a program saved in the <Database of drying programs>.

#### Adding program to Drying Programs Database

Database of drying programs contains saved drying procedures, which can be triggered before drying a sample. Adding procedure is intuitive and uncomplicated. Operator has to follow commands displayed on moisture analyzer's screen.

#### Procedure:

- Enter <  Databases> submenu, press <  Drying programs database> entry.
- Press <  Add> button to add a new program.

A new record is automatically added to the database, it is opened in an editing mode. Enter respective data regarding new program.

List of parameters defined for a program:

1. **Name:** press to enter program name.
2. **Code:** press to enter program code.
3. **Drying profile:** press to open a window with drying profile. Select respective profile and enter required data (drying power, time, maximum temperature of a sample).
4. **Finish mode:** press to open a window with finish mode. Select respective finish mode and enter required data (mass, time).
5. **Result** press to open a window with result unit. Select respective unit.

6. **Printout interval:** press to open a window with an on-screen numeric keyboard. Enter time interval between subsequent printouts during drying process.
  7. **Start mass control:** press to open a window with list of options, select one: **None, Optional, Mandatory.** Program data is displayed.
  8. **Equipment related to a sample:** Press to open a window with an on-screen keyboard and enter required equipment, e.g. a glass fibre filter.
  9. **Sample preparation:** press to open a window with an on-screen keyboard and enter the description regarding sampling, sample preparation and distribution on the weighing pan.
  10. **Recommended sample size:** press to open a window with an on-screen keyboard and enter recommended sample size determined experimentally.
- Upon entering program-related data, return to the home screen.

### 18.3. Drying Profile Printouts

Printouts option enables determining standard and non-standard printouts.

- **Standard printout**

Standard printout comprises three internal sections containing different variables. Variable settings: YES – print; NO – do not print.

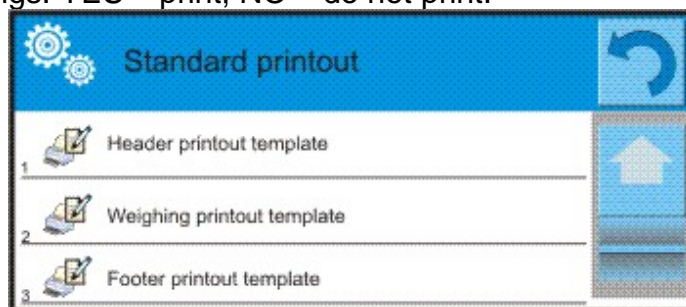

**Procedure:**

1. Press entry with name of a template to be edited (Header – Weighing – Footer) and select variables to be printed.
2. If a printout is a non-standard one, create it.

Drying report is a result of drying process. Report contains all printout data for header, weighing and footer. Each report printed during drying process and saved to the reports database has the format specified by an operator.

**Caution:** In order to specify which measurement data is to be printed on a report it is necessary to modify settings for <Weighing printout template> parameter. To enable particular measurement data printout, set it to <YES> entry for it.

Reports content:

<u>HEADER</u>	<u>WEIGHING</u>	<u>FOOTER</u>
– Dashes	– Dashes	– Dashes
– Working mode	– Date and time	– Working mode
– Start date	– Drying time	– Status
– Start time	– Product	– End date
– Balance type	– Current result	– End time
– Balance S/N	– Drying time and result	– Drying time
– Operator	– Net	– Balance type
– Product	– Tare	– Balance S/N
– Drying program	– Gross	– Operator
– Drying profile	– Additional unit	– Product
– Drying profile parameters	– Mass	– Universal variable 1 ... 5

<ul style="list-style-type: none"> <li>- Finish mode</li> <li>- Finish mode parameters</li> <li>- Unit</li> <li>- Printout interval</li> <li>- Universal variable 1 ... 5</li> <li>- Start mass</li> <li>- Empty line</li> <li>- GLP report</li> <li>- Non-standard printout</li> </ul>	<ul style="list-style-type: none"> <li>- Set temperature</li> <li>- Current temperature</li> <li>- Empty line</li> <li>- Non-standard printout</li> </ul>	<ul style="list-style-type: none"> <li>- End mass</li> <li>- Current result</li> <li>- Dashes</li> <li>- Empty line</li> <li>- GLP report</li> <li>- Signature</li> <li>- Non-standard printout</li> </ul>
---	---	--



## 18.4. Performed Drying Process Report

Upon completed drying process a report is generated. The report is saved to <**Drying process reports**> database. Report file name contains date and time of particular process performance.

### Report example:

```
-----
Start date      2012.06.25
Start time     14:41:55
Operator       Admin
Product        Tea
Drying program
Drying profile Standard
Finish mode    Automatic 3
Start mass     ? 0.386 g
0:00:30       1.295 %M
0:01:00       0.777 %M
.
.
0:06:00       1.295 %M
-----
```

```
-----
Status         Completed
End date       2012.06.25
Time date     14:48:05
Drying time   0:06:10
End mass      0.381 g
Current result 1.295 %M
-----
```

Signature .....

## 18.5. Drying Process Performance

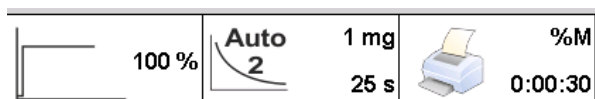

The bottom part of the display features pictograms with drying process settings.



If the parameters are incorrect, modify them to match the drying parameters of a sample that is to be dried.

For detailed information on how to determine the parameters read previous section of this user manual.

In order to use a drying program saved to the database:

- Enter  <Databases> and press  <Drying programs database> entry.
- Select drying program by pressing its name. The home screen is displayed. Name of selected program is displayed in the workspace. Parameters set for selected program are displayed in the fields containing drying parameters.
- Upon selecting a program, drying parameters settings cannot be changed. Drying parameters can only be changed if no drying program is enabled.
- An additional option is displaying (in an enabled drying program) descriptions on additional equipment needed for correct carrying out the drying process, sample preparation and recommended sample size.  
To use this option press <Sample description> quick access button. Upon pressing the button, a window with descriptions entered in the drying program is displayed.





Sample description

**Equipment related to a sample:**  
Aluminum disposable pan

**Sample preparation:**  
Spread a sample evenly on the whole surface of the drying pan.

**Recommended sample size:**  
~2.5 g

**Caution:**

The option is available only upon selecting program from the <Drying programs database>.

If the parameters are correct, the drying process can be started.



Press button to start the drying process.

Moisture analyzer displays prompts facilitating operation of the device. Follow the displayed prompts. This ensures proper preparation of sample for drying and carrying out the process.

[ Prepare pan [Accept]

A command to prepare the weighing pan is displayed.  
Place the filter on the cross-shaped holder.

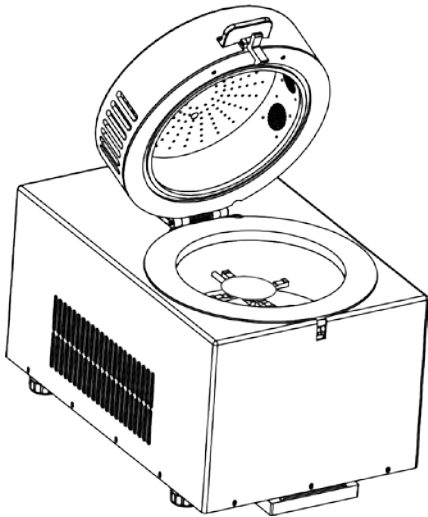

Weighing pan mass is displayed. It is recommended to close the drying chamber in order to provide stable ambient conditions while taring.

To do that, press  button to tare the weighing pan and save the measurement to the moisture analyzer's memory. Mass indication is ZEROED and the next prompt is displayed.

Prepare pan [Accept]

**CAUTION:**

If AUTOTARE option is enabled remember to place disposable weighing pan on the cross-shaped holder prior to the drying process. Next, press  button. Weighing pan is automatically tared and <Prepare sample> message is displayed.

If <START MASS CONTROL> option is enabled, at this moment the display activates a bar graph indicating current sample mass in relation to saved Min and Max limits for sample's mass.

Load the weighing pan with the sample. Select sample's mass according to previously carried out tests and characteristics of tested substance.

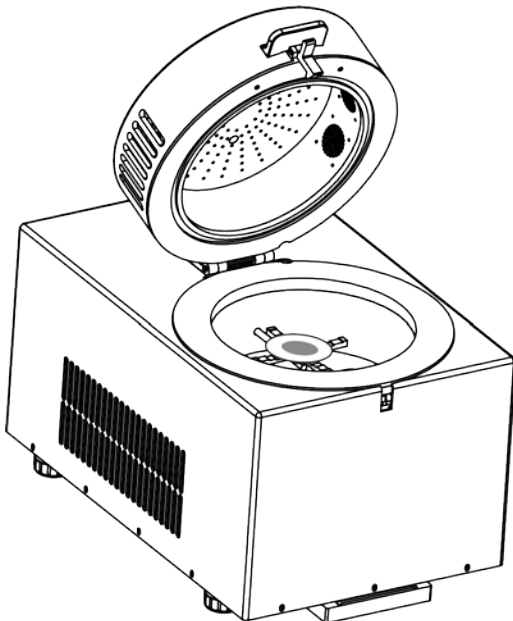

Upon result stabilization (respective pictogram displayed) close the drying chamber.

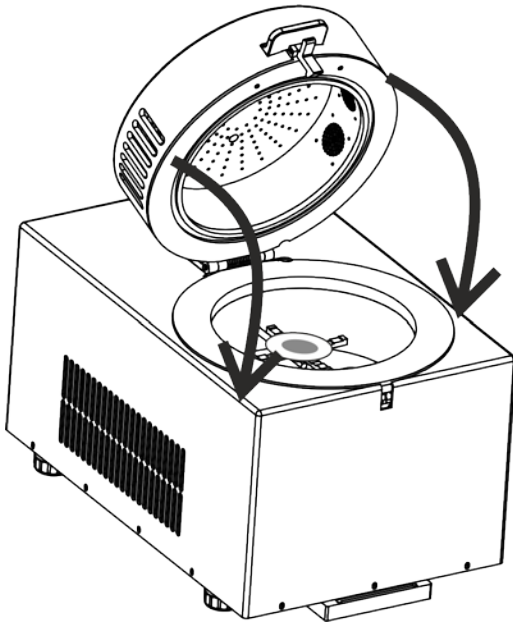

The drying process is started automatically. The moisture analyzer starts drying process according to pre-set parameters and the display indicates data on carried out process. During the drying process the moisture analyzer carries out all necessary mass measurements and calculations resulting from mass change, and sends a header to a specific communication port (compatible with settings of printout options).

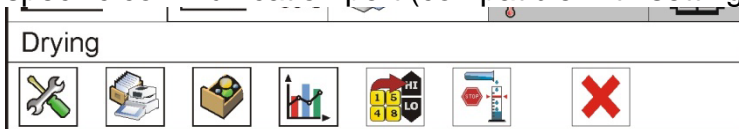

Current drying results and information on the process is displayed during drying (drying time, drying chamber temperature, etc.).

During drying measurements are automatically sent to the communication port (according to set printout parameters).

Moisture content unit can be changed during the process. To do that, press unit field. List of available units is displayed. Select respective unit. Upon selecting the unit, the software automatically calculates the indication and displays it on the screen.

The process can be aborted at any moment by pressing STOP button.

Upon drying process completion, summary of the test is displayed, final moisture content result is held.

Printout footer is sent to the communication port (according to set printout parameters).

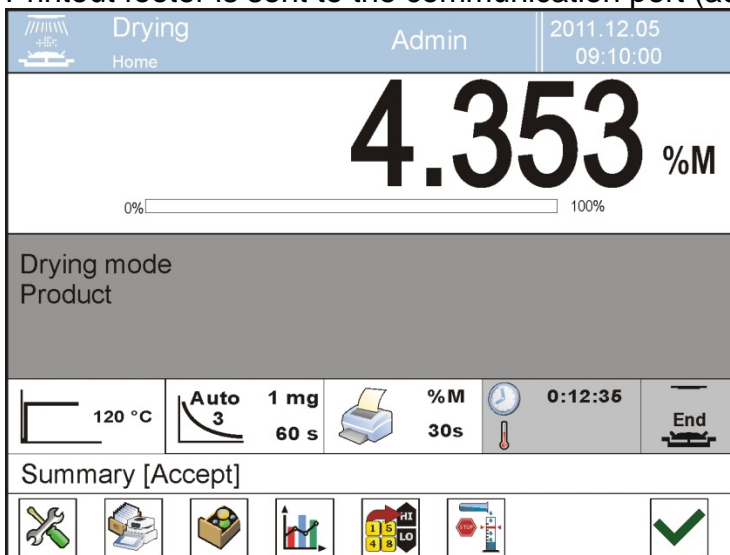



Press  button to finish the process. The home screen is displayed. Upon removing the dried sample from the drying chamber you can proceed to next measurement.

Remember that immediate starting of another drying process may result in distortion of moisture reading caused by evaporation of sample moisture if placed in a hot drying chamber before starting the drying process. Therefore a break is recommended between measurements to cool the drying chamber.

## 18.6. Drying Process Graph

The operator can preview drying process during the measurement or upon entering <Drying reports>.

### Graph preview during drying process



Press  Graph> button to display drying graph during the process.

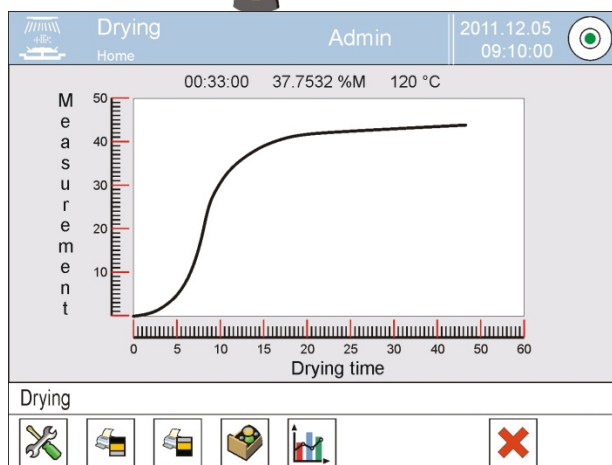



Drying graph containing data regarding the process is displayed. The graph is created in real time. This enables monitoring the process in actual time. To monitor the graph for various units, determine humidity unit prior to displaying the graph. Next, enter the graph.

Press  Graph> button to return to the home screen.

### Graph preview in the drying reports database

#### Procedure:



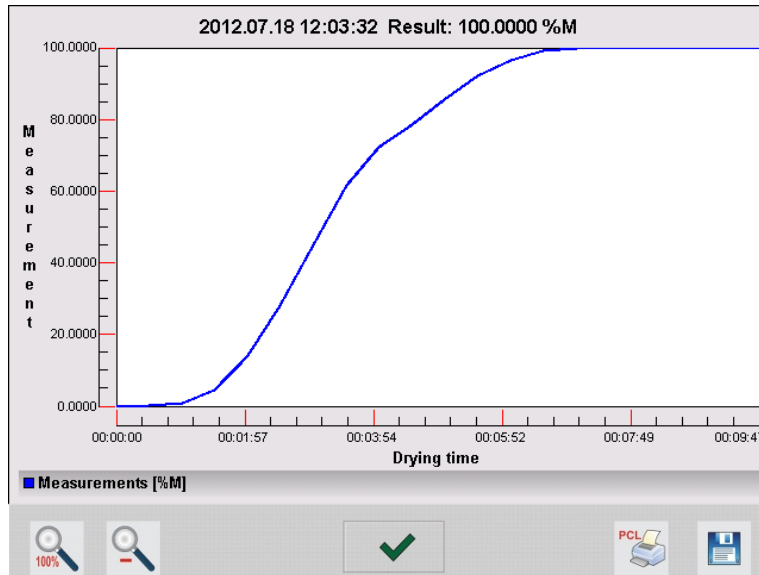

- Enter  Databases> submenu.
- Press  Drying reports> entry.
- Select report regarding given process by pressing its name (the name consists of date and time of drying process).
- Press  Graph> button.

The software generates and displays drying graph in the coordinate system of moisture content unit/measurement for carried out moisture content determination.

An exemplary graph:



Bottom bar tools:

	Press to display complete graph.
	Press to zoom out the screen content.
	Press to go back to the previous window.
	Press to print the graph using PCL printer.
	Press to save the graph as *.bmp file to USB flash drive connected to USB port.

## 19. DATABASES

Moisture analyzer software features the following databases <  >:

 PRODUCTS	 WEIGHINGS	 CUSTOMERS
 DRYING PROGRAMS	 DRYING REPORTS	 DRYING REPORTS STATISTICS
 MINIMUM SAMPLE WEIGHT	 AMBIENT CONDITIONS	 PACKAGING
 WAREHOUSES	 PRINTOUTS	 UNIVERSAL VARIABLES
 MANAGE THE DATABASE		

### 19.1. Database Connected Operations

Databases can be operated only by an authorized personnel.

Procedure:

- Press and hold respective database pictogram.
- Database menu is displayed.
- Select one of the available entries (entries set is conditioned by a database).



Entries:



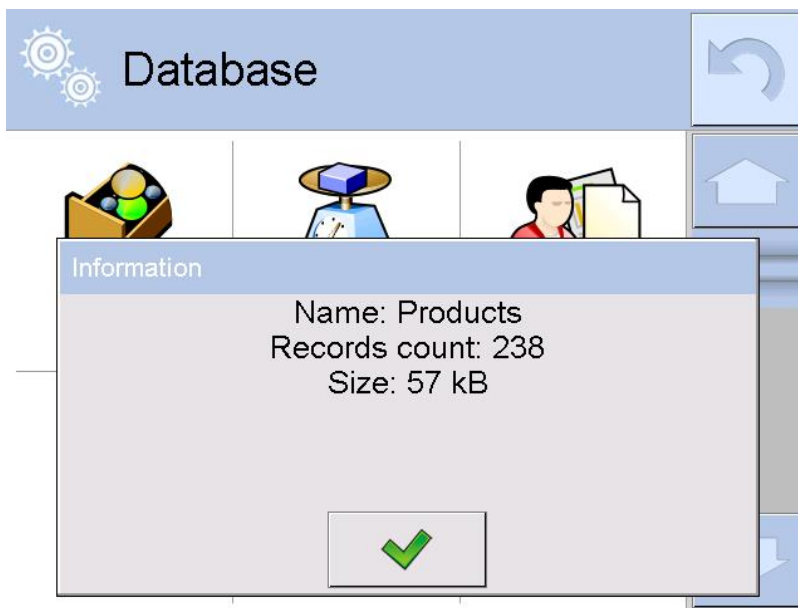



- OPEN – select to enter a database (alternative method for database entering: a single click on given database field).
- IMPORT – select to import data from a USB flash drive. Plug the USB flash drive to a USB port, upon its detection a window with a list of saved files is displayed. Select file with data to be imported. The copying starts automatically. Upon completion of the process message: <Completed> is displayed. Confirm completion.
- EXPORT - select to export data from selected database to a USB flash drive. Plug the USB flash drive to a USB port, upon its detection the software automatically starts a copying process. Upon completion of the copying process a window with both, a file name to which data has been saved and message: <Completed> is displayed. Confirm completion.
- INFORMATION – select to display information about database content (see the picture below).



Press  button to return to the previous window.

- CANCEL – select to return to the home screen.

List of typical database operations:

1. Adding entry to a database <  >.
2. Searching for a record in a database by name <  >.
3. Searching for a record in a database by code <  >.
4. Searching for a record in a database by date <  >.
5. Exporting database content to a USB flash drive via USB port <  >.
6. Printing data on a specific record in a database <  >.



The above processes are carried out by pressing dedicated buttons located on the top of the display. Follow the displayed commands.



## 19.2. Products

Product database stores names of all products that can be weighed or dried.

### Procedure:

- Enter  **Databases**> submenu, and press <Products> entry.
- Press  Add> button to add a new product to the database.
- Select already existing product.

List of parameters defined for a product:



1. Name
2. Description
3. Code [product code]
4. EAN code
5. Mass [nominal value of product mass]
6. Min [minimum start mass of a sample, that is recognized by the software as correct if option <START MASS CONTROL – LO> is enabled]
7. Max [maximum start mass of a sample, that is recognized by the software as correct if option <START MASS CONTROL – HI> is enabled]
8. Tolerance [% value calculated in relation to mass (5), denoting measuring area in which the measurement is recognized as correct. Enabled if option <START MASS CONTROL> is active]
9. Tare [product's tare value, set automatically on selecting a product from the database]
10. Price [unit price of a product]
11. Density [product's density, used for compensating air buoyancy, as sample density] - [g/cm<sup>3</sup>]
12. Shelf-life time in days
13. Date [set product's date (constant)]
14. VAT [VAT value related to a product]
15. Ingredients [Editing field for inserting names of ingredients used for preparing a product, e.g. if a product is a mixture, or if a product requires additional description of its features or application]
16. Printout [printing a template assigned to a product]

## 19.3. Weighing Records

Each weighing record sent from a moisture analyzer to a printer or a computer is saved to the weighing database.

You can preview data of particular weighings.

### Procedure:

- Enter  **Databases**> submenu.
- Enter  **Weighing records**> database and press respective record.

List of parameters for a weighing record saved to the database:

1. Measurement date





2. Measurement result
3. Tare value
4. Stable/unstable measurement making
5. Product name
6. Operator
7. Customer, customer name
8. Working mode name
9. Warehouse, source warehouse name.
10. Packaging, name of tare applied during product weighing.
11. Result control, information regarding range within which the weighed product is placed:
  - MIN – below LOW threshold (possible only if <Result control> is set to <NO> entry)
  - OK – within min and max threshold
  - MAX – above HIGH threshold (possible only if <Result control> is set to <NO> entry)
12. Weighing platform no., field denoting number of a weighing instrument by means of which a measurement was carried out,
13. Level status, information on level status maintained during the measurement,
14. Ambient conditions alerts, information regarding stability of temperature and humidity during the measurement.

#### 19.4. Customers

Customers database contains name of Customers for whom the measurements are carried out.

##### Procedure:

- Enter  Databases> submenu and press <Customers> entry.
- Press <  Add> button.
- Select already existing customer



List of parameters defined for a customer:

1. Customer name
2. Customer code [internal code identifying a customer]
3. TIN
4. Address
5. Postal code
6. City
7. Discount
8. Printout [type of printout, customer-related label]

#### 19.5. Drying Programs

Drying programs database provides parameters used for drying process.

##### Procedure:

- Enter  Databases> submenu and press <  Drying programs> entry.
- Press <  Add> button to add a new program.
- If program already exists in the database, press the filed with its name to edit it.

List of parameters defined for a drying program:



1. Name
2. Code
3. Drying profile
4. Finish mode
5. Result
6. Printout interval
7. Start mass control
8. Equipment related to a sample
9. Sample preparation
10. Recommended sample size

Parameters 8 to 10 inform on additional requirements needed to dry a product (e.g. using a filter made of glass fibre, using specific sample mass or means of preparing a sample for drying). The descriptions are enabled on pressing <Sample description> quick access button and enabling one of available drying programs.

### 19.6. Drying Reports

Drying reports provide information about carried out drying processes. Each report can be previewed, searched by date or exported and printed out.

#### Procedure:

- Enter  <Databases> submenu and press  <Drying reports> entry.
- Select report, if not visible, scroll the list using navigation buttons.
- Report is named by date and time;  
e.g. 2012.03.12 11:12:15.



#### CAUTION:

*It is possible to use 'search report' option.*

List of drying reports data:

- |                          |   |
|--------------------------|---|
| 1. Start date            |   |
| 2. End date              |   |
| 3. Drying time           | [drying time]   |
| 4. Status                | [data on drying process]  |
| 5. Start mass            | [initial mass of a sample]  |
| 6. End mass              | [final mass of a sample]  |
| 7. Result                | [final drying result]   |
| 8. Measurements          | [subsequent measurements saved during the drying process]           |
| 9. Operator              | [name of an operator carrying out drying process]                   |
| 10. Product              | [product name]  |
| 11. Drying program       | [name of a drying program used for carrying out the drying process] |
| 12. Customer             | [customer name]   |
| 13. Warehouse            | [source warehouse name]   |
| 14. Drying process graph | [a graph demonstrating progress of a drying process]                |

**Procedure:**



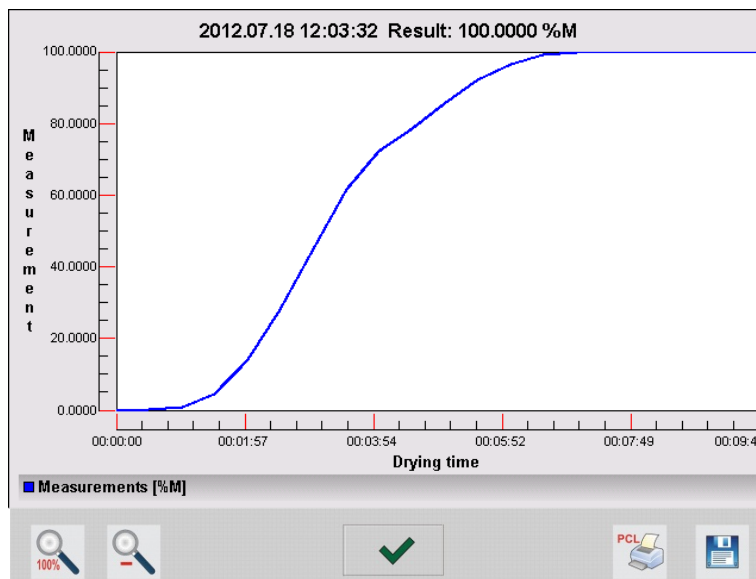

- Enter  Databases> submenu.
- Press  Drying reports> entry.
- Select report regarding given process by pressing its name (the name consists of date and time of drying process).
- Press  Graph> button.

The software generates and displays drying graph in the coordinate system of moisture content unit/measurement for carried out moisture content determination.

An exemplary graph:





Bottom bar tools:

	Press to display complete graph.
	Press to zoom out the screen content.
	Press to go back to the previous window.
	Press to print the graph using PCL printer.
	Press to save the graph as *.bmp file to USB flash drive connected to USB port.



**19.7. Drying Reports Statistics**

The menu option enables previewing history of completed drying processes of a specific product. Processes available for each product from the database: previewing reports for each of drying processes, generating graphs with obtained humidity content for all tested samples of a product, printing and exporting data on completed drying processes.

**Procedure:**

- Enter < Databases> submenu and press < Drying reports statistics> entry.
- Select product, for which history of tests has to be generated.
- Determine searching criteria (start and end date).
- Display list of drying reports fulfilling searching criteria (product, completion date): <Drying reports>.
- Generate a graph presenting the course of selected drying processes <Measurements graphs>.

**To generate measurement graphs:**



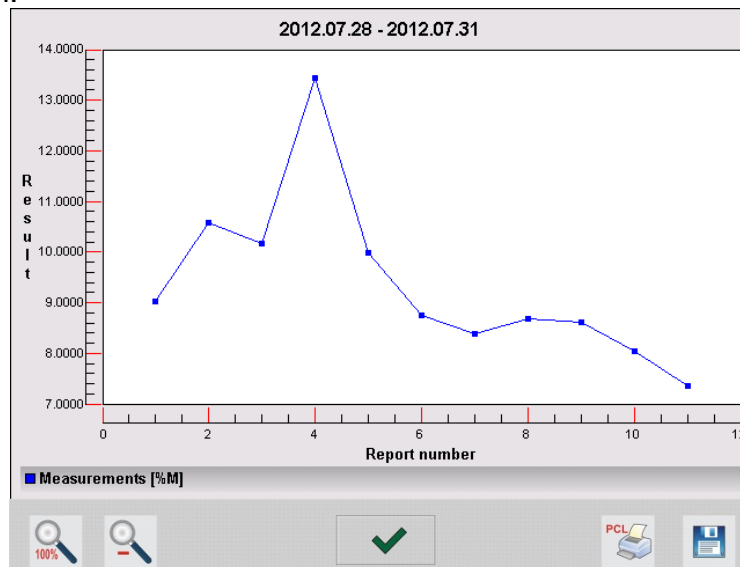

- Enter < Databases> submenu.
- Press < Drying reports statistics> entry.
- Select product, for which history of tests has to be generated.
- Determine searching criteria (start and end date).
- Press < Measurement graph> button.

Software generates graphs containing data on carried out drying process that are displayed in the coordinate system of Result/Measurement No.

An exemplary graph:



**Bottom bar tools:**

	Press to display complete graph.
	Press to zoom out the screen content.
	Press to go back to the previous window.
	Press to print the graph using PCL printer.
	Press to save the graph as *.bmp file to USB flash drive connected to USB port.

## 19.8. Minimum Sample Weight

Minimum sample weight database contains data concerning declared methods and minimum sample weights.

### CAUTION:

Only authorized RADWAG personnel can add new minimum sample weight records or make changes in those stored in the database.

### Procedure:

- Enter  Databases> submenu and press  Minimum sample weight> entry.
- Press  Add> button to add a new minimum sample weight, or
- Select already existing minimum sample weight by pressing the field with its name.

### List of parameters defined for minimum sample weights:

1. Name [name of a method used to determine minimum sample weight]
2. Code [method code]
3. Description [method overview]
4. Subsequent control [a field for entering expiry date of the minimum sample weight. 2 weeks before the expiry date, a pictogram of a clock is displayed next to the status pictogram. It is an information on the expiry date. Contact RADWAG representative to carry out necessary changes in minimum sample weight settings]
5. Thresholds [option that enables entering data on minimum sample weight mass and range of packaging mass (tare) with applicable criteria:  
**Tare** – maximum tare value, for which the minimum sample weight is obligatory.  
 You can enter three characteristic quantities: 0.000g, optional mass within weighing instrument's measuring range, and maximum capacity (see: examples below).  
**Minimum mass** – value of the minimum sample weight determined for a particular weighing device on site with use of respective method]

### Example no. 1 AS 220.3Y balance, $d=0.0001$ g:

List of MSW values determined for the following packaging values:

No.	Tare value	Minimum sample weight	Overview
1	0.0000 g	0.1000 g	Minimum sample weight refers to all net weight values when weighing is carried out without use of a tare container (<TARE> button NOT used).
2	10.0000 g	1.0000 g	Minimum sample weight refers to all net weight values when weighing is carried out using a tare container of mass ranging from 0.0001 g to 10.0000 g inclusive (<TARE> button used).
3	50.0000 g	2.5000 g	Minimum sample weight refers to all net weight values when weighing is carried out using a tare container of mass ranging from 10.0001 g to 50.0000 g inclusive (<TARE> button used).

4	200.0000 g	4.0000 g	Minimum sample weight refers to all net weight values when weighing is carried out using a tare container of mass ranging from 50.0001 g to 200.0000 g inclusive (<TARE> button used).
---	------------	----------	--

**Example no. 2 AS 220.3Y balance:**

No.	Tare value	Minimum sample weight	Overview
1	220.0000 g	0.5000 g	Minimum sample weight refers to all net weight values when weighing is carried out using a tare container of mass value comprised within the whole weighing range (<TARE> button used), and to all net weights that are weighed without a packaging (the <TARE> button not used).

**Example no. 3 AS 220.3Y balance:**



No.	Tare value	Minimum sample weight	Overview
1	0.0000 g	0.2500 g	Minimum sample weight refers to all net weight values when weighing is carried out without use of a tare container (<TARE> button NOT used). In case of such settings, the minimum sample weight is valid only when you weigh samples without use of tare containers. If taring function is used then pictogram informing on use of minimum sample weight goes blank and the software carries out weighing with tare (no determined minimum sample weight).

You can preview the entered data, but you are not allowed to edit it.

## 19.9. Ambient Conditions

<Ambient conditions> database contains parameters related to ambient conditions. Depending on the balance type the ambient conditions report can show values of temperature, humidity, atmospheric pressure. If the given balance is connected to a THB module then its indications are recorded to the database too.

### Procedure:



- Enter  Databases> submenu and press  Ambient conditions> entry.
- Select report, if not visible, scroll the list using navigation buttons.
- Record name includes data and time.

**Caution:** It is possible to use 'search by date' option.

## 19.10. Packaging

<Packages> database contains list of packages for which a name, code and mass value are specified. When carrying out weighing process, upon selection of particular packaging, a respective tare value is triggered automatically. The tare value is displayed with minus sign.

### Procedure:

- Enter  Databases> submenu and press  Packaging> entry.

- Press <  Add> button to design a new packaging.
- Select already existing packaging.



**Caution:** *It is possible to use 'search report' option.*

### 19.11. Warehouses

Depending on the organization of work, the warehouses database contains list of places used for picking up a sample for weighing/drying or list of places to which a weighed sample was delivered. Each warehouse has to have its name, code and description specified.

During weighing/drying process, and on selecting name of a warehouse, it is automatically assigned to the measurement result.

#### Procedure:



- Enter <  Databases> submenu and press <  Warehouses> entry.
- Press <  Add> button to add a new warehouse.
- Select an already existing warehouse.

**Caution:** *It is possible to use 'search report' option.*

### 19.12. Printouts

Printouts database contains all NON-STANDARD printouts. Each printout features a name, code and a template.



#### Procedure:

- Enter <  Databases> submenu and press <  Printouts> entry.
- Press <  Add> button to add a new printout be added.
- Select an already existing record.

**Caution:** *It is possible to use 'search report' option.*

#### Designing new printout template

##### Procedure:

- Enter <  Databases> submenu and press <  Printouts> entry.
- Press <  Add> button to create or edit a printout.

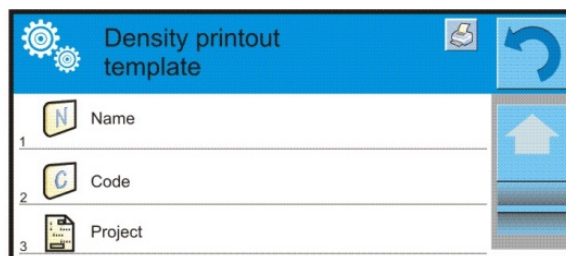
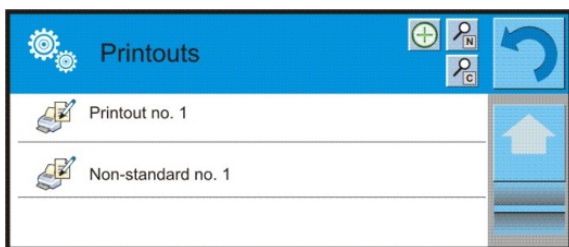

- Edit box opens, press <Project> entry.
- Respective box with an on-screen keyboard is displayed.



- Use the keyboard and create printout template.

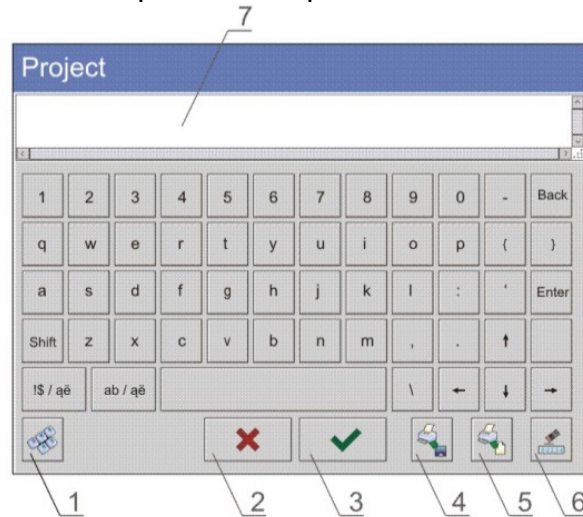

- 1 – zoom the edit box (7), recommended while using an external computer keyboard connected to module's USB port,
- 2 – cancel
- 3 – confirm
- 4 – download a printout template from a file
- 5 – list of variables
- 6 – delete all printout content
- 7 – edit box

- Save designed printout.

**Caution:** To delete characters press Back key. To move cursor, press navigation keys.

### Example of Printout no. 1 – large edit box

Project	Printout template
	<p>Moisture analyzer no. 400015            Moisture analyzer parameters:            Max = 220 g            d= 0.001 g</p> <p>Product name:            Date: 2011.10.24            Time: 11:48:06</p> <p>-----            Working mode: Weighing            -----</p> <p>Net weight: 94.147</p> <p>Carried out by: Admin</p>



### Example of Printout no. 2 – printout from a file

All printout templates can be designed in a form of external files, that are imported to a moisture analyzer; file extension: \*.txt or \*.lb. . External file shall contain all constant and variable data. Upon importing, the content of a printout template can be modified.



#### Procedure:

- Design a \*.txt or \*.lb file in an optional editor.
- Copy the file to a USB flash drive.
- Connect the USB flash drive to moisture analyzer's USB port.
- Press [4] < Download a printout from a file> button,
- Moisture analyzer's display shows data stored on the USB flash drive connected to the USB port.
- Select a file with printout template and press its name.
- The printout template is automatically copied to an editing field.

### 19.13. Universal Variables

Universal Variables are alphanumeric data which can be combined with printouts, products or other comparison-related information. Each variable has to have its name, code and value specified.

#### Procedure:

- Enter < Databases> submenu and press < **Var** Universal variables>.
- Press < Add> button to add a new variable be added.
- Select already existing universal variable, and modify the following fields: code, name, value.

**Caution:** It is possible to use 'search report' option.

### 19.14. Databases Management

Function allowing to manage databases data. It comprises three options: Export weighing database, Delete databases and Delete weighing records and reports.



### 19.14.1. Export Weighing Database to a File

All measurements are saved to <Weighing records> database and can be exported to a file using a USB flash drive.

#### Procedure:

- Connect the USB flash drive to USB A port.
- Press <Export weighing records database to a file> entry, a window for setting export options is opened.

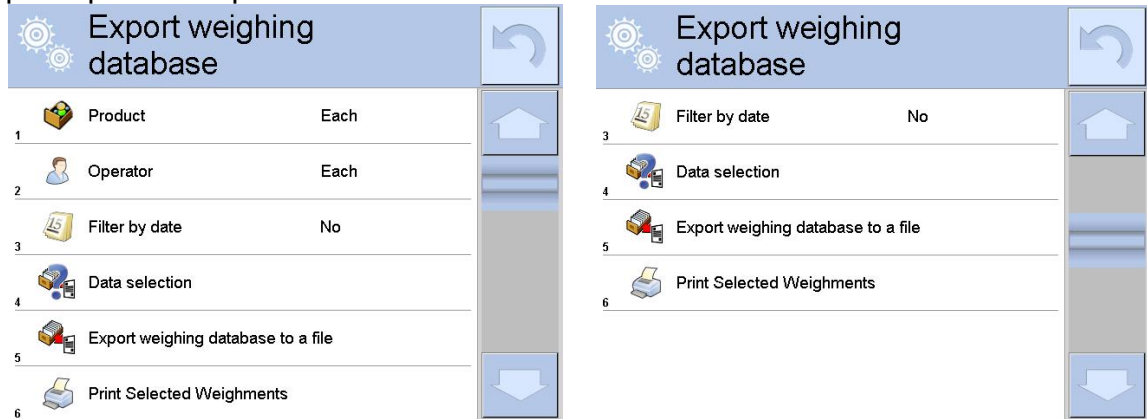

- <Data selection> parameter allows you to specify which data related to measurement is to be exported.

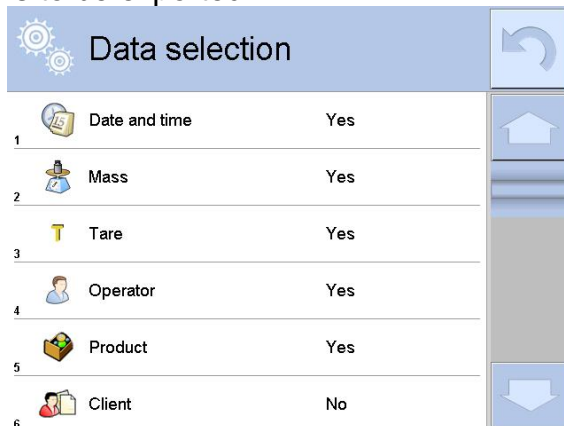

- Set respective data and press <Export weighing records database to a file> entry, weighing database is automatically exported. Upon operation completion the following message is displayed: „**Completed**” along with information on number of exported data and with file name (with \*.txt extension). Next previous window is displayed.

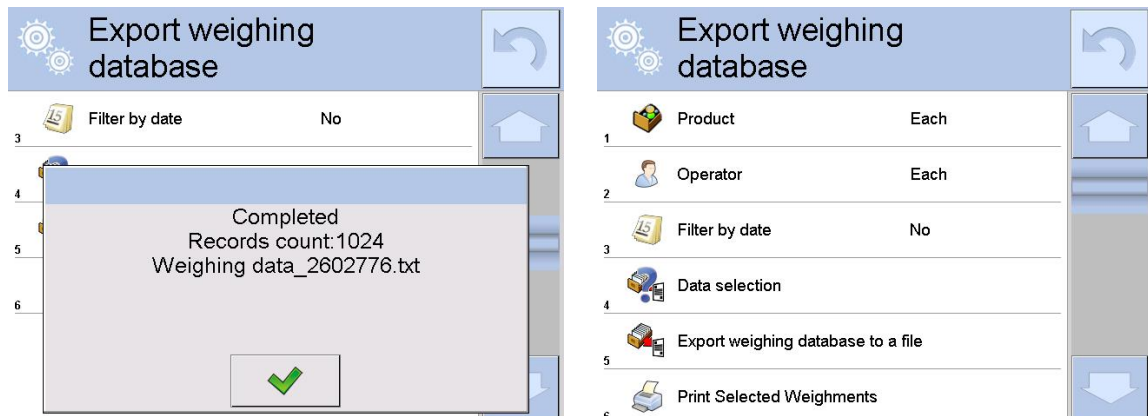

- You may return to a weighing procedure or proceed to other settings.

**Caution:** If moisture analyzer software cannot identify the USB flash drive, then upon pressing <Export weighings database to a file> entry, <Operation failed> message is displayed.

- A name of created file consists of database name and moisture analyzer serial number, e.g. <Weighing data\_364080.txt>.
- Unplug the USB flash drive from the USB port.

**Template of created file:**

The file is created in a form of graph, columns of which are separated with <Tab>. This allows for direct export of the file to <Excel> spread sheet document. The graph contains the following data: date and time, mass and mass unit, tare and tare unit, serial number, operator name, customer name, packaging name, source warehouse name, target warehouse name, control result name.

**19.14.2. Delete Databases**

Function allowing to delete data of selected database. Upon function activation, window with databases list is displayed, select database, delete respective data.

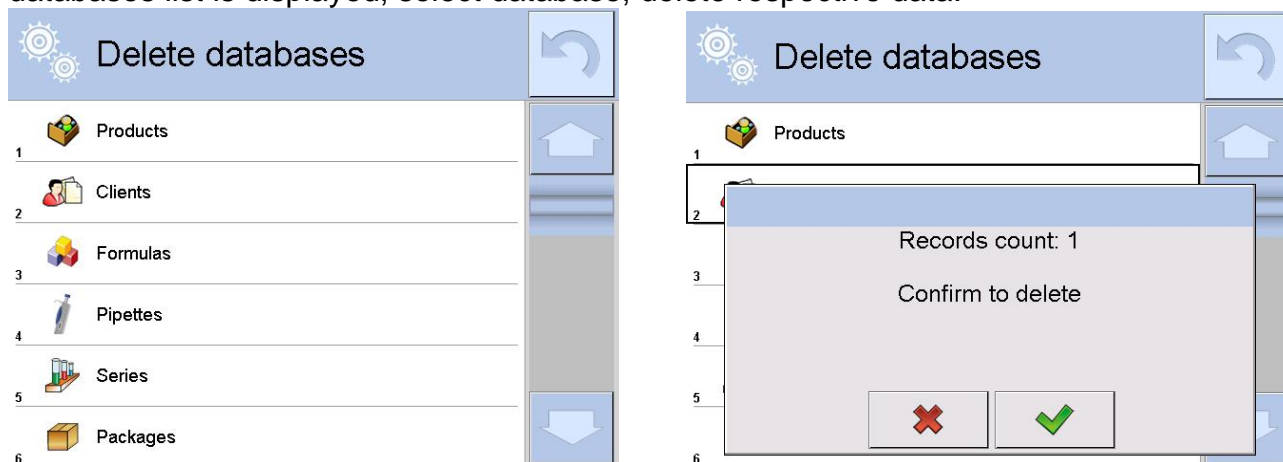

Upon confirmation, data is deleted and the following message is displayed:

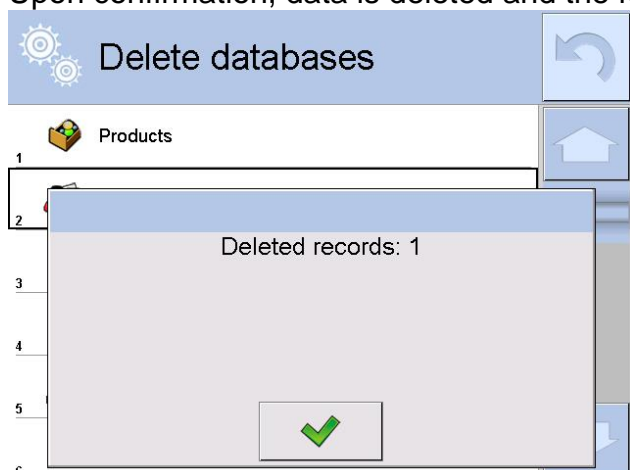

Upon confirmation the software returns to a previous window; you may continue weighing or proceed to other operations.

### 19.14.3. Delete Weighings and Reports

Function allowing you to delete weighings and reports of a given database. Activate <Delete weighing records and reports> parameter, a window with a numeric keyboard is displayed. Using the keyboard, enter a date specifying which data is to be removed. Date is given in the following form: year-month-day.



The screenshot shows a numeric keypad interface titled "Date". At the top, the date "2000 - 01 - 01" is displayed. Below the date are two buttons: a red "X" (cancel) and a green checkmark (confirm). The keypad itself consists of three rows of buttons: the first row contains digits 1 through 5; the second row contains digits 6 through 0; and the third row contains "Tab", left and right arrow keys, "Back", and "Del".

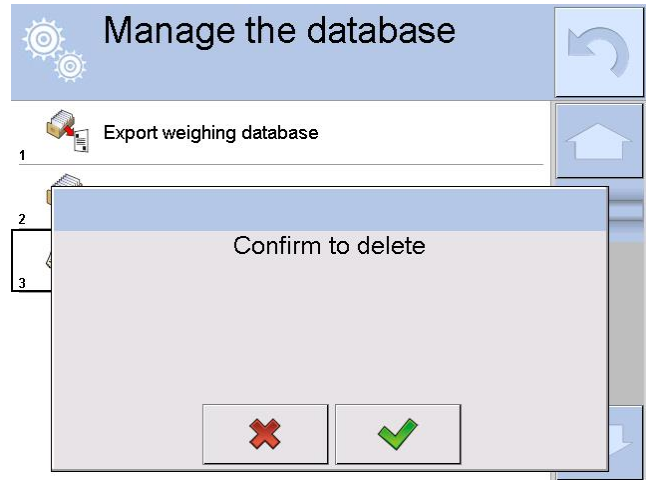

The screenshot shows the "Manage the database" window. The title bar includes a gear icon and a refresh icon. Below the title bar is a menu item "Export weighing database" with a document icon. A dialog box titled "Confirm to delete" is overlaid on the window. The dialog box contains a red "X" button and a green checkmark button. The background window is partially obscured by the dialog box.

Confirm the date, all weighings and reports older than those specified by the date are removed. Quantity of deleted weighings and reports is displayed.

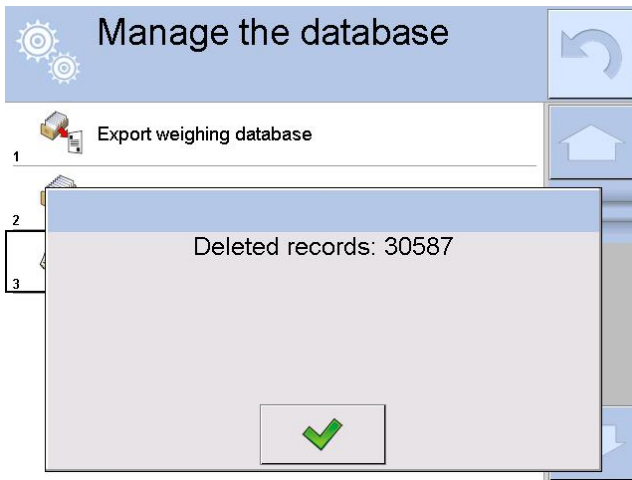







The screenshot shows the "Manage the database" window after the deletion process. The dialog box now displays the text "Deleted records: 30587" and a green checkmark button. The background window is partially obscured by the dialog box.

## 20. COMMUNICATION

To access  Communication menu press Setup key or <Setup  > quick access button.

The moisture analyzer can communicate with peripheral devices, the communication is established via the following ports:

-  COM 1 (RS232),
-  COM 2 (RS232),
-  Ethernet,
-  Wi-Fi,
-  TCP.

The ports are to be configured in < Communication> parameter.

### 20.1. RS 232 Settings

#### Procedure:

- Select communication port < COM1> or < COM2>.
- Next, set respective values:

There are following transmission parameters for RS 232 ports:

- Baud rate - 4800, 9600, 19200, 38400, 57600, 115200 bit/s
- Data bits - 5, 6, 7, 8
- Stop bits - None, 1, 1.5, 2
- Parity - None, Odd, Even, Marker, Space

### 20.2. ETHERNET Settings

#### Procedure:

-  Select <Ethernet> port, set respective transmission parameters:
  - DHCP - Yes / No
  - IP Address - 192.168.0.2
  - Subnet mask - 255.255.255.0
  - Default gateway - 192.168.0.1

#### **CAUTION:**

*Above settings are for information purpose only. Set the transmission parameters in accordance with your local network.*

Upon completing modifications, press  button, the following message is displayed:  
<Restart balance to implement changes>.

Return to weighing mode and restart the device.

### 20.3. Wi-Fi Settings

Moisture analyzer equipped with Wi-Fi module displays respective pictogram:



## Procedure:

- Select < Wifi> communication interface. Set the following parameters:
  - DHCP - Yes / No
  - IP Address - 10.10.9.155
  - Subnet mask - 255.255.255.0
  - Default gateway - 10.10.8.244

## CAUTION:

Above settings are for information purpose only. Set the transmission parameters in accordance with your local network.

Upon completing modifications, press  button, the following message is displayed:

<Restart balance to implement changes>.

Return to weighing mode and restart the device.

You may use <Available networks> parameter to view the list of networks detected by the module:

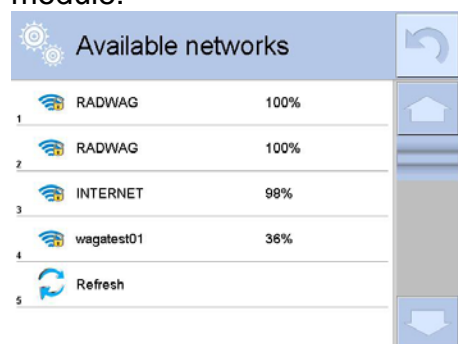

Pictogram with a padlock means that the password is required. Press <Refresh> pictogram to search for available networks.

Press <Network status> entry to check selected network parameters. The following message is displayed:

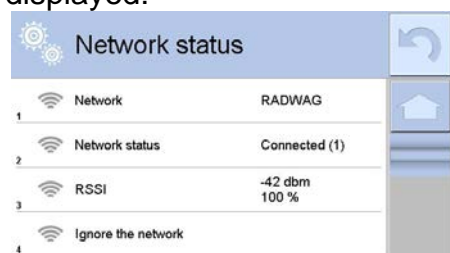





The selected network and connection parameters are saved to moisture analyzer memory. The program connects to the network in accordance with the memory-saved parameters each time the moisture analyzer is switched on. To change this, select <Ignore the network> entry. Given network gets disconnected.



## 20.4. TCP Settings

TCP (*Transmission Control Protocol*) operating in customer-server mode enables communication of two computers. You can establish connection on port specified by server.



### Procedure:

- Enter < Communication> parameters.
- Select < Tcp /  Port>; <Port> window with an on-screen keyboard is opened.
- Insert required port number and press  button to confirm.



## 21. PERIPHERALS

To access  Peripherals menu press Setup key or <Setup  > quick access button. Peripherals menu provides list of devices that can be integrated with the moisture analyzer.

### 21.1. Computer

 pictogram displayed on the top of the home screen signals active connection between a moisture analyzer and a computer. < Computer> submenu enables connection configuration.

#### Procedure:

- Press  key and next press < Peripherals/  Computer>.
- Set parameters related to cooperation with a computer.
  - Computer Port  
Available options: none, COM 1, COM 2, TCP,
  - Address:  
Give address of moisture analyzer connected to a computer,
  - Continuous transmission  
Available options: NO, YES (*printout format is conditioned by set weighing printout template – see parameter below*),
  - Printout template for weighing  
parameter enabling you to design customized printout, for this, use window with printout template. For detailed information on printouts refer to section *PRINTOUTS* of this user manual.
  - E2R System:  
E2R System performs supervision and control over all weighing and drying processes carried out using moisture analyzer.

#### CAUTION:

< **E2R System**> can only be activated by moisture analyzer manufacturer or by authorized personnel.

*If cooperation with E2R is enabled, then all changes regarding products, customers, operators, drying programs, etc. are possible to be carried out only via E2R computer software.*

*Access to modifications via moisture analyzer's software is locked.*

## 21.2. Printer

<Printer> submenu allows you to:

- set port for establishing communication with a printer,
- define printer's code page (by default: 1250)
- define control codes for PCL printer or EPSON receipt printer.
- define printout templates.

To ensure correct cooperation of the moisture analyzer with the printer (correct printout of diacritical signs of a given language), respective baud rate, obligatory for a given printer, must be selected (read the printer settings). Additionally code page of a sent printout must be accordant with a code page of a printer.

There are two methods for obtaining code page accordance:

- by setting the right code page in the settings of a printer (read the printer manual) – respective to printout code page set in a module; or
- by sending control code, from a moisture analyzer to the printer, which automatically sets the right code page (respective to code page set in a moisture analyzer) in advance before execution of the data printout – it is possible only for printers equipped with such option.

*Exemplary moisture analyzer settings for correct cooperation (printout of Polish signs) with EPSON thermal printer connected to RS232 port:*

### 1. EPSON TM-U220B

*Communication parameters for port to which the printer is connected:*

- *baud rate* – 9600 bit/s
- *data bits* – 8
- *stop bits* – 1
- *parity* – none

*Printer parameters:*

- *port* – COM 1 or COM 2 (the one to which the printer is connected)
- *code page* – 852

### 2. EPSON TM-T20

*Communication parameters for port to which the printer is connected:*

- *baud rate* – 38400 bit/s
- *data bits* – 8
- *stop bits* – 1
- *parity* – none

*Printer parameters:*

- *port* – COM 1 or COM 2 (the one to which the printer is connected)
- *code page* – 1250
- *control codes* – 1B742D

*Printer parameters:*

- *port* – COM 1 or COM 2 (the one to which the printer is connected)
- *code page* – **852**
- *control codes* – **1B7412**



Default values for particular printouts:

Product printout template	{50}
	{51}
Operator printout template	{75}
	{76}
Customer printout template	{85}
	{86}
Warehouse printout template	{130}
	{131}
Package printout template	{80}
	{81}
	{82}

Ambient conditions printout template

```
----- AMBIENT CONDITIONS-----  
Date and time                {275}  
Temperature of sensor 1:     {value} °C  
Temperature of sensor 1:     {value} °C  
THBS temperature:           {value} °C  
THBS humidity:               {value} %  
-----
```

Drying Program printout template	{380}
	{381}

### 21.3. Barcode Scanner

The moisture analyzer can integrate with a barcode scanner. The barcode scanner is used to facilitate quick search for database records:

- Products,
- Operators,
- Customers,
- Packages,
- Warehouses,
- Universal variables,

To configure barcode scanner enter:



„ /  **Peripherals/**  **Barcode scanner**”.

**CAUTION:**

Enter < **Communication**> submenu and set baud rate for a barcode scanner (by default 9600b/s). For detailed description of 'module' - 'barcode scanner' communication read **APPENDIX E** of this user manual.

### 21.3.1. Port



#### Procedure:

- Enter < **Peripherals**> parameter and select „ **Barcode scanner** /  **Port**” .  
Select respective option:

Ports for moisture analyzer – scanner communication:

- RS 232 (COM1),
- RS 232 (COM2),
- USB

### 21.3.2. Prefix/Suffix





You can edit < **Prefix**> and < **Suffix**> to synchronize moisture analyzer’s software with barcode scanner.

#### CAUTION:

*In RADWAG-adopted standard, the prefix is 01 sign (byte) hexadecimal format, the suffix is 0D sign (byte) hexadecimal format.*

*For detailed description of 'module' - 'barcode scanner' communication read **APPENDIX E** of this user manual.*



#### Procedure:

- Enter < **Barcode scanner**> submenu,
- Select < **Prefix**> parameter and enter hexadecimal value using on-screen keyboard.  
Press  button to confirm.
- Select < **Suffix**> parameter and enter hexadecimal value using on-screen keyboard.  
Press  button to confirm.

### 21.3.3. Field Selection

Parameter allowing you to specify, for which field the search is to be carried out in particular databases.

#### Procedure:

- Enter < **Peripherals**> submenu,
- Select „ **Barcode scanner** /  **Field selection**” . List of fields is displayed:



Product



Operator



Customer



Universal variable 1



Universal variable 2



Universal variable 3



Packaging



Universal variable 4



Warehouse



Universal variable 5

- Select one item from the list. The following parameters may be edited:

	<b>Filtering</b>	Declaring search criteria (see table below)
	<b>Offset</b>	Parameter allowing you to set the first significant code's character, All preceding characters are omitted.
	<b>Length of Code</b>	Declaring the quantity of code's characters to be taken into account during search procedure.
	<b>Start marker</b>	Declaring the starting point of scanned code used for searching.
	<b>End marker</b>	Declaring the ending point of scanned code used for searching.
	<b>Ignore marker</b>	Determining whether start and end markers are to be used when comparing scanned code with the code saved to the moisture analyzer.



#### Filtering criteria conditioned by field type:

Field Selection	Filtering
Product	None, Name, Code, EAN code
Operator	None, Name, Code,
Customer	None, Name, Code,
Packaging	None, Name, Code,
Warehouse	None, Name, Code,
Formulation	None, Name, Code,
Pipette	None, Name, Code,
Series	None, Name, Code,
Universal variables	None, Active

#### 21.3.4. Test

 **<Test>** parameter allowing you to verify if operation of a barcode scanner connected to a moisture analyzer is correct.

##### Procedure:

- Enter  **<Barcode scanner>** submenu,
- Select  **<Test>** parameter; **<Test>** edit box is displayed, it features ASCII and HEX fields.
- The code is scanned and entered to the ASCII field and HEX field, next the test result is displayed in the bottom part.

## When:

- <Prefix> and <Suffix> declared in moisture analyzer settings comply with <Prefix> and <Suffix> of the scanned code, the test result is <Positive>,
- <Prefix> and <Suffix> declared in moisture analyzer settings do not comply with <Prefix> and <Suffix> of the scanned code, the test result is <Negative>,

## 21.4. Transponder Card Scanner

You can log in to the moisture analyzer by means of:

- password entered using an on-screen keyboard,
- registered transponder card scanner.

### CAUTION:

*For correct moisture analyser cooperation with a transponder card scanner set appropriate baud rate value in < Communication> submenu (default 9600b/s).*





## Transponder card scanner port

Communication between the weighing device and the transponder card scanner can be established via the following ports:

- RS 232 (COM1),
- RS 232 (COM2).

In order to log in an operator via transponder card scanner, first assign a number of an already registered card to a selected operator in the database of operators.

## Procedure:

- Connect a transponder card scanner to a given port (RS 232 COM1 or RS 232 COM2), select communication port for moisture analyzer- transponder card scanner communication.
- In < Communication> submenu set baud rate compatible with the one of the transponder card scanner (default 9600b/s).
- Enter operators database, go to < Card no.> parameter and edit desired operator's record.
- On entering editing mode in < Card no.> parameter, a <Card no.> edit box is opened with an on-screen keyboard.
- Approximate the card to the transponder card scanner. The moisture analyzer automatically displays number of detected card in the <Card no.> entry.
- Accept recognized number by pressing  button and return to the weighing.



## 21.5. Additional Display





Parameter allowing you to set port for communication between the weighing device and the additional display. Available ports:

- RS 232 (COM1),
- RS 232 (COM2),
- TCP.

Type of data displayed on an additional display is declared in <Project> variable.

### Procedure – designing a variable:

- Enter < Peripherals> submenu.
- Select < Additional display/ Project> entry, a <Project> edit box with an on-screen keyboard is displayed.
- Enter required value using an on-screen keyboard or

- Press    button and select required value from the list.
- Press  button to confirm.

**CAUTION:**

For default settings  *Reference sample mass* has a variable set to value {140}.  
Function valid for weighing mode exclusively.

## 22. INPUTS/OUTPUTS

**Application of inputs:**

The set of inputs is used to control moisture analyzer's operation. The following functions or keys can be assigned to each of 4 inputs:







- |  |  |
|--|--|
| <input type="radio"/> Checkweighing thresholds | <input type="radio"/> Right door                           |
| <input type="radio"/> Target value             | <input type="radio"/> Parameters                           |
| <input type="radio"/> Profile                  | <input type="radio"/> Statistics                           |
| <input type="radio"/> Adjustment               | <input type="radio"/> Add to statistics                    |
| <input type="radio"/> Zero                     | <input type="radio"/> Product                              |
| <input type="radio"/> Tare                     | <input type="radio"/> Warehouse                            |
| <input type="radio"/> Set tare                 | <input type="radio"/> Customer                             |
| <input type="radio"/> Disable tare             | <input type="radio"/> Parts counting: Set part mass        |
| <input type="radio"/> Restore tare             | <input type="radio"/> Parts counting: Determine part mass  |
| <input type="radio"/> Packaging                | <input type="radio"/> Percent weighing: set reference mass |
| <input type="radio"/> Print                    | <input type="radio"/> Percent weighing: set 100%           |
| <input type="radio"/> Print header             | <input type="radio"/> Solid density                        |
| <input type="radio"/> Print footer             | <input type="radio"/> Liquids Density                      |
| <input type="radio"/> Universal variable 1÷ 5  | <input type="radio"/> Air density                          |
| <input type="radio"/> Accept                   | <input type="radio"/> Automatic Weight Crane Control       |
| <input type="radio"/> Abort                    | <input type="radio"/> Task                                 |
| <input type="radio"/> Operator                 | <input type="radio"/> Reference weight                     |
| <input type="radio"/> Left door                |  |

Upon change of the logic status of the input system, e.g. from [0] to [1], a function that is assigned to the system is carried out.

For instance:

- display of set Min, Max thresholds or
- restoring tare value .

**Procedure:**

- Press  key and next press:   *Inputs/Outputs*.
- Enter   *Inputs/Outputs* submenu and select   *Inputs* parameter.
- Edit a selected input; list of available functions is displayed.
- Select a given function and return to weighing.

### Application of outputs:



Outputs are used to SIGNAL the status of measurement result. Change of logic status of the output system, e.g. from [0] to [1], takes place on meeting a requirement assigned to the output.

The following data can be assigned to each of 4 outputs:

<b>Option</b>	<b>Moisture analyzer status switching output logic.</b>
None	-----
Stable	Each stable measurement switches the logic state.
MIN stable	Stable measurement below [MIN] threshold switches the logic state.
MIN unstable	Unstable measurement below [MIN] threshold switches the logic state.
OK stable	Stable measurement within [MIN] [MAX] thresholds switches the logic state.
OK unstable	Unstable measurement within [MIN] [MAX] thresholds switches the logic state.
MAX stable	Stable measurement below [MAX] threshold switches the logic of the system.
MAX unstable	Unstable measurement below [MAX] threshold switches the logic of the system.
Confirmation of cycle completion	End of procedure.

### Procedure:

Press  key and next press: <  Inputs/Outputs >.

Enter <  Inputs/Outputs > submenu and select <  Inputs > parameter.

Edit a selected output; list of available functions is displayed.

Select given function from the list, next return to weighing and save changes.

## 23. MISCELLANEOUS

This menu contains parameters facilitating moisture analyzer operation such as: language, date-time, beep sound, display adjustment, level control.

To enter <Misc.> submenu, press  key and next press  Misc.> button.

### 23.1. Interface Language

#### Procedure:

Enter  Misc.> submenu.

Select  Language> parameter and select language.

Available languages: Polish, English, German, French, Spanish, Korean, Turkish, Chinese, Italian, Czech, Romanian, Hungarian, Russian.

### 23.2. Date and Time



You can set date, time and their formats.

There are two ways to edit date and time settings:

- Press **<Date and time>** entry (home screen's top bar).
- Go to  /  **Misc./**  **Date and time>**.

Enter date and time settings, an on-screen keyboard is displayed. Set date and time in the following order: year, month, day, hour, minute. Press  button to confirm.

Additional functions of:  /  **Misc./**  **Date and time>** contains additional functions for defining date and time format:

Pictogram	Name	Value	Description
	Date format	yyyy.MM.dd *	Enter this parameter to set date format. Options: d.M.yy, d/M/yy, d.M.yyyy, dd.MM.yy, dd/MM/yy, dd-MM-yy, dd.MM.yyyy, dd/MM/yyyy, dd-MMM-yy, dd.MMM.yyyy, M/d/yy, M/d/yyyy, MM/dd/yy, MM/dd/yyyy, yy-M-dd, yy/MM/dd, yy-MM-dd, yyyy-M-dd, yyyy.MM.dd, yyyy-MM-dd.
	Time format	HH:mm:ss **	Enter this parameter to set time format. Options: H.mm.ss, H:mm:ss, H-mm-ss, HH.mm.ss, HH:mm:ss, HH-mm-ss, H.mm.ss tt, H:mm:ss tt, H-mm-ss tt, HH.mm.ss tt, HH:mm:ss tt, HH-mm-ss tt, h.mm.ss tt, h:mm:ss tt, h-mm-ss tt, hh.mm.ss tt, hh:mm:ss tt, hh-mm-ss tt

\*) - For date format: y – year, M – month, d – day

\*\*) - For time format: H – hour, m – minute, s – second

 <Date and time> parameter enables previewing declared date and time formats.

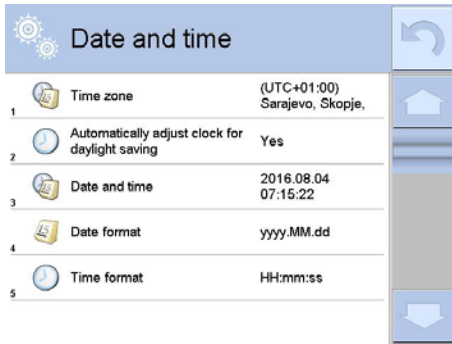

**CAUTION:**

< Date and time > parameter can be accessed only by an operator with appropriate permissions. Permissions level can be modified by administrator in <Permissions> menu.

### 23.3. „Beep” Sound

**Procedure:**

Enter < Misc.> submenu, select < Beep > parameter and set appropriate option:  
 None - Beep sound disabled for keys/buttons and proximity sensors  
 Keys/Buttons - Beep sound enabled for keys/buttons  
 Sensors - Beep sound enabled for proximity sensors  
 All - Beep sound enabled for keys/buttons and proximity sensors

### 23.4. Volume

You can change volume of the loudspeaker mounted in the weighing indicator.

**Procedure:**

Press key and next press: < Misc./Volume >.  
 An on-screen keyboard is displayed. Enter volume in percent: 100% - maximum volume, 0% - minimum volume (loudspeaker off).

### 23.5. Sleep Mode

You can turn on display sleep mode.

**Procedure:**

Press key and next press: < Misc./Display sleep mode >.  
 Select one of the following options: [None; 1; 2; 3; 5; 10; 15]. Digits stand for minutes. The software returns to the previous menu.

**CAUTION:**

*Display turns to sleep mode only when the moisture analyzer is not operated (the indication on the screen remains the same). Upon mass change, or pressing any key on the panel, the moisture analyzer returns to weighing.*

### 23.6. Display Brightness

Display brightness influences duration of battery-powered moisture analyzer operation. To make the balance work longer, reduce screen brightness.

**Procedure:**



Press key and next press: < Misc./Display brightness >.  
 Enter desired value: [0% - 100%]. Display brightness changes automatically, the previous menu is displayed.



## 23.7. Touch Panel Calibration

Display calibration is required if the touch panel does not react correctly during operation.

### Procedure:

- Enter < <Misc.> submenu.
- Select < Touch panel calibration> parameter, an edit box is displayed.
- Use finger or a thin (but not sharp edged) and soft stylus to press and hold a display area with a cross. After pressing the fifth cross in order, accept the changes by pressing  key.

**Caution:** The process can be aborted by pressing Esc key on an external keyboard connected to the moisture analyzer indicator.

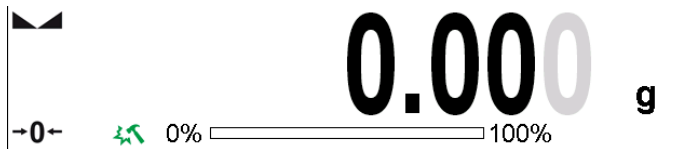

## 23.8. Vibrations Detection

The program detects incorrect loading of the weighing pan with the sample. Incorrectness with regard to loading can lead to increased indication errors. Activation of 'Vibrations detection' function is signalled with display of respective pictogram in weighing result window.



If incorrectly carried out loading is detected, the pictogram turns to red . The measurement result may be affected by a greater error.



### Procedure:

- Enter < <Misc.> submenu.
- Select < Vibrations detection> entry,
- Select one of available options:
  - Yes – function on
  - No – function off

## 23.9. Level Control

The moisture analyzer is equipped with Automatic Level Control mechanism or external level device.

You can define its operation for non-verified devices.

- Enter < <Misc.> submenu.
- Select < Level control> parameter, an edit box is displayed.
- Select one of available options:
  - None – level indicator not displayed, the moisture analyzer does not control level status,
  - Active – level indicator is displayed, the moisture analyzer alerts level change by changing colour of level indicator (green→ level status OK, red→ level status lost),
  - Active with lock – level indicator is displayed, the moisture analyzer alerts level change by changing colour of level indicator (green→ level status OK, red → level

status lost). For red level indicator 'no Level' alert is displayed - weighing function is blocked.

**CAUTION:**

For detailed information on moisture analyzer leveling refer to section 16.3 of this user manual.

### 23.10. Proximity Sensors Sensitivity

The parameter is adjustable between 0 – 9, and it determines the distance from which the IR proximity sensors react.

As standard, the sensitivity is set within the range of 5 to 7.

Procedure:

- Enter  <Misc.> submenu.
- Select <Proximity sensors sensitivity> parameter, an edit box is displayed.
- Select one of available options. The selection causes immediate returning to the menu window.

### 23.11. Proximity Sensors Timeout

Parameter for setting timeout of proximity sensors expressed in [ms].

Default value: <0>.

When you use the option of motion recognition set <Proximity sensors timeout> parameter to <500ms> entry.

Procedure:

- Enter  <Misc.> submenu.
- Select <Proximity sensors timeout> parameter, an on-screen keyboard is displayed.
- Enter <500> entry.
- Confirm. Menu is displayed.



### 23.12. Autotest

Option disabled for moisture analyzer.

### 23.13. Start-Up Logo

**Caution:** (option enabled only for authorized moisture analyzer operators)

The parameter enables you to change logo that is displayed on moisture analyzer start-up.



### 23.14. Export of System Events

**CAUTION:**

(option enabled only for authorized moisture analyzer operators)

The parameter enables you to generate a special type of a file that is automatically saved to a USB flash drive, plugged to USB port. The file helps RADWAG service to diagnose cause of problems occurring during moisture analyzer operation.

**Procedure:**

- Plug a USB flash drive to moisture analyzer's USB port.
- Enter <img alt="hand cursor icon" data-bbox="210 95 235 115"/> Misc.> submenu.
- Select <Export system events> parameter.
- The software generates a file and automatically saves it on the USB flash drive.
- The generated file has to be sent to RADWAG.

## 24. UPDATE

Update function enables update of:

- Help files available from the operator level.
- Application APPLICATION.
- Metrological parameters: main board (administrator exclusively).

Update takes place automatically by loading data from a USB flash drive connected to moisture analyzer's USB port.

**Procedure:**

- Prepare a USB flash drive with update file. Required file extension: \*.lab2.
- Connect the USB flash drive to moisture analyzer's USB port.
- Select <Application> entry.
- The display previews content of the USB flash drive, search for the update file and press its name.
- Updating proceeds automatically.

Update of help files and the main board file is analogous; required files extensions are: \*.hlp - help, \*.mbu – main board.

## 25. ABOUT (system info)

'About' menu provides information on moisture analyzer and moisture analyzer program. Most of parameters in this menu are for the information purpose only.



<Ambient conditions> parameter enables preview of current ambient conditions: temperature, humidity, pressure (if the moisture analyzer features ambient conditions sensors). <Print settings> parameter enables you to send all parameters to printer port.

## 26. VIDEOS

Videos menu enables display of instruction videos (\*.wmv) presenting how to operate the moisture analyzer.

Administrator can add/delete videos.

To add a video follow the below procedure:

1. Save the video on a USB flash drive.
2. Plug the drive to the USB port.
3. Enter <Videos> submenu.
4. Press <+> button located on the top.
5. Select respective file.
6. The video is saved to the balance memory.

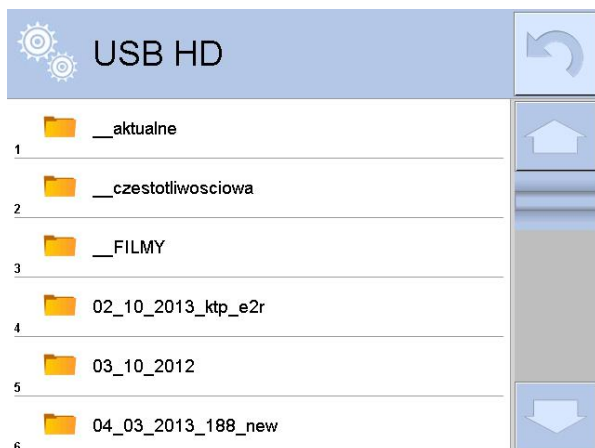

To play the video you have to:

1. Save the video to the balance memory (see instruction above).
2. Enter <Videos> submenu.

3. Press the name of a video to be played.

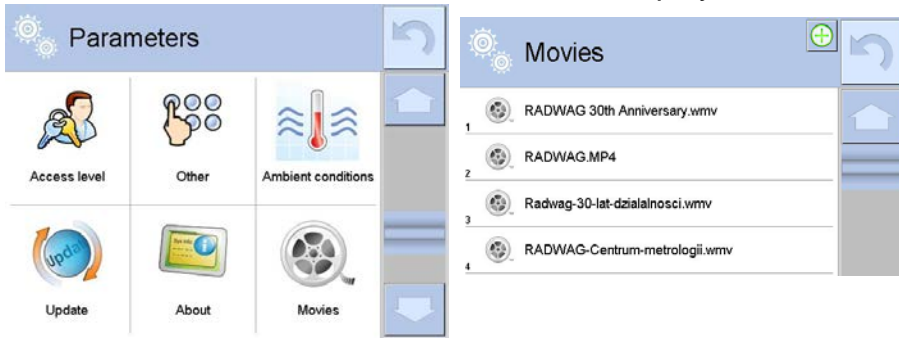

The video starts automatically.  
Navigation buttons:

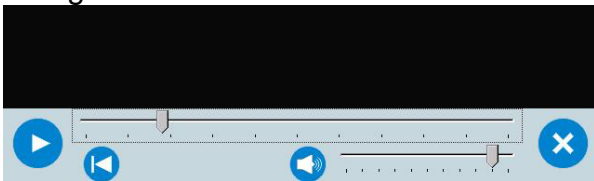

	Play/ Pause playing
	Stop playing
	Increase/decrease the volume (volume power adjusted, for settings go to <Misc.> menu).
	Enabling/Disabling the volume
	Restart video

## 27. COMMUNICATION PROTOCOL

### GENERAL INFORMATION

- A. A character based communication protocol (moisture analyzer-indicator) is designed for establishing communication between a RADWAG balance and a peripheral device via RS-232C interface.
- B. The protocol consists of commands sent from a peripheral device to the moisture analyzer and responses from the moisture analyzer.
- C. Responses are sent from the moisture analyzer each time a command is received.
- D. Commands, forming the communication protocol, enable obtaining data on moisture analyzer status and facilitate influencing moisture analyzer operation, e.g.: acquiring measurement results from the weighing device, zeroing, etc.

### 27.1. List of Commands

Command	Command overview
<b>Z</b>	Zeroing
<b>T</b>	Taring
<b>OT</b>	Give tare value
<b>UT</b>	Set tare

<b>S</b>	Send stable measurement result in basic measuring unit
<b>SI</b>	Immediately send measurement result in basic measuring unit
<b>SIA</b>	Immediately give results from all platforms in basic measuring units
<b>SU</b>	Send stable measurement result in current measuring unit
<b>SUI</b>	Immediately send measurement result in current measuring unit
<b>C1</b>	Switch on continuous transmission in basic measuring unit
<b>C0</b>	Switch off continuous transmission in basic measuring unit
<b>CU1</b>	Switch on continuous transmission in current measuring unit
<b>CU0</b>	Switch off continuous transmission in current measuring unit
<b>DH</b>	Set min checkweighing threshold
<b>UH</b>	Set max checkweighing threshold
<b>ODH</b>	Give value of min checkweighing threshold
<b>OUH</b>	Give value of max checkweighing threshold
<b>SM</b>	Set mass value of a single item
<b>TV</b>	Set target mass value
<b>RM</b>	Set reference mass value
<b>NB</b>	Give module serial number
<b>PROFILES</b>	Set balance profile
<b>PRG</b>	Give set profile name
<b>LOGIN</b>	User logging
<b>LOGOUT</b>	User logout
<b>SS</b>	Value release
<b>IC</b>	Internal adjustment performance
<b>IC1</b>	Disable automatic internal adjustment of the module
<b>IC0</b>	Enable automatic internal adjustment of the module
<b>K1</b>	Lock scale keypad
<b>K0</b>	Unlock scale keypad
<b>BP</b>	Activate sound signal
<b>OMI</b>	Give available working modes
<b>OMS</b>	Set working mode
<b>OMG</b>	Give current working mode
<b>PC</b>	Send all implemented commands
<b>BN</b>	Give scale type
<b>FS</b>	Give max capacity
<b>RV</b>	Give program version
<b>A</b>	Set AUTOZERO function
<b>EV</b>	Set ambient conditions state
<b>EVG</b>	Give set ambient conditions state

<b>FIS</b>	Set filter
<b>FIG</b>	Give current filter setting
<b>ARS</b>	Set value release
<b>ARG</b>	Give current value release setting
<b>LDS</b>	Set last digit
<b>UI</b>	Give accessible units
<b>US</b>	Set current unit
<b>UG</b>	Give current unit
<b>NT</b>	Integration with PUE 7.1, PUE 10 indicator

**Caution:** Each command must end with CR LF characters.

## 27.2. Response Format

On receipt of a command, the indicator responds as follows:

XX_A CR LF	command understood and in progress
XX_D CR LF	command carried out (appears only after the XX_A command)
XX_I CR LF	command understood but not accessible at this moment
XX_^ CR LF	command understood but max threshold is exceeded
XX_v CR LF	command understood but min threshold is exceeded
XX_OK CR LF	command carried out
ES_CR LF	command not recognised
XX_E CR LF	time limit exceeded while waiting for stable measurement result (time limit is a characteristic module parameter)

**XX** - stands for a name of a sent command

\_ - space

## COMMANDS OVERVIEW

### Zeroing

Format: **Z CR LF**

Response options:

Z\_A CR LF - command understood and in progress

Z\_D CR LF - command carried out

Z\_A CR LF - command understood and in progress

Z\_^ CR LF - command understood but zeroing range is exceeded

Z\_A CR LF - command understood and in progress

Z\_E CR LF - time limit exceeded while waiting for stable measurement result

Z\_I CR LF - command understood but not accessible at this moment

### Taring

Format: **T CR LF**

Response options:

T\_A CR LF - command understood and in progress

T\_D CR LF - command carried out

T\_A CR LF - command understood and in progress

T\_v CR LF - command understood but taring range is exceeded

T\_A CR LF - command understood and in progress

T\_E CR LF - time limit exceeded while waiting for stable measurement result

T\_I CR LF - command understood but not accessible at this moment

### Give tare value

Format: **OT CR LF**

Response: **OT\_TARE CR LF** - command carried out.

Response format:

1	2	3	4-12	13	14	15	16	17	18	19
O	T	space	tare	space	unit			space	CR	LF

**Tare** - 9 characters, right justification

**Unit** - 3 characters, left justification

**Caution:** Tare value is always given in an adjustment unit.

### Set Tare

Format: **UT\_TARE CR LF**, where **TARE** - tare value.

Response options:

UT\_OK CR LF - command carried out

UT\_I CR LF - command understood but not accessible at this moment

ES CR LF - command not recognised (tare format incorrect)

**CAUTION:**

*Use dot in tare format as decimal point.*

### Send stable measurement result in basic measuring unit

Format: **S CR LF**

Response options:

S\_A CR LF - command understood and in progress

S\_E CR LF - time limit exceeded while waiting for stable measurement result

S\_I CR LF - command understood but not accessible at this moment

MASS FRAME - command carried out, immediate response: mass value in basic measuring unit

Response format:

1	2-3	4	5	6	7-15	16	17	18	19	20	21
S	space	stability marker	space	character	mass	space	unit			CR	LF

**Example:**

**S CR LF** - command sent from a computer

**S\_A CR LF** - command understood and in progress



**S** \_\_\_\_\_ **8 . 5 \_ g \_ CR LF** - command carried out, immediate response: mass value in current measuring unit.

where: \_ - space

**Immediately send measurement result in basic measuring unit**

Format: **SI CR LF**

Response options:

SI\_I CR LF - command understood but not accessible at this moment

MASS FRAME - immediate response: mass value in basic measuring unit

Response format:

1	2	3	4	5	6	7-15	16	17	18	19	20	21
S	I	space	stability marker	space	character	mass	space	unit		CR	LF	

**Example:**

**SI CR LF** - command sent from a computer

**SI ? \_\_\_\_\_ 1 8 . 5 \_ k g \_ CR LF** - command carried out, immediate response: mass value in basic measuring unit

where: \_ - space

**Send stable measurement result in current measuring unit**

Format: **SU CR LF**

Response options:

SU\_A CR LF - command understood and in progress

SU\_E CR LF - time limit exceeded while waiting for stable measurement result

SU\_I CR LF - command understood but not accessible at this moment

MASS FRAME - command carried out, immediate response: mass value in basic measuring unit

Response format:

1	2	3	4	5	6	7-15	16	17	18	19	20	21
S	U	space	stability marker	space	character	mass	space	unit		CR	LF	

**Example:**

**SU CR LF** - command sent from a computer

**SU \_ A CR LF** - command understood and in progress

**SU \_\_\_\_\_ 1 7 2 . 1 3 5 \_ N \_ CR LF** - command carried out, response: mass value in current measuring unit.

where: \_ - space

**Immediately send measurement result in current measuring unit**

Format: **SUI CR LF**

Response options:

SUI\_I CR LF - command understood but not accessible at this moment

MASS FRAME - immediate response: mass value in basic measuring unit

Response format:

1	2	3	4	5	6	7-15	16	17	18	19	20	21
S	U	I	stability marker	space	character	mass	space	unit		CR	LF	

**Example:****S U I C R L F** - command sent from a computer**S U I ? \_ - \_ \_ \_ 5 8 . 2 3 7 \_ k g \_ C R L F** - command carried out, immediate response: mass value in current measuring unit.

where: \_ - space

**Switch on continuous transmission in basic measuring unit**Format: **C1 C R L F**

Response options:

**C1\_I C R L F** - command understood but not accessible at this moment**C1\_A C R L F** - command understood and in progress**MASS FRAME** - command carried out, immediate response: mass value in basic measuring unit

Response format:

1	2	3	4	5	6	7-15	16	17	18	19	20	21
S	I	space	stability marker	space	character	mass	space	unit			CR	LF

**Switch off continuous transmission in basic measuring unit**Format: **C0 C R L F**

Response options:

**C0\_I C R L F** - command understood but not accessible at this moment**C0\_A C R L F** - command understood and carried out**Switch on continuous transmission in current measuring unit**Format: **CU1 C R L F**

Response options:

**CU1\_I C R L F** - command understood but not accessible at this moment**CU1\_A C R L F** - command understood and in progress**MASS FRAME** - response: mass value in current measuring unit

Response format:

1	2	3	4	5	6	7-15	16	17	18	19	20	21
S	U	I	stability marker	space	character	mass	space	unit			CR	LF

**Switch off continuous transmission in current measuring unit**Format: **CU0 C R L F**

Response options:

**CU0\_I C R L F** - command understood but not accessible at this moment**CU0\_A C R L F** - command understood and carried out**Set min checkweighing threshold**Format: **DH\_XXXXX C R L F**, where: \_ - space, **XXXXX** - mass format

Response options:

**DH\_OK C R L F** - command carried out**ES C R L F** - command not recognised (mass format incorrect)

### Set max checkweighing threshold

Format: **UH\_XXXXX CR LF**, where: \_ - space, **XXXXX** - mass format

Response options:

UH\_OK CR LF - command carried out

ES CR LF - command not recognised (mass format incorrect)

### Give value of min checkweighing threshold

Format: **ODH CR LF**

Response: **DH\_MASS CR LF** - command carried out.

Response format:

1	2	3	4-12	13	14	15	16	17	18	19
D	H	space	mass	space	unit			space	CR	LF

**Mass** - 9 characters, right justification

**Unit** - 3 characters, left justification

### Give value of max checkweighing threshold

Format: **OUH CR LF**

Response: **UH\_MASS CR LF** - command carried out.

Response format:

1	2	3	4-12	13	14	15	16	17	18	19
U	H	space	mass	space	unit			space	CR	LF

**Mass** - 9 characters, right justification

**Unit** - 3 characters, left justification

### Set mass value of a single item (for PARTS COUNTING mode)

Format: **SM\_XXXXX CR LF**, where: \_ - space, **XXXXX** - mass format

Response options:

SM\_OK CR LF - command carried out

SM\_I CR LF - command understood but not accessible at this moment (e.g. mode other than PARTS COUNTING)

ES CR LF - command not recognised (mass format incorrect)

### Set target mass value (e.g. DOSING mode)

Format: **TV\_XXXXX CR LF**, where: \_ - space, **XXXXX** - mass format

Response options:

TV\_OK CR LF - command carried out

TV\_I CR LF - command understood but not accessible at this moment (e.g. mode other than DOSING)

ES CR LF - command not recognised (mass format incorrect)

### Set reference mass value (e.g. for PERCENT WEIGHING)

Format: **RM\_XXXXX CR LF**, where: \_ - space, **XXXXX** - mass format

Response options:

RM\_OK CR LF - command carried out

RM\_I CR LF - command understood but not accessible at this moment (e.g. mode other than PERCENT WEIGHING)

ES CR LF - command not recognised (mass format incorrect)

### **Value release**

Format: **SS CR LF**

Response options:

SS\_OK CR LF - command understood and in progress

Command's function is similar to function of PRINT key located on the instrument panel.

### **Internal adjustment**

Format: **IC CR LF**

Response options:

IC\_A CR LF - command understood and in progress

IC\_D CR LF - adjustment completed

IC\_A CR LF - command understood and in progress

IC\_E CR LF - time limit exceeded while waiting for stable measurement result

IC\_I CR LF - command understood but not accessible at this moment

### **Disable automatic internal adjustment of the module**

Format: **IC1 CR LF**

Response options:

IC1\_I CR LF - command understood but not accessible at this moment

IC1\_E CR LF - operation not possible, e.g. in case of verified module

IC1\_OK CR LF - command carried out

Operation not possible for verified balances.

For non-verified balances the command disables internal adjustment until it is enabled via IC0 command or until the balance is turned off. The command does not change module settings that concern factors determining adjustment process start.

### **Enable automatic internal adjustment of the module**

Format: **IC0 CR LF**

Response options:

IC0\_I CR LF - command understood but not accessible at this moment

IC0\_OK CR LF - command carried out

Operation not possible for verified balances.

### **Give balance serial number**

Format: **NB CR LF**

Response options:

NB\_A\_"x" CR LF - command understood, response: serial number

NB\_I CR LF - command understood but not accessible at this moment

x - module serial number, inserted in between inverted commas

Example:

Command: NB CR LF - give serial number

Response: NB\_A\_"1234567" - module serial number: "1234567"

### **Lock scale keypad**

Format: **K1 CR LF**

Response options:

K1\_I CR LF - command understood but not accessible at this moment

K1\_OK CR LF - command carried out

Command locks the balance keypad (proximity sensors, touch panel) until the moment of turning the balance off or until sending K0 command.

### Unlock scale keypad

Format: **K0 CR LF**

Response options:

K0\_I CR LF - command understood but not accessible at this moment

K0\_OK CR LF - command carried out

### Give available working modes

Command overview:

Command returns accessible working modes.

Format: **OMI <CR><LF>**

Response options:

OMI <CR><LF>

n\_ "Mode name" <CR><LF>

: - command carried out, response: accessible working modes

n\_ "Mode name" <CR><LF>

OK <CR><LF>

OMI\_I <CR><LF> - command understood but not accessible at this moment

**Mode name** – parameter, working mode name, inserted in between inverted comas. The name takes form given on a particular balance display, it is provided in a currently selected language.

**n** - parameter, decimal value determining working mode number.

n → 1 – Weighing

19 – Drying

#### CAUTION:

Working modes numbering is identical for each kind of weighing instrument. The numbers are assigned to working modes names.

Some balances give only the number as a response.

#### Example 1:

Command: OMI <CR><LF> - return accessible working modes

Response: OMI <CR><LF> - return accessible working modes,  
1\_ " Weighing" <CR><LF> mode number + name  
19\_ " Drying" <CR><LF>

OK <CR><LF> - command carried out

### Set working mode

Command overview:

Command sets particular working mode.

Format: **OMS\_n <CR><LF>**

Response options:

OMS\_OK <CR><LF> - command carried out

OMS\_E <CR><LF> - error in-course of command execution, no parameter or incorrect format

OMS\_I <CR><LF> - command understood but not accessible at this moment

**n** - decimal value determining working mode number. To see detailed description go to OMI command.

Example:

Command: OMS\_19 <CR><LF> - set DRYING mode

Response: OMS\_OK<CR><LF> - DRYING mode selected

### Give current working mode

Command overview:

Command returns accessible working modes.

Format: **OMG <CR><LF>**

Response options:

OMG\_n\_OK <CR><LF> - command carried out, response: current working mode

OMG\_I <CR><LF> - command understood but not accessible at this moment

**n** - decimal value determining working mode number. To see detailed description go to OMI command.

Example:

Command: OMG<CR><LF> - return current working mode

Response: OMG\_19 „Drying”\_OK<CR><LF> - balance set to STATISTICS mode

### Give accessible units

Command overview:

Command returns units available for a particular device and for a current working mode.

Format: **UI <CR><LF>**

Response options:

UI\_”x<sub>1</sub>,x<sub>2</sub>, ... x<sub>n</sub>”\_OK<CR><LF> - command carried out, returns accessible units

UI\_I <CR><LF> - command understood but not accessible at this moment

**x** - unit symbols, separated by means of commas

**x** → g, mg, ct, lb, oz, ozt, dwt, tlh, tls, tlt, tlc, mom, gr, ti, N, baht, tola, u1, u2

Example:

Command: UI <CR><LF> - return available units

Response: UI\_”g, mg, ct”\_OK<CR><LF> - response: available units

### Set current unit

Command overview:

Command sets current unit for a particular device.

Format: **US\_x <CR><LF>**

Response options:

US\_x\_OK <CR><LF> - command carried out, returns accessible units

US\_E <CR><LF> - error in-course of command execution, no parameter or incorrect format

US\_I <CR><LF> - command understood but not accessible at this moment

**x** - parameter, units symbols: g, mg, ct, lb, oz, ozt, dwt, tlh, tls, tlt, tlc, mom, gr, ti, N, baht, tola, msg, u1, u2, next.

**Caution:**

If x=next the command swaps to another available unit on the list (it simulates  button pressing, or taping unit field in mass window).

Example:

Command: US\_mg<CR><LF> - set „mg” unit

Response: US\_mg\_OK<CR><LF> - „mg” set as a current unit

## Give current unit

Command overview:

Command returns current unit.

Format: **UG <CR><LF>**

Response options:

**UG\_x\_OK<CR><LF>** - command carried out, returns accessible units

**UG\_I <CR><LF>** - command understood but not accessible at this moment

x - parameter, units symbols:

Example:

Command: UG<CR><LF> - return current unit

Response: UG\_ct\_OK<CR><LF> - currently set unit is „ct”

## Activate sound signal

Command overview:

Command activates BEEP sound signal for a specified amount of time.

Format: **BP\_TIME<CR><LF>**

Response options:

**BP\_OK<CR><LF>** - command carried out, BEEP activated

**BP\_E” <CR><LF>** - no parameter or incorrect format

**BP\_I <CR><LF>** - command understood but not accessible at this moment

**TIME** - parameter, decimal value specifying how long shall the sound last, parameter given in [ms]. Recommended range <50÷ 5000>.

If value greater than the permissible high limit is given, then BEEP sound is operated for the maximum permissible amount of time.

Example:

Command: BP\_350<CR><LF> - activate BEEP for 350 ms

Response: BP\_OK<CR><LF> - BEEP activated

### CAUTION:

BEEP sound activated via BP command is inhibited if in-course of its activation the sound is activated by means of other device: keypad, touch panel, proximity sensors.

## Send all implemented commands

Format: **PC CR LF**

Command: **PC CR LF** - send all implemented commands

Response: **PC\_A\_”Z,T,S,SI...”** - command carried out, the indicator sent all implemented commands.

## Give balance type

Format: **BN <CR><LF>**

Response options:

**BN\_A\_”x” <CR><LF>** - command understood, response: weighing device type

**BN\_I <CR><LF>** - command understood but not accessible at this moment

x - balance series (inserted in between inverted commas), with general balance type in front.

Example:

Command: BN <CR><LF> - Return scale type

Response: BN\_A\_”AS” - Scale type XA 4Y

### Give max capacity

Format: **FS <CR><LF>**

Response options:

FS\_A\_ "x" <CR><LF> - command understood, response: Max capacity

FS\_I <CR><LF> - command understood but not accessible at this moment

**x** - Max value of reading units (in between inverted commas)

Example:

Command: FS <CR><LF> - return Max capacity

Response: FS\_A\_ "220.0000" - Max capacity: "220 g"

### Give program version

Format: **RV <CR><LF>**

Response options:

RV\_A\_ "x" <CR><LF> - command understood, response: program version

RV\_I <CR><LF> - command understood but not accessible at this moment

**x** - program version (in between inverted commas)

Example:

Command: RV <CR><LF> - return program version

Response: RV\_A\_ " 1.1.1" - program version: "1.1.1"

### Set AUTOZERO Function

Format: **A\_n <CR><LF>**

Response options:

A\_OK <CR><LF> - command carried out

A\_E <CR><LF> - error in-course of command execution, no parameter or incorrect format

A\_I <CR><LF> - command understood but not accessible at this moment

**n** - parameter, decimal value determining autozero settings

n → 0 – autozero off

1 – autozero on

#### **CAUTION:**

Command changes settings for a current working mode.

Example:

Command: A\_1<CR><LF> - turn autozero function on

Response: A\_OK<CR><LF> - autozero function is on

AUTOZERO function operates until it is turned off by A 0 command.

### Set ambient conditions state

Format: **EV\_n <CR><LF>**

Response options:

EV\_OK <CR><LF> - command carried out

EV\_E <CR><LF> - error in-course of command execution, no parameter or incorrect format

EV\_I <CR><LF> - command understood but not accessible at this moment

**n** - parameter, decimal value determining ambient conditions state

n → 0 – unstable ambient conditions

1 – stable ambient conditions



**CAUTION:**

Command changes settings for a current working mode.

Example:

Command: EV\_1<CR><LF> - set value 'stable' for ambient conditions option  
 Response: EV\_OK<CR><LF> - set value 'stable' for ambient conditions option  
 <AMBIENT CONDITIONS> parameter is set to value <STABLE> until command EV 0 swaps it to value <UNSTABLE>.

### Give set ambient conditions state

Command overview:

Command gives information about state of currently set ambient conditions.

Format: **EVG <CR><LF>**

Response options:

**EVG\_x\_OK<CR><LF>** - command carried out, response: set ambient conditions state

**EVG\_I <CR><LF>** - command understood but not accessible at this moment

x - parameter, ambient conditions symbols

Example:

Command: EVG<CR><LF> - give current ambient conditions state  
 Response: EVG\_0\_OK<CR><LF> - current ambient conditions state: unstable

### Set filter

Format: **FIS\_n <CR><LF>**

Response options:

**FIS\_OK<CR><LF>** - command carried out

**FIS\_E <CR><LF>** - error in-course of command execution, no parameter or incorrect format

**FIS\_I <CR><LF>** - command understood but not accessible at this moment

n - parameter, decimal value determining filter number.

n → 1 – very fast

2 – fast

3 – average

4 – slow

5 – very slow

**CAUTION:**

The numbering is assigned to a particular filter name and it is identical for all balance types. The command changes settings for a current working mode if, for a particular balance type, filter settings are assigned to the working mode.

Example:

Command: FIS\_3<CR><LF> - set average filter  
 Response: FIS\_OK<CR><LF> - average filter set

### Give current filter setting

Command overview:

Command gives information about currently set filter.

Format: **FIG <CR><LF>**

Response options:

**FIG\_x\_OK<CR><LF>** - command carried out, response: currently set filter

**FIG\_I <CR><LF>** - command understood but not accessible at this moment

**x** - parameter, symbol of currently set filter

Example:

Command: FIG<CR><LF> - give current filter

Response: FIG\_2\_OK<CR><LF> - currently set filter: average

### Set value release

Format: **ARS\_n <CR><LF>**

Response options:

ARS\_OK <CR><LF> - command carried out

ARS\_E <CR><LF> - error in-course of command execution, no parameter or incorrect format

ARS\_I <CR><LF> - command understood but not accessible at this moment

**n** - parameter, decimal value determining value release options

n → 1 – fast

2 – fast + reliable

3 – reliable

### CAUTION:

The numbering is assigned to a particular value release option and it is identical for all balance types.

If for a particular balance type, last digit settings are assigned to a working mode, the command changes the current mode's settings.

Example:

Command: ARS\_2<CR><LF> - set value release parameter to fast+reliable option

Response: ARS\_OK<CR><LF> - fast+reliable option set

### Give current value release setting

Command overview:

Command gives information about current value release setting.

Format: **ARG <CR><LF>**

Response options:

**ARG\_x\_OK<CR><LF>** - command carried out, response: current value release setting

**ARG\_I <CR><LF>** - command understood but not accessible at this moment

**x** - parameter, symbol of current value release setting

Example:

Command: ARG<CR><LF> - give current value release setting

Response: ARG\_2\_OK<CR><LF> - current value release setting: fast+reliable

### Set last digit

Format: **LDS\_n <CR><LF>**

Response options:

LDS\_OK <CR><LF> - command carried out

LDS\_E <CR><LF> - error in-course of command execution, no parameter or incorrect format

LDS\_I <CR><LF> - command understood but not accessible at this moment

**n** - parameter, decimal value determining last digit settings

n → 1 – always  
2 – never  
3 – when stable

**CAUTION:**

The numbering is assigned to a particular last digit option and it is identical for all balance types.

If for a particular balance type, last digit settings are assigned to a working mode, the command changes the current mode's settings.

Example:

Command: LDS\_1<CR><LF> - set last digit option to value 'always'

Response: LDS\_OK<CR><LF> - 'always' value set

**Operator logging**

Format: **LOGIN\_Name, Password CR LF**

where: \_ - space (enter name and password in a form provided by the balance – *lower-case letters and upper-case letters*).

Response options:

LOGIN OK CR LF - command understood, new operator logged in

LOGIN ERROR CR LF - command understood, an error in name or password occurred, log in failed

ES CR LF - command not recognized (error in format)

**Operator logout**

Format: **LOGOUT CR LF**

Response options:

LOGOUT OK CR LF - command understood, user is logged out

ES CR LF - command not recognized (error in format)

**Give set profile name**

Format: **PRG CR LF**

Response options:

PRG\_A\_”x” CR LF - command understood, response: profile name

PRG\_I CR LF - command understood but not accessible at this moment

**x** - profile name (in between inverted commas)

Example:

Command: **PRG CR LF** - give profile name

Response: **PRG\_A\_”Fast”** – profile name —”Fast”

**Profile selection**

Format: **PROFILE\_Name CR LF**

where: \_ - space (enter name in a form provided by the balance – *lower-case letters and upper-case letters, spaces; e.g. Fast; Fast dosing, User, Precision*).

Response options:

PROFILE OK CR LF - command understood, new profile set

LOGIN ERROR CR LF - command understood, an error in name, profile setting impossible

ES CR LF - command not recognized (error in format)

**Give accessible units**

Command overview:

Command returns units available for a particular device and for a current working mode.

Format: **UI <CR><LF>**

Response options:

**UI\_”x<sub>1</sub>,x<sub>2</sub>, ... x<sub>n</sub>”\_OK<CR><LF>** - command carried out, returns accessible units

**UI\_I <CR><LF>** - command understood but not accessible at this moment

**X** - unit symbols, separated by means of commas

**x** → g, mg, ct, lb, oz, ozt, dwt, tlh, tls, tlt, tlc, mom, gr, ti, N, baht, tola, u1, u2

Example:

Command: UI <CR><LF> - return available units

Response: UI\_”g, mg, ct”\_OK<CR><LF> - response: available units

### Set current unit

Command overview:

Command sets current unit for a particular device.

Format: **US\_x <CR><LF>**

Response options:

**US\_x\_OK <CR><LF>** - command carried out, returns accessible units

**US\_E <CR><LF>** - error in-course of command execution, no parameter or incorrect format

**US\_I <CR><LF>** - command understood but not accessible at this moment

**x** - parameter, units symbols: g, mg, ct, lb, oz, ozt, dwt, tlh, tls, tlt, tlc, mom, gr, ti, N, baht, tola, msg, u1, u2, next

#### CAUTION:

If x=next the command swaps to another available unit on the list (it simulates button pressing).

Example:

Command: US\_mg<CR><LF> - set „mg” unit

Response: US\_mg\_OK<CR><LF> - „mg” set as a current unit

### Give current unit

Command overview:

Command returns current unit.

Format: **UG <CR><LF>**

Response options:

**UG\_x\_OK<CR><LF>** - command carried out, returns accessible units

**UG\_I <CR><LF>** - command understood but not accessible at this moment

**x** - parameter, units symbols:

Example:

Command: UG<CR><LF> - return current unit

Response: UG\_ct\_OK<CR><LF> - currently set unit is „ct”

Integration with PUE 7.1, PUE 10 indicator

Format: **NT CR LF**

Response options:

ES CR LF - command not recognised (mass format incorrect)

MASS FRAME - command carried out, immediate response: mass value in basic measuring unit

Response format:

1	2	3	4	5	6	7	8	9-18	19	20-22	23	24-32	33	34-36	37	38	39	40
N	T	Space	Stability marker	Zero marker	Range marker	Digit marker	Space	Mass	Space	Mass unit	Space	Tare	Space	Tare unit	Space	Hidden digits quantity	CR	LF

**NT** - Command

**Stability marker** - [space] if stable, [?] if unstable

**Zero marker** - [space] for any value but zero, [Z] for zero value

**Range marker** - marker informing on range within which mass value is comprised: [space] I range balance, [2] II balance, [3] III balance

**Digit marker** - [zero] no digit, [1] one digit marker, [2] two digits marker, [3] three digits marker, [4] four digits marker, [5] five digits marker

**Mass** - 10 characters for net mass given in adjustment unit (with dot and a floating-point "-" sign ) with right justification

**Mass unit** - 3 characters, left justification

**Tare** - 9 characters with dot - right justification (when floating-point tare gets turned off automatically then zero value is sent)

**Tare unit** - 3 characters, left justification

**Hidden digits quantity** - number specifying quantity of hidden digits: [space] when no digits are hidden, [1] when 1 digit is hidden

**Example:**

**NT CR LF** - command sent from a computer

**NT \_ ? \_ \_ 0 \_ \_ \_ \_ \_ - 5 . 1 1 3 \_ g \_ \_ \_ \_ \_ \_ 0 . 0 0 0 \_ g \_ \_ \_ 0 CR LF**

- command carried out, response: mass value and remaining data

where: \_ - space

### 27.3. Manual Printout / Automatic Printout

It is possible to generate printouts either manually or automatically.

- Manual printout: upon indication stabilization press  key.
- Automatic printout is generated automatically in accordance with the settings for automatic printout (*read section 15.5 of this User Manual*).

The content of a printout depends on settings of <Standard printout> menu - <Weighing printout template> (*read section 15.5 of this User Manual*).

#### Mass printout format:

1	2	3	4 -12	13	14	15	16	17	18
stability marker	space	stability	mass	space	unit			CR	LF

Stability marker	[space] if stable [?] if unstable [!] if air buoyancy compensation mode is enabled [^] if high limit is out of range [v] if low limit is out of range
Character	[space] for positive values [-] for negative values
Mass	9 characters with decimal point, right justification
Unit	3 characters, left justification

#### Example:

\_\_\_\_ \_ **1 8 3 2 . 0 \_ g \_ \_ CR LF** - a printout generated, with reference to <Weighing printout template> settings, from a weighing device upon pressing  key:

N (measurements quantity)	<b>NO</b>	Universal variable 1 ... 5	<b>NO</b>
Date	<b>NO</b>	Net	<b>NO</b>
Time	<b>NO</b>	Tare	<b>NO</b>
Level status	<b>NO</b>	Gross	<b>NO</b>
Customer	<b>NO</b>	Current result	<b>NO</b>
Warehouse	<b>NO</b>	Additional unit	<b>NO</b>
Product	<b>NO</b>	Mass	<b>YES</b>
Packaging	<b>NO</b>	Non-standard printout	<b>NO</b>

## 28. CONNECTING PERIPHERAL DEVICES

The following peripheral devices can be connected to the moisture analyzer:

- computer,
- receipt printer: KAFKA, EPSON,
- PCL printer,
- additional display,
- barcode scanner,
- an optional peripheral device operating ASCII communication protocol.

## 29. ERROR MESSAGES



Max weighing threshold exceeded  
Unload the weighing pan



Min weighing threshold exceeded  
Install weighing pan



Zeroing out of range  
Press tarring button or restart the balance



Display capacity out of range  
Unload the weighing pan



Tarring out of range  
Press zeroing button or restart the balance



Start mass out of range  
Install weighing pan



Zeroing/tarring time out of range  
Weighing indication unstable

-no level-      Balance not levelled

-Err 100-      Weighing module restart

In process      In-course process resulting in unstable measurement (automatic feeder – pills feeding process or comparator – load change process)

### 30. ADDITIONAL EQUIPMENT

Type	Name
P0151	RS232 cable for EPSON printer
EPSON	Dot matrix printer
	PCL printer
CK-01	Transponder card scanner
LS2208	Barcode scanner
AP2-1	Power loop output
SAL	Anti-vibration table for AS and PS series balances
	PC keyboard – USB type

**Computer software:**

- PW-WIN,
- RAD-KEY.
- E2R-MOISTURE ANALYZER

### 31. APPENDIX A - Printout Variables

#### 31.1. Variables List

**CAUTION:**

*Each defined variable must be inserted in between curly bracket: {x}, where x – variable number.*

List of variables defining non-standard printout templates and data displayed within the workspace:

Symbol	Description
{0} <sup>1)</sup>	Standard printout in an adjustment unit
{1} <sup>1)</sup>	Standard printout in a current unit
{2}	Date
{3}	Time
{4}	Date and time
{5}	Working mode
{6}	Net weight in a current unit
{7}	Net weight in adjustment unit
{8}	Gross weight
{9}	Tare
{10}	Current unit
{11}	Adjustment unit
{12}	Min threshold



{13}	Max threshold
{15}	Statistics: Number
{16}	Statistics: Sum
{17}	Statistics: Average
{18}	Statistics: Minimum
{19}	Statistics: Max
{20}	Statistics: SDV
{21}	Statistics: D
{22}	Statistics: RDV
{26}	Result control
{27}	Value
{28}	Level status
{30}	Gross value
{31}	Platform number
{32}	Serial number
{33}	Reading unit
{34}	Range
{35}	Parts counting: Reference sample mass
{36}	Percent weighing: Reference mass
{38}	Universal variable: Name
{39}	Universal variable: Value
{43}	Net weight in a supplementary unit
{44}	Additional unit
{45}	Target value
{46}	Tolerance
{47}	Difference
{48}	Balance type
{50}	Product: Name
{51}	Product: Code
{52}	Product: EAN code
{53}	Product: Mass
{54}	Product: Tare

{55}	Product: Price
{56}	Product: Minimum
{57}	Product: Maximum
{59}	Product: Shelf-life time in days
{60}	Product: VAT
{61}	Product: Date
{62}	Product: Expiry date
{63}	Product: Density
{64}	Product: Ingredients
{65}	Product: Description
{66}	Product: Tolerance
{75}	Operator: Name
{76}	Operator: Code
{77}	Operator: Permissions
{80}	Packaging: Name
{81}	Packaging: Code
{82}	Packaging: Mass
{85}	Customer: Name
{86}	Customer: Code
{87}	Customer: TIN
{88}	Customer: Address
{89}	Customer: Postal code
{90}	Customer: City
{91}	Customer: Discount
{130}	Warehouse: Name
{131}	Warehouse: Code
{132}	Warehouse: Description
{140}	Additional Display
{141}	Additional display: WD
{142}	Additional display: WWG
{143}	Hex
{144}	Hex UTF-8

{146}	Gross weight value in current unit
{147}	Tare in current unit
{150}	PCL printer: Form feed
{151}	Epson printer: Paper cut
{210}	Adjustment history: Adjustment type
{211}	Adjustment history: Nominal mass
{212}	Adjustment history: Current mass
{213}	Adjustment history: Difference
{214}	Adjustment history: Temperature
{215}	Adjustment history: Level status
{216}	Adjustment history: Platform number
{275}	Ambient conditions report: Date and time
{276}	Ambient conditions report: THB temperature
{277}	Ambient conditions report: THB humidity
{278}	Ambient conditions report: Temperature 1
{279}	Ambient conditions report: Temperature 2
{280}	Ambient conditions report: THB pressure
{281}	Ambient conditions report: Air density
{282}	Ambient conditions report: Humidity
{283}	Ambient conditions report: Pressure
{380}	Drying program: Name
{381}	Drying program: Code
{385}	Drying profile
{386}	Drying profile parameters
{387}	Finish mode
{388}	Finish mode parameters
{389}	Drying report: Unit
{390}	Drying report: Printout interval
{395}	Moisture analyzer: Set temperature
{396}	Moisture analyzer: Current temperature

{397}	Moisture analyzer: Drying time
{398}	Moisture analyzer: Status
{399}	Moisture analyzer: Drying time and result
{400}	Moisture analyzer: Humidity content
{401}	Moisture analyzer: Dry content
{402}	Moisture analyzer: Humid/Dry ratio
{403}	Moisture analyzer: Heating source test – Power [%]

**CAUTION:**

- 1) Format of variables {0} and {1} is finished with **CR LF** characters (i.e. switching to a next line is carried out automatically),

### 31.2. Variables Formatting

You can format numeric, text and data variables to be printed or to be displayed in the workspace.

**Formatting types:**

- variables with left justification,
- variables with right justification,
- determining quantity of characters for printing / displaying,
- determining quantity of decimal places for numeric variables,
- converting the format of date and hour,
- converting numeric variables into EAN13 code,
- converting numeric variables and date into EAN128 code.

**Special formatting characters:**

Character	Description	Example
,	Sign separating variable from format item.	<b>{7,10}</b> - Net weight in adjustment unit with constant length of 10 characters, with right justification
-	Minus sign or left justification	<b>{7,-10}</b> - Net mass in adjustment unit with constant length of 10 characters, with left justification
:	Sign proceeding formatting or time separator (i.e. hours, minutes and seconds)	<b>{7:0.000}</b> - Net mass in adjustment unit always with three decimal places; <b>{3:hh:mm:ss}</b> – Current time in format: hour : minute : second.
.	First detected dot in a digit is recognized as separator of integer and decimal parts. Each following dot is ignored.	<b>{55:0.00}</b> - Product's unit price always with two decimal places; <b>{17:0.0000}</b> – Measurements average, always with four decimal places;
<b>F</b>	Sign formatting digits to a chain of sign in format “-ddd.ddd...” (where: d - single digit, minus - for negative values only) or determination of decimal places quantity.	<b>{7:F2}</b> - Net mass in adjustment unit always with two decimal places; <b>{7,9:F2}</b> - Net mass in adjustment unit always with two decimal places and fixed length of 9 characters with right justification;
<b>V</b>	Formatting mass and quantities derivatives of mass in EAN13 code	<b>{7:V6.3}</b> - Net mass in a form of EAN13 code (6-character code) with three decimal places

Character	Description	Example
T	Formatting mass and quantities derivatives of mass in EAN128 code	{7:T6.3} - Net mass in a form of EAN128 code with three decimal places;
/	Date separator separating days, months and years.	{2:yy/MM/dd} - Current date in format: year - month - day, where yy stand for two less meaningful characters of a year;
\	Sign "escape" deleting a formatting function from the following sign, so that it is recognized as text	{2:yy\MM\dd} – Current date in format: year / month / day. {2:yy\:\MM\:\dd} - Current date in format: year : month : day. Should „\” be used in literal meaning, insert \\;

#### Formatted variables application:

CODE	Description
{7:V6.3}	Net mass in EAN 13 code (6-character code)
{7:V7.3}	Net mass in EAN 13 code (7-character code)
{27:V6.3}	Net value in EAN 13 code (6-character code)
{27:V7.3}	Net value in EAN 13 code (7-character code)
{7:T6.3}	Net mass in EAN 128 code
{8:T6.3}	Gross mass in EAN 128 code
{55:T6.2}	Product price in EAN 128 code
{2:YYMMDD}	Date in EAN 128 code
{61:yyMMdd}	Product date in EAN 128 code
{62:YYMMDD}	Product expiry date in EAN 18 code

## 32. APPENDIX E - ZEBRA Printer Settings

Baud rate – 9600 b/sec  
Parity control – none  
Bits qty – 8 bits  
Stop bits – 1 bit

It is possible to generate printouts either manually or automatically.

Serial port : **96, N, 8, 1**

For detailed procedure specifying how to print info printout and how to modify printer settings read user manual of ZEBRA printers.

### 33. APPENDIX E - Communication with Barcode Scanner

1. For communication with barcode scanners, RADWAG moisture analyzers use RS232 interfaces and simplex transmission (one-way direction), without handshaking. For this purpose, use of second line of the cable is sufficient. Transmission parameters can be set for both weighing devices and scanners.
2. Transmission parameters can be set for both weighing devices and scanners. For both devices the following parameters must comply: baud rate, data bits quantity, parity control, stop bits quantity; e.g. 9600,8,N,1 – baud rate 9600 bit/s, data 8-bits, no parity control, 1 stop bit.
3. Barcode scanners can send additional information apart from the expected barcode e.g. symbology (type of barcode). Due to the fact that RADWAG devices and software do not use such information, it is advisable to disable it.
4. Some RADWAG systems can omit unnecessary coded information by using parameters that mark the beginning and the length of the code subjected to analysis.
5. A special protocol is required in order the code be received by RADWAG equipment. It is required to program an appropriate *prefix* and *suffix*. In RADWAG-adopted standard, the prefix is 01 sign (byte) hexadecimal format, the suffix is 0D sign (byte) hexadecimal format.
6. Most barcode scanners allow to enable/disable different symbologies (barcode types).
7. Programming of scanners is performed by reading special barcodes.

Barcode with required prefix and suffix in hexadecimal format	Barcode without required –fixes in ASCII format	Code type
01 30 30 32 31 30 31 32 36 0D	00210126	EAN-8
01 30 31 32 33 34 35 36 37 38 39 0D	0123456789	CODE 2 OF 5
01 43 4F 44 45 20 33 39 20 54 45 53 54 0D	CODE 39 TEST	CODE 39
01 31 31 30 31 32 33 34 35 36 37 38 39 31 0D	1101234567891	EAN-13
01 43 6F 64 65 20 31 32 38 20 54 65 73 74 0D	CODE 128 Test	CODE 128

## 34. APPENDIX G – Menu Structure

### User Adjustment

Description	Value
External Adjustment	Function
User Adjustment	Function
Adjustment test	Function
Report Printout	No / Yes
GLP Project. . →→	

Name	Option
» Adjustment	No / Yes
» Working mode	No / Yes
» Date	No / Yes
» Time	No / Yes
» Operator	No / Yes
» Balance type	No / Yes
» Balance S/N	No / Yes
» Level status	No / Yes
» Nominal mass	No / Yes
» Difference	No / Yes
» Temperature	No / Yes
» Current mass	No / Yes
» Empty line	No / Yes
» Dashes	No / Yes
» Signature	No / Yes
» Non-standard printout	No / Yes
Adjustment History	Displays a report on completed external adjustments

### DATABASES

- Products
- Weighing records
- Customers
- Drying programs
- Drying reports
- Ambient conditions
- Packaging
- Warehouses
- Printouts
- Universal variables
- Delete data older than
- Export weighing database to a file

## Communication

Description	Value
COM 1	-
» Baud rate	9600
» Data bits	8
» Stop bits	1
» Parity	None
COM 2	-
» Baud rate	9600
» Data bits	8
» Stop bits	1
» Parity	None
Ethernet	-
» DHCP	No
» IP address	192.168.0.2
» Subnet mask	255.255.255.0
» Default gateway	192.168.0.1
Tcp	-
Port	4001

## Peripherals

Description	Value
Computer	-
» Port	COM 1
» Address	1
» Continuous Transmission	No / Yes
» Printout template	Setting
» E2R SYSTEM	Setting
Printer	
» Port	COM 2
» Code page	1250
» Printouts	Setting
Barcode scanner	
» Port	None / COM 1/ COM 2
» Offset	0
» Length of code	0



Transponder card scanner		
	Port	None / COM 1/ COM 2
Additional display		
	Port	None / COM 1-2 / Tcp
	Project	Setting
Ambient conditions module		
	Port	None / COM 1-2 / Com internal
	Address	3

## Inputs / outputs

Description	Value
Inputs	
» Input 1	Option
» Input 2	Option
» Input 3	Option
» Input 4	Option
Outputs	
» Output 1	Option
» Output 2	Option
» Output 3	Option
» Output 4	Option

## Permissions

Description	Value
Anonymous operator	
» Guest	Option
» Operator	Option
» Advanced operator	Option
» Administrator	Option
Date and time	
» Guest	Option
» Operator	Option
» Advanced operator	Option
» Administrator	Option
Printouts	
» Guest	Option

» Operator	Option
» Advanced operator	Option
» Administrator	Option
<b>Databases</b>	
Products	Option: - Guest - Operator - Advanced operator - Administrator
Customers	
Formulations	
Packaging	
Warehouses	
Printouts	
Delete data older than	

### Miscellaneous

Description	Value
Language	Option
Date and time	Setting
Beep	Option
Touch panel calibration	Function
Level control	Option
Autotest	Option

## 35. APPENDIX H – Address of PMV 50 Moisture Analyzer Manufacturer

RADWAG - Radom headquarters  
 Toruńska 5, 26-600 Radom  
 Phone: +48 (48) 386 60 00,  
 Service: +48 (48) 386 64 16,  
 Fax: +48 (48) 385 00 10  
 radom@radwag.pl  
 radwag.com

*User manual number:  
 IMMU-98-02-05-19-EN*





**RADWAG BALANCES AND SCALES**  
ADVANCED WEIGHING TECHNOLOGIES

