

GC SERIES

Counting Scale

INSTRUCTION MANUAL

GC-3K
GC-6K
GC-15K
GC-30K





A&D Company, Ltd.



Note for Precautions

To prevent accidents due to inappropriate handling, this manual contains the following warning signs and marks. The meanings of these warning signs and marks are as follows.

Warning Definitions

 DANGER	An imminently hazardous situation that could result in death or serious injury, if not avoided.
 WARNING	A potentially hazardous situation that could result in death or serious injury, if not avoided.
 CAUTION	A potentially hazardous situation which, if not avoided, may result in personal injury or property damage.

Symbols Definitions

	△ indicates caution (including warning). A symbol inside the figure shows a specific content (in the case of the left figure, it is about electrical shock).
	⊘ indicates prohibition. Specific content is shown in ⊘ or in terms and illustration near ⊘. In the case of the left figure, it is about “prohibition of disassembly”.
	● indicates something that must be followed. Specific content is shown in ● or in terms and illustration near ●. In the case of the left figure, it is about “something that must be followed”.

Other

NOTE	The information that is helpful in using the device
-------------	---

Caution

- (1) No parts of this manual may be reproduced without permission. This manual may not be copied, modified, or translated without the written permission of A&D Company, Limited (hereinafter referred to as A&D). No parts or all of the contents in this manual may be reproduced without permission.
- (2) The contents of this manual are subject to change without notice.
- (3) Please contact A&D if you notice any uncertainty, errors, omissions, etc. in this manual.
- (4) A&D bears no liability for direct, indirect, special, or consequential damages due to the operation of this product, the claim of rights by third party, or for data loss, even if advised of the possibility of such damage regardless of (3) above.

© 2022 A&D Company, Limited

This manual may be reproduced or revised without permission of A&D. Product names and company names mentioned in this manual are trademarks or registered trademarks of their respective companies in Japan or other countries and regions.



Contents

1. COMPLIANCE	5
1.1. Compliance with FCC Rules	5
2. INTRODUCTION	5
3. OVERVIEW	5
4. PRECAUTIONS FOR USE.....	6
4.1. Precautions When Installing the Scale	6
4.2. Precautions When Weighing	6
4.3. Precautions for Storing	6
5. UNPACKING	7
6. PART NAMES	8
7. INSTALLATION	10
8. BASIC OPERATION.....	12
8.1. Basic Operation of the Scale	12
8.2. Tare Subtraction	13
8.2.1. Set by Weighing a Tare.....	13
8.2.2. Input a Tare Weight with the Keyboard.....	13
8.2.3. Clear a Tare Weight	14
9. COUNTING.....	15
9.1. Prepare to Start Counting	15
9.2. Back Up the Unit Weight.....	16
9.3. Key Restriction Function	16
9.4. Unit Weight by Sample	17
9.5. Unit Weight by Keyboard	19
9.6. Unit Weight by ID Number	20
9.6.1. Search by ID Number.....	21
9.6.2. Search by Item Code	22
9.6.3. AIS Function.....	24
10. STORE UNIT WEIGHT	26
10.1. Storing Unit Weight.....	26
10.2. Clearing a Stored Unit Weight	28
10.3. Call Up Unit Weight Together with Tare Weight.....	29
10.4. Call Up Unit Weight Together with Comparator Upper Limit Value and Lower Limit Value.....	29
10.5. Call Up Unit Weight Together with Comparator Upper Limit Value, Lower Limit Value, and Tare Weight.....	29
11. TOTAL (M+) FUNCTION.....	30
11.1. Total (M+) Function.....	30
11.2. Viewing the Total Count.....	31
11.3. Clearing the Total Count.....	31
11.4. Subtraction (M-) Function	31
11.5. Calling Up Unit Weight and Total Count Together	31
12. COMPARATOR FUNCTION	32
12.1. Setting the Comparator.....	32
12.2. Comparison Relation	33
12.3. Setting Upper Limits and Lower Limits	33

13. SENSITIVITY ADJUSTMENT	34
13.1. Preparing for Sensitivity Adjustment.....	34
13.2. Sensitivity Adjustment Using a Weight	35
13.3. Correcting Gravity Acceleration	36
13.4. Initializing Sensitivity Adjustment Value	36
14. FUNCTIONS.....	37
14.1. Function Setting	37
14.2. Function List.....	38
14.3. Password Lock Function.....	45
14.3.1. Password Registration	45
14.3.2. Function Setting after Password Lock	46
14.3.3. If You Forget Your Password	47
14.4. Initialization of Function Settings	47
15. ACAI	48
15.1. ACAI Function.....	48
15.2. Automatic Operation of ACAI.....	48
15.3. Manual Operation of ACAI.....	49
16. COMMUNICATION SPECIFICATIONS	50
16.1. RS-232C Interface	50
16.2. Communication Mode	51
16.3. Commands.....	55
16.4. UFC (Universal Flex Coms) Function	62
17. SD.....	65
17.1. Usable Type of SD Card	65
17.2. Data Format	65
17.3. Inserting SD Card	67
17.4. Copying Data	68
18. OPTIONS.....	69
18.1. Options List.....	69
18.2. AD-8561	69
18.2.1. Input With Barcode Reader/Keyboard	69
18.2.2. Comparator Relay Output	69
18.2.3. Interface for Remote Scale	70
18.3. Separation of Display/GC-08	72
18.3.1. Separation of Display	72
18.3.2. Attachment of GC-08	72
19. MAINTENANCE	73
19.1. Repair	73
19.2. Troubleshooting	73
19.3. Error Display	73
20. SPECIFICATIONS.....	75
20.1. Specifications List	75
20.2. External Dimensions.....	76
20.3. Gravity Acceleration Map.....	77



1. Compliance

1.1. Compliance with FCC Rules

Please note that this equipment generates, uses and can radiate radio frequency energy. This equipment has been tested and has been found to comply with the limits of Class A digital devices pursuant to Part 15 of FCC rules. These rules are designed to provide reasonable protection against interference when equipment is operated in a commercial environment. If this unit is operated in a residential area, it may cause some interference and under these circumstances the user would be required to take, at his own expense, whatever measures are necessary to eliminate the interference. (FCC = Federal Communications Commission in the U.S.A.)



2. Introduction

Thank you for purchasing a GC series counting scale. This manual describes how the GC series counting scale works. For effective use, read this instruction manual thoroughly before using the product.



3. Overview

This product has the following characteristics.

- Counting scales with display resolution 1/6000 to 1/7500.
- When counting the number of pieces that have the same weight, the number can be calculated from the weight (unit weight) of one piece.
- Unit weight can be set in various ways as follows.
 - Weigh the total weight of samples for which quantity is specified such as five, ten, etc.
 - Weigh the total weight of samples for which quantity is arbitrary.
 - Input a known unit weight with a keyboard.
 - Call up the unit weight that is stored in internal memory or external memory (micro SD card).
 - Set externally such as with a computer.
- Unit weight can be easily set according to the status of LED blinking.
- With ACAI (Automatic Counting Accuracy Improvement), counting with accurate unit weight is possible.
- In internal memory, unit weight up to 1000, item code, tare weight, total count, and comparator upper and lower limits can be stored together with the ID.
- For the item code, upper-case/lower-case alphabet and numeric digits are usable.
- The M+ function adds the counting results.
- The comparator function compares upper and lower limits that have been set with the counted value or weighed value. The result is shown as LO, OK, and HI (red, green, and yellow).
- The display can be separated from the main scale.
- For the power, an AC adapter or commercial mobile battery is usable.
- With the RS-232C cable or AD-8561 (Multi-Interface), weighing data and counting data can be sent to a computer.



4. Precautions for Use

4.1. Precautions When Installing the Scale

DANGER

- Do not touch the AC adaptor with wet hands. Doing so may cause electric shock.
- Do not install the scale in a location where corrosive gas or flammable gas are present.

WARNING

- Do not apply excessive load to the cable.
- The scale is heavy. Use caution when lifting, moving and carrying the scale. Do not lift the scale by holding the display unit or weighing pan. Doing so may cause the product to fall and be damaged. Hold the bottom side of the base unit when lifting, moving and carrying the scale.
- Use the scale indoors. If used outdoors, the scale may be subjected to lightning surges that exceed the discharge capacity. It may not be able to withstand the energy of the lightning and may be damaged.

Consider the following installation conditions in order to obtain the proper performance.

- The ideal conditions for installation are stable temperature and humidity, solid and level surface, location with no draft or vibration, indoors out of direct sunlight and a stable power supply.
- Do not install the scale on a soft floor or where there is vibration.
- Do not install the scale in location where breezes or large fluctuations in temperature occur.
- Avoid locations in direct sunlight.
- Do not install in a location with strong magnetic fields or strong radio signals.
- Do not install the scale in a location where static electricity is likely to occur. When humidity is 45% R.H. or less, plastic and insulating materials are susceptible to being charged with static electricity due to friction, etc.
- The scale is not dustproof or waterproof. Install the scale in a location where it will not become wet.
- When the AC adapter is connected to an unstable AC power supply, it may malfunction.
- Turn on the scale using the **ON/OFF** key and keep the weighing display on for at least 30 minutes before use.

4.2. Precautions When Weighing

- Do not place a load exceeding the weighing capacity on the weighing pan.
- Do not apply shock to or drop anything on the weighing pan.
- Do not use a sharp instrument such as a pen to press switches.
- Press the **ZERO** key before each weighing to reduce weighing errors.
- Periodically confirm that weighing values are correct.

4.3. Precautions for Storing

- Do not disassemble the scale.
- Wipe using a soft cloth slightly moistened with a mild detergent when cleaning the scale. Do not use organic solvents. Using organic solvents such as MEK may cause the display to become so opaque that it cannot be properly seen.
- Prevent water, dust and other foreign materials from getting into the scale.
- Do not scrub with a brush or the like.



5. Unpacking

The following items are included in the package.

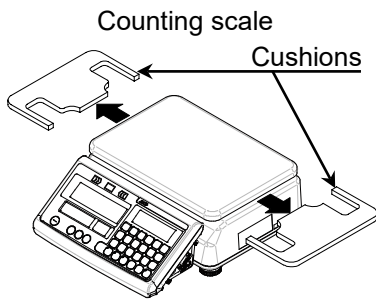

Quick start guide



AC adapter

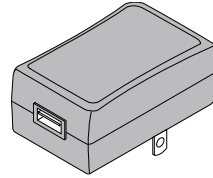

USB cable (A to C)
Approximately 1.5m

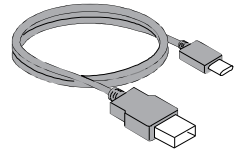

- Remove the cushions under the weighing pan
(Put the cushions back under the weighing pan when transporting the scale to another place).



6. Part Names

Weighing pan

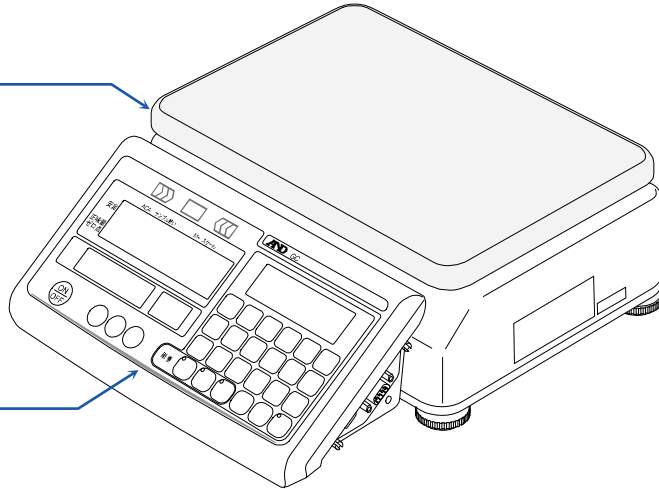

Front panel (Refer to the next page)

Power panel

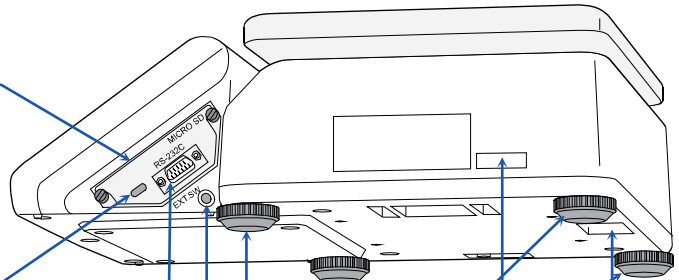

Power input terminal

RS-232C terminal

External input terminal

Leveling feet (Turn so the bubble in the bubble spirit level is in the center.)

Serial number

Grounding terminal

Bubble spirit level



The scale is horizontal.



The scale is tilted.



Weighing will be correct



Weighing will not be correct

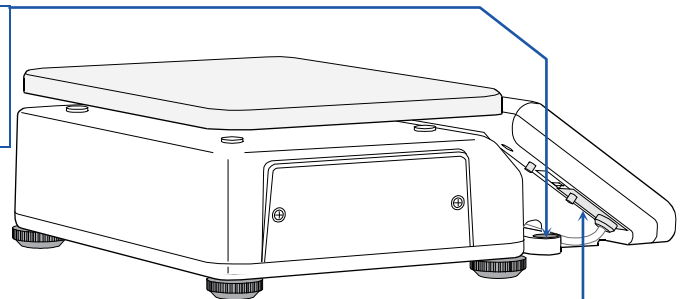

Cable panel

Front Panel

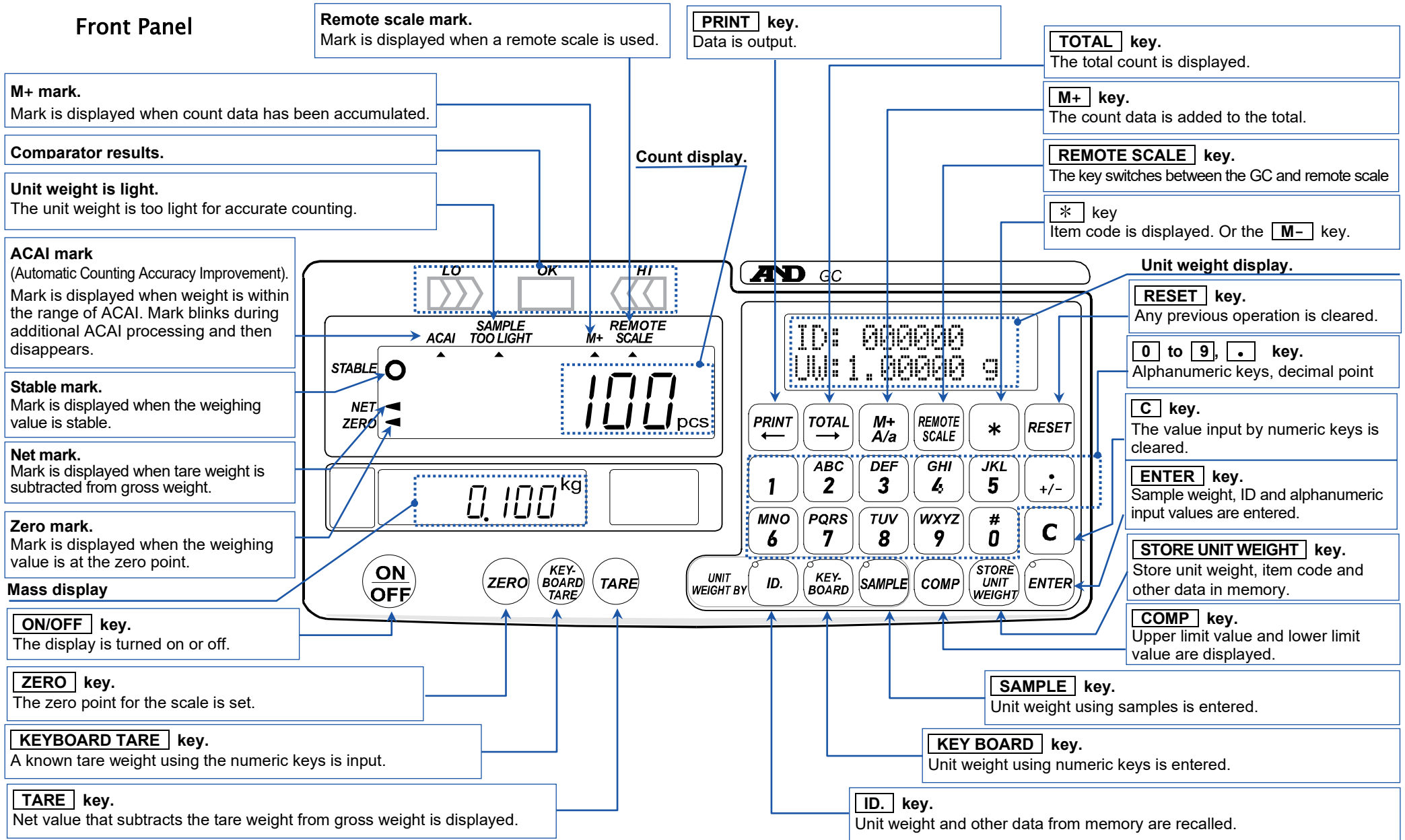



7. Installation

- Adjust the horizontal level of the product using the four leveling feet and bubble spirit level. Confirm that the scale is seated firmly and does not rattle (refer to “4.1. Precautions When Installing the Scale”).

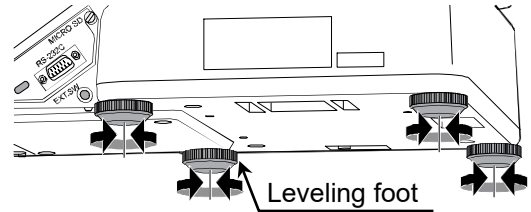

Bubble spirit level

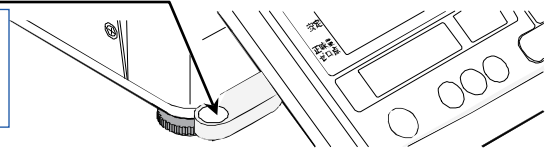
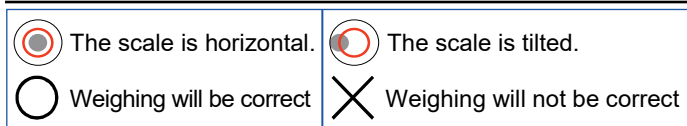

- Perform sensitivity adjustment when the scale is installed for the first time or relocated (refer to “13. Sensitivity Adjustment”).
- Ground the scale by using the grounding terminal when it is used where static electricity occurs.

- Connect the AC adapter to an outlet, and the USB cable to the power input terminal that is on the side of display.

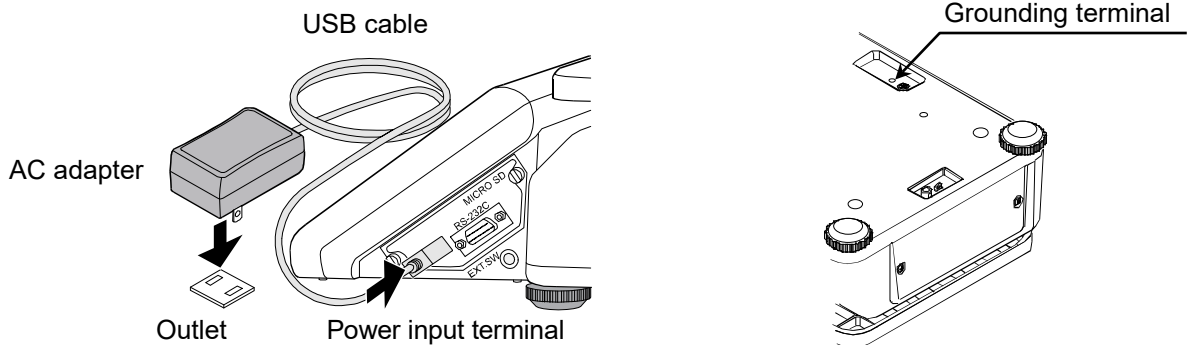

- Performance is not guaranteed if a commercial AC adapter or a USB cable for other products is used.
- When using a mobile battery as a power source, it is recommended that you use one where power can be turned on/off with a switch.
- Set function setting *F-04-08* to “1” if the mobile battery has an automatic power-off function (Operating time will be shortened) (refer to “14. Functions”).
- The table below shows the reference values of continuously usable time with mobile batteries (comparator function being off, no connected devices).

Continuously usable time	
5000 mAh	10000 mAh
Approximately 24 hours	Approximately 50 hours

- Performance is not guaranteed with all mobile batteries.
- Confirm the specifications of mobile batteries before use. Product damage due to mobile batteries will void the warranty.
- Please confirm that the local voltage and the receptacle type are correct for your scale.

 CAUTION

- The power input terminal cannot perform data communication.
- The power input terminal cannot output power.
- Do not connect to any device other than a power source, otherwise the product may be damaged.



8. Basic Operation

8.1. Basic Operation of the Scale

Press the **ON/OFF** key to turn the power on.



Press the **ON/OFF** key again to turn the power off.

- Although the display can be turned off with the **ON/OFF** key, the internal circuit stays energized.

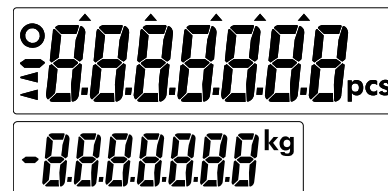

1. Turn the power on without placing anything on the weighing pan.
2. After all the display indicators turn on, the scale displays zero.
3. If the display does not show zero, press the **ZERO** key.
 - If the weighing value does not become stable, "Error 1" is shown. Confirm whether there is something touching the weighing pan, or a strong breeze or vibration can be observed.



Zero-Point Setting

The **ZERO** key sets a zero point when the weighing value is stable within $\pm 2\%$ of weighing capacity based on basing the zero point (power-on zero) when the display turns on. The scale displays zero, and the zero-point mark lights up.

Tare Subtraction

The **TARE** key subtracts the weight of substance on the weighing pan as the weight of tare (container) when the weighing value is stable and more than zero. The scale displays zero, and the net weight mark and zero-point mark light.

Caution: The weighing range is reduced by the tare weight.

Power-On Zero

When the **ON/OFF** key is pressed to turn on the display with nothing on the weighing pan, the scale displays zero together with the zero-point mark lit. The range in which power-on zero is run is less than $\pm 50\%$ of the weighing capacity for zero with sensitivity adjustment.

Power-On Tare

When the **ON/OFF** key is pressed to turn on the display with something on the weighing pan, tare subtraction is run to light the net weight mark and the zero-point mark and to show zero. The range in which power-on tare subtraction is run is $\pm 50\%$ or more of the weighing capacity.

*Less than $\pm 50\%$ of the weighing capacity: Power-on zero (zero-point mark lighting)

* $\pm 50\%$ or more of the weighing capacity: Power-on tare subtraction (net weight and zero-point marks lit)

Near Zero

Near zero is the range within $\pm 4d$ in kg (d = minimum display). This range is regarded as the standard for functions being operated/not operated with comparators, etc.

8.2. Tare Subtraction

Tare subtraction is performed when weighing/counting with a tare (container) to subtract the weight of the tare (container) and display the net value. There are the following two ways to set the tare weight.

- Weigh the actual tare weight to set: Refer to “8.2.1. Set by Weighing a Tare”
- Input the known tare weight with the keyboard Refer to “8.2.2. Input a Tare Weight with the Keyboard”

8.2.1. Set by Weighing a Tare

1. Place a tare (container) alone on the weighing pan and press the **TARE** key.
2. The scale displays “-----”. Wait until the weighing value becomes stable.
3. The scale subtracts the weight of the tare and displays the net weight. The zero-point mark and the net weight mark light up.

Tare (container)

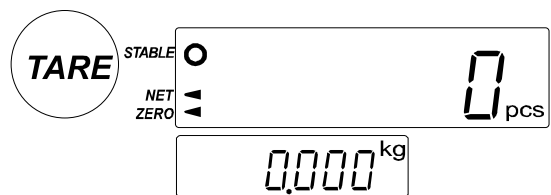
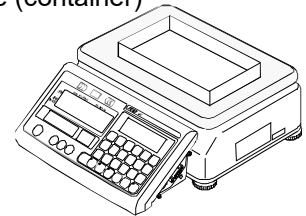

8.2.2. Input a Tare Weight with the Keyboard

1. Remove everything from the weighing pan. If the display does not show zero, press the **ZERO** key to show zero.

2. Press the **KEYBOARD TARE** key. The weight display blinks.

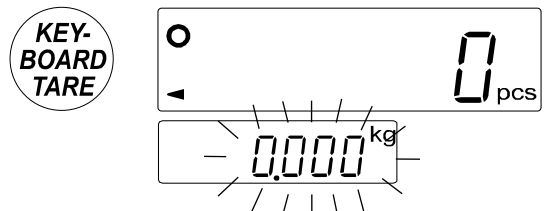

3. Use the numeric keys **0** to **9** to input a tare weight. To correct the value, press the **C** key and re-enter the weight. (The figure to the right shows an example of 615g tare weight.)



4. Press the **ENTER** key. The tare weight is subtracted and the scale displays the net weight. The net weight mark lights up.

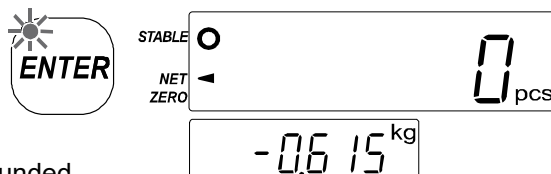

- The values that are entered with numerical keys are rounded off to the minimum display of weight. For example, if entering 123 g with the GC-30K, which has minimum display of 5 g, the tare weight is shown as 125 g.

8.2.3. Clear a Tare Weight

There are the following two ways to clear a tare weight.

Perform a Tare Subtraction at the Zero-Point

1. Remove everything from the weighing pan.
2. Press the **TARE** key.
The tare weight is cleared and the scale displays zero. The net weight mark disappears.
 - If the display does not show zero, press the **ZERO** key to make it show zero.

Input Zero for the Tare Weight

1. Remove everything from the weighing pan.
2. Press the **KEYBOARD TARE** key. The weight display blinks.
3. Input "0" for the tare weight and press the **ENTER** key. The tare weight is cleared and the scale displays zero. The net weight disappears.
 - If the display does not show zero, press the **ZERO** key to make it show zero.



9. Counting

9.1. Prepare to Start Counting

For counting, the weight per one item (unit weight) needs to be set.

1. Press the **ON/OFF** key to turn on the display. Or press the **RESET** key to initialize the previous operation.
2. Three LED lights in the unit weight panel blink and the unit weight setting is activated. This is the default status before counting.
3. Choose one of the following options to set the unit weight for counting, or bring up one from the memory.

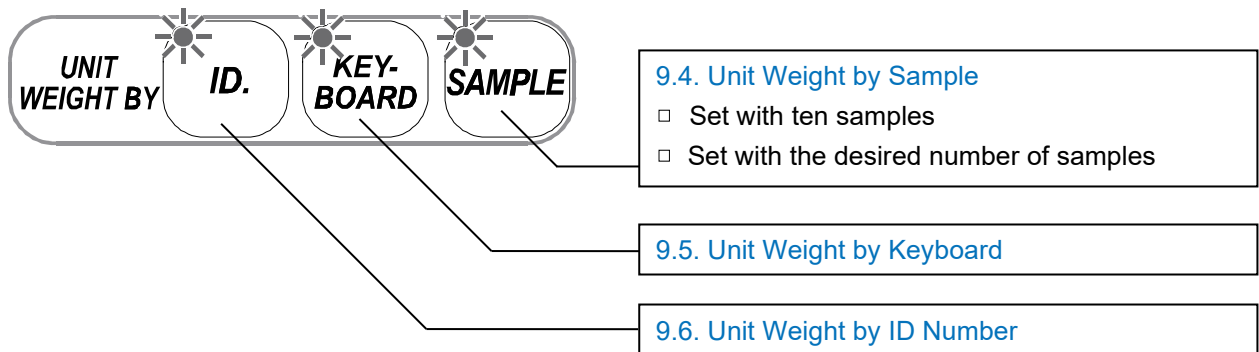

NOTE

Press the **RESET** key to return to the default status above whenever you suspend the operation or are uncertain about the ongoing operation. This does not clear the tare weight, total count, upper limit/lower limit of comparator.

RESET

9.2. Back Up the Unit Weight

The unit weight in use is stored in the internal memory. If the unit weight is reset or the power is turned off accidentally, the memory can be brought up from "ID: 000000" as follows.

1. The three LED lights in the unit weight panel should be blinking.

2. Press the **ID.** key.

The scale displays "ID: 000000".

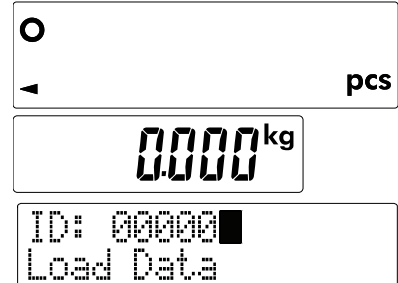
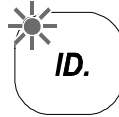

3. Press the **ENTER** key.

The unit weight that was previously used is called up.

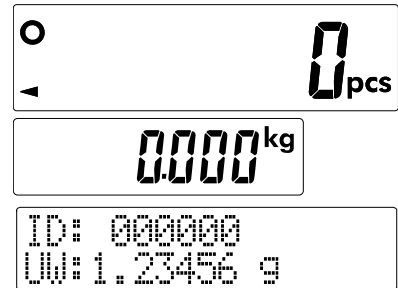

Automatically Call Up the Previous Unit Weight

The unit weight that was previously used can be called up when the display is turned on.

- Set function setting *F-01-04* to "1" to enable this function (refer to "14. Functions").

9.3. Key Restriction Function

This function restricts key operation. If this function is activated, only the keys used for "9.4. Unit Weight by Sample" become usable.

Keys usable when the key operation is restricted



- Set function setting *F-01-01* to "1" to enable this function (refer to "14. Functions").
- Note that all functions that use keys other than the above are disabled.

9.4. Unit Weight by Sample

Setting With Ten Samples

1. Press the **RESET** key. The three LED lights in the unit weight panel blink. If you use a tare (container), place it on the center of weighing pan.

Tare (container)

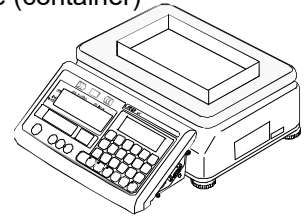

2. Press the **SAMPLE** key. The scale automatically performs tare subtraction with a tare (container) and displays "Add Sample" and "10 pcs."

The number of samples to place on the weighing pan

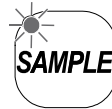

- If the weight display does not show zero, press the **TARE** key. Every time the **SAMPLE** key is pressed, the number of samples to place on the weighing pan changes in the order 5, 25, 50, 100, 10, and back to 5.
- The greater the number of samples is, the higher the accuracy of the unit weight becomes.

3. Place the number of samples that is shown in the display on the weighing pan (or put it in a container).

10 samples

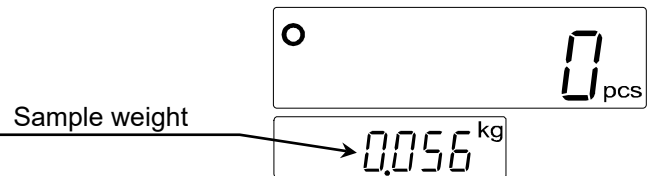
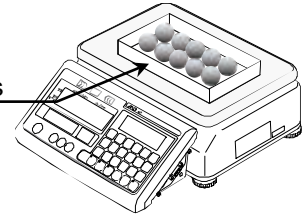

Sample weight

4. Press the **ENTER** key. After showing "-----", the scale displays count, total weight, and unit weight.

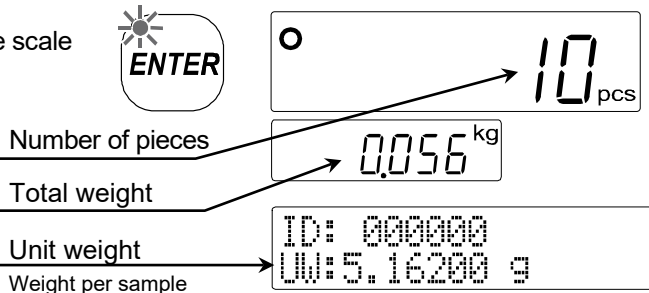

Number of pieces

Total weight

Unit weight
Weight per sample

- If the weight of samples in use is not heavy enough to determine the unit weight (the total weight of samples is not 10.1 times as heavy as the minimum display), the scale displays the number of samples to add together with "Add" (insufficient samples). Add the number of samples accordingly, and then press the **ENTER** key.
- The unit weight is settable even if the **ENTER** key is pressed without additional samples. However, counting accuracy may not be sufficient.

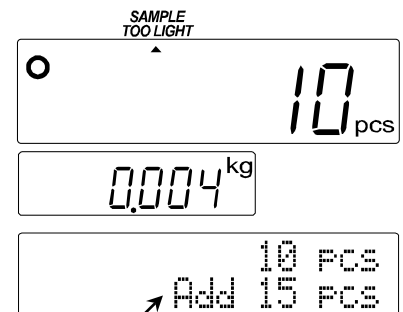

More samples are required. Add 15 more samples.

5. You may begin counting operations using the unit weight entered.

Desired Sample Size

1. Press the **RESET** key. The three LED lights in the unit weight panel blink. If you use a tare (container), place it on the center of weighing pan.

Tare (container)

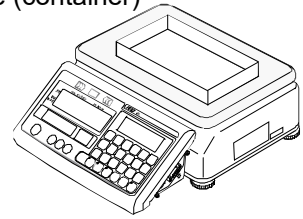

2. Press the **SAMPLE** key. The scale automatically performs tare subtraction operation with a tare (container) and displays “10pcs” and “Add Sample”.



- If the weight display does not show zero, press the **TARE** key.

The number of samples to place on the weighing pan

3. Use the numeric keys **0** to **9** to input the desired number of samples (The figure to the right shows an example of 20 samples).



- If you pressed the wrong key or want to make corrections, press the **C** key.

4. Place the number of samples input on the weighing pan (or put it in the container).

20 samples

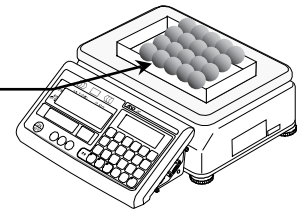

Sample weight

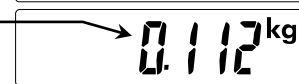

5. Press the **ENTER** key. After showing “-----”, the scale displays count, total weight, and unit weight.



- If the weight of samples in use is not heavy enough to determine the unit weight (the total weight of samples is not 10.1 times as heavy as the minimum display), the scale displays the number of samples to add together with “Add” (insufficient samples). Add the number of samples accordingly, and press the **ENTER** key.

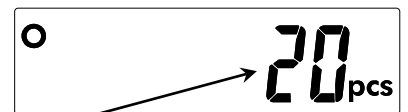

Number of pieces

Total weight

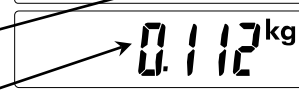

Unit weight

Weight per sample

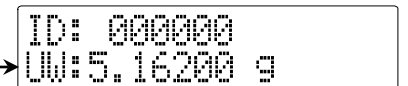

- The unit weight is settable even if the **ENTER** key is pressed without additional samples. However, counting accuracy may not be sufficient.

6. You may begin counting operations using the unit weight entered.

9.5. Unit Weight by Keyboard

1. Press the **RESET** key. The three LED lights in the unit weight panel blink. If you use a tare (container), place it on the center of the weighing pan and press the **TARE** key.

Tare (container)

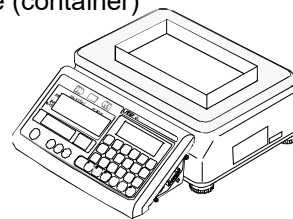

2. Press the **KEYBOARD** key.

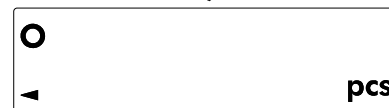

3. Use the numeric keys **0** to **9** to input a known unit weight. (The figure to the right shows an example of 32 g).

- If you pressed the wrong key or want to make corrections, press the **C** key.

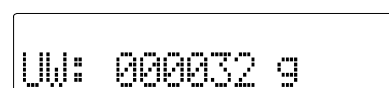

4. Press the **ENTER** key. The unit weight input is set.



Number of pieces

Weight

Unit weight



- If the unit weight that has been input is excessively light (less than minimum countable unit weight), the scale displays “Low Unit Weight” and returns to Step 3. Input the unit weight again.

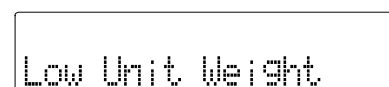

5. You may begin counting operations using the unit weight entered.

9.6. Unit Weight by ID Number

The following explains how to call up a unit weight that is stored in internal or external memory. Set function setting *F-08-02* to internal memory “0” or external memory “1” (refer to “14. Functions”).

- With internal memory, the unit weight needs to be stored in advance (refer to “10.1. Storing Unit Weight”).
- With external memory, a file in the corresponding format must be prepared (refer to “17. SD”).

1. Press the **RESET** key. The three LED lights in the unit weight panel blink. If you use a tare (container), place it on the center of weighing pan to press the **TARE** key.

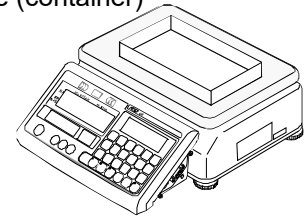

2. Press the **ID.** key. The scale displays “ID: 000000”.

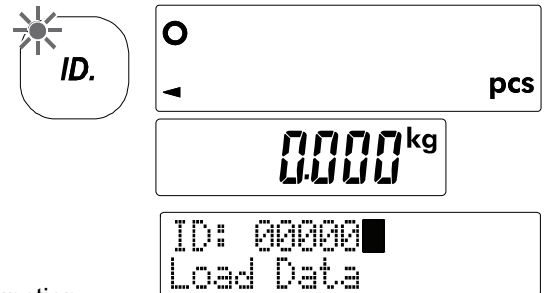

3. ID or item code is selectable as a search key. Also, the AIS function, which calls up unit weight that is closest to the current weighing value, is available. Press the **ID.** key to switch the search key.

- ID search : Refer to “9.6.1. Search by ID Number”
- Item code search : Refer to “9.6.2. Search by Item Code”
- AIS function : Refer to “9.6.3. AIS Function”

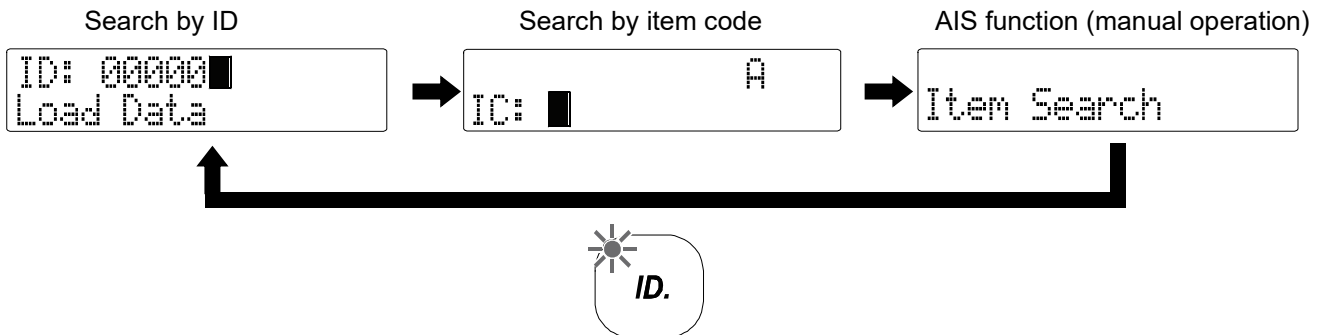

9.6.1. Search by ID Number

1. Use the numeric keys **0** to **9** to input the ID to call up
(The figure to the right shows an example of ID: 123456).



- If you pressed the wrong key or want to make corrections, press the **C** key.

2. Press the **ENTER** key. The unit weight stored in the ID entered is called up.

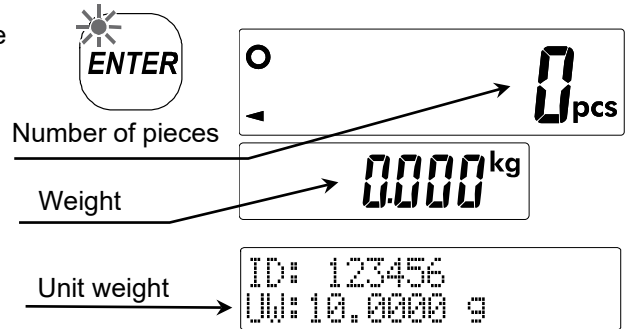

- When the ID entered does not exist, the scale displays “No Data” and returns to Step 1.



Press the ***** key. ID and item code (IC) are switched.

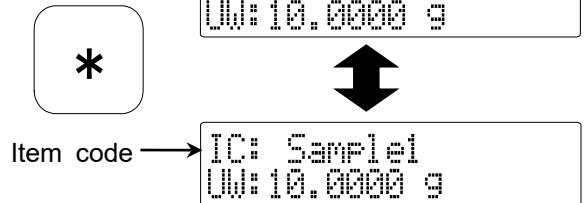

3. You may begin counting operations using the unit weight called up.

NOTE

- “ID: 000000” is for backup. The unit weight that was previously used is automatically stored.
- When unit weight is set, it is automatically stored in “ID: 000000”.
- Even if unit weight is cleared with the **RESET** key, it can be called up from “ID: 000000”.

9.6.2. Search by Item Code

1. Input an item code to call up.

- 0 to 9, . keys : Input characters
- PRINT key : Move the cursor to the left
- TOTAL key : Move the cursor to the right
- M+ key : Change the character type
- C key : Clear a character at the cursor

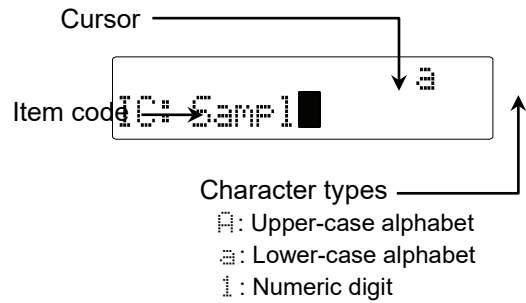

NOTE

- For usable characters, refer to the list of character types in “10.1. Storing Unit Weight”.
- Prefix searches are performed with case sensitivity.
- Spaces cannot be searched.

2. Press the ENTER key. A matching item code is searched, and the unit weight that is stored in the matching item code is called up.

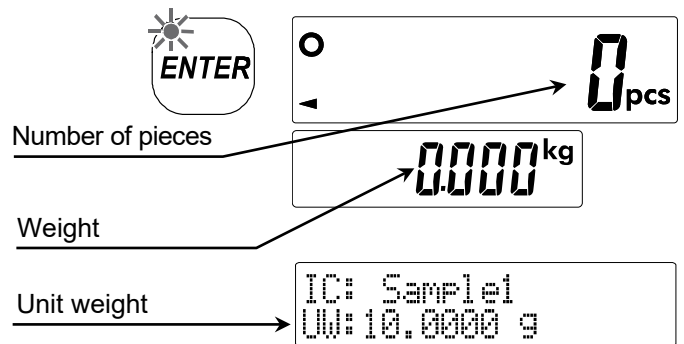

- When the item code is not found, the scale displays “No Data” and returns to Step 1.

No Data
IC: Sample1

Press the * key. ID and item code (IC) are switched.

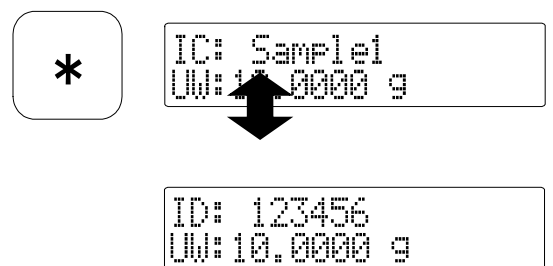

- If the data is not that which you are looking for, hold down the C key and press the ID. key to search the next candidate.

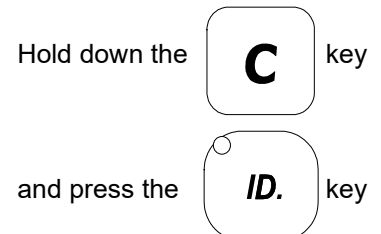

3. You may begin counting operations using the unit weight called up.

List of errors during memory access

Display	Description
No Data	- ID or item code entered does not exist.
Full Data	- The capacity of internal memory is full, and the data cannot be stored. Delete unnecessary data and free up storage space (refer to " 10.2. Clearing a Stored Unit Weight ").
Format Error	- The data format of external memory is wrong. Check the data format (refer to " 17. SD ").
Not Detected	- External memory cannot be detected. Insert external memory (refer to " 17. SD "). - External memory file cannot be found. Check the file name and file format (refer to " 17. SD ").

9.6.3. AIS Function

AIS (Automatic Item Search) calls up a unit weight that is close to the current weighing value by searching memory. With this function, items can be individually identified.

- To use this function, the unit weight needs to be stored in advance.
- The function is usable when the unit weight is heavier than near-zero (within $\pm 4d$ in kg).
- Performing counting operations with inappropriate item data called up causes incorrect results. Make sure that the data called up is that for the appropriate item.

1. Set function setting $F-01-05$ to "1" (refer to "14. Functions").

2. Place nothing on the weighing pan.

- If the scale does not display the weight as zero, press the **ZERO** key to make it display zero.



3. Place one sample to count on the weighing pan.

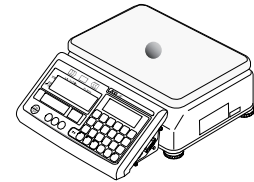

The current weighing value →

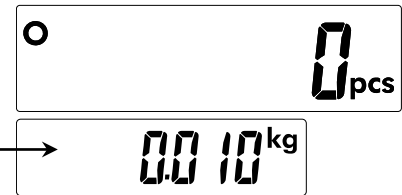

4. The scale automatically searches and calls up a unit weight that is close to the current unit weight. Check the item code (IC) and unit weight. Press the ***** key, and the display of ID and item code is switched.

Item code →

Unit weight →

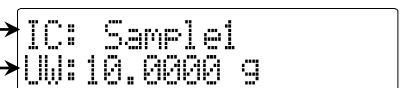

- With internal memory, 10 data that are closer to the weighing value within approximately 5% from the value become candidates.
- With external memory, the data that is within approximately 5% from the weighing value becomes a candidate.

5. You may begin counting operations using the unit weight called up.

- If the data is not that which you are looking for, hold down the **C** key and press the **ID.** key to display the next candidate.

Hold down the **C** key

and press the **ID.** key

When data that is close to weighing value is not found, the scale displays “No Data”.

No Data
Item Search

- To re-search
Make sure that the scale displays “Item Search”, and place the item on the weighing pan again. Press the **ENTER** key, and re-search starts.
- With internal memory, data that has the same unit weight becomes candidates in the order it is located in internal memory. When there is multiple data that has the same or close unit weight, note that the data to be found may not be a candidate.

Manual Operation

1. Place nothing on the weighing pan. If the scale does not display the weight as zero, press the **ZERO** key to make it display zero.

2. Follow Step 3 in “9.6. Unit Weight by ID Number” to display “Item Search”.

Item Search

3. Place one sample to count to the weighing pan.

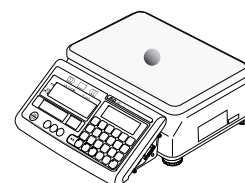

4. Press the **ENTER** key. The scale searches and calls up a unit weight that is close to the current weighing value.



○ pcs

Current weighing value → 00 10^{kg}

5. A unit weight that is close to the weighing value is called up. Check the item code (IC) and unit weight. Press the ***** key. ID and item code (IC) are switched.

Item code → IC: Sample1
Unit weight → UW: 10.0000 g

- With internal memory, 10 data that are closer to the weighing value within approximately 5% from the value become candidates.
- With external memory, the data that is within approximately 5 % from weighing value becomes a candidate.

6. You may begin counting operations using the unit weight called up.
□ If the data is not that which you are looking for, hold down the **C** key and press the **ID.** key to display the next candidate.

Hold down the **C** key
and press the **ID.** key



10. Store Unit Weight

10.1. Storing Unit Weight

1000 types of unit weight can be stored in internal memory together with 6-digit ID (selectable from 000001 to 999999). 20-letter item code (IC) is added to the ID.

1. Set up unit weight in advance to make the scale countable.
Refer to “9.4. Unit Weight by Sample” or “9.5. Unit Weight by Keyboard”.

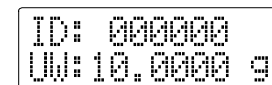

2. Press the **STORE UNIT WEIGHT** key.
The scale displays “ID: 000000”.

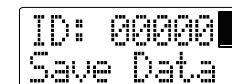

3. Use the numeric keys **0** to **9** to input an ID (the figure to the right shows an example of ID: 123456).
 - “ID: 000000” is for backup and therefore cannot be used.
 - If you pressed the wrong key or want to make corrections, press the **C** key.

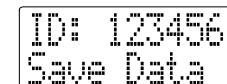

4. Press the **ENTER** key. An item code can be input, and the character type and cursor are shown.

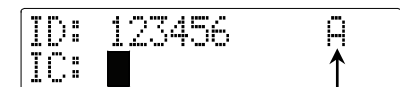

The item code can be input with the following keys. The item code should be up to 20 letters, and upper-case/lower-case alphabet, numeric digits, and symbols are usable.

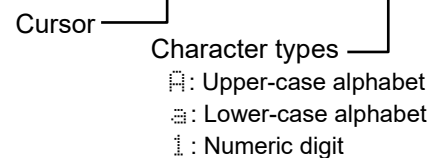

- 0** to **9**, **.** key : Input characters
- PRINT** key : Move the cursor to the left
- TOTAL** key : Move the cursor to the right
- M+** key : Change the character type
- C** key : Clear a character at the cursor

- If you press the **ENTER** key again without inputting an item code, the unit weight is stored without an item code.
- Press the **STORE UNIT WEIGHT** key to input an ID as described in Step 3.

List of character types

Key	Alphabet		Numeric digit
	A (upper case)	a (lower case)	
[1]	@ [] ^ _		1
[2]	A B C	a b c	2
[3]	D E F	d e f	3
[4]	G H I	g h i	4
[5]	J K L	j k l	5
[6]	M N O	m n o	6
[7]	P Q R S	p q r s	7
[8]	T U V	t u v	8
[9]	W X Y Z	w x y z	9
[0]	# \$ % & ' () * + ,		0
[.]	- . / ! " # \$ % & ' () * + ,		.
[C]	Clear (input blank)		

5. Press the **[ENTER]** key.

The scale stores the ID entered and returns to counting.



ID: 123456 a
IC: Sample1

- If a unit weight is already stored in the ID entered, the scale displays a confirmation message if it will be overwritten.

ID: 123456
Over Write?

Confirm if overwriting ID

- Overwrite : Press the **[ENTER]** key.
- Do not overwrite : Press the **[STORE UNIT WEIGHT]** key to return to Step 3. Input a different ID and item code.

0 pcs

6. Press the **[*]** key to switch the display between ID and item code. Check the item code.

0.0000 kg

ID: 123456
UW: 10.0000 g

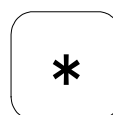

IC: Sample1
UW: 10.0000 g

10.2. Clearing a Stored Unit Weight

To clear an ID data stored in internal memory, perform the following operation.

1. Hold down the **C** key and press the **ID** key. The scale displays "ID: 000000".

Hold down the **C** key

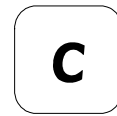

and press the **ID.** key

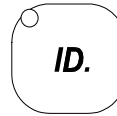

- To clear specific ID data : Step 2
- To clear all ID data : Step 4



Clearing Specific ID Data

2. Use the numeric keys **0** to **9** to input the ID to clear (the figure to the right shows an example of ID: 123456).

- "ID: 000000" is for backup.
- If you pressed the wrong key or want to make corrections, press the **C** key.



3. Press the **ENTER** key. The scale clears the specified ID data and returns to the previous display.

- If the ID specified does not exist, return to Step 2. Either input a different ID or press the **RESET** key to finish.

Clearing All ID Data

4. Press the **TOTAL** key. The scale displays "ID: ALL".

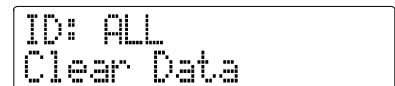

5. Press the **ENTER** key. The scale displays "ID: ALL Clear".



6. Press the **ENTER** key again. The scale clears all ID data and returns to the previous display.

If not clearing all ID data, press the **RESET** key to finish.



or



10.3. Call Up Unit Weight Together with Tare Weight

1. Set function setting $F-00-01$ to “001” (refer to “14. Functions”).
2. Refer to “8.2. Tare Subtraction” to set the tare.
3. With the steps described in “10.1. Storing Unit Weight”, unit weight and tare are stored together.
 - To additionally make an ID to which unit weight has already been registered store tare, call up the ID in advance and perform step 2 and 3.
4. With the steps described in “9.6. Unit Weight by ID Number”, unit weight and tare are called up together.

10.4. Call Up Unit Weight Together with Comparator Upper Limit Value and Lower Limit Value

1. Set function setting $F-00-01$ to “010” (refer to “14. Functions”).
2. Refer to “12.3. Setting Upper Limits and Lower Limits” to set upper limit value and lower limit values.
3. With the steps described in “10.1. Storing Unit Weight”, unit weight, upper limit value, and lower limit value are stored together.
4. With the steps described in “9.6. Unit Weight by ID Number”, unit weight, upper limit value, and lower limit value are called up together.

10.5. Call Up Unit Weight Together with Comparator Upper Limit Value, Lower Limit Value, and Tare Weight

1. Set function setting $F-00-01$ to “011” (refer to “14. Functions”).
2. Refer to “8.2. Tare Subtraction” to set tare.
3. Refer to “12.3. Setting Upper Limits and Lower Limits” to set upper limit value and lower limit values.
4. With the steps described in “10.1. Storing Unit Weight”, unit weight, upper limit value, and lower limit value are stored together.
5. With the steps described in “9.6. Unit Weight by ID Number”, unit weight, upper limit value, lower limit value, and tare are called up together.



11. Total (M+) Function

11.1. Total (M+) Function

- The scale can accumulate count data manually (by pressing the **M+** key) or automatically.
- The number of pieces accumulated and the number of additions (how many times the total was added to) can be viewed with the **TOTAL** key.

Adding Data Manually (by pressing the **M+** key)

1. When the weighing value is stable (stable mark is lit), press the **M+** key. The scale accumulates the number of pieces that have been counted, and the M+ mark blinks for a few seconds.

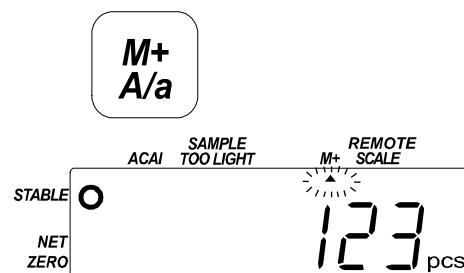

2. Remove counted pieces from the weighing pan. The scale cannot continuously add the same data. Before the next addition, the scale needs to return to near zero.
 - When the scale has accumulated data, the M+ mark lights up.
 - If the scale beeps four times and the M+ mark does not blink, refer to the following note.

NOTE

- The **M+** key is usually accepted only once normally when positive count data is stable. Once accepted, the next accumulation cannot be done until the scale returns to near zero.
- The scale cannot accumulate data at near zero.
- If function setting *F-03-02* is set to "1", the **M+** key can accumulate even negative data. In this case as well, the next accumulation cannot be done until the scale returns to near zero.
- Even if data is accumulated to the total value called up from the memory, the total value in the memory is not updated. To store it in the memory, follow the procedure described in "11.5. Calling Up Unit Weight and Total Count Together".

Erasing the Last Added Data

1. Hold down the **C** key and press the **M+** key.
2. Only the one data instance that was added last is erased from the total value.
 - If the scale beeps four times, it indicates there is no data to be erased.

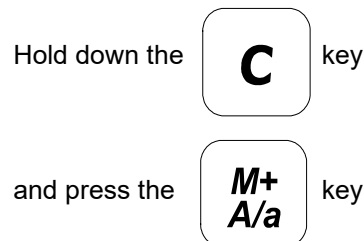

Automatic Accumulation

- The number of pieces counted can be automatically accumulated. When the weighing value is stable (when the stable mark is lit), the number is automatically accumulated and the scale beeps one time. For the next accumulation, remove counted pieces so that the scale returns to near zero.
- To use automatic accumulation, set function setting *F-03-01* to "1".
- Automatic accumulation is operable with positive count data only. Even if function setting *F-03-02* is set to "1" (Accept positive/negative data), the negative count data is not accumulated.

11.2. Viewing the Total Count

1. Press the **TOTAL** key. The scale displays the total count and the number of additions.



- Press the **PRINT** key to output the total count and the number of additions.

Total count → TC: 001234 Pcs
Number of additions → NA: 000007

2. Press the **TOTAL** key again. The display returns to normal.

11.3. Clearing the Total Count

1. Hold down the **C** key and press the **TOTAL** key.

Hold down the **C** key

2. The scale clears the total count, and the M+ mark turns off.

and press the **TOTAL** key

NOTE

- The **RESET** key does not clear the total count or the number of additions.
- Turning power off does not clear the total count or the number of additions.

11.4. Subtraction (M-) Function

- The scale can subtract (M-) count data with the ***** key.
- To use the ***** key as the subtraction (M-) key, set function setting *F-09-01* to "1".
- This function does not clear the last accumulated data. It subtracts the count data and increases the number of additions.
- There is no function to perform automatic subtraction.

11.5. Calling Up Unit Weight and Total Count Together

1. Set function setting *F-08-01* to "100" (refer to "14. Functions").
2. Unit weight, total count, and the number of additions are stored together by following the procedures in "10.1. Storing Unit Weight".
3. Unit weight, total count, and the number of additions are called up together by following the procedures in "9.6. Unit Weight by ID Number".
4. Refer to "11.2. Viewing the Total Count" to check the value that has been called up.



12. Comparator Function

The comparator function compares the number of pieces or weight with upper limit or lower limit. The comparison result is shown in 3 phases as “LO”, “OK”, or “HI”. The buzzer can be set to ring according to the result.

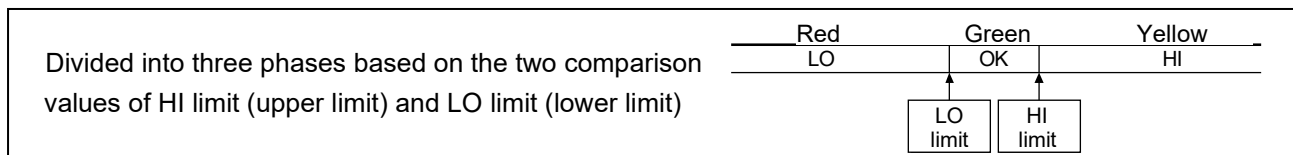

- To use the comparator function, the function setting and upper/lower limits need to be set. For the comparator setting, refer to *F-05-X* in “13.2. Sensitivity Adjustment Using a Weight”.

12.1. Setting the Comparator

- In function setting *F-05-01*, set the comparison mode.

Setting value	Description
0	Turn off the comparator function
1	Compare all data
2	Compare stable data
3	Compare all data except for near zero
4	Compare stable data except for near zero
5	Compare positive data except for near zero
6	Compare positive stable data except for near zero

- In function setting *F-05-02*, set the comparison data.

Setting value	Description
0	Compare data of the number of pieces
1	Compare data of the weight

- In function setting *F-05-03*, set the buzzer to ring according to the comparison result.

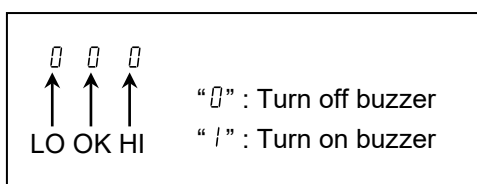

Example) 0 1 0



OK to turn on the buzzer, HI and LO to turn off the buzzer
(Buzzer keeps ringing while OK)

NOTE

- The **RESET** key does not delete upper/lower limits.
- Turning the power off does not delete upper/lower limits.

12.2. Comparison Relation

Comparison judgment is performed with the following formulas.

Result	Judgment method		LED display
LO		Number of pieces or weight < LO limit (lower limit) Number of pieces or weight < Lower limit of weighing range	 Red
OK	LO limit (lower limit) ≤	Number of pieces or weight ≤ HI limit (upper limit)	 Green
HI	HI limit (upper limit) < Upper limit of weighing range <	Number of pieces or weight	 Yellow

12.3. Setting Upper Limits and Lower Limits

- Press the **COMP** key to display upper and lower limits.
Press the **COMP** key again to return to the normal display.



Upper limit → HI: 000100 Fcs
Lower limit → LO: 000050 Fcs

- Set upper limit with the following keys.

0 to **9** keys : Input numerical values
Hold down the ***** key and : Switch + and -
press the **.** key
C key : Clear the input value

HI: 000102 Fcs
LO: 000050 Fcs

(Example) Set upper limit to 102

Press the **ENTER** key to store upper limit and go on to input lower limit.

- Set lower limit with the following keys.

0 to **9** keys : Input numerical values
Hold down the ***** key and : Switch + and -
press the **.** key
C key : Clear the input value

HI: 000102 Fcs
LO: 000098 Fcs

(Example) Set lower limit to 98

Press the **ENTER** key to store lower limit and then return to the normal display.

CAUTION

- Comparison starts to be judged from the top in the table shown in “12.2. Comparison Relation”.
- Upper and lower limits are not judged in terms of large or small. Even if the lower limit is larger than the upper limit, an error message is not shown.
- Upper and lower limits stored in the memory are not updated. To store them in the memory, follow the procedures in “10.4. Call Up Unit Weight Together with Comparator Upper Limit Value and Lower Limit Value”.



13. Sensitivity Adjustment

For accurate weighing, perform sensitivity adjustment when the usage environment is drastically changed such as when the scale is initially installed or the installation site is changed. Also, to maintain a good performance, it is recommended that sensitivity adjustment be done regularly.

13.1. Preparing for Sensitivity Adjustment

- To perform sensitivity adjustment with a weight, a weight (optionally available) should be readied in advance. Power on the scale to warm it up thirty minutes or more before starting sensitivity adjustment.

1. Remove the cable panel.
2. With the display turned on, press the **CAL** switch. “CAL” is shown.
 - Holding down the **TARE** key also shows “CAL”.

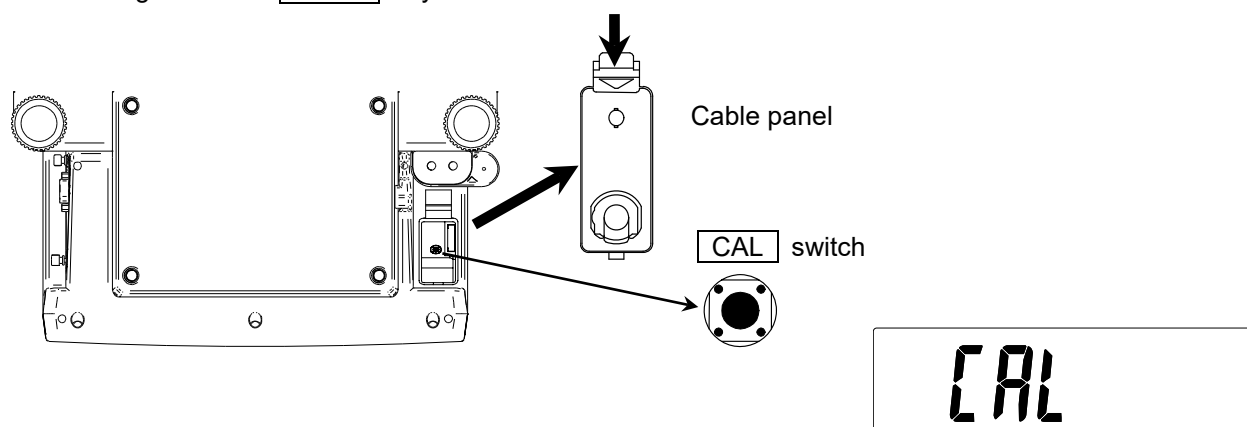

3. Select one of the following.

- ZERO** key : Perform sensitivity adjustment using a weight. (“[13.2. Sensitivity Adjustment Using a Weight](#)”)
Ready a weight in advance.
- TARE** key : Correct with the setting for gravity acceleration value (“[13.3. Correcting Gravity Acceleration](#)”)
- CAL** switch : Restore to factory settings (“[13.4. Initializing Sensitivity Adjustment Value](#)”)

13.2. Sensitivity Adjustment Using a Weight

- The scale displays both “CAL” and weight value (the value to be shown varies depending on the model). Press the **ENTER** key.

- To change the weight value, use the numeric keys **0** to **9** to enter the value. To correct the value, press the **C** key and re-enter it. The figure to the right shows an example for 5 kg.
- Basically, use a weight that is equivalent to the capacity of scale. When using a different weight, it is recommended that it weighs 2/3 or more of the capacity.

CAL

006000 kg

Input with a keyboard

005000 kg

Weight value

ENTER

- The scale displays “CAL 0”.
With nothing on the weighing pan, press the **ENTER** key (sensitivity adjustment at zero point).

Stable mark

CAL 0

005000 kg

ENTER

Nothing on the weighing pan

- The scale displays “CAL F”.
For sensitivity adjustment at zero point only, press the **ON/OFF** key or the **RESET** key to exit.

Stable mark

CAL F

005000 kg

- Place a weight with a value the same as that shown in the display on the weighing pan, and then press the **ENTER** key (sensitivity adjustment for span).

ENTER



- The scale displays “End”. Sensitivity adjustment using a weight is finished. Remove the weight from the weighing pan. The scale enters weighing mode.

CAL

End

- Check if the scale can properly weigh in the weighing mode.
Place the weight on the weighing pan again to make sure that the weight value is within the range $\pm 0.001/0.002/0.004/0.010$ kg (GC3K/GC6K/GC15K/GC30K). If it isn't, take note of the surrounding environment and redo the procedure from step 1.
- Reattach the cable panel.

13.3. Correcting Gravity Acceleration

When the scale is first used or has been moved to a different place, sensitivity adjustment needs to be performed using a weight. But if the weight for sensitivity adjustment cannot be arranged, change the gravity acceleration of your scale to the value of the area where the scale is used. The gravity acceleration setting is not required when sensitivity adjustment using a weight is performed.

1. The scale displays “CAL G” and the gravity acceleration value setting.



2. Use the numeric keys [0] to [9] to enter the gravity acceleration value.

- To correct the value, press the [C] key and re-enter it.

(Refer to “20.3. Gravity Acceleration Map”)

Gravity acceleration value

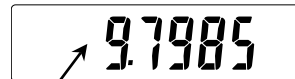

3. Press the [ENTER] key.

This stores the gravity acceleration that has been input and returns to the “CAL” display.



4. Turn on the display again by pressing the [ON/OFF] key or the [RESET] key.



13.4. Initializing Sensitivity Adjustment Value

When sensitivity adjustment is changed due to incorrect operation, the settings for gravity acceleration and sensitivity adjustment using a weight should be returned to the factory settings.

1. The scale displays “CLrC”.



2. Every time the [PRINT] key is pressed, “no” and “G0” are shown alternately.



3. Press the [ENTER] key with “G0” displayed to return the sensitivity adjustment value to the factory setting. After “End” is shown, the scale enters the weighing mode.



- Press the [ENTER] key with “no” displayed to show “CAL” again.

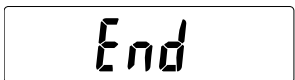
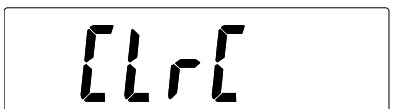



14. Functions

The functions confirms or change the items that specify scale operations. Each setting value is stored even after the power is turned off.

14.1. Function Setting

1. Press the **ON/OFF** key to turn off the display.
2. Hold down the **ZERO** key and press the **ON/OFF** key.
When the software version **P-xxx** is shown, release the keys.

Hold down the **ZERO** key

and press the **ON/OFF** key

P-100

3. Press the **ENTER** key.
On the right side of the weight display, a simplified guide is shown. If there are more items, press either the **PRINT** key or the **TOTAL** key to switch the display.



F-00

4. Enter the appropriate number with the keyboard to change/confirm the function setting.
 - For example, press the **5** key to go to the setting related to comparator function.
 Function setting **F-05-X**: Comparator function

F-05

5. Press the **ENTER** key.
The function setting number is shown in the count display, and the setting value is shown in the weight display.
 - To change the setting : To step 6
 - To check the setting : To step 7



F-05-01

0

6. Use the numeric keys **0** to **9** to change the setting value.
 - To correct the value, press the **C** key to re-enter it.
 - To finish without storing the value entered, press the **ON/OFF** key. Press the **ENTER** key to store the value.

F-05-01

1

7. Press the **ENTER** key to store the setting value and go on to the next item.



8. After changing/checking the necessary setting, press the **ON/OFF** key to turn off the display, and then turn it on again. The new setting is enabled.

F-05-02

0

14.2. Function List

- “◀” indicates the factory setting.

F-00-X: Weight unit

* }	F-00-01 □ Select the weight unit to use.	
	0	g
	1 ◀	kg (the factory setting of metric model)
	2 ◀	lb (the factory setting of non-metric model)
	3	oz
	4	ozt

* This item is only displayed on models corresponded to this function, isn't displayed on other models.

F-00-02	□ Unit weight (when “lb” is selected)	
	0 ◀	lb as piece weight.
	1	lb as 1,000 piece weight.

F-01-X: Unit weight

F-01-01	□ Key lock	
	0 ◀	All keys are enabled.
	1	Keys are enabled only for counting by registering samples. Keys for other counting operation are disabled.

F-01-02	□ Forced unit weight registration with “Add##” (insufficient samples) When the sample weight is insufficient and “Add##” to add samples is displayed, set whether or not the unit weight can be registered without samples being added. Or, set to not display “Add##”.	
	0	Even light unit weight can be registered without “Add##” to add samples being displayed.
	1 ◀	The unit weight can be registered without additional samples even if “Add##” is displayed, with the ENTER key.
	2	The unit weight cannot be registered without additional samples if “Add##” is displayed.

F-01-03	□ Minimum countable unit weight (d = minimum display) Even if the setting is changed, counting accuracy is not improved.	
	0 ◀	1/5d
	1	1/100d

F-01-04	□ Unit weight when the display is on Set whether or not to start with the unit weight reset or with unit weight used last, when the display is on.	
	0 ◀	Unit weight has been reset.
	1	Start with the unit weight used last.

<i>F-01-05</i>	<input type="checkbox"/>	AIS function When placing a load, automatically call up a unit weight that is close to the weighed value (refer to “9.6.3. AIS Function”).
	0 ◀	Disable the function.
	1	Enable the function.

F-02-X: ACAI function

<i>F-02-01</i>	<input type="checkbox"/>	ACAI operation when the unit weight is registered with samples
	0	ACAI does not operate.
	1 ◀	ACAI automatically operates.
	2	ACAI manually operates (with the <input type="button" value="ENTER"/> key being pressed).

<i>F-02-02</i>	<input type="checkbox"/>	ACAI operation when the unit weight is called up with the numeric keys or from ID memory
	0	ACAI does not operate.
	1 ◀	ACAI manually operates (with the <input type="button" value="ENTER"/> key being pressed). However, when <i>F-02-01</i> is set to “0”, the setting of <i>F-02-01</i> is prioritized and ACAI does not operate.
	2	Follow the <i>F-02-01</i> setting.

F-03-X: Total (M+) function

<i>F-03-01</i>	<input type="checkbox"/>	Automatic operation/manual operation
	0 ◀	Manual addition (with the <input type="button" value="M+"/> key)
	1	Automatic addition (only positive data can be added)

<i>F-03-02</i>	<input type="checkbox"/>	Polarity of data to add (additions with the <input type="button" value="M+"/> key only)
	0 ◀	Add positive data only (except for zero range)
	1	Add positive/negative data (except for zero range)

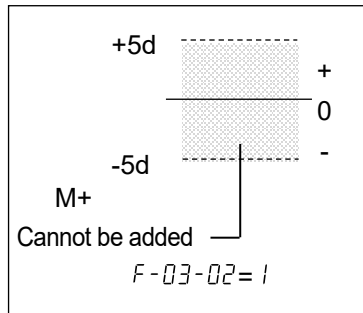
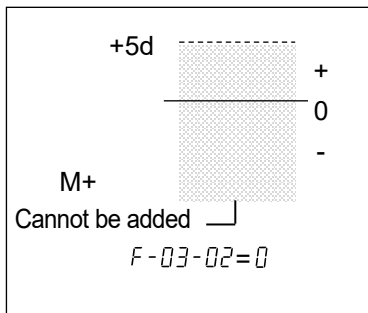

F-04-X: Scale setting

F-04-01	<input type="checkbox"/> Zero tracking function Automatically follow the gradual variation of zero point that generates due to environmental change	
	0	Disable the function.
	1 ◀	Enable the function.

F-04-02	<input type="checkbox"/> Response characteristics	
	0	Response is fast/weak to vibration (good environment, weighing) ↕
	1 ◀	
2	Display where response is slow/stable (stability is prioritized)	

F-04-03	<input type="checkbox"/> Stable detection	
	0	Detect fast (good environment) ↕
	1 ◀	
2	Detect slow (stability is prioritized)	

F-04-04	<input type="checkbox"/> Buzzer Turn on/off the buzzer when operating keys	
	0	Turn off
	1 ◀	Turn on

F-04-05	<input type="checkbox"/> Automatic power-off Turn off the display after a preset time passes when the weighed value is stable and keys are not operated.	
	0 ◀	Disable the function.
	1	5 minutes
	2	10 minutes
	3	15 minutes
	4	30 minutes
	5	60 minutes

F-04-06	<input type="checkbox"/> Automatic power-on	
	0 ◀	Disable the function.
	1	Enable the function.

F-04-07	<input type="checkbox"/> Decimal point	
	0 ◀	Dot
	1	Comma

F-04-08	<input type="checkbox"/> Power source	
	0 ◀	AC adapter
	1	Battery

F-04-09	<input type="checkbox"/> Negative tare Tare is allowed when the total amount is negative within the range of the zero point setting.	
	0 ◀	Disable the function.
	1	Enable the function.

F-05-X: Comparator function

F-05-01	<input type="checkbox"/> Comparison mode	
	0 ◀	Disable the function.
	1	Compare all data.
	2	Compare stable data.
	3	Compare all data except for near zero.
	4	Compare all stable data except for near zero.
	5	Compare positive data except for near zero.
	6	Compare positive stable data except for near zero.

F-05-02	<input type="checkbox"/> Target for comparison	
	0 ◀	Compare count data
	1	Compare weight data

F-05-03	<input type="checkbox"/> Buzzer according to comparison result (refer to "12. Comparator Function")	
	000 ◀	Turn off buzzer for any comparison result

LO OK HI

Setting is required to turn on the buzzer according to comparison result.
Set LO, OK, or HI each to 0 or 1.

"0": Turn off
"1": Turn on

Ex.) The setting "0 1 0" indicates turning on the buzzer with OK and turning it off with HI and LO.
(Buzzer keeps ringing while OK.)

F-06-X: Communication setting

F-06-01	<input type="checkbox"/> Data output mode	
	0 ◀	Key mode A (output data with the <input type="text" value="PRINT"/> key when it is stable)
	1	Auto print mode A (Reference = zero)
	2	Auto print mode B (Reference = last stable value)
	3	Stream mode (commands are not usable)
	4	Key mode B (immediate data output)
	5	Key mode C (output data when stable)
	6	Auto print mode C (output data when in auto print A mode and comparison result is OK)
7	Auto print mode D (output data when in auto print B mode and comparison result is OK)	

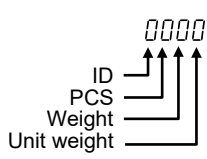
F-06-02	<input type="checkbox"/> Output data	
	0100 ◀	Output count data
		Set data for ID, count, weight, and unit weight with <input type="text" value="0"/> or <input type="text" value="1"/> to select output data. "0": Do not output data "1": Output data Ex.) The setting "1100" indicates outputting of ID and count data.

F-06-03	<input type="checkbox"/> Connected devices	
	0 ◀	General devices (printer, PC)
	1	AD-8561-MI
	2	External instrument

F-06-04	<input type="checkbox"/> Baud rate	
	0 ◀	2400 bps
	1	4800 bps
	2	9600 bps

F-06-05	<input type="checkbox"/> Data length, parity	
	0 ◀	7 bit, even
	1	7 bit, odd
	2	8 bit, non

F-06-06	<input type="checkbox"/> Data format	
	0 ◀	A&D standard format
	1	DP format

F-06-07	<input type="checkbox"/> Command reply	
	0 ◀	No reply to command
	1	Reply to command

<i>F-06-08</i>	<input type="checkbox"/> Auto print polarity	
	0 ◀	Positive only
	1	Negative only
	2	Bipolar

<i>F-06-09</i>	<input type="checkbox"/> Auto print width	
	0 ◀	10d
	1	100d

<i>F-06-10</i>	<input type="checkbox"/> Assignment of comparison result Assign comparison result to output data of the comparison target (<i>F-05-02</i>).	
	0 ◀	Disable the function
	1	Enable the function

<i>F-06-11</i>	<input type="checkbox"/> Assignment of date and time Use date and time in the calendar function for the AD-8127 (output <ESC>D, <ESC> T). Set the print mode for the AD-8127 to "Dump print mode".	
	0 ◀	Disable the function
	1	Enable the function

<i>F-06-12</i>	<input type="checkbox"/> Data output intervals Set intervals for continuous data (approximately 2 seconds)	
	0 ◀	Disable the function
	1	Enable the function

<i>F-06-13</i>	<input type="checkbox"/> UFC function	
	0 ◀	Disable the function
	1	Enable the function

F-07-X: Password lock function

<i>F-07-01</i>	<input type="checkbox"/> Require the administrator's password registered in "Password Registration" to change the function setting. Although the function setting can be changed without a password, the items that can be set are limited.	
	0 ◀	Disable the function
	1	Enable the function

F-08-X: Memory

F-08-01	<input type="checkbox"/> Items to call up from ID memory
	000 ◀ Unit weight (and item code) only
<p>Set data for total, upper and lower limits, and tare with <input type="text" value="0"/> and <input type="text" value="1"/> to select items to call up.</p> <p>“0”: Not to call up “1”: Call up</p> <p>Ex.) The setting “0 10” calls up unit weight (and item code) and upper and lower limits.</p>	
F-08-02	<input type="checkbox"/> Select internal memory or external memory
	0 ◀ Internal memory
	1 External memory

F-09-X: Function assignment

F-09-01	<input type="checkbox"/> * key operation
	0 ◀ Switch ID and item code.
	1 Operate as the <input type="text" value="M-"/> key.
F-09-02	<input type="checkbox"/> Display switch
	0 ◀ Main display: Count Sub display: Weight
	1 Main display: Weight Sub display: Count

F-10-X: External input terminal

F-10-01	<input type="checkbox"/> F-10-01: Key to assign to external input signal #1 <input type="checkbox"/> F-10-02: Key to assign to external input signal #2 Ready a 3.5 mm stereo mini plug (not included in the package) and connect it to a switch, etc. It works by short-circuiting #1 or #2 with GND (100ms or greater).	
F-10-02		
0 ◀		<input type="text" value="RESET"/> (the factory setting of F-10-01)
1 ◀		<input type="text" value="ENTER"/> (the factory setting of F-10-02)
2		<input type="text" value="TARE"/>
3		<input type="text" value="ZERO"/>
4		<input type="text" value="SAMPLE"/>
5		<input type="text" value="REMOTE SCALE"/>
6		<input type="text" value="TOTAL"/>
7	<input type="text" value="M+"/>	
8	<input type="text" value="PRINT"/>	

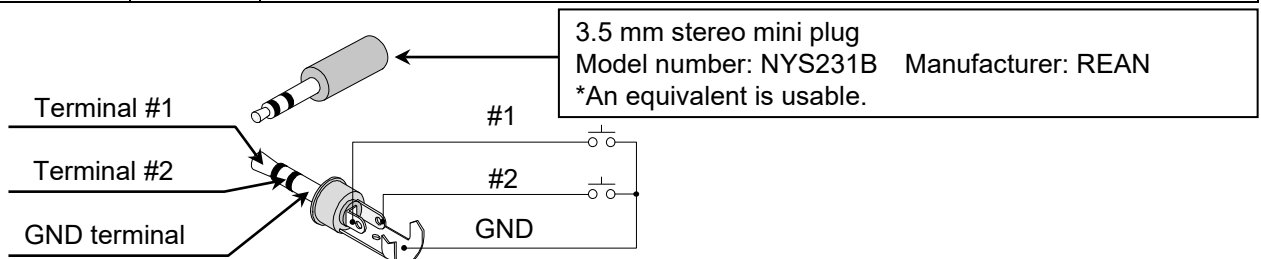

14.3. Password Lock Function

The password lock function limits browsing and changing the function settings of the scale. At the factory setting, the password lock function is disabled. Set to enable/disable the password lock function and to register a password based on the following table.

Function setting	Setting value	Description
F-07-01	0	Disable password lock
	1	Enable password lock
PASSno		Register password

14.3.1. Password Registration

- Press the **ON/OFF** key to turn off display.
- Hold down the **ZERO** key and press the **ON/OFF** key. When the software version **P-xxx** is shown, release the keys.
- Press the **ENTER** key to display "F-00".
- Use the numeric key **9** to display "F-99". Press the **ENTER** key.
- The scale displays "PASSno" and the password (4-digit numbers). The default password is "0000".
- Use the numeric keys **0** to **9** to enter the password to register. (The figure to the right shows an example for password = 1234)
- Press the **ENTER** key to return to the software version **P-xxx** after "End" is shown.

Hold down the **ZERO** key

and press the **ON/OFF** key

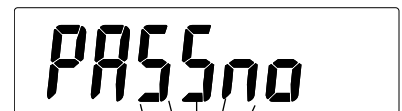

Enter with the numeric keys

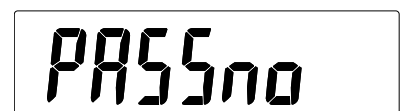
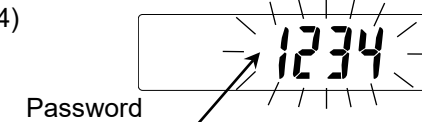

14.3.2. Function Setting after Password Lock

1. Press the **ON/OFF** key to turn off display.
2. Hold down the **ZERO** key and press the **ON/OFF** key. When the software version **P--xxx** is shown, release the keys.

Hold down the **ZERO** key

and press the **ON/OFF** key

3. Press the **ENTER** key.



4. Press the **PRINT** key to select "Adn in" or "GUEST". For the difference between "Adn in" and "GUEST", refer to the table below.

	Limitation of function settings	Password
Adn in	No	Necessary
GUEST	Yes	Not necessary



Adn in



GUEST

Changing Function Settings as Adn in

1. Press the **PRINT** key to select "Adn in".
Press the **ENTER** key.



Adn in

2. "PASSYd" is shown. Use the numeric keys **0** to **9** to enter a password.

PASSYd

0000

Password



Enter with the numeric keys

1234

3. Press the **ENTER** key.
If the password is correct, the scale displays "oL" and then "F-00". Change the setting value by following the steps in "14.1. Function Setting".

FR IL ← **ENTER** NG

OK

oL

If the password is wrong, the scale displays "FR IL" and then return to "Adn in".

F-00

Changing Function Settings as GUEST

1. Select "GUEST" with the **PRINT** key and press the **ENTER** key.
2. "F-00" is shown.
Follow the steps in "14.1. Function Setting" to change the setting value.
As guest, only F-02-X, F-03-X, F-04-X, and F-05-X are changeable.



14.3.3. If You Forget Your Password

If you forget your password, the setting needs to be initialized.

Refer to "14.4. Initialization of Function Settings" to initialize the setting.

- After it is initialized, function settings and comparator values are also reset and need to be set up again.

14.4. Initialization of Function Settings

The values of the individual function settings can be reset to the factory settings with the following operation.

- Password, comparator upper limits and lower limits, total value, and UFC program command are also reset.

1. Press the **ON/OFF** key to turn off display.
2. Hold down the **ZERO** key and press the **ON/OFF** key.
Release the **ON/OFF** key and keep holding down the **ZERO** key.

Hold down the **ZERO** key

and press the **ON/OFF** key

Keep holding down the **ZERO** key
(Release the **ON/OFF** key)

3. "CLrF" is shown.
Release the **ZERO** key.
4. Every time the **PRINT** key is pressed, "no" and "Go" are alternately shown.

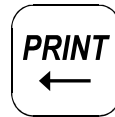
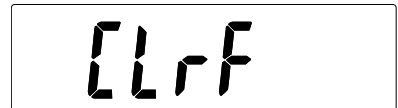

5. Press the **ENTER** key with "Go" shown to reset the values of the function settings to their factory settings. After "End" is shown, the software version in "14.1. Function Setting" is displayed.

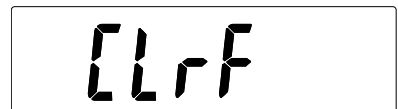

- Press the **ENTER** key with "no" shown to display the software version without initialization.



15. ACAI

15.1. ACAI Function

When unit weight is calculated, the larger the number of samples are, the less error is caused because variation in weight per sample is averaged. However, it is difficult to precisely count a large number of samples. With the ACAI™ (Automatic Counting Accuracy Improvement) function, counting can be started with a small number of samples. And each time samples are added within the range that does not cause counting errors, unit weight is re-calculated and updated.

Precautions for using ACAI

- Make sure to use the ACAI function after registering unit weight. Also, leave samples on the weighing pan.
- Do not remove samples from the weighing pan until ACAI operations are finished.
- There is no need to precisely count samples to add. The range of addable number of pieces is that where the ACAI mark lights up.
- Repeatedly perform ACAI operations up to near the maximum number of pieces to count.
- Even if the same samples are to be counted, to precisely count them, keep registering the sample and performing ACAI operations every time.
- If unit weight is set with the numeric keys or unit weight is called up from memory, it is regarded that 10 samples are registered. With the factory setting, operations are performed manually (with the **ENTER** key). To switch to automatic operation, set function setting *F-02-01* to "1", and *F-02-02* to "2".

15.2. Automatic Operation of ACAI

1. Before performing ACAI operations, register a unit weight.
Leave samples on the weighing pan.

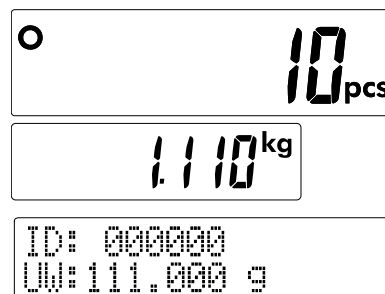
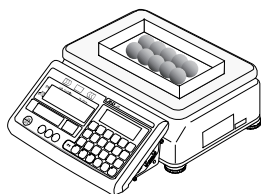

2. Add samples within the range where the ACAI mark lights up (refer to the table on the next page).
 - The ACAI mark lights up within the range where ACAI is possible.
 - As a rough standard, about the same number of pieces as that which is shown in the display can be added.

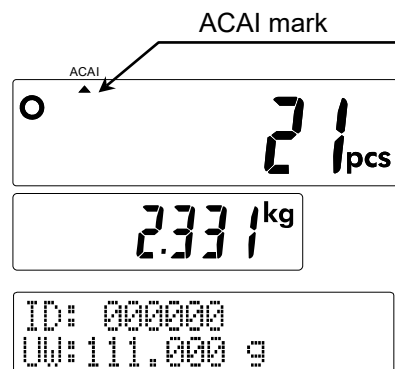

Range where ACAI is possible

Current number of pieces	Number of pieces after being added
10	13 to 26
20	23 to 49
30	33 to 70
40	43 to 89
50	53 to 106

Current number of pieces	Number of pieces after being added
60	63 to 122
70	73 to 138
80	83 to 152
90	93 to 166
100	103 to 299
200	203 to 492



When within the range where ACAI is possible, the ACAI mark lights up.

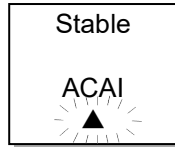

After samples are added and the weighing value becomes stable, the stable mark lights up and the ACAI mark blinks.

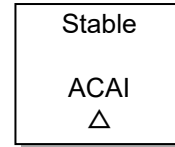

Unit weight is re-calculated, and the ACAI mark turns off.

3. When the number of pieces is within the range where ACAI is possible with the weight value stable, ACAI is performed automatically.
 - When unit weight is re-calculated with ACAI being performed, the ACAI mark blinks and the unit weight display changes to the unit weight value that has been re-calculated.
4. Repeatedly perform ACAI operations until the number of samples becomes sufficient (until it reaches the number to be actually counted).

15.3. Manual Operation of ACAI

- ACAI operations can be performed manually. Press the **ENTER** key to re-calculate the unit weight.
 - To manually perform ACAI operations, set function setting *F-02-01* to "2".
1. Before performing ACAI operations, register a unit weight. Leave samples on the weighing pan.
 2. Add samples within the range where the ACAI mark lights up (refer to the table in "15.2. Automatic Operation of ACAI").
 - Within the range where ACAI operations can be performed, the ACAI mark lights up.
 - As a rough standard, about the same number of pieces as shown in the display can be added.
 3. With the weighing value stable, press the **ENTER** key.
 - When unit weight is re-calculated with ACAI being performed, the ACAI mark blinks and the unit weight display changes to the unit weight value that has been re-calculated.
 4. Repeatedly perform ACAI operations until the number of samples becomes sufficient (until it reaches the number to be actually counted).



16. Communication Specifications

16.1. RS-232C Interface

- Bidirectional communication with RS-232C is available.
- A communication cable is required for connecting to DTE (Data Terminal Equipment) such as a PC, external device, etc.

AX-KO2466-200 (2m) / AX-KO2466-500 (5m)

Connector form	D-Sub 9 pin (male)
Transmission method	Conforms to EIA RS-232C
Transmission form	Asynchronous, bidirectional
Signal form	Baud rate 2400, 4800, 9600 bps
	Data bits 7 bits or 8 bits
	Parity EVEN, ODD (Data bits: 7 bits)
	NONE (Data bits: 8 bits)
	Stop bit 1 bit
	Code ASCII

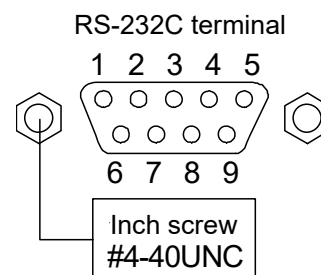

Format for one character (when the data bits are 7 bits)

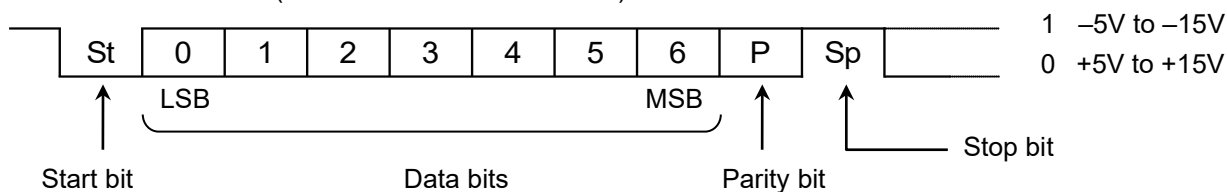

Pin layout

Pin No.	Signal name	Direction	Meaning, remarks
1	-	-	N.C.
2	TXD	Output	Transmit data
3	RXD	Input	Receive data
4	-	-	N.C.
5	SG	-	Signal ground
6	DSR	Output	Data Set Ready
7	RTS	Input	Request to send
8	CTS	Output	Clear to send
9	-	-	7V output*

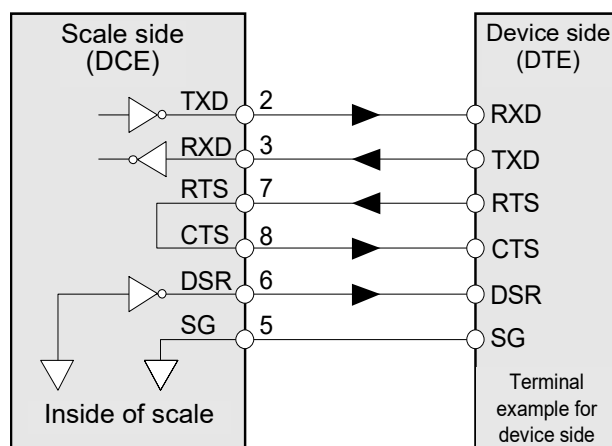

Other than TXD and RXD are the names on DTE side.

*For use with some A&D products.

Do not connect the cables to other manufacturers' products such as a PC and PLC.

Using the wrong connection cable may damage the device. Be sure to check the compatible cable.

16.2. Communication Mode

For the setting related to data output, refer to *F-06-X* in “14.2. Function List”.

A&D Standard Format

S	T	,	+	0	0	0	1	.	2	3	4	␣	k	g	C _R	L _F
Header		Data										Unit		Terminator		

- The two-character header indicates the data condition.
 - ST : Stable weight data
 - QT : Stable count data
 - US : Unstable weight or count data
 - OL : Weight data out of range
- When the comparison result is added (*F-06-10* is set to “1”), the following second header is added to the comparison target (*F-05-02*) after the header above.
 - LO : Comparison result is LO
 - OK : Comparison result is OK
 - HI : Comparison result is HI
 - : No comparison result
- The data is padded with polarity and zeros (filling the data's higher order's surplus part with zeros).
- When data is zero, the polarity is positive.
- The weight unit consists of three characters.
- “␣” indicates a space (ASCII: 20h).
- The terminator is always output with <CR><LF>.
 - C_R <CR> ASCII: 0Dh
 - L_F <LF> ASCII: 0Ah
- As decimal point position and weight unit of data vary depending on the model settings, they may be different from the format example in this manual.
- Example of data format

Weight data	S	T	,	+	0	0	0	1	.	2	3	4	␣	k	g	C _R	L _F			
Count data	Q	T	,	+	0	0	0	0	1	2	3	4	␣	P	C	C _R	L _F			
Weight data with comparison	S	T	,	O	K	,	+	0	0	0	1	.	2	3	4	␣	k	g	C _R	L _F
Count data with comparison	Q	T	,	O	K	,	+	0	0	0	0	1	2	3	4	␣	P	C	C _R	L _F
Weight data out of range	O	L	,	+	0	0	0	0	.	2	3	4	␣	P	C	C _R	L _F			

DP Format (Dump Print)

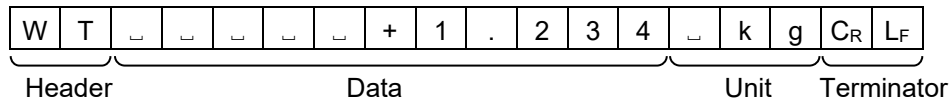

- This format is appropriate for printing with a dump printer such as the AD-8127.
- The two-character header indicates the data condition.
 - WT : Stable weight data
 - QT : Stable count data
 - US : Unstable weight or count data
- When the comparison result is added (*F-05-10* is set to "1"), the header of the comparison target (*F-05-02*) becomes the following comparison result.
 - LO : Comparison result is LO
 - OK : Comparison result is OK
 - HI : Comparison result is HI
 - : No comparison result
- One data instance consists of 16 characters (terminator is not included, except for ID or item code).
- The polarity sign is added right before the data if the data is not overloaded or zero.

Data Output Mode

- Key mode A

When the weighing value is stable (the stable mark is lit), press the **PRINT** key to output data one time. At this time, the display blinks one time to notify that the output has been done.

- Auto print mode A

When the weighing value exceeds the range specified by the $F-05-08$ (auto print polarity) and the $F-05-09$ (auto print width) from the reference "zero display" and the stable value mark is lit, data is output one time. When the stable mark lights up, press the **PRINT** key to output data one time. At this time, the display blinks one time to notify that the output has been done.

- Auto print mode B

When the weighing value exceeds the range specified by the $F-05-08$ (auto print polarity) and the $F-05-09$ (auto print width) from the reference "value previously displayed with a stable value mark" and the stable value mark is lit, data is output one time. When the stable mark lights up, press the **PRINT** key to output data one time. At this time, the display blinks one time to notify that the output has been done.

- Stream mode

This mode continuously outputs data (stream output). Data is output approximately 10 times per second.

- Key mode B

Regardless of whether the stable mark is on or off, press the **PRINT** key to output data one time.

- Key mode C

Press the **PRINT** key to output data one time when the stable mark lights up. When the stable mark is off, data is output one time when the mark lights up next time. At this time, the display blinks one time to notify that the output has been done.

- Auto print mode C

This mode outputs data one time when the conditions for auto print A mode are met and the comparator's comparison result is OK. Also, when the stable mark lights up, press the **PRINT** key to output data one time. At this time, the display blinks one time to notify that the output has been done.

- Auto print mode D

This mode outputs data one time when the conditions for auto print B mode are met and the comparator's comparison result is OK. Also, when the stable mark lights up, press the **PRINT** key to output data one time. At this time, the display blinks one time to notify that the output has been done.

Output Data

Specify with 0 or 1 what data out of ID, count data, weight data, or unit weight data to output.

Example: Enter 1 1 0 0 with numeric keys to output ID (and item code) and count data.

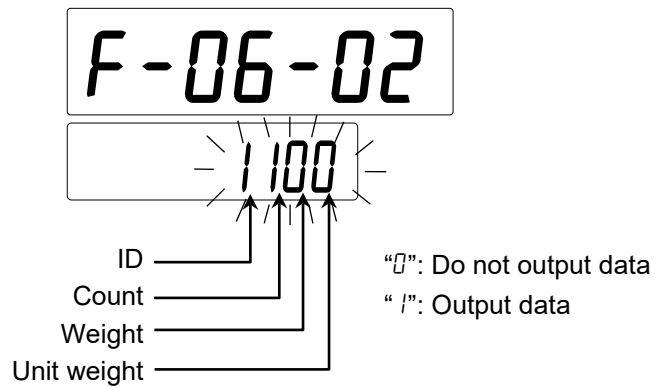

Baud Rate

Select the baud rate according to the device to connect.

- 2400 bps (Set *F-06-04* to "0") Select 2400 bps to connect to an AD-8127.
- 4800 bps (Set *F-06-04* to "1")
- 9600 bps (Set *F-06-04* to "2")

16.3. Commands

By transmitting specified commands from a PC to the scale, you can control requests for weighing data, each key operation, and changes to setting values. This is usable when stream output is not performed. To transmit commands to the scale, add a terminator <CR><LF> to command strings.

Command List

Command	Function	Remarks
@	Start/stop continuous data output (stream output)	Usable during stream output
A	Operate as the <input type="button" value="RESET"/> key	Key command
D	Set tare weight	
E	Store unit weight, other value, or item code in use to a specified ID	
F	Call up memory of a specified ID	
G	Set unit weight	
I	Operate as the <input type="button" value="REMOTE SCALE"/> key	Key command
J	Operate as the <input type="button" value="TOTAL"/> key	Key command
K	Operate as the <input type="button" value="M+"/> key	Key command
Q	Request weighing data (output data immediately)	
S	Request weighing data (output data after weight becomes stable)	
T	Operate as the <input type="button" value="TARE"/> key	Key command
X	Output the list of function settings	
Y	Output the contents of internal memory	
Z	Operate as the <input type="button" value="ZERO"/> key	Key command
?ID	Output ID and item code in use	
?QT	Output count data	
?WT	Output weight data	
?UW	Output unit weight data in use	
?AQ	Output total count	
?AN	Output the number of additions	
?TR	Output tare weight in use	
?MR	Output memory of a specified ID	
MR	Store unit weight and tare weight in a specified ID	
MI	Store item code in a specified ID	
ML	Store upper and lower limits in a specified ID	
MA	Store total count and the number of additions in a specified ID	
CM	Clear memory of a specified ID	
?FC	Output a specified function setting	
FC	Store setting value in a specified function setting	

Acknowledgment and Error Codes

When the scale receives commands from external devices, it responds as follows.

- When a command requests certain data, the scale sends the data. For other commands, the scale sends acknowledgment <AK><CR><LF> to confirm command reception (with function setting *F-05-07*).
 <AK> ASCII: 06h
- When the command is T or Z , the scale sends <AK><CR><LF> again after executing each command.
- When the scale detects any abnormality, it sends the following error code.

Format of the error code

E	C	,	E	*	*	C _R	L _F
---	---	---	---	---	---	----------------	----------------

“*” indicates an error number

Error code	Description
EC,E01	Undefined command Detected a command that has not been defined. Confirm the command that was sent.
EC,E02	Inexecutable Detected a command that cannot be executed. Ex.) Weighing value was requested with Q command when weighing is not displayed.
EC,E04	Excessive characters The number of characters for the command exceeded the acceptable value. Confirm the command that was sent.
EC,E05	No specified ID The specified ID does not exist. Specify an existing ID.
EC,E06	Format error The command format is not correct. Confirm the command that was sent. Ex.) The number of digits for the numerical value is not correct. Alphabet character is entered instead of numerical value.
EC,E07	Setting value error The numerical value of the command is out of the settable range. Confirm the numerical value of command that was sent.
EC,E11	Unstable weight value As the weighing value is unstable, zero and tare cannot be performed. Improve the condition of the installation site.

Data Format

The following are examples of commands. “ ” indicates a space (ASCII: 20h). Response indicates that it is a normal case. An error code is sent when an error occurs (refer to “[Acknowledgment and Error Codes](#)”).

A command that reads from a specified ID is executed for memory that is selected with function setting *F-08-02*. A command that writes to a specified ID is executed for internal memory.

- Request for weighing data

Command

Q	CR	LF
---	----	----

Response

I	D	,	0	0	0	1	2	3	CR	LF											
A	B	C	D	E	F	G	H	I	J	K	L	M	N	O	P	Q	R	S	T	CR	LF

 ID, item code

Q	T	,	+	0	0	0	0	0	1	2	3		P	C	CR	LF
---	---	---	---	---	---	---	---	---	---	---	---	--	---	---	----	----

 Count data

S	T	,	+	0	0	0	1	.	2	3	4		k	g	CR	LF
---	---	---	---	---	---	---	---	---	---	---	---	--	---	---	----	----

 Weight data

U	W	,	+	0	0	0	1	.	2	3	4			g	CR	LF
---	---	---	---	---	---	---	---	---	---	---	---	--	--	---	----	----

 Unit weight data

The item for output data follows function setting *F-05-02*. With the S command, <AK><CR><LF> is sent when the command is received. When the weight is stable, data is output with the format above.

- Set tare weight (Set tare weight to 1.23 kg)

Command

D	:	1	.	2	3	CR	LF
---	---	---	---	---	---	----	----

Response

AK	CR	LF
----	----	----

Tare weight: Up to 8 digits including decimal point

- Store unit weight, other value, or item code in use to a specified ID

Command

E	:	1	2	3	CR	LF
---	---	---	---	---	----	----

 Store in ID: 000123 without item code

E	:	1	2	3	,	a	b	c	CR	LF
---	---	---	---	---	---	---	---	---	----	----

 Store in ID: 000123 with item code “abc”

Response

AK	CR	LF
----	----	----

ID: Up to 6 digits

Item code: Up to 20 digits (When less than 20 digits, enter spaces for the remaining digits)

- Call up memory of a specified ID

Command

F	,	1	2	3	CR	LF
---	---	---	---	---	----	----

 Call up data of ID: 000123

Response

AK	CR	LF
----	----	----

ID: Up to 6 digits

- Output memory of a specified ID

Command

?	M	R	,	1	2	3	C _R	L _F
---	---	---	---	---	---	---	----------------	----------------

Response

M	R	,	0	0	0	1	2	3	,												
A	B	C	D	E	F	G	H	I	J	K	L	M	N	O	P	Q	R	S	T	,	
1	.	2	3	4	5	6	7	,	+	0	0	0	1	.	2	3	4	,			
+	0	0	0	0	5	6	7	8	,	+	0	0	0	0	1	2	3	4	,		
+	0	1	2	3	4	5	6	7	,	0	0	0	0	1	2	3	4	C _R	L _F		

Data is output in the following order and number of digits.

ID (6 digits), item code (20 digits), unit weight (8 digits including decimal point), tare weight (9 digits including sign and decimal point), upper limit value (9 digits including sign), lower limit value (9 digits including sign), total count (9 digits including sign), the number of additions (8 digits)

- Store in a specified ID

For 3 items: Store unit weight and tare weight

For 8 items: Store item code, unit weight, tare weight, upper and lower limits, total count, and the number of additions

Command

M	R	:	1	2	3	,	1	.	2	3	,	0	.	4	5	6	C _R	L _F
---	---	---	---	---	---	---	---	---	---	---	---	---	---	---	---	---	----------------	----------------

Command

M	R	:	1	2	3	,	a	b	c	d	,
1	.	2	3	,	0	.	4	5	6	,	
+	1	0	1	0	,	+	9	9	0	,	
+	6	7	8	9	,	1	2	3	C _R	L _F	

Response

AK	C _R	L _F
----	----------------	----------------

ID: Up to 6 digits

Item code: Up to 20 digits

In the example above, "abcd....." is stored in ID: 000123.

Unit weight: Up to 8 digits including decimal point

Tare weight: Up to 8 digits including decimal point

Upper limit value: Up to 9 digits including sign (- 00999999 to + 00999999)

Lower limit value: Up to 9 digits including sign (- 00999999 to + 00999999)

Total count: Up to 9 digits including sign (-00999999 to + 00999999)

Number of additions: Up to 8 digits (00000000 to 00009999)

- Store item code in a specified ID

Command

M	I	:	1	2	3	,	a	b	c	d	C _R	L _F
---	---	---	---	---	---	---	---	---	---	---	----------------	----------------

Response

AK	C _R	L _F
----	----------------	----------------

ID: Up to 6 digits

Item code: Up to 20 digits

In the example above, "abcd....." is stored in ID: 000123.

- Store upper and lower limits in a specified ID

Command

M	L	:	1	2	3	,	+	1	0	1	0	,	+	9	9	0	C _R	L _F
---	---	---	---	---	---	---	---	---	---	---	---	---	---	---	---	---	----------------	----------------

Response

AK	C _R	L _F
----	----------------	----------------

ID: Up to 6 digits

Upper limit value: Up to 9 digits including sign (- 00999999 to + 00999999)

Lower limit value: Up to 9 digits including sign (- 00999999 to + 00999999)

- Store total count and the number of additions in a specified ID

Command

M	A	:	1	2	3	,	+	6	7	8	9	,	1	2	3	C _R	L _F
---	---	---	---	---	---	---	---	---	---	---	---	---	---	---	---	----------------	----------------

Response

AK	C _R	L _F
----	----------------	----------------

ID: Up to 6 digits

Total count: Up to 9 digits including sign (- 00999999 to + 00999999)

Number of additions: Up to 8 digits (00000000 to 00009999)

- Clear memory of a specified ID

Command

C	M	:	1	2	3	C _R	L _F
---	---	---	---	---	---	----------------	----------------

Clear memory of ID: 000123

Response

AK	C _R	L _F
----	----------------	----------------

ID: Up to 6 digits

- Output a specified function setting

Command

?	F	C	,	0	5	0	1	C _R	L _F
---	---	---	---	---	---	---	---	----------------	----------------

Request for setting value of function setting *F-05-01*

Response

F	C	,	0	5	0	1	,	0	C _R	L _F
---	---	---	---	---	---	---	---	---	----------------	----------------

F-05-01 = "0"

Function setting number: 4 digits

- Store setting value in a specified function setting

Command

F	C	:	0	6	0	2	,	0	1	1	1	C _R	L _F
---	---	---	---	---	---	---	---	---	---	---	---	----------------	----------------

 Output count, weight, and unit weight

Response

AK	C _R	L _F
----	----------------	----------------

Function setting number: 4 digits

Setting value: Refer to "14.2. Function List"

The new setting will take effect when the display is turned off and on again.

- Output the list of function settings

Command

X	CR	LF
---	----	----

Response

F	C	,	0	0	0	1	,	1	CR	LF
F	C	,	0	0	0	2	,	0	CR	LF
F	C	,	0	1	0	1	,	0	CR	LF

F	C	,	1	0	0	2	,	1	CR	LF
EOT	CR	LF								

At the end of data, <EOT><CR><LF> is output.

<EOT> ASCII: 04h

- Output the contents of internal memory

Command

Y	CR	LF
---	----	----

Response

M	R	,	0	0	0	0	0	1	,	a	b	c	_	_	_	_	_	_	_		
_	_	_	_	_	_	_	_	,	1	.	2	3	4	5	6	7	,	+	0	0	0
1	.	2	3	4	,	+	0	0	0	0	0	1	0	0	,	-	0	0	0	0	0
0	1	0	0	,	+	0	0	0	0	0	1	0	0	0	,	0	0	0	0	0	0
1	0	CR	LF	M	R	,	0	0	0	0	0	2	,	d	e	f	_	_	_	_	_

0	0	0	0	0	0	0	5	CR	LF	EOT	CR	LF
---	---	---	---	---	---	---	---	----	----	-----	----	----

Data stored in internal memory is output in the following order and number of digits.

ID (6 digits), item code (20 digits), unit weight (8 digits including decimal point), tare weight (9 digits including sign and decimal point), upper limit value (9 digits including sign), lower limit value (9 digits including sign), total count (9 digits including sign), number of additions (8 digits)

At the end of data, <EOT><CR><LF> is output.

<EOT> ASCII: 04h

16.4. UFC (Universal Flex Coms) Function

The UFC (Universal Flex Coms) function enables arbitrary descriptions to be output when weighing data is output.

- Send a program command corresponding to the output format, to the scale and make it store the command. The program command stored is held even if the power of the scale is turned off.
- The number of characters used for the program command is up to 1000.
- To use the UFC function, the UFC format needs to be stored in the scale in advance.
- To use the UFC function, set function *F-06-13* to "1".
- The beginning of program command should be "PF,".
- The end of program command (the end of string) should be <CR><LF>.
- The variable command is replaced with the scale's weight data or tare data.

Example of Program Command

Command	P	F	,	\$	P	C	,	'	T	E	X	T	'	,	#	2	0	,	\$	S	P
	*	2	,	\$	C	R	,	\$	L	F	,	\$	W	T	,	\$	C	R	,	\$	L
	F	CR	LF																		
Response	AK	CR	LF																		

List of Variable Commands and Control Codes

Command	Description	Output example								
PF,	Program command header This is added to the beginning of the program command.									
<CR><LF> >	Program command terminator This is added to the end of the program command.									
\$PC	Count data	┌ ┌ ┌ ┌ + 1 2 3 4 ┌ P C								
\$WT	Weight data	┌ ┌ ┌ + 3 . 2 1 0 ┌ k g								
\$UW	Unit weight data	+ 1 . 2 3 4 5 6 7 ┌ ┌ g								
\$TR	Tare data	┌ ┌ ┌ + 1 . 2 3 4 ┌ k g								
\$TL	Total count	┌ ┌ + 9 9 9 9 9 9 ┌ P C								
\$AN	Number of additions	┌ ┌ ┌ ┌ 1 2 3 4								
\$CD	ID in use	0 0 0 1 2 3								
\$NM	Item code in use	A B C D ┌ ┌ ┌ ┌ ┌ ┌ ┌ ┌ ┌ ┌ ┌ ┌ ┌ ┌ ┌ ┌								
\$CP	Comparator result	<table border="1"> <tr><td>L</td><td>O</td></tr> <tr><td>O</td><td>K</td></tr> <tr><td>H</td><td>I</td></tr> <tr><td>┌</td><td>┌</td></tr> </table> Comparison result is LO Comparison result is OK Comparison result is HI No comparison result	L	O	O	K	H	I	┌	┌
L	O									
O	K									
H	I									
┌	┌									
\$CM	Comma	┌ , ┌ ASCII: 2Ch								
\$SP	Space	┌ ┌ ASCII: 20h								
\$CR	<CR>	ASCII: 0Dh								
\$LF	<LF>	ASCII: 0Ah								

- Use upper case characters for the command above.
- ASCII character strings

Enclose arbitrary ASCII code character strings in single quotation marks. Usable character strings are alphabet, numeric, and symbol. Single quotation marks in the string are shown using two single quotation marks.

Ex.) When outputting character string ABC: 'ABC'
 When outputting character string 'ABC': ""ABC""
- ASCII control code

Enter ASCII control codes with # and two characters in hexadecimal.

Ex.) When outputting <EOT> (04h): #04
- Data repetition

Control codes \$SP, \$CR, and \$LF can be repeated for the number of numeric characters used for each code if * and numeric characters (up to two characters) are added after them.

Ex.) When outputting 12 spaces: \$SP* 12
 When outputting 9 <CR>'s: \$CR* 9
- Combining mark

When two or more lines of program commands are sent, it is judged that the program command continues to the next line if "&" (&<CR><LF>) is added to the end of a line.

Ex.) \$WT\$CR\$LF&<CR><LF>
- To separate each data, use a space or ",". Although the separation is also a part of characters to be stored, it can be omitted to reduce the number of characters. However, "," for the program command header cannot be omitted. Make sure to start it with "PF,".
- In the UFC format, a terminator is not automatically sent. Put a terminator code (\$CR\$LF) at the end of character data as needed.
- Put a terminator code (\$CR\$LF) immediately before the last terminator <CR><LF> of the program command. Depending on the printer or data processing software, output may be properly performed with the data format created.
- The scale sends an error code if there is a problem when receiving a program command. It sends <AK><CR><LF> if there is no problem.

Examples of Printing and Program Commands

```
ID 000001
PN Sample_Data
Count
      +1234 PC
Unit Weight
      +1.234567 g
Weight
      +1.5235 kg
Result
      HI
```

```
PF,'ID '$CD$CR$LF&<CR><LF>
'PN '$NM$CR$LF&<CR><LF>
'Count'$CR$LF&<CR><LF>
$SP* 4$PC$CR$LF&<CR><LF>
'Unit Weight'$CR$LF&<CR><LF>
$SP* 4$UW$CR$LF&<CR><LF>
'Weight'$CR$LF&<CR><LF>
$SP* 4$WT$CR$LF&<CR><LF>
'Result'$CR$LF&<CR><LF>
$SP* 11$CP$CR$LF&<CR><LF>
```



17. SD

17.1. Usable Type of SD Card

This product uses the following type of microSD card as external memory, with which it can call up data such as unit weight from a list file created.

Form	microSD
Card type	SDHC
File system	FAT32

- Format the SD card in FAT32 before use.
- Operation has been confirmed with RP-SMGA04GJK (4GB) manufactured by Panasonic.
- Operation cannot be guaranteed with all devices. Depending on the manufacturer, some SD cards may not be usable. Operation related to problems that occur with specific devices (commonly referred to as compatibility) cannot be guaranteed.
- Do not insert or remove the SD card from the scale when the display is on. Doing so may cause damage or deletion of data.
- Do not turn off power when accessing the SD card. Doing so may cause damage or deletion of data.
- Do not put unrelated data (files or folders) onto the SD card. Doing so may cause damage or deletion of data.
- Data on the SD card may be damaged or deleted due to unexpected accident. Back up data regularly to an external memory device in advance.
- A&D bears no responsibility with respect to damage or deletion of data stored on the SD card, regardless of the details or cause of damage or loss.

17.2. Data Format

Make a list file on the SD card in the following data format.

File type	CSV
File name	List.csv



List.csv

- The number of characters should be within 120 per line and within 60 per cell.
- When files are edited or saved with spreadsheet applications such as Excel, numerical values can be unintentionally changed as shown below. In this case, note that format error or unintentional numeric values are generated.
 - When the number of digits is large, 4981046000001, → 4.98105E+12,
the numeric value is shown in exponent notation.
 - A space is added to the end of 4981046000001, → 4981046000001 ,
data.
- * Excel is a registered trademark or trademark of Microsoft Corporation in the United States and/or other countries.
- Do not use a comma (,) for the item code or decimal point. It will be mistakenly recognized as separation character.

	Column A ID	Column B Item code	Column C Unit weight	Column D Tare	Column E Upper limit	Column F Lower limit	Column G Total count	Column H Number of additions
	A	B	C	D	E	F	G	H
1	4981046000001	Sample 1	1.23	0	0	0	0	0
2	4981046000002	Sample 2	2.34	0.1	1000	500	10	1
3	4981046000003	Sample 3	3.45	0.1	10	-10	20	2
4	4981046000004	Sample 4	4.56	0.1	10	-10	30	3
5	4981046000005	Sample 5	5.67	0.1	10	-10	40	4
6	4981046000006	Sample 1	10.123	0	0	0	0	0
7	4981046000007	Sample 2	20.456	1	200	100	100	10
8	4981046000008	Sample 3	30.789	1	200	100	200	20
9	4981046000009	Sample 4	100.123	1	200	100	300	30
10	4981046000010	Sample 5	200.456	1	200	100	-100	40
11								

Details of Each Item

ID	<ul style="list-style-type: none"> - Numeric characters (without sign or decimal point). - When it exceeds six digits, the last six digits are recognized as the ID. "4981046000005" is recognized as "ID: 000005". - Do not set duplicate values. - "ID: 000000" is for backup and therefore cannot be used. 												
Item code	<ul style="list-style-type: none"> - Alphabet characters (upper case, lower case), numeric characters, symbols. - When it has less than 20 characters, spaces are added to remaining digits for recognition. When it has more than 20 characters, the first 20 characters from the top are recognized as the item code. - If an item code is not used, do not set anything. 												
Unit weight	<ul style="list-style-type: none"> - Numeric characters (without sign, with decimal point, up to eight digits). - It is recognized as the weight unit that is being selected. However, "kg" is recognized as "g". - Set a value larger than the minimum countable unit weight. 												
Tare	<ul style="list-style-type: none"> - Numeric characters (without sign, with decimal point, up to 8 digits). - When it is called up, it is converted to a value that is aligned with the minimum display. - It is recognized as the weight unit that is being selected. - Set it to 0 when it is not used. 												
Upper limit value, lower limit value	<ul style="list-style-type: none"> - Numeric characters (with sign, without decimal point, - 999999 to 999999). - When the upper limit value is 1000 and lower limit value is 500, they are recognized as follows with the GC-3K. <table border="1" data-bbox="331 1653 1209 1818"> <thead> <tr> <th></th> <th>Upper limit</th> <th>Lower limit</th> </tr> </thead> <tbody> <tr> <td>Count comparison [pcs]</td> <td>1000</td> <td>500</td> </tr> <tr> <td>Weight comparison [kg]</td> <td>0.1000</td> <td>0.0500</td> </tr> <tr> <td>Weight comparison [g]</td> <td>100.0</td> <td>50.0</td> </tr> </tbody> </table> <ul style="list-style-type: none"> - Set it to 0 when it is not used. 		Upper limit	Lower limit	Count comparison [pcs]	1000	500	Weight comparison [kg]	0.1000	0.0500	Weight comparison [g]	100.0	50.0
	Upper limit	Lower limit											
Count comparison [pcs]	1000	500											
Weight comparison [kg]	0.1000	0.0500											
Weight comparison [g]	100.0	50.0											
Total count	<ul style="list-style-type: none"> - Numeric characters (with sign, without decimal point, - 999999 to 999999). - Set it to 0 when it is not used. 												
The number of additions	<ul style="list-style-type: none"> - Numeric characters (without sign or decimal point, 0 to 9999). - Set it to 0 when it is not used. 												

17.3. Inserting SD Card

1. Turn off the display.
Loosen the two screws to draw out the power panel.
You can see the SD card slot inside.
2. Slide the slot cover in the direction indicated by the arrow.
 - Do not apply strong force or impact to the SD card or the slot. Do not bend them or wet them with water. Doing so may damage them.
3. Pull up the slot cover.
4. Insert a microSD card that has a list file to the slot.
 - The SD card has a specific orientation. Set it in the appropriate orientation, and insert it fully.
 - Do not put a label on the surface of the SD card.
 - Do not touch the metal terminal of the SD card with your hand or with other metal.
5. Close the slot cover.
6. Slide the slot cover in the direction indicated by the arrow.
7. Close the power panel to fasten the two screws.

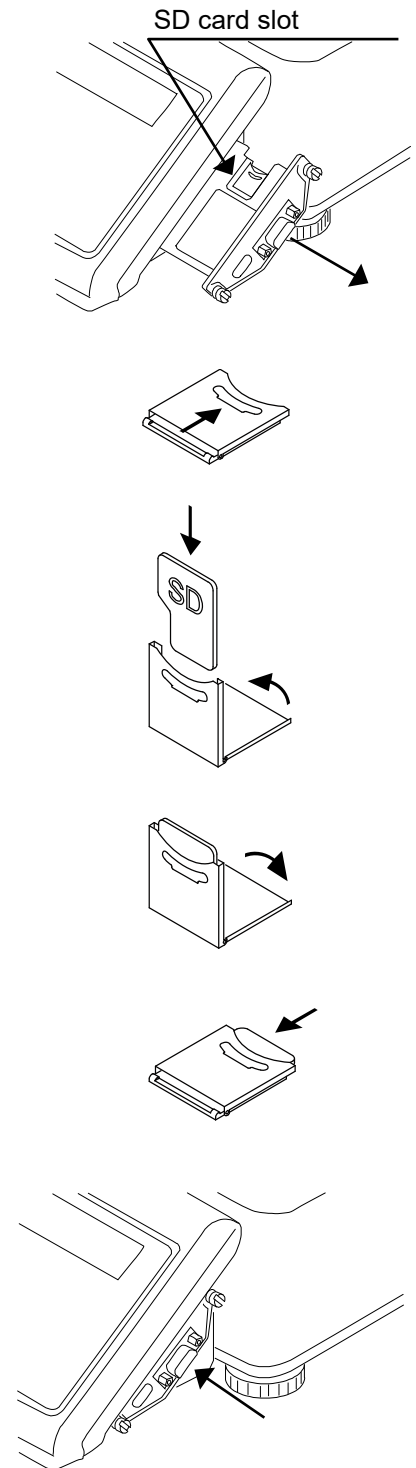

CAUTION

- Do not open or close the power panel with the slot opened. Doing so may cause damage to the SD card and the slot.

8. Select “/” external memory with function setting *F-08-02*. Refer to “14. Functions”
Data can be called up from external memory. Refer to “9.6. Unit Weight by ID Number”

17.4. Copying Data

Copy data on external memory (microSD card) to the internal memory.

- Do not turn off the power while copying data. Doing so may damage or delete data.
- Up to 1000 data instances can be copied. When the number of data in a list file exceeds 1000, up to 1000th data is copied.
- When data is copied, internal memory is temporarily completely deleted.
- If a format error is detected and copying canceled while in progress, data that could be read normally up to that point is copied.

1. Insert a microSD card that has a list file to the slot, and close the power panel.

2. Enter the function mode (refer to “14. Functions”).

3. Use the numeric key **8** to display “F-88”.
Press the **ENTER** key.

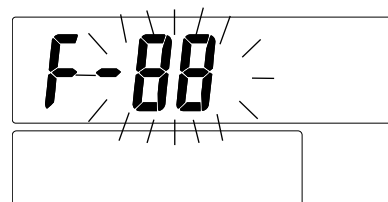

4. “CoPY” is shown. Press the **STORE UNIT WEIGHT** key to start copying data from external memory to internal memory (display blinks).

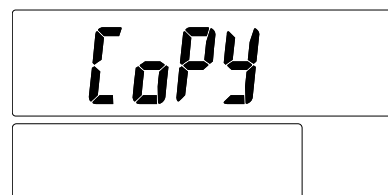

5. If copying is finished normally, “oL” is shown.

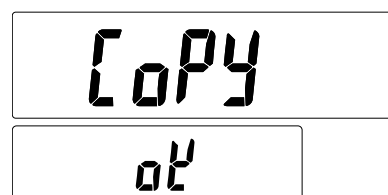

- If copying is canceled due to format error, “FAiL” is shown. Check the data format.

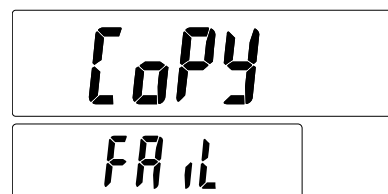

6. Press the **RESET** key to return to “CoPY”.

7. Confirm that there is no problem with copied data in weighing mode.



18. Options

18.1. Options List

Option name	Description
AX-KO2466-200	Cable for RS-232C, D-Sub 9 pin, 2 m
AX-KO2466-500	Cable for RS-232C, D-Sub 9 pin, 5 m
AX-TB301	AC adapter (without cable)
AX-KO7215-150	USB A to C cable, 1.5 m
GC-08	Extension cable for display, 2 m
AD-8561-MI02	Barcode reader, RS-232C, USB interface
AD-8561-MI04	Barcode reader, RS-232C, relay output interface
AD-8561-MI05	Barcode reader, RS-232C, remote scale interface
GC-14	Attachment mount (AD-8561-MI main unit holder, cable holder)

18.2. AD-8561

The AD-8561-MI02/04/05 allows the use of bar code readers, relay outputs, etc.

- When using the AD-8561, set function setting *F-06-03* to “1”.
- For detailed specifications, refer to the instruction manual for the AD-8561.

18.2.1. Input With Barcode Reader/Keyboard

Available with the AD-8561-MI02/04/05.

A barcode reader or keyboard can be used for ID or item code input. Upper-case/lower-case alphanumeric characters are usable.

18.2.2. Comparator Relay Output

Available with the AD-8561-MI04.

The comparator relay output is usable as a relay output for comparator comparison results. Set the upper limit/lower limit values, *F-05-01*, and *F-05-02* (comparison conditions). Set function setting *F-06-10* (addition of comparison result) to “1”.

18.2.3. Interface for Remote Scale

Available with the AD-8561-MI05.

With a load cell type of weighing platform, a two-scale system can be structured.

Sensitivity Adjustment of Remote Scale

When connecting a remote scale for the first time, set the weighing capacity and minimum display and perform sensitivity adjustment using a weight.

1. Connect a remote scale via the AD-8561-MI05.
 - Prepare a weight (separately sold) in advance.
 - Connect the power 30 minutes or more before starting sensitivity adjustment. Turn on the display (warm up).
2. Remove the cable panel and press the **CAL** switch. "CAL" is shown.
 - To cancel the operation, press the **RESET** key.
3. Press the **REMOTE SCALE** key to light up the remote scale mark (remote scale is selected). Press the **ENTER** key.

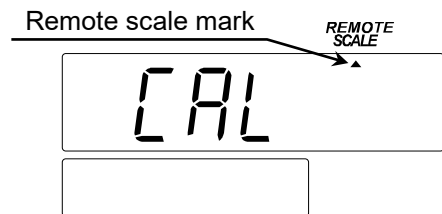

4. Use the numeric keys **1**, **2**, **5**, and **.** to enter minimum display. Press the **ENTER** key.

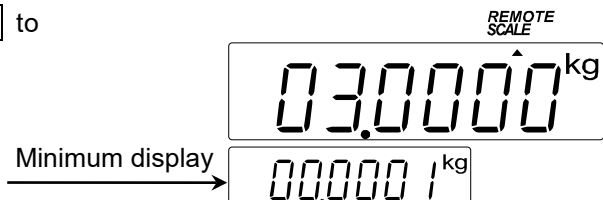

5. Use the numeric keys **0** to **9** and **.** to enter weighing capacity. Press the **ENTER** key.

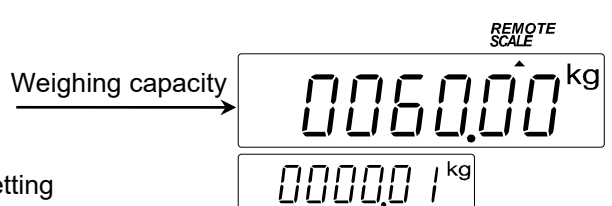

- The figure to the right shows an example of setting weighing capacity to 60.00 kg and minimum display to 0.01 kg.

6. "CAL" is shown. Weighing capacity/minimum display has been set and the remote scale is ready for sensitivity adjustment.
7. Check that the remote scale mark is lit (remote scale is selected). Refer to "13.2. Sensitivity Adjustment Using a Weight" to perform sensitivity adjustment of the remote scale.
8. Press the **REMOTE SCALE** key in weighing mode to switch to the remote scale. Confirm that it can properly weigh.

Caution When Using Remote Scale

- To count with an accurate unit weight, register the unit weight with a sample by using the main scale and perform ACAI. Then, switch to the remote scale.
- Perform tare subtraction with the main scale and remote scale respectively.
- When using a remote scale, if the unit weight is registered with the main scale and then it is switched to a remote scale, ACAI does not work. The opposite is also same.

Required Specifications of Remote Scale

- A weighing platform with up to four 350 Ω load cells can be connected.
- The range of the remote scale's weighing capacity is from 0.001 kg to 500000 kg.
- When weighing capacity/minimum display exceeding 1/10000 are set, internal sensitivity per 1 d is reduced.
- Output from the weighing platform should be within the range of ± 1.0 to ± 3.5 mV/V when loading up to weighing capacity. The power source of load cell is 5 V.
- Input sensitivity of load cell
Input sensitivity "X" of the load cell is as follows, given that rated output of the load cell is "A", its capacity is "B", and minimum display is "D".

$$X = \frac{5[V] \times A \times D}{B} \times 1000[\mu V]$$

Make input sensitivity "X" of the load cell to be 0.5 μV or greater.

With the example below, input sensitivity "X" of load cell is 1.5 μV.

- Rated output of load cell A 3 mV/V
- Capacity of load cell B 100 kg
- Minimum display D 0.01 kg

- To maintain good performance, keep the length of the load cell cable up to 5 m.

18.3. Separation of Display/GC-08

The display can be separated from the main scale. The length of cable between the display and the scale is approximately 1 m. With the GC-08 (extension cable), the length can be extended up to 2 m.

⚠ CAUTION

- If the operation is done with the weighing pan facing downward, excessive force will be placed on the scale, which may cause damage.
- To reattach the display after separating it, attach it to the main scale in the reverse order. In doing so, be careful not to get the cable caught between the devices.

18.3.1. Separation of Display

1. Remove the power source from the scale.
2. Loosen the four screws from the bottom of the base and remove the cover.
3. Loosen the four screws and remove the display and its securing sheet.

18.3.2. Attachment of GC-08

1. Remove the display (refer to “18.3.1. Separation of Display”).
2. Remove the cable clamp from the bottom of the base and remove the cable.
3. Open the cable panel of display and remove the connector. Squeeze the cable bush on the cable panel from both sides and remove it from the cable panel.
4. Attach the option cable (GC-08) together with the cable bush to the cable panel the same way as the standard cable.
5. Attach the connectors of the option cable (GC-08) to the display and the base respectively. After attaching the connector to the base, secure the base with cable clamp.
 - Firmly attach the connector in the correct direction. Poor connection may prevent accurate weighing.

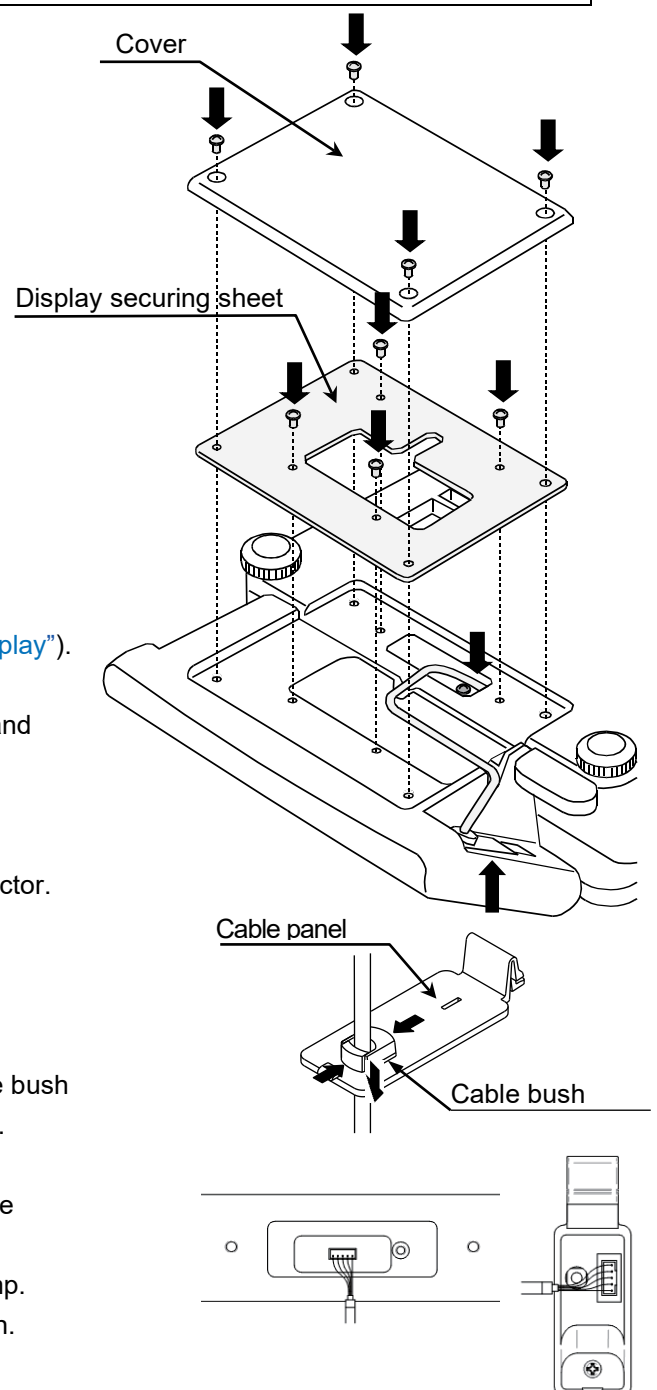



19. Maintenance

- Consider “4. Precautions for Use”.
- Regularly check that weighing can be properly performed, and perform sensitivity adjustment as needed. (refer to “13. Sensitivity Adjustment”).

19.1. Repair

Ask an A&D dealer for repair. Repair of the product must be performed by a qualified person only. Unauthorized repair is not covered by the warranty, and it may cause electric shock or damage.

19.2. Troubleshooting

Phenomenon	Confirmation item
The power is not turned on. Nothing is shown on the display.	<ul style="list-style-type: none"> □ Make sure that the power is correctly connected.
When the display is turned on, zero is not shown.	<ul style="list-style-type: none"> □ Check if there is something touching the weighing pan. □ Remove everything from the weighing pan. □ Perform sensitivity adjustment of the zero point (refer to “13.2. Sensitivity Adjustment Using a Weight”).
The display does not change.	<ul style="list-style-type: none"> □ Temporarily turn off the display.
The scale cannot count.	<ul style="list-style-type: none"> □ Check that the unit weight has been set (refer to “9. Counting”).

19.3. Error Display

Error display	Description and measures
	<p>The weighing value is unstable. As the weighing value is unstable, “zero display”, “sensitivity adjustment”, etc. cannot be performed.</p> <ul style="list-style-type: none"> □ Check if there is something touching the weighing pan. □ Avoid breezes or vibration. □ Perform sensitivity adjustment of the zero point (refer to “13.2. Sensitivity Adjustment Using a Weight”). □ Press the key to return to weighing display.
	<p>Error in entered value. The unit weight value or tare value entered exceeds the setting range. Re-enter the value within the setting range.</p>
	<p>The memory (storage circuit) is malfunctioning. Ask for repair.</p>
	<p>The voltage sensor is broken. Ask for repair.</p>
	<p>Error in weight sensor.</p> <ul style="list-style-type: none"> □ Check if the cable between the display and scale is properly connected. □ The weight sensor is malfunctioning.
	<p>Error in sensitivity adjustment. Sensitivity adjustment is canceled as the weight is too heavy or too light. Check the heaviness of the weight to retry sensitivity adjustment.</p>

Error display	Description and measures
<div style="border: 1px solid black; display: inline-block; padding: 2px 10px;">E</div>	<p>Excessive loading. The weighing value exceeded the weighing capacity. Remove everything from the weighing pan.</p>
<div style="border: 1px solid black; display: inline-block; padding: 2px 10px;">-E</div>	<p>Insufficient loading. The weighing value is too light. Check that the weighing pan is properly placed.</p>
<div style="border: 1px solid black; display: inline-block; padding: 2px 10px;">Lb</div>	<p>Low power. Power supply voltage is too low. Check the AC adapter or power in use.</p>
<div style="border: 1px solid black; display: inline-block; padding: 2px 10px;">Hb</div>	<p>High power. Power supply voltage is too high. Check the AC adapter or power in use.</p>

If the errors above persist or other types of error are shown, please contact A&D customer service.



20. Specifications

20.1. Specifications List

Model	GC-3K	GC-6K	GC-15K	GC-30K
Weighing capacity [kg]	3	6	15	30
Minimum display [kg]	0.0005	0.001	0.002	0.005
[g]	0.5	1	2	5
Weight unit	kg, g, lb, oz, ozt, pcs *3			
Number of samples	10 (5, 25, 50, 100, or arbitrary number is settable)			
Minimum countable unit weight [g] *1	0.1/0.005	0.2/0.01	0.4/0.02	1/0.05
Repeatability (Standard deviation) [kg]	0.0005	0.001	0.002	0.005
Linearity [kg]	± 0.0005	± 0.001	± 0.002	± 0.005
Required time for stability (under good environment)	Approximately 1.6 seconds (factory setting) Approximately 1.0 seconds (F04-02=0, F04-03=0)			
Span drift	±20 ppm/ typ. (5 °C to 35 °C)			
Operating temperature and humidity range	0 °C to 40 °C, 85 % RH or lower (no condensation observed)			
Display Count	7 segment LCD, character height 22.0 [mm]			
Weight	7 segment LCD, character height 12.5 [mm]			
Unit weight	5 x 7 dot LCD, character height 6.7 [mm]			
Icon	128 x 64 dot OLED			
Display refresh rate	Weight and count display: Approximately 10 times/second			
Interface	RS-232C microSD *2			
Power	AC adapter Supplied from mobile battery or USB port *2			
Weighing pan dimensions [mm]	300 x 210			
External dimensions [mm]	315(W) x 355(D) x 121(H)			
Main unit weight	Approximately 4.9 kg		Approximately 4.8 kg	Approximately 5.5 kg
Weight for sensitivity adjustment	3 kg±0.1 g	6 kg±0.2 g	15 kg±0.5 g	30 kg±1 g
Accessories	Quick start guide, AC adapter, USB cable			
Main material	ABS (display, base), polyester film (display sheet), SUS430 (weighing pan), aluminum die-cast (base)			

*1 Minimum countable unit weight can be selected in the function setting.

*2 Operation is not guaranteed with all devices.

*3 If the law in your area allows, you can use these units.

20.2. External Dimensions

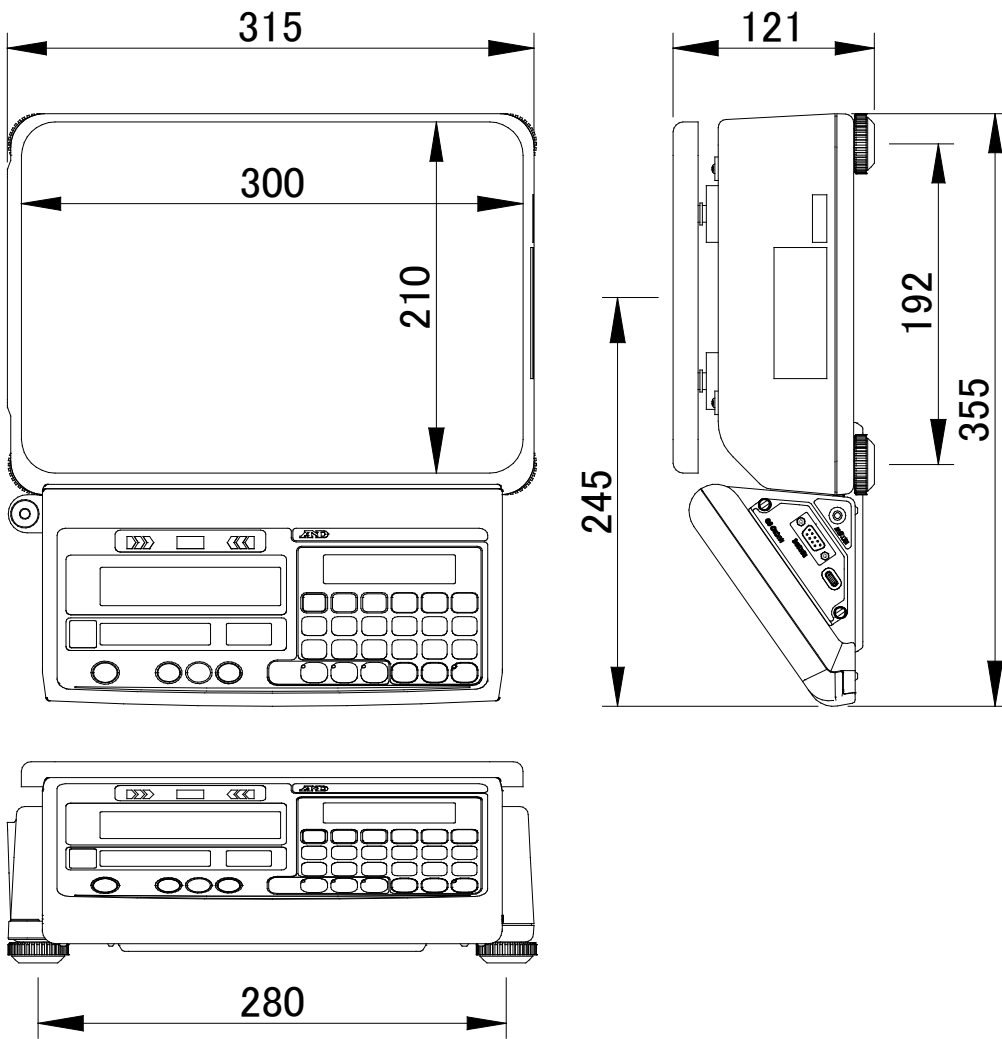

Unit: mm

20.3. Gravity Acceleration Map

Values of gravity at various locations

Amsterdam	9.813 m/s ²	Manila	9.784 m/s ²
Athens	9.800 m/s ²	Melbourne	9.800 m/s ²
Auckland NZ	9.799 m/s ²	Mexico City	9.786 m/s ²
Bangkok	9.783 m/s ²	Milan	9.807 m/s ²
Birmingham	9.813 m/s ²	Moscow	9.816 m/s ²
Brussels	9.811 m/s ²	New York	9.802 m/s ²
Buenos Aires	9.797 m/s ²	Oslo	9.819 m/s ²
Cape Town	9.796 m/s ²	Ottawa	9.807 m/s ²
Chicago	9.803 m/s ²	Paris	9.810 m/s ²
Copenhagen	9.816 m/s ²	Rio de Janeiro	9.788 m/s ²
Cyprus	9.797 m/s ²	Rome	9.803 m/s ²
Frankfurt	9.811 m/s ²	San Francisco	9.800 m/s ²
Glasgow	9.816 m/s ²	Singapore	9.780 m/s ²
Havana	9.788 m/s ²	Stockholm	9.819 m/s ²
Helsinki	9.819 m/s ²	Sydney	9.796 m/s ²
Jakarta	9.781 m/s ²	Taichung	9.789 m/s ²
Kolkata (Calcutta)	9.788 m/s ²	Taipei	9.790 m/s ²
Kuwait	9.793 m/s ²	Tokyo	9.798 m/s ²
Lisbon	9.801 m/s ²	Vancouver, BC	9.810 m/s ²
London (Greenwich)	9.812 m/s ²	Washington DC	9.801 m/s ²
Los Angeles	9.797 m/s ²	Wellington NZ	9.803 m/s ²
Madrid	9.802 m/s ²	Zurich	9.808 m/s ²

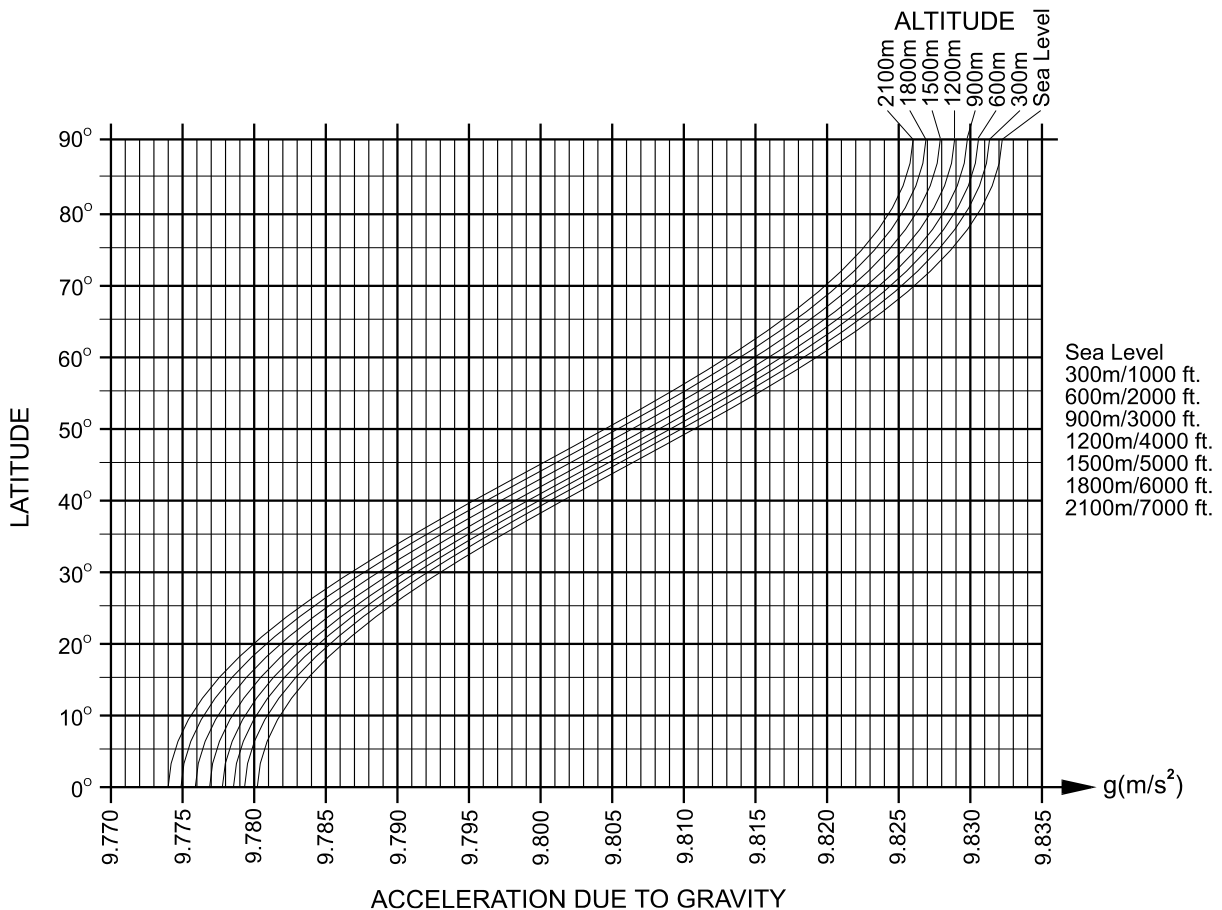

World map

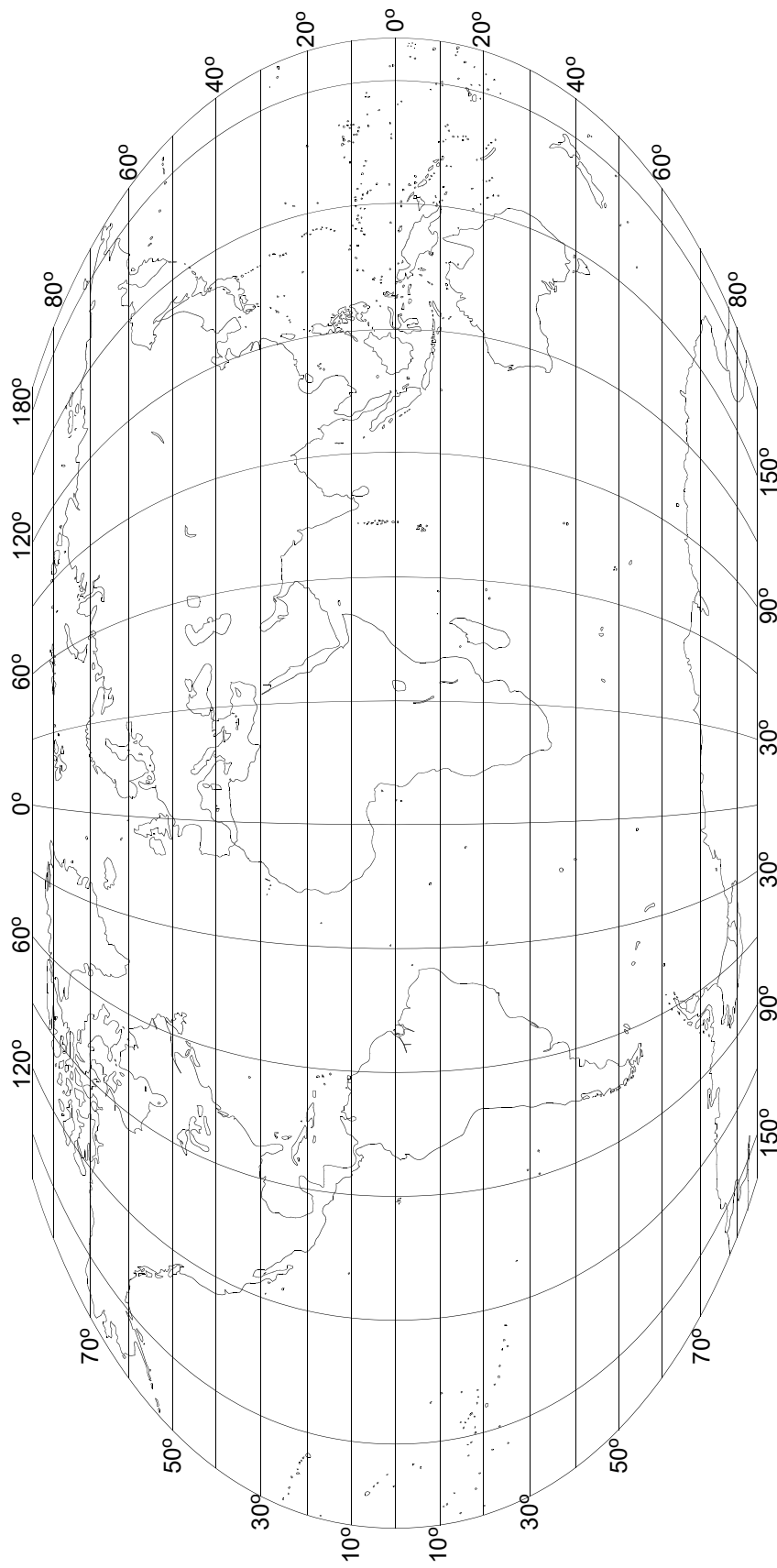

THIS PAGE INTENTIONALLY LEFT BLANK



A&D Company, Limited

3-23-14 Higashi-Ikebukuro, Toshima-ku, Tokyo 170-0013, JAPAN
Telephone: [81] (3) 5391-6132 Fax: [81] (3) 5391-1566

A&D ENGINEERING, INC.

47747 Warm Springs Blvd, Fremont, California 94539, U.S.A.
Tel: [1] (800) 726-3364 Weighing Support:[1] (888) 726-5931 Inspection Support:[1] (855) 332-8815

A&D INSTRUMENTS LIMITED

Unit 24/26 Blacklands Way, Abingdon Business Park, Abingdon, Oxfordshire OX14 1DY United Kingdom
Telephone: [44] (1235) 550420 Fax: [44] (1235) 550485

A&D AUSTRALASIA PTY LTD

32 Dew Street, Thebarton, South Australia 5031, AUSTRALIA
Telephone: [61] (8) 8301-8100 Fax: [61] (8) 8352-7409

A&D KOREA Limited

한국에이.엔.디(주)
서울특별시 영등포구 국제금융로6길33 (여의도동) 맨하탄빌딩 817 우편 번호 07331
(817, Manhattan Bldg., 33. Gukjegeumyung-ro 6-gil, Yeongdeungpo-gu, Seoul, 07331 Korea)
전화: [82] (2) 780-4101 팩스: [82] (2) 782-4264

OOO A&D RUS

ООО "ЭЙ энд ДИ РУС"
Почтовый адрес:121357, Российская Федерация, г.Москва, ул. Верейская, дом 17
Юридический адрес: 117545, Российская Федерация, г. Москва, ул. Дорожная, д.3, корп.6, комн. 86
(121357, Russian Federation, Moscow, Vereyskaya Street 17)
тел.: [7] (495) 937-33-44 факс: [7] (495) 937-55-66

A&D Instruments India Private Limited

ऐंडी इन्स्ट्रूमेंट्स इण्डिया प्रा० लिमिटेड
D-48, उद्योग विहार , फेस -5, गुडगांव - 122016, हरियाणा , भारत
(D-48, Udyog Vihar, Phase-V, Gurgaon - 122016, Haryana, India)
फोन : [91] (124) 4715555 फैक्स : [91] (124) 4715599

A&D SCIENTECH TAIWAN LIMITED. A&D台灣分公司 艾安得股份有限公司

台灣台北市中正區青島東路5號4樓
(4F No.5 Ching Tao East Road, Taipei Taiwan R.O.C.)
Tel : [886](02) 2322-4722 Fax : [886](02) 2392-1794

A&D INSTRUMENTS (THAILAND) LIMITED

บริษัท เอ แอนด์ ดี อินสตรูमेंท์ (ไทยแลนด์) จำกัด
168/16 หมู่ที่ 1 ตำบลรังสิต อำเภอธัญบุรี จังหวัดปทุมธานี 12110 ประเทศไทย
(168/16 Moo 1, Rangsit, Thanyaburi, Pathumthani 12110 Thailand)
Tel : [66] 20038911