

Operating Instructions

Sartorius Microwave Moisture Analyzer

Model LMA200PM

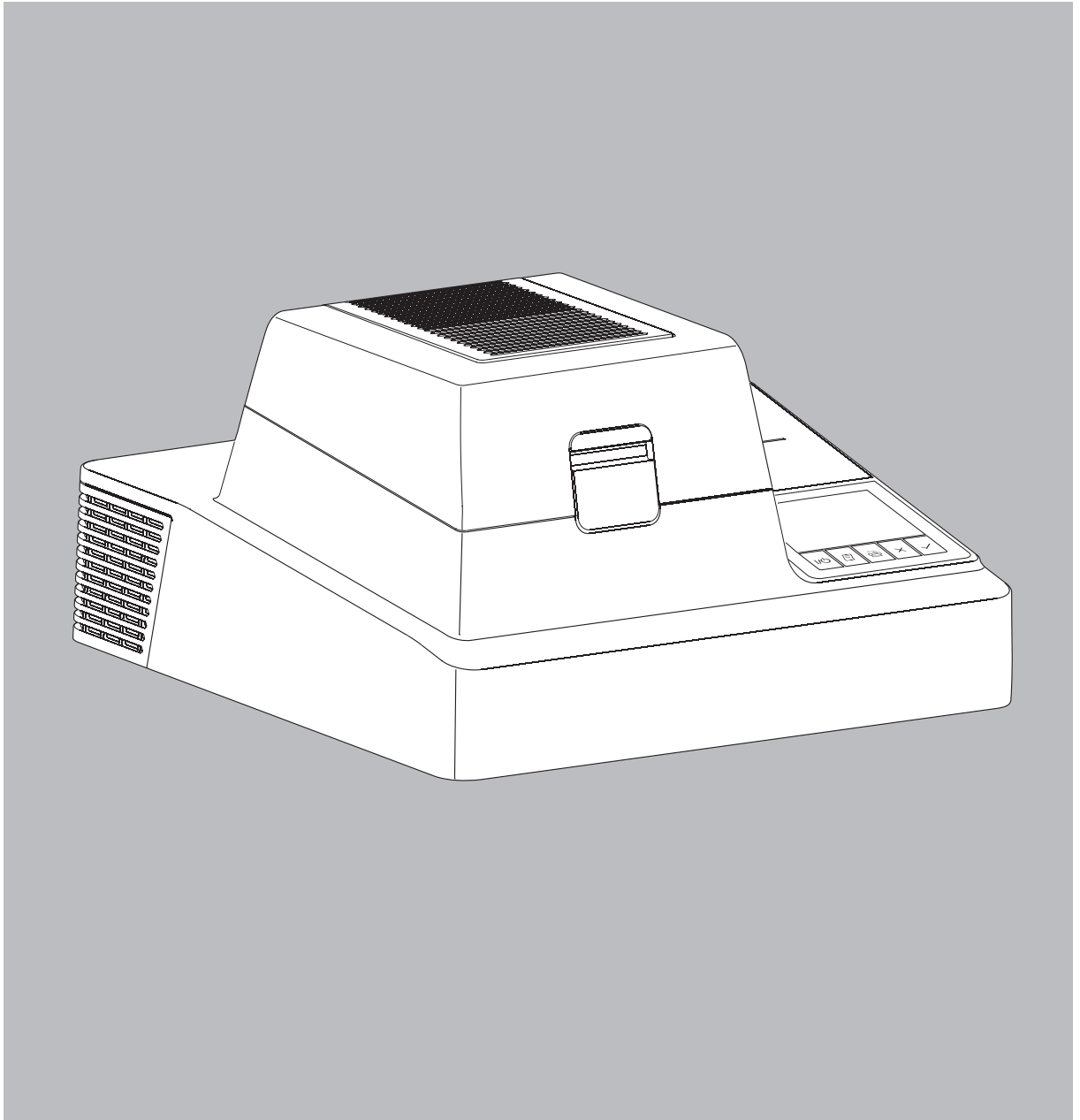

Intended Use

The LMA200PM laboratory moisture analyzer has been specially designed for fast moisture analysis of aqueous solutions with water contents of 8% to 100%.

Description of Functions

The sample is applied to a glass fiber pad and evenly heated using microwave technology, which causes the moisture in the sample to evaporate. The homogenous distribution of microwaves enables rapid drying of the sample. The drying stage of the procedure takes approximately 40 to 120 seconds.

The moisture content of the sample material is calculated from the weights of the sample before and after drying, which are measured by a built-in analytical weighing system. The loss-on-drying technique enables direct determination of the wet and dry weights.

A built-in, low-noise thermal printer records the results of analysis on a user-defined GLP-compliant printout.

The LMA200PM is a particularly rugged and easy-to-operate microwave analyzer that has the performance capability required for state-of-the-art laboratory tasks:

- Rugged and durable
- Easy to clean and disinfect

Symbols

The following symbols are used in these instructions:

- Instructions for proper operation
- Instructions for exceptional cases
- > The outcome of an operating step
- ⚠ Warning; hazard

Contents

Intended Use	2
Description of Functions.	2
Warnings and Safety Precautions	3
Safety Precautions	3
General View of the Moisture Analyzer	4
Getting Started	5
Storage and Shipping Conditions	5
Unpacking the Moisture Analyzer	5
Recycling the Packaging.	5
Equipment Supplied.	5
Conditioning the Moisture Analyzer	5
Installation.	5
Connecting the Moisture Analyzer to AC Power.	6
Switching on the LMA200PM	6
Operating Design	7
Keys and Display	7
Operation.	8
Output.	10
Configuration	11
Configuring Parameters in the Setup Menu.	13
Configuration Menu.	14
Overview of User Privileges.	15
Overview of Parameters in the Setup Menu	16
Operation	21
Setting the Drying Parameters.	21
Features.	23
Loading a Program.	23
Changing a Current Program	23
External Calibration/Adjustment.	27
Data Output Functions	28
Data Interfaces.	30
Saving Data	32
Troubleshooting Guide.	33
Inserting a Glass Fiber Pad	34
Removing a Glass Fiber Pad	34
Replacing the Printer Paper.	34
Care and Maintenance	35
Recycling.	35
Specifications	36
Accessories	36
Dimensions (Scale Drawings)	37
EC/EU Declaration of Conformity	38

Warnings and Safety Precautions

Safety Information

Note:

Read these operating instructions carefully before putting the LMA200PM into operation. Improper use or handling of the analyzer can result in damage and/or injury. The LMA200PM may be installed and operated by qualified personnel only. Make sure you observe the warnings and safety precautions in their entirety during installation and operation, as well as while performing maintenance and repair work on the equipment. The relevant laws, standards, regulations, guidelines and environmental protection provisions applicable in your country must also be observed. It is important that all personnel who operate the equipment understand these warnings and safety precautions, and have access to the relevant documents at all times. Furthermore, the warnings and safety precautions supplied with any electrical equipment connected, such as accessories, must be observed.

These warnings and safety precautions may have to be supplemented by the equipment operator. Make sure all operating personnel are informed of any additions to these instructions. Make sure the equipment is accessible at all times. If installation or operation is not performed in accordance with these instructions and acknowledged technical standards, all claims under the manufacturer's warranty are forfeited.

Warnings

- △ The LMA200PM weighs approximately 22 kg (48.4 lbs). Two people are required for transport and installation. Make sure to comply with the applicable safety regulations.
- △ Always disconnect the LMA200PM from power before moving it.
- △ Set up the LMA200PM on a stable, level, even surface.
- △ Do not operate the LMA200PM outdoors. Do not use this equipment in areas subject to safety hazards. If you use electrical equipment in installations and under ambient conditions subject to stricter safety standards than those described in this manual, you must comply with the provisions as specified in the applicable regulations for installation. Chemicals, including gases and dusts, that can corrode the inside or outside of the analyzer housing or cables must be kept away from the equipment.
 - The LMA200PM must not be exposed to strong electromagnetic fields (for example, through close proximity to cables carrying high electrical loads). Do not install the analyzer in an area in or near systems or equipment with magnetic materials.
 - Do not set up the LMA200PM near flammable materials or gas lines.
 - Do not expose the LMA200PM to aggressive chemical vapors or to extreme temperatures, moisture, shocks, or vibration.
- △ Refer to the chapter entitled "Specifications" for important technical data.
 - Make sure the place of installation is adequately ventilated to prevent build-up of excessive heat. Leave at least 20 cm (about 8 in.) space between the analyzer and the wall and about 1 m (3 ft.) above the analyzer. Make sure the cooling fans are always operational. In the event of defect, switch off the moisture analyzer and inform service personnel.

△ If you use cables purchased from another manufacturer, check the pin assignments in the cable against those specified by Sartorius before connecting the cable to Sartorius equipment, and disconnect any wires that are assigned differently. The braided shield in the cable must be made of metal and must provide at least 80% coverage. Both the plug and socket of all connections on the cable ends or in the equipment housing must have foil shielding that is suitable for high frequencies in accordance with CE regulations. The operator shall be solely responsible for any damage or injuries that occur when using cables not supplied by Sartorius.

△ Disconnect the LMA200PM from power (unplug it from the wall outlet) before opening the equipment housing and before connecting or disconnecting peripheral devices to or from the analyzer.

△ A power cord is included in delivery of your LMA200PM. In many European countries, the LMA200PM is electrically grounded by the power cord when it is plugged into the electrical socket (mains). If the mains power supply in your area does not have a grounding conductor, take the required measures to ensure that the analyzer is grounded. Disconnecting the ground conductor is prohibited.

△ If there is visible damage to the equipment or power cord, turn off the power and disconnect the equipment from AC power immediately. Lock the equipment in a secure place to ensure that it cannot be used for the time being.

△ The LMA200PM may be opened only by trained service technicians. Unplug the power cord from the wall socket (mains) before performing any work on the equipment.

△ Use only original Sartorius spare parts.

Safety Precautions

- △ Before switching on the analyzer, measures must be taken to prevent excessive exposure to microwave radiation:
 - Do not wedge any object between the analyzer cover and the sample chamber, as the cover provides a protective seal to limit electromagnetic emissions
 - Make sure the sample chamber is completely closed when the analyzer cover is lowered
 - Do not operate the moisture analyzer unless the cover, hinge, seal and safety lock are undamaged and fully functional
- △ Do not operate the LMA200PM with the cover open. Use of the moisture analyzer for anything other than its intended use as described by the manufacturer in this manual may impair the proper functioning of the analyzer's safety features and present a hazard for the operator.
 - The LMA200PM may be operated only by trained and qualified personnel.
- △ Do not use flammable, explosive, corrosive or polar solvents as sample materials. Do not perform moisture analysis on materials containing coal, graphite, or metal. Substances that contain poisonous or toxic components may only be dried if certain precautions are taken; for example, drying under a fume cover. The lower toxic limit stipulated for places of work must not be exceeded.

- △ Following moisture analysis, remove the sample with a forceps. Caution: the sample is still hot immediately following analysis. When analyzing samples that can be deemed hazardous, protective goggles, clothing and gloves must be worn when opening the analyzer cover after analysis. Some samples may form bubbles on the surface which can pop and splatter hot sample material when the sample is removed from the analyzer. In such cases, we recommend placing a second glass fiber pad on top of the sample before analysis. Exercise caution in selecting and preparing the sample in order to prevent operator injury or damage to the moisture analyzer.

Note:

Some sample materials, such as onion, may spontaneously ignite if the drying procedure continues after the sample has been completely dried. Make sure the equipment operator knows where the fire extinguisher is located. Moisture analysis can be stopped at any time by pressing the Cancel key (Back). The display then shows "Run canceled; remove sample".

- △ The safety lock and EMI-protective seal on the analyzer cover must not be manipulated or changed in such a way as to impair proper functioning. Do not wedge any object between the analyzer cover and the sample chamber, as the cover provides an EMI-protective seal.

- Do not place any objects or materials besides
 - Glass fiber pad
 - Sample retainer
 - Sample
 inside the sample chamber. Do not use a sample container that prevents the cover from closing completely.

- △ The moisture analyzer must not be operated if the sample chamber is not completely closed and sealed by the analyzer cover.

Safety Precautions

- △ Make sure the vents for the cooling fan and the analyzer cover are not blocked or covered, as this would distort the results of analysis.
- △ Make sure to avoid contamination of the sample chamber. The sealing surfaces where the cover meets the sample chamber, as well as the EMI-protective seal, must not be contaminated by sample material residues or other deposits. Keep the sample chamber clean at all times and remove any dirt or deposits immediately. Insert the protective plug (see "Getting Started") before cleaning. Do not use aggressive cleaning agents nor objects with sharp edges or points to clean the moisture analyzer. Follow the instructions under "Care and Maintenance" to clean your moisture analyzer.
- △ Make sure that no liquid enters the analyzer housing.

General View of the Moisture Analyzer

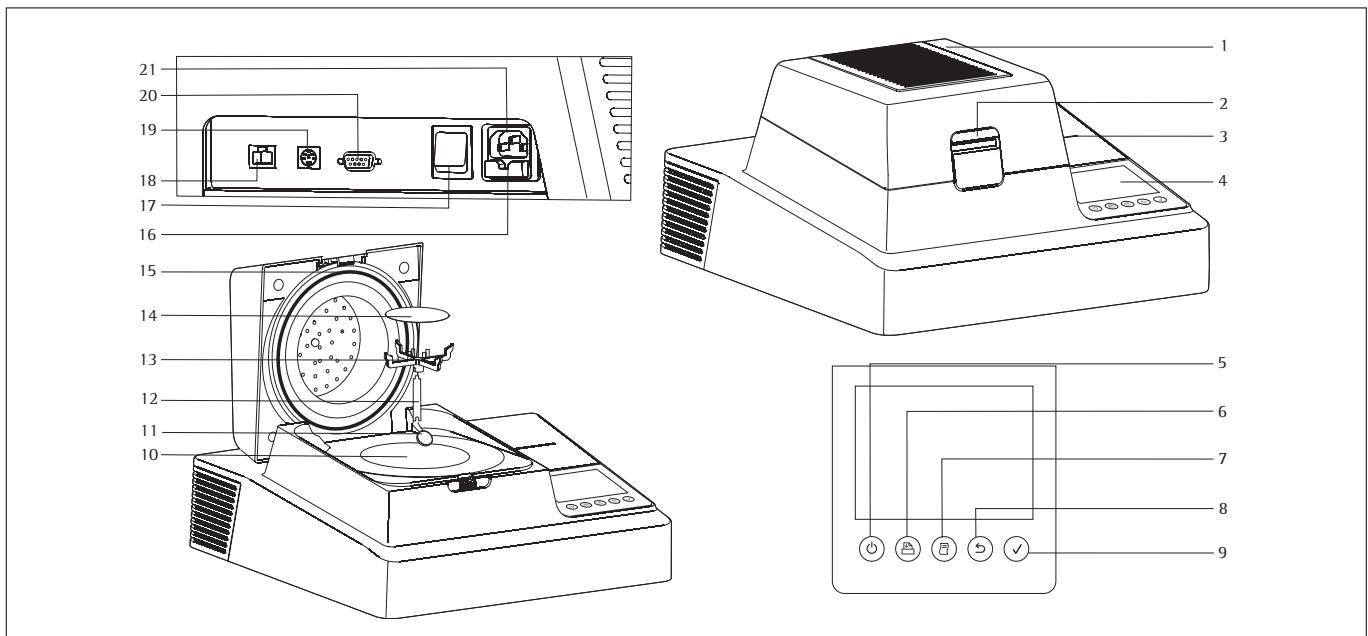

Pos.	Designation
1	LMA200PM
2	Safety lock
3	Printer/printer compartment
4	Touchscreen: 1/4 VGA display; 5.7" operating panel
5	⏻ On/off (standby) key
6	Ⓜ Form feed key
7	Ⓞ Print key
8	⏪ Cancel key (Back)
9	⏩ Enter key
10	Sample chamber

Pos.	Designation
11	Protective plug/transport locking device
12	Adapter
13	Sample retainer
14	Glass fiber pad
15	Analyzer cover with EMI-protective seal
16	Fuse (115V/230V)
17	Power switch (on/off)
18	Ethernet interface
19	PS/2 socket
20	RS-232 interface
21	AC jack

Getting Started

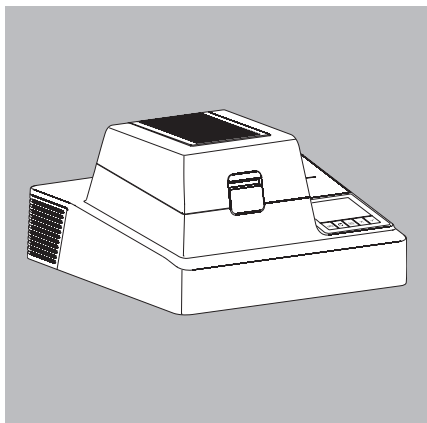

The LMA200PM moisture analyzer consists of magnetron, weighing module, display and control panel and printer. The moisture analyzer is powered over an external power cord. Furthermore, the analyzer has an Ethernet interface, an RS-232 interface and a PS/2 socket.

You can connect a computer over Ethernet, for example, or use the other ports to connect peripheral devices such as a keyboard or barcode scanner.

Storage and Shipping Conditions

- Allowable storage temperature: $-10\text{ }^{\circ}\text{C}$ to $+60\text{ }^{\circ}\text{C}$ ($14\text{ }^{\circ}\text{F}$ to $140\text{ }^{\circ}\text{F}$)
- Once the equipment has been removed from the packaging, it may lose accuracy if subjected to strong vibration. Excessively strong vibration may compromise the safety features of the equipment.
- To avoid injury, observe the warnings and safety precautions included in these instructions.

Unpacking the Moisture Analyzer

- After unpacking the moisture analyzer, check it immediately for any external signs of damage.
- If you detect any damage, proceed as directed under "Safety Inspection" in the chapter entitled "Care and Maintenance."
- Save the box and all parts of the packaging for any future transport. Coil the power cord prior to shipping. Disconnect all plug connections.

Recycling the Packaging

- Sartorius products are packaged to ensure safe shipment using environmentally friendly materials. After successful installation of the moisture analyzer, you can return this packaging for recycling as a valuable source of secondary raw material.

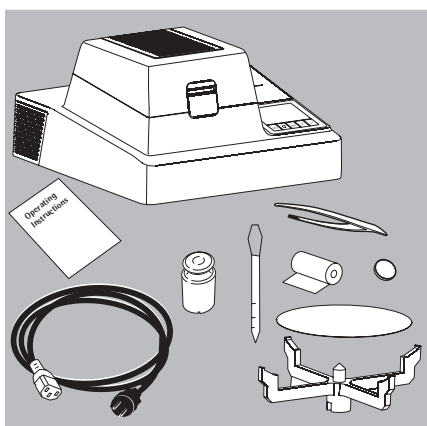

Equipment Supplied

- LMA200PM microwave moisture analyzer (model LMA200PM-000EU or LMA200PM-000US)
- Adapter with sample retainer
- Power cord
- Glass fiber pads (80)
- Printer paper (1 roll)
- Protective plug/transport locking device
- Blunt-tipped flat forceps
- 10 disposable pipettes
- Calibration weight (50 g, M1)
- Operating instructions (this manual)

Place of Installation

- Set up the analyzer on a stable, even surface that is not exposed to excessive vibration.
- Leave enough space around the analyzer to prevent build-up of heat.
- Keep the moisture analyzer accessible at all times.

Conditioning the Moisture Analyzer

Moisture in the air can condense on cold surfaces when ever the equipment is moved to a substantially warmer place. If you transfer the equipment to a warmer area, make sure to condition it for about 2 hours at room temperature, leaving it unplugged from AC power.

Installation

Read the section entitled "Warnings and Safety Precautions."

Choose a location that is not subject to the following negative influences:

- Heat (heater or direct sunlight)
- Drafts (i.e., from open windows and doors or from air conditioners)
- Vibration during analysis
- Excessive moisture

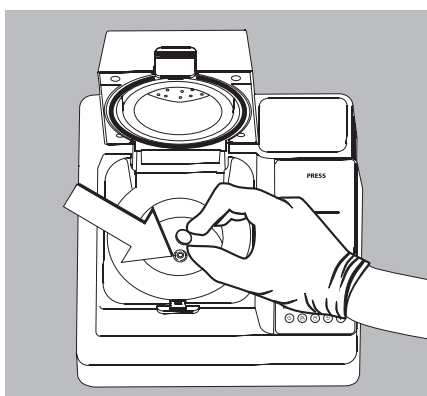

Setting up the Moisture Analyzer

- Open the cover.
- Remove the protective plug/transport locking device and keep it in a safe place.

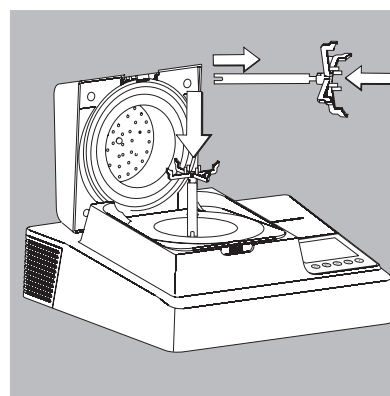

Installing the Sample Retainer

- Position the sample retainer on the adapter.
- Position the adapter with the sample retainer carefully on the weighing system. Turn the sample retainer slightly until it clicks into place.
- Close the cover. Make sure the safety lock is secure.

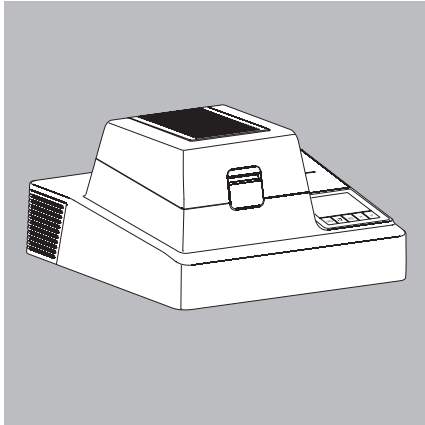

Power Connection

- Check the voltage rating and the plug design.
- Make sure that the voltage rating printed on the manufacturer's ID label is identical to that of your local line voltage. If the voltage specified on the label or the plug design of the AC adapter do not match your country's rating or standard, please contact the nearest Sartorius office or your equipment dealer. The power connection must be made in accordance with the regulations applicable in your country. The device (protection class 1) must be plugged into a properly installed wall outlet which has a protective grounding conductor (PE)

and a fuse with maximum 16A. The power plug or other suitable device for disconnecting the power must be easily accessible so the LMA200PM can be disconnected quickly in case of hazard.

Safety Precautions

If you use an electrical outlet that does not have a protective grounding conductor, make sure to have an equivalent protective conductor installed by a certified electrician as specified in the applicable regulations for installation in your country. Make sure the protective grounding effect is not neutralized by use of an extension cord that lacks a protective grounding conductor.

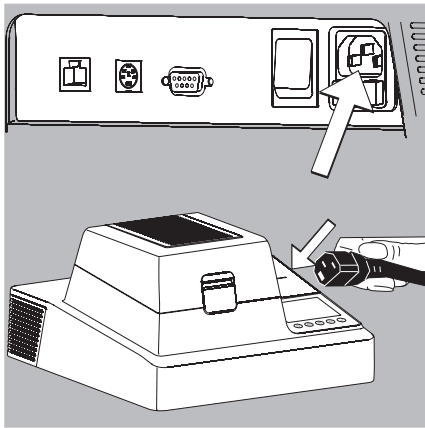

Connecting the Analyzer to AC Power

Note:

The heating unit of the moisture analyzer has been factory-set to 230 V or 120V, depending on the information given in your order. The voltage setting is indicated on the manufacturer's label; for example:

- 230 volts: LMA200PM-...EU
- 115 volts: LMA200PM-...US
- ⚠ If the voltage setting is not correct, do not operate the moisture analyzer! The equipment must be modified by a Sartorius service technician.
- Use only original power cords approved by Sartorius or by a trained electrician.

If the cable supplied with the AC adapter is not long enough, make sure to use an extension cord that has a grounding conductor. If you use an electrical outlet that does not have a protective grounding conductor, make sure to have an equivalent protective conductor installed by a certified electrician as specified in the applicable regulations for installation in your country. Make sure the protective grounding effect is not neutralized by use of an extension cord that lacks a protective grounding conductor.

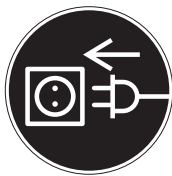

Connecting the Power Cord

- Plug the power cord into a wall outlet (mains) that has been installed in accordance with industry standards and is equipped with a protective ground (earth) conductor (PE).

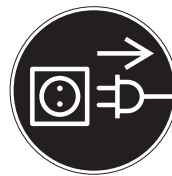

Connecting Electronic Peripheral Devices

- Make absolutely sure to unplug the scale from AC power before you connect or disconnect a peripheral device (printer, scanner or PC) to or from the interface port.

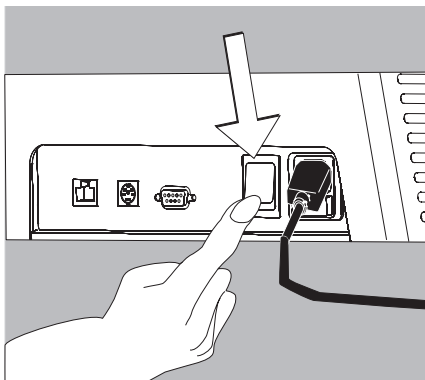

Switching on the LMA200PM

- Press the on/off switch (17) to switch on the moisture analyzer.

Equipment not in Use

If the equipment will remain unused for only a short period, press the ⏻ key (5) to switch it to standby mode.

If it will remain unused for a long period, use the on/off switch (17) to switch it off.

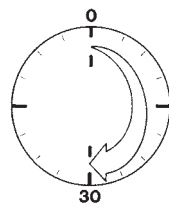

Warmup Time

To deliver exact results, the weighing system in the LMA200PM moisture analyzer must warm up for at least 30 minutes after initial connection to AC power or after a relatively long power outage. Only after this time will the system have reached the required operating temperature.

Operating Design

Operation of the LMA200PM follows a standardized “philosophy” which is described below.





Keys and Display

The moisture analyzer is operated using either the keys and the touchscreen, or using an optional PC keyboard. This manual describes operation using the analyzer’s keys and display.

Keys below the Display

These keys always have the function indicated by the label, but the functions might not be available at all times. Whether a function is available at a given time depends on the operating state of the analyzer and the menu settings active at that time.

Key Meaning

-  On/off
Switches the moisture analyzer on or off.
When using this key, as opposed to the power switch on the side of the analyzer, “off” sets the analyzer to standby mode.
-  Form feed
Advances the paper in the printer by one line.
-  Print
Sends the displayed value or selected data record to the built-in printer and, depending on your configurations, over the data interface.
-  Back
During measurement:
Cancels the active function
Navigating the menu:
Returns to previous menu level
During input: Cancels input
-  Confirm
During measurement:
Activates the selected function
Navigating the menu:
Shows next menu level
During input: Saves input

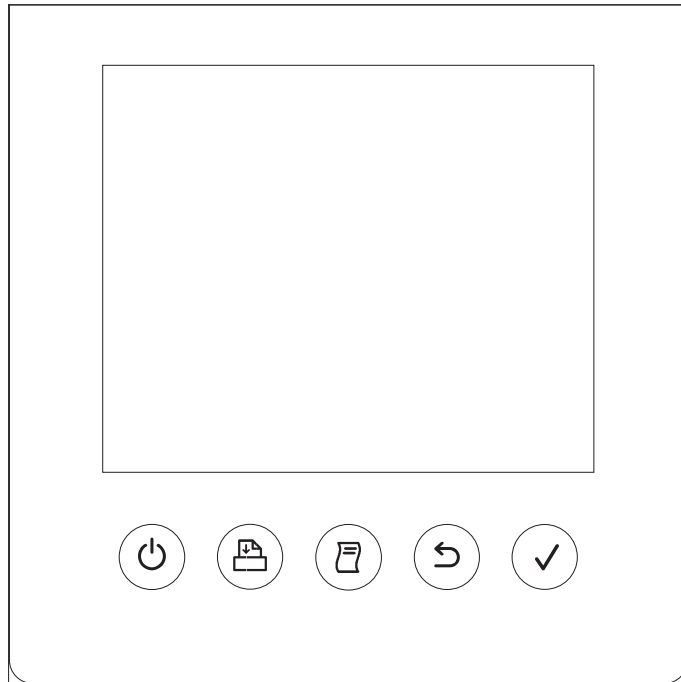

Touchscreen display

The display is sensitive to touch, and is used for both input and output (display).

Input Through the Touchscreen



The display shows five large buttons along the bottom of the screen. Texts or graphic symbols (such as arrows) indicate the function of these buttons at any given point. The main window, for example, may show the following buttons:



When navigating the Setup menu the following buttons may be shown:



You can select a menu item, such as a particular application program, by tapping the corresponding menu line on the display.

For alphanumerical input, the touchscreen shows a keypad. Tap the desired characters and then press the  key to confirm, or  to cancel.

Data Output on the Display

There are six fundamentally different types of display:

- Analysis and test functions
- Menu parameter settings (e.g. Setup or Program menu)
- Input
- Printer configuration
- Database functions
- Messages (e.g., information, warnings, prompts to save, etc.)

Operation

Analysis and Test Functions

The display (shown here on the right) is divided into six areas. These are named in the list at the far right, and described in detail below.

Info line:

This line shows the following:

- User name
- Date and time

Bar graph:

This line shows a checkweighing bar graph shown (upper illustration) or a net-weight bar graph (middle illustration).

The latter shows absolute values (in the example, 0 to 70 g) while the former shows a target weight (setpoint) and upper and lower tolerance values (user-definable).

The checkweighing bar graph is shown if **Setpt./tolerance** or **Minimum/maximum** is set for the initial weight. The net-weight bar graph is shown if **OFF** is set for the initial weight. During analysis, this line shows a scale of 0 to 100% as well as the percentage of solids in the initial weight (lower illustration).

Measured value/result line:

This line shows the weight readout (with the weight unit, at stability) or a calculated value, a plus or minus sign, and the weight unit displayed.

Text lines:

The text lines show details on the selected program; for example, the program name (short form), detection method and drying process.

Prompt/activity line:

This line shows either of the following:

- An operator prompt (middle illustration): white characters on green background.
- A message on the current status or activity of the moisture analyzer (lower illustration): red characters on yellow background.

Touchscreen keys:

Up to five keys are depicted at the bottom of the screen for operation of the analyzer or screen navigation (for example, the arrows in the lower illustration).

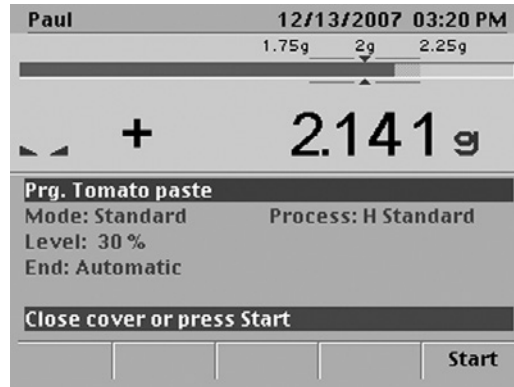

Info line

Bar graph line (in this example: checkweighing bar graph)

Measured value line

Text line 1

Text line 2

Text line 3

Text line 4

Text line 5

Prompt (green) / Status (yellow)

Touchscreen buttons

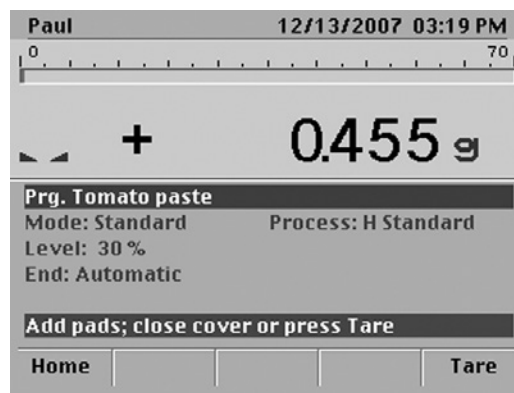

Prompt:

white characters on green background

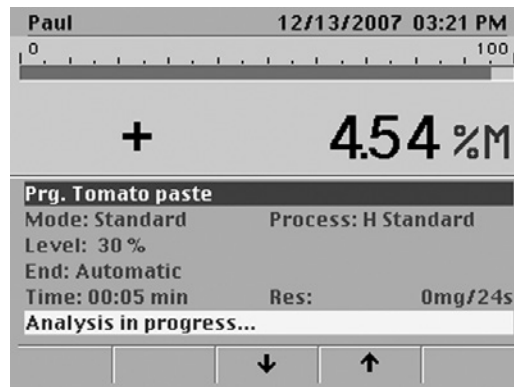

Status:

red characters on yellow background

Menu Operation

The operating menu display is divided into three areas (see illustration on the right):



Status line:

The status line indicates the source of the information displayed, in a format similar to a directory path.

Menu lines:

These show the menu items that can be selected. A right-arrow is shown to the left of each item.

Touchscreen keys:

You can select a menu item by tapping in on the display, or by tapping the arrows buttons as needed to move the highlight bar and pressing  to confirm. Press the  key to return to the next higher menu level.

Note:

Menu lines shown in gray cannot be selected.

Input

The selection of a menu item often opens an window for entering or editing data, using one of two methods:



- by selecting a value from a list
 - by entering letters, digits, and/or special characters using the touchscreen keypad
- Touchscreen keys and menu items shown in gray are inactive.

Selecting a value from a list

If there are multiple values to choose from, the  symbol is shown on the far left-hand side of the input field.

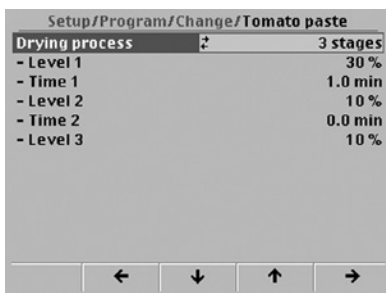
Example: defining the drying process:



- To select the next value in the list:
 - Tap the "Drying process" item, or
 - Tap the touchscreen button in the lower right-hand corner (i.e., the arrow pointing towards the right )
- To select the previous value in the list:
 - Tap the second touchscreen button from the left (the arrow pointing towards the left )

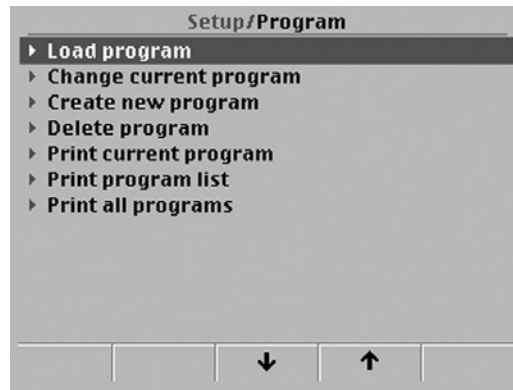

Status line
Menu line 1
Menu line 2
Menu line 3
Menu line 4
Menu line 5
Menu line 6
Menu line 7

Additional menu lines (depending on menu and status)

Touchscreen buttons

Entering data using the touchscreen keypad

If no  is shown, the value can be entered or edited using the touchscreen keypad.



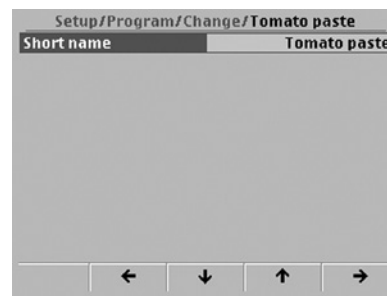

Example: defining the short form of a program name:

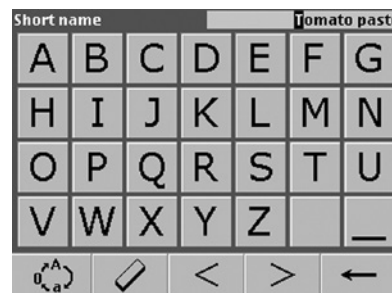

- Select "Short name:"
 - Tap the "Short name" item, or
 - Press 
- > The touchscreen keypad is displayed



The touchscreen pad always shows capital letters when it is first opened. When you switch to numerical input (see below), numbers and special characters are shown.



-  Switch input from upper-case letters to numbers and special characters to lower case letters
-  Delete the selected character (i.e., the character in the cursor position; inversely displayed)
-  Move the cursor one position to the left
-  Move the cursor one position to the right
-  Delete the character to the left of the cursor

If you do not move the cursor before beginning input, the existing value is deleted.

The remaining characters are entered in overwrite mode; i.e., in the cursor position.

- Once you have completed input of characters:
 - Press  to confirm your input, or
 - Press  to cancel any changes in the value.

Database Functions

The LMA200PM moisture analyzer has three databases:

- Program database
- Results database
- User database

Program Database

All drying programs and all parameters for each drying program are stored in this database.

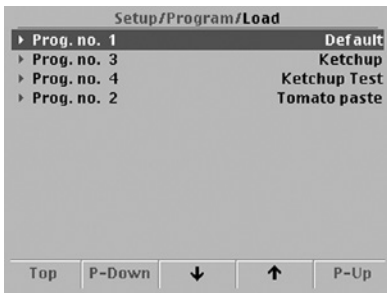

Results Database

Analysis results can be selected, displayed, printed and statistically evaluated. A menu lists all analysis runs. Each menu item has two lines:

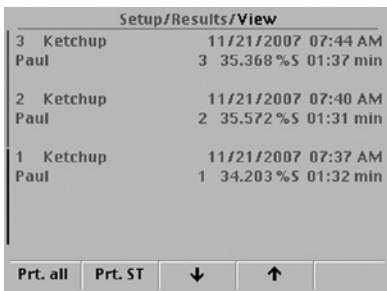

User Database

This database stores all users with the associated data, such as user group and PIN.

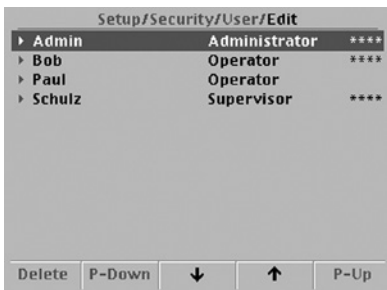

Messages

Messages are displayed at the time the event triggering the message occurs (on top of the analyzer display). Some messages contain touchscreen buttons. There are several types of message:

Question

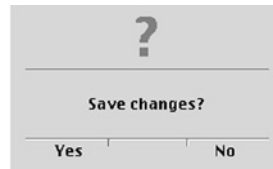

A question mark indicates options for continued operation. Tap the touchscreen button of your choice.

Stop



The Stop message is shown when an important operation cannot be executed. Tap "OK" to confirm and close the message.

Processing



The clock symbol indicates that an action is in progress.

Warning



Information text



Confirmation of execution

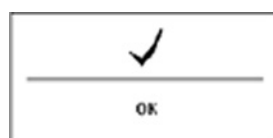

Output

The following options are available for data output (see also "General View of the Moisture Analyzer" on page 4):

- Built-in printer
- Ethernet interface
- RS-232 interface

Built-in Printer

You can configure printer settings and printout formats, including settings for ISO/GLP-conformant records. ISO: International Organization for Standardization
GLP: Good Laboratory Practice

See "Data Output Functions" in the chapter entitled "Operation" for details.

Ethernet Interface

The moisture analyzer can communicate over the Ethernet interface and an Internet browser using virtual network computing (VNC).

See "Data Output Functions" in the chapter entitled "Operation" for details.

RS-232 COM Port

Measured values and data records can be output over this interface with the same layout format used by the built-in printer.

See "Data Output Functions" in the chapter entitled "Operation" for details.

Input

The following option is available for input (see also "General View of the Moisture Analyzer" on page 4):

- PS/2 interface for keyboard or barcode scanner

PS/2 Interface

You can connect a PC keyboard with a PS/2 male connector (35 mA) to the PS/2 port on the moisture analyzer. Operation through the PC keyboard is analogous to use of the analyzer's touchscreen keypad. Alternatively, you can connect a barcode scanner to the PS/2 port.

See "Data Output Functions" in the chapter entitled "Operation" for details.

Configuration

Purpose

You can configure your LMA200PM moisture analyzer to meet individual requirements by entering user data and setting selected menu parameters in the Setup menu.

With the default settings, parts of the Setup menu are accessible only to certain user groups, as indicated in parentheses in the following list.

The Setup menu is divided into the following sections:

- Manage programs (administrators, supervisors)
- Evaluation of results
- Configuration (administrators, supervisors)
- Calibration (administrators)
- Security management (administrator rights)
- Info



Setting the Language

You can choose from 5 languages for printouts and display:

- English
- German
- French
- Italian
- Spanish



Example: Changing the language setting

Prerequisite: Administrator or supervisor rights

Step	Key (or instruction)	Display/output
1. Login as administrator	<p>Tap the Login button</p> <p>Subsequent login: list of all users Tap the "Administrator" line</p> <p>Tap the [name] PIN line Enter your PIN. First login: 9999 Press  to confirm</p>	<p>First login: Admin Administrator ****</p> <p>First login: Admin: PIN *****</p> <p>Subsequent login: [Name]: PIN *****</p>
2. Select the Setup menu	Tap the Setup line	<p>With administrator rights: Manage programs Evaluation of results Configuration Calibration Security management Info</p> <p>With supervisor rights (applies only if privileges have not been changed): Manage programs Evaluation of results Configuration Info</p>
3. Open the list of language options	<p>Tap the Configuration menu item</p> <p>Tap the Device menu item</p> <p>Tap the Operating parameters line</p>	Setup/Configuration/Device/Operation Operating language English
4. Select the desired language	Tap the Operating language line repeatedly until the desired language is shown (in this example, German)	Bediensprache Deutsch
5. Exit the Operating Parameters menu	Press the  key	
6. Edit other settings	Tap the Yes (or Ja) button in the message window	
7. Close the Setup menu	Press the  key 3 times	

Example: Defining a new user (Name: Jones) and access controls for the "Supervisor" user group

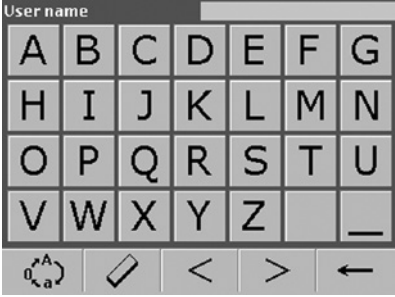
Prerequisite: Administrator rights

Step	Key (or instruction)	Display/output
1. Open the Setup menu	Tap the Setup line	With: administrator rights: Manage programs Evaluation of results Configuration Calibration Security management Info
2. Open the User Name input window	Select the following menu items: Security management Modify user data Configure new user	
3. Enter the new user name and confirm your input	Tap the required letters, numbers, or special characters (in this example: Jones) and press the ✓ key	User Jones Group Operator PIN *
4. Select the "Supervisor" group	Tap the ➡ button and press the ✓ key	Group Supervisor
5. Open the "PIN" input window	Tap the ⬇ button and press the ✓ key	
6. Enter the PIN and confirm	Tap your choice of 4 digits (in this example: 1234) Press the ✓ key	
7. Enter the same PIN again and confirm	1234 and press the ✓ key	
8. Exit this menu level	Press the ⊖ key	Save changes? Yes/No
9. Save changes	Tap the Yes button	
10. Select "Access control, supervisor" (settings are applied to all "Supervisors")	Tap the ⬇ button and press the ✓ key	
11. Define the desired access rights and switch rights on or off	Tap the ⬇ or ⬆ buttons as needed and press the ✓ key	
12. Save changes	Press the ⊖ key Tap the Yes button	
13. Close the Setup menu	Press the ⊖ key 3 times	

Selection: Program name “Ketchup” (all datasets with the drying program called “Ketchup”)

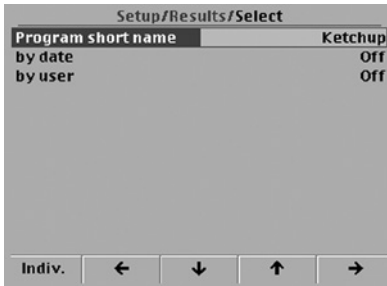

Selection: Program name “Ketchup” plus date and user name

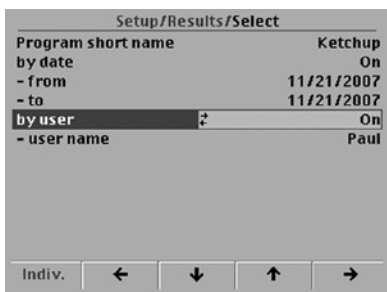

Selection: Short name “Ketchup” plus selection of individual datasets from a list of datasets with the “Ketchup” drying program

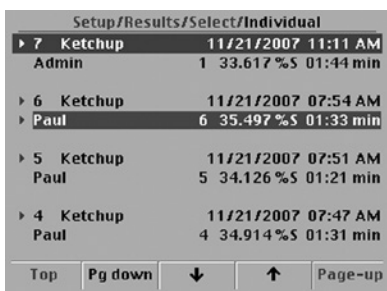

In this example, the second line of dataset 6, with the user name “Paul,” has been selected for statistical evaluation and thus is highlighted in green.

Selecting Individual Datasets

- Configuration under “Setup/Results/Select:”
 - Set “by date” to **Off**
 - Set “by user” to **Off**
- To enable individual selection of datasets:
 - Tap the **Indiv.** button
- To select an individual dataset:
 - Tap the first line of the desired dataset
- To confirm the selection and highlight the dataset: Press the **⊙** key

Configuration

The parameters in the “Configuration” menu are grouped as follows:

- Device
- Results*
- Print parameters*
- Print formats*

Device:

You can enter or modify data affecting the following areas of LMA200PM operation:

- Date and time*
- Serial interfaces*
 - Built-in printer
 - RS-232 interface
- Ethernet*
 - Device name
 - DHCP
 - IP address
 - Subnet mask
 - Standard gateway
 - Remote access for VNC client
- Operating parameters*
 - Operating language
 - PS/2 keyboard
 - Keyclick duration
- Display settings*
 - Color scheme
 - Brightness
- Weighing module settings*
 - Filter adaptation

Results*:

You can set the following parameters for results:

- Sample ID
- Evaluation of results

Print Parameters*:

You can set the following parameters for printing:

- Automatic printing
- Headers 1 to 3

Print formats*:

You can set the following parameters for printing data records and statistics:

- Data record header
- Data record intermediate results
- Data record footer
- Statistics printout

The chapter entitled “Overview of Parameters in the Setup Menu” shows a tree diagram of the values that can be selected or entered for the parameters described above.

Calibration*

When you select “Cal./adj. weighing module” and then “External/adjustment” the display shows the following:

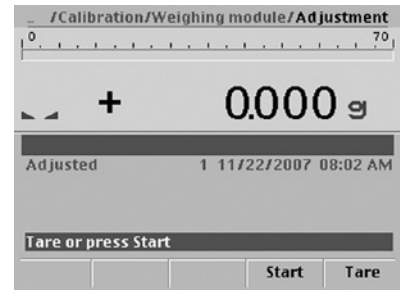

For details, see “Calibration and External Adjustment” in the chapter entitled “Operation.”

Security management*

The parameters in the “Security management” menu are grouped as follows:

- Modify user data
- Restore factory settings
- Additional configurations

Modify user data:

You can configure the following:

- Modify user data:
 - You can assign group membership, with the associated user privileges, and a new PIN to any user except the administrator that has the user name “Admin.”
- Delete any user except “Admin”
- Configure new user
 - You can set up a new user account by defining name, group and PIN.
- Access rights, supervisor
 - Select this option to define which of the following parameters can be edited by users with supervisor rights:
 - SET Calibration
 - SET Manage programs
 - SET Eval. of results
 - SET Print param.
 - SET Printout formats
 - SET Date and time
 - SET Serial interface
 - SET Ethernet
 - SET Operating parameters
 - SET Display settings
 - SET Weighing module settings
- User privileges, operator:
 - Select this option to define which parameters can be edited by users with operator rights. The parameters available for selection are the same as those listed above for defining supervisor rights.

* Access rights required

Restore factory settings:

You can restore factory settings separately for any of the following areas:

- Program database
All drying programs are deleted. One program, called "Default" (short name), is created with the factory-default parameters.
- Results database
All results are deleted.
- User database
All user accounts are deleted. One user, called "Admin," is created in the Administrator group with the PIN "9999."
- Printing options:
All printing parameters and printout options are reset to the factory defaults.
- Device configuration
The following parameters are reset:
 - Format for display and printout of date and time
 - Built-in printer
 - Function of the RS-232 interface
 The following parameters are not reset:
 - Clock
 - RS-232 data interface parameters
 - Ethernet network parameters
 - Operating parameters (language, PS/2 keyboard, keyclick duration)
 - Display

Additional configurations:

You can configure the following:

- Info line for starting screen
The text you enter here (up to 50 characters) is displayed directly below the weight readout in the initial display. If you do not enter any text here, none is shown in the initial display.
- Maximum magnetron temperature
You can enter a temperature from 50 °C to 80 °C. No analysis can be performed if this temperature is exceeded. If you tap the **Analys** button while this function is blocking analysis, the message "Cooling down" is displayed until the analyzer has returned to operating temperature.

Info

Shows information about the LMA200PM, the weighing module and the databases.

- To print an informational screen:
Press the **Print** key.

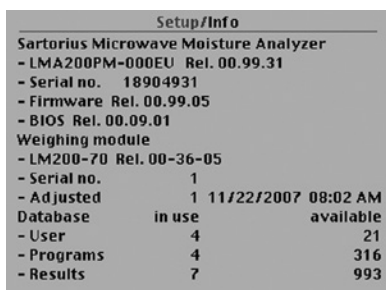

Overview of User Privileges

Group	Administrator	Supervisor	Operator	Operator with PIN=0
SETUP Security management	(+)	(-)	(-)	(-)
User login/logout	(+)	(+)	(+)	(+)
SETUP Manage programs	+	+	-	-
Call programs	(+)	(+)	(+)	(+)
Perform moisture analysis	(+)	(+)	(+)	(+)
SETUP Evaluate results	(+)	(+)	(+)	(+)
SETUP Info	(+)	(+)	(+)	(+)
SETUP Calibration	+	-	-	(-)
SETUP Configuration				
DEVICE Date and time	+	+	-	(-)
DEVICE Serial interfaces	+	+	-	(-)
DEVICE Ethernet	+	-	-	(-)
DEVICE Operating parameters	+	+	-	(-)
DEVICE Display settings	+	+	+	(-)
Results	+	+	-	(-)
Print Parameters	+	+	-	(-)
Print formats	+	+	-	(-)
Weighing module settings	+	+	-	(-)

- +: Permitted
- (+): Always permitted; cannot be modified
- : Not permitted
- (-): Not permitted; cannot be modified

Notes:

- Users with operator privileges and PIN=0 can run the permitted functions without entering a PIN. Login is solely for identification purposes in documentation of results.
- The user account with the name "Admin" in the Administrator group cannot be deleted. We recommend changing the PIN for this user account so that it no longer uses the factory-set PIN listed in this manual.
- Administrators can configure access controls for the Supervisor and Operator groups.
- If you forget the administrator PIN, tap the "Service" touchscreen button. This generates a random number; contact the Sartorius service hotline to receive the temporary PIN assigned to this number.
- Tap the Logout touchscreen button and enter your PIN to log out. A message opens to confirm logout.
- Users are logged out automatically if the LMA200PM is disconnected from power. Pressing the on/off key to set the analyzer in standby mode does not log the user off.

Overview of Parameters in the Setup Menu

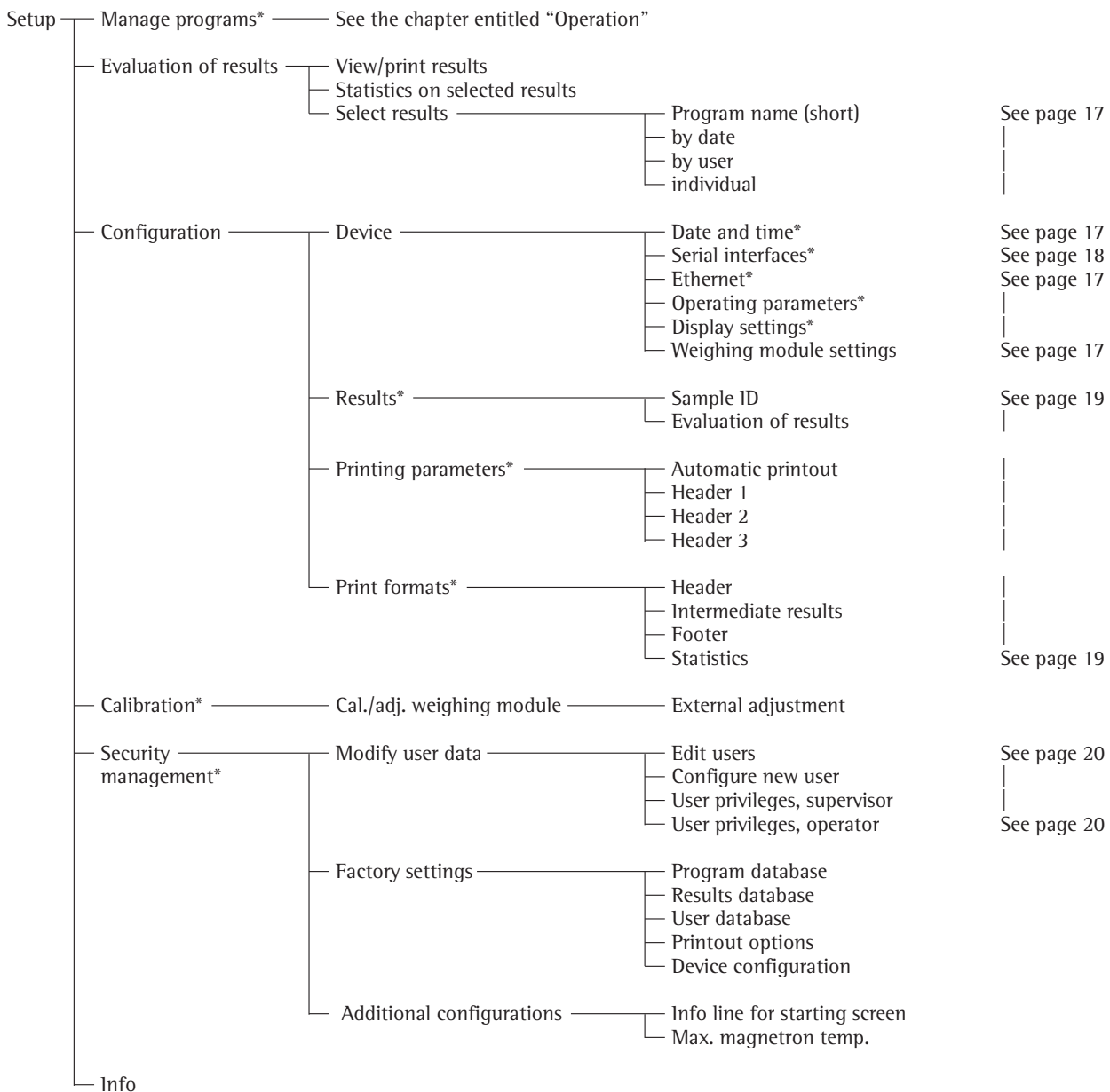

* Access rights required

Parameters in the Setup Menu

Evaluation of results - Select results;
Configuration - Device

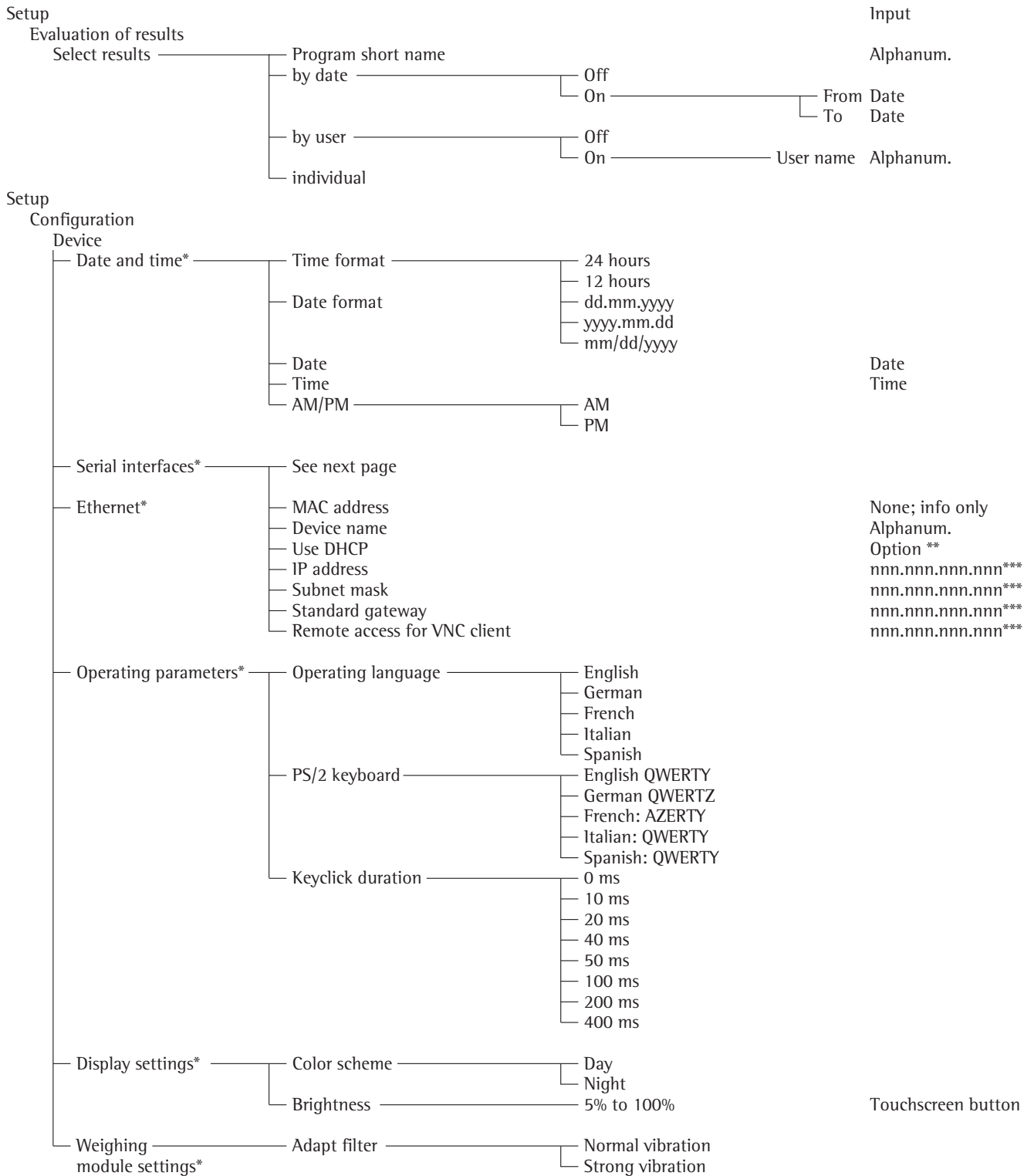

*Access rights required

**Activate only if necessary

*** nnn is a number between 0 and 255

Parameters in the Setup Menu

Configuration - Results
Configuration - Printing parameters
Configuration - Print formats

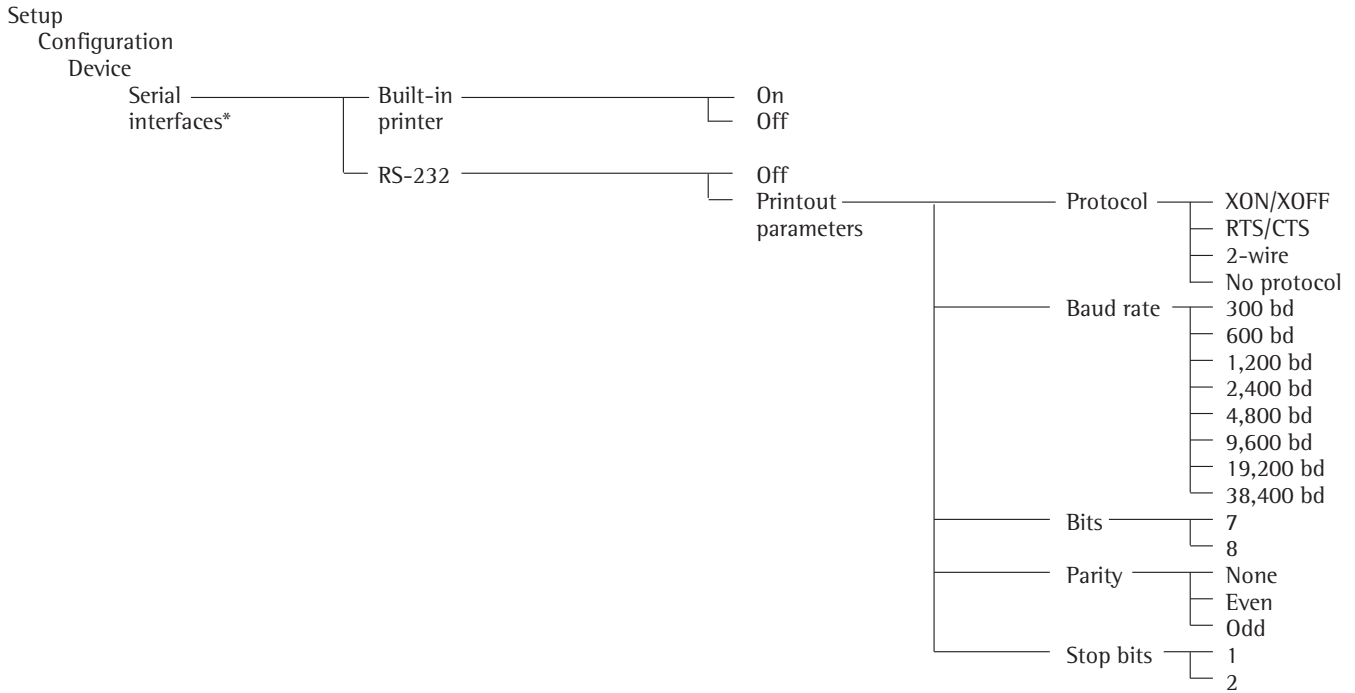

*Access rights required

Parameters in the Setup Menu

Configuration - Results

Configuration - Printing parameters

Configuration - Print formats

Setup

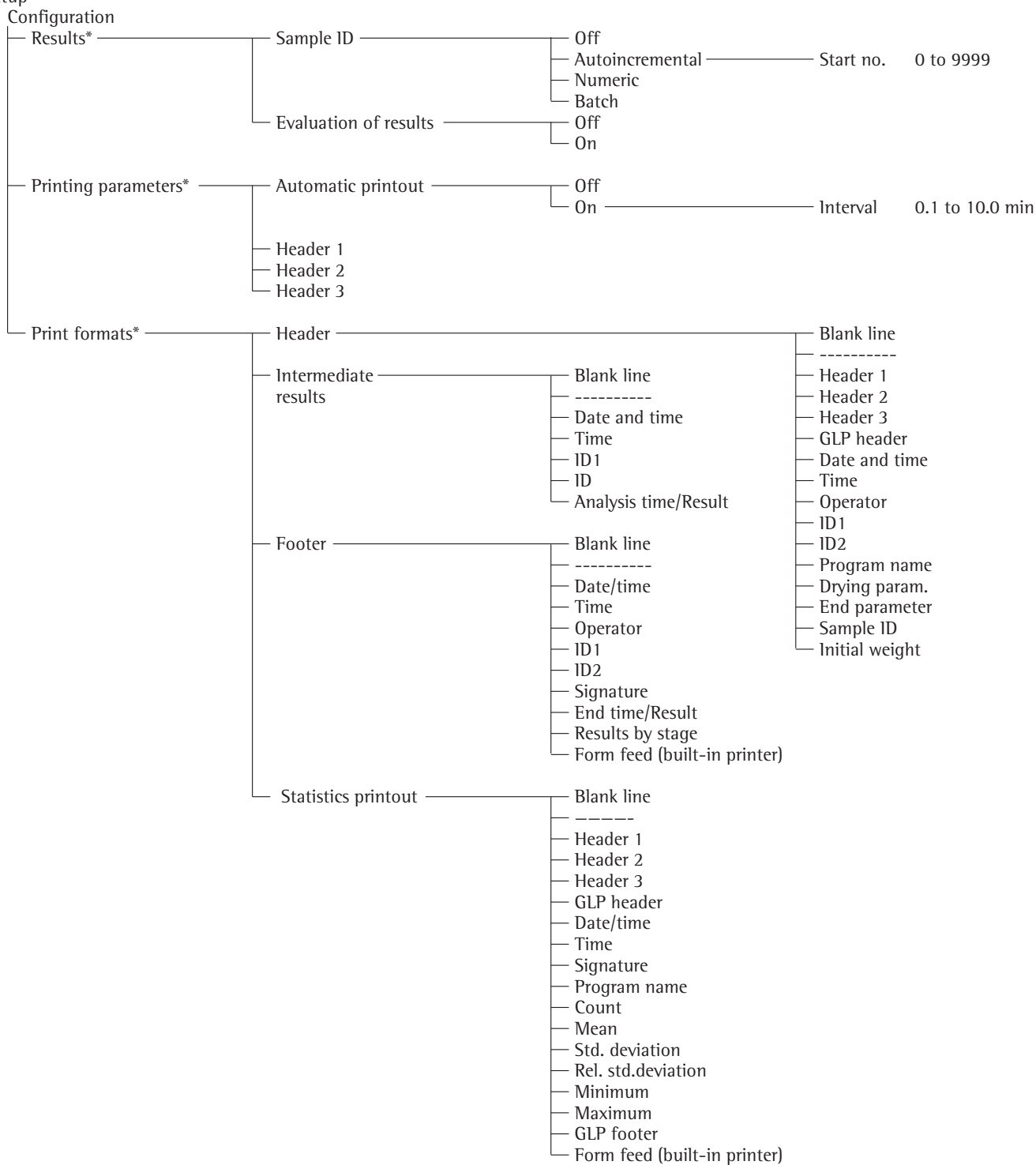

* Access rights required

Parameters in the Setup Menu

Security management - Modify user data

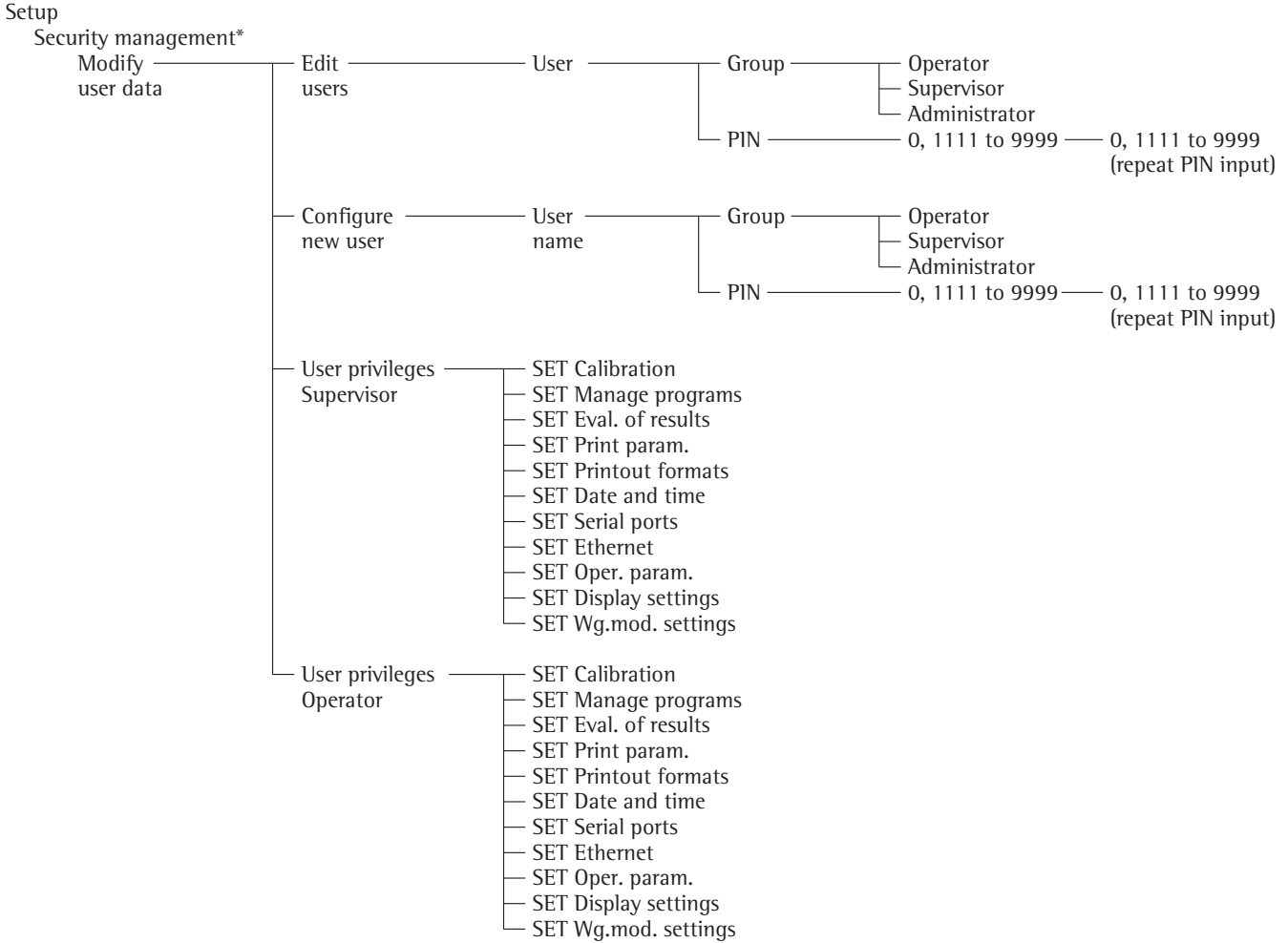

* Access rights required

Operation

Setting the Drying Parameters

Purpose

Adapt the moisture analyzer's software to the special requirements of products. Parameters can be configured individually for each program.

Drying Parameters (Overview)

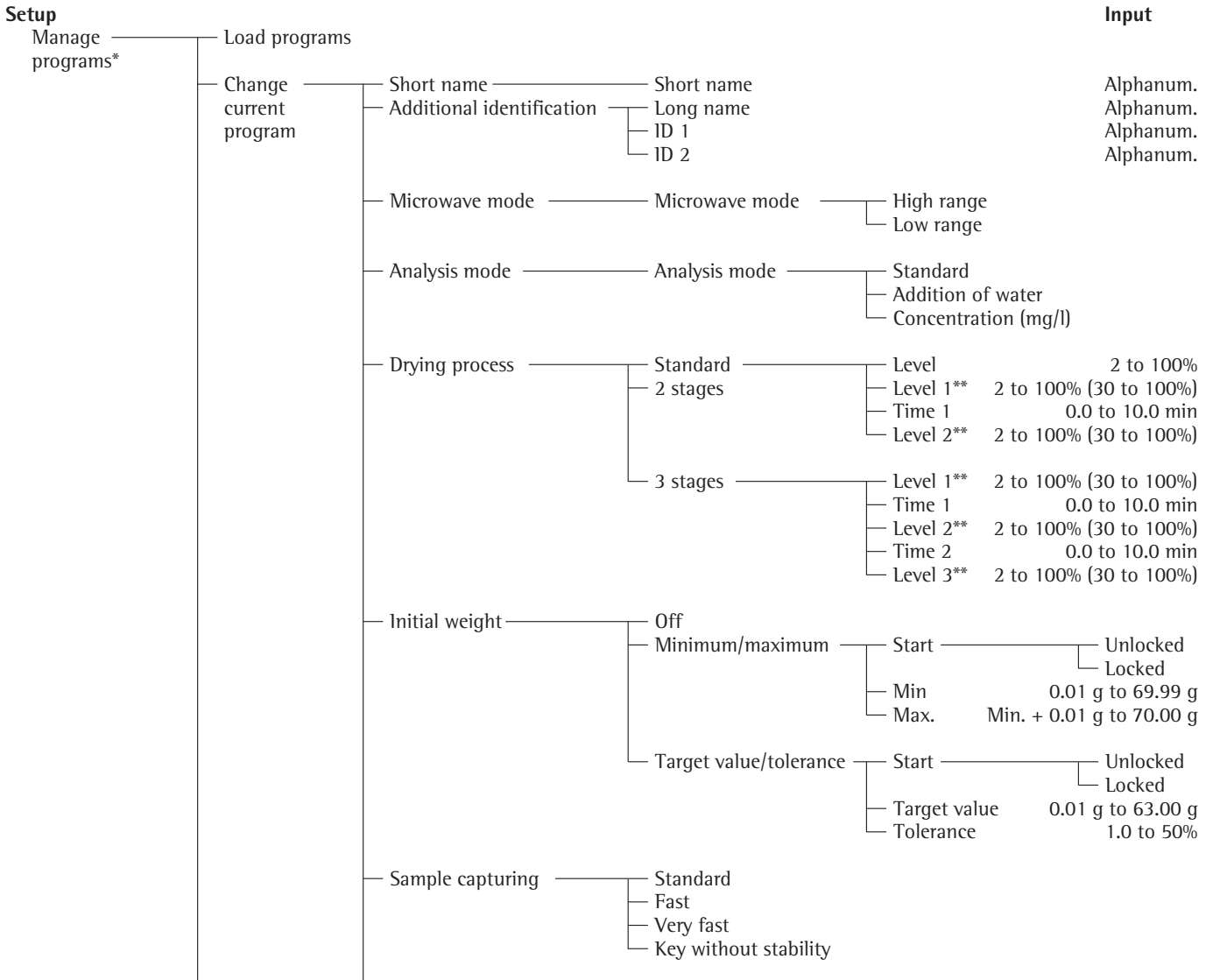

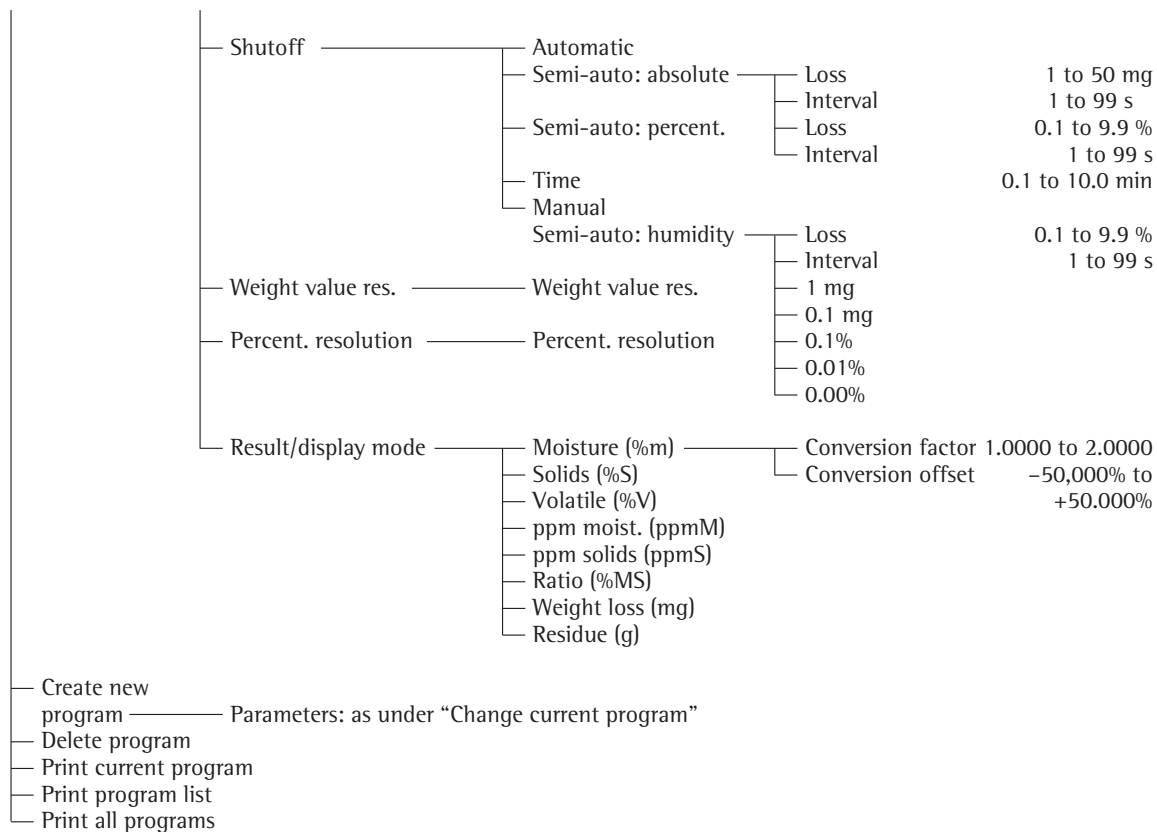

* Access rights required

** Range of options for Levels 1, 2, 3 depends on "Microwave mode" setting:

High range: 2% to 100 %; Low range: 30% to 100% (low range is the factory default)

Features

Load programs*

The program database in the LMA200PM can store up to 320 drying programs. To view a list of available programs, sorted alphabetically by short name, select Setup > Manage programs > Load program.

Change current program*

Short name, Long name

You can designate both a short name (up to 15 characters) and a long name (up to 20 characters) for each program. Each short name must be unique in the database.

ID1, ID2

You can assign 2 identifiers (up to 20 characters each) for each program.

Microwave mode

There are two modes to choose from for operation of the microwave:

- High range (2% - 100%)
- Low range (30% - 100%), roughly 10% - 30% of the maximum microwave output. We recommend using the low range mode as a rule.

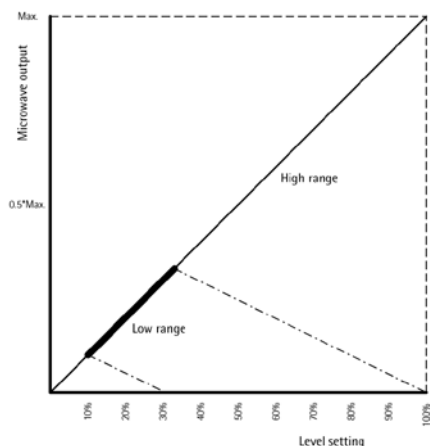

Analysis mode

There are three modes to choose from for analysis:

- Standard
- Addition of water
- Concentrate

Standard

Most analyses are performed using this method.

Addition of water

When the sample is heated by microwave radiation, dipolar molecules, such as water molecules, in the sample absorb the radiated energy.

Relatively dry samples – with a moisture content below 10% – contain few dipolar molecules. Thus it takes longer to heat the sample. Adding distilled water to the sample has a catalytic effect, in that the energy from the microwave radiation is absorbed faster, causing the sample to heat up more quickly.

Note:

The added distilled water evaporates completely during the drying process and does not distort the results of moisture analysis.

Concentration

The LMA200PM can analyze only small volume samples. If the proportion of solids for a larger volume is sought, the “Concentrate” function is used.

Example:

A 5-ml sample is taken from 1 liter of waste water. Before starting the analysis, the user enters “1000 ml” as the initial volume. The moisture analyzer multiplies the proportion of solids detected by a factor of 200 (1000 ml: 5 ml). The result is the proportion of solids in 1000 ml of the sample material.

Drying process

The drying process can be divided into stages, with different microwave output in each stage.

Note:

The time of the last stage is the determined by the shutoff parameter in all drying processes.

- Standard:
The microwave output remains constant throughout the entire drying process.
- 2 stages:
The drying process is divided into two stages, with different levels of microwave output in each stage. You can configure a period of 0.0 to 10.0 minutes for first stage.
- 3 stages:
The drying process is divided into three stages, with different levels of microwave output in each stage. You can configure periods of 0.0 to 10.0 minutes for the first and second stages.

Initial weight

You can define conditions for the initial weight that must be met before the analysis can start:

- Off:
No conditions are defined for the initial weight
- Minimum/maximum:
The initial weight must be greater than the defined minimum weight and less than the defined maximum weight. If “Locked” is set under “Start,” analysis cannot be performed if the initial weight is not between the minimum and maximum values. If “Unlocked” is set, the minimum and maximum values are merely guidelines.
- Setpoint/tolerance limits:
You can define a target weight (setpoint) and associated tolerance limits for the initial weight. In this case, the initial weight must be greater than the setpoint minus tolerance and less than the setpoint plus tolerance. If “Locked” is set under “Start,” analysis cannot be performed if the initial weight is not within the tolerance limits. If “Unlocked” is set, the setpoint and tolerance values are merely guidelines.

Sample capturing

The speed at which the balance registers weights and transfers data during initial weighing can be adapted to the particular sample being analyzed:

- Standard
- Fast
- Very fast
- Key w/o stability

Standard:

For normal samples and normal handling;

Fast:

For samples that must be applied quickly, or if you require a relatively exact weight toward a target;

Very fast:

For samples containing slightly volatile components;

Key w/o stability:

The balance performs as under the “very fast” option;
For samples with volatile constituents, such as hairspray:
Spray sample on pan, wait 1–2 sec. (spray pressure)

* Access rights required

Shutoff

You can choose from a variety of modes for ending the analysis:

- Automatic
- Semi-automatic, absolute
- Semi-automatic, percentage
- Timer mode
- Manual
- Semi-automatic, humidity

Automatic:

The analysis ends as soon as the weight loss is below a particular threshold which is determined during the analysis.

Semi-automatic, absolute:

The analysis ends as soon as the weight loss per defined time (1 to 99 s) is lower than a user-defined threshold.

The threshold is defined as an absolute value (1 to 50 mg).

Semi-automatic, percentage:

The analysis ends as soon as the weight loss per defined time (1 to 99 s) is lower than a user-defined threshold.

The threshold is defined as a percentage of the initial weight (0.1 to 9.9 %).

Timer mode:

The analysis ends as soon as the specified time has elapsed.

Manual:

The analysis ends when the user presses the \odot key.

Semi-automatic, humidity:

The analysis ends when the humidity sensor detects a moisture loss over a user-defined time period that is below a particular threshold. The threshold (loss) is defined as a percentage (0.1 to 9.9% humidity).

Weight value resolution

You can choose from the following for resolution of the weight value:

- 1 mg
- 0.1 mg

Percentage resolution

You can choose from the following for percentage resolution of the result:

- 0.1 %
- 0.01 %
- 0.001 %

Result/display mode

The following units can be selected for displaying analysis results:

- Moisture (%M)
- Dry weight (%S)
- Volatile (%V)
- Moisture/solids (%M/S)
- ppm moist. (ppmM)
- ppm solids (ppmS)
- Ratio (%MS)
- Weight loss (mg)
- Residue (g)

You can define the following for the "Moisture" (%M) and "Dry weight (%S)" display modes:

- Conversion factor
- Conversion offset

If one of these parameters has been changed, the unit is displayed with an asterisk (%M* or %S*).

Note:

These options are not available for the "Concentrate" mode.

The unit of measurement displayed for "Concentrate" is mg/l.

Create new program*

When you create a new program you can choose from the same parameters as those available under "Change current program" (see above). When you store the new program, it is automatically loaded and becomes the current program.

Delete program*

You can delete any drying program.

Print program*

The following options are available:

- List of all programs: as shown under Setup > Manage programs > Load program (prog. no. and short name); see sample printout below.
- Current program as shown under Setup > Manage programs > Change current program; see sample printout below.
- All programs with all parameters

Sample Printout: List of All Programs

Program list

```
Prog. no. 3 Butter
Prog. no. 2 Rye flour
Prog. no. 1 Caro wheat flour
```

Sample Printout: Current Program

```
Short name      Caro wheat flour
Long name      KWS genetically mod.
ID 1           ID12
ID 2           19999666
Microwave mode Low range
Analysis mode  Standard
Drying process 3 stages
- Level 1      50%
- Time 1       1.0 min
- Level 2      20 %
- Time 2       0.5 min
- Level 3      10 %
Initial weight  Setpoint/
tolerance
- Start        Locked
- Nom.         30.00 g
- Tolerance    10.00%
Shutoff        Semi-auto: absolute
- Loss         2 mg
- Interval     10 s
Weight value res. 1 mg
Percent. resolution 0.1%
Result/display mode Moisture (%M)
- Conversion factor 1.0000
- Conversion offset 0.000 %
```

*Access rights required

Example: Determining the moisture content of ketchup

Prerequisite: Program: "Ketchup" with following settings: Mode: Standard, Process: Standard, Level: 30%, End: Automatic

Step	Key (or instruction)	Display/output
1. Switch on the LMA200PM	Press the power switch on the right-hand side of the analyzer	
2. Open the list of programs	Tap the LoadPrg button	A list such as the following opens: <pre> Program/Load Prog. no. 1 Tomato paste Prog. no. 2 Ketchup Prog. no. 3 Butter </pre>
3. Select the "Ketchup" program	Tap the Prog. no. 2 line	Message window shows a question: <pre> ? Load "Ketchup Yes No </pre>
4. Confirm selection of "Ketchup" program	Tap the Yes button	A message window with information is shown briefly: <pre> i Loading... </pre> <p>The display's info line shows: LMA200PM Rel.01.00.00 Prg.Ketchup</p> <p style="text-align: right;">28.11.2007 14:41:38</p> <pre> + 0.000 g Prg.Ketchup Mode: Standard Process: R Standard Level: 30% End: Automatic </pre> <p>Open the hood Home</p>
5. Begin moisture analysis	Tap the Analyze button	
6. Tare the weighing module	Raise the analyzer hood	Prompt (on green background): Add pad; close cover or press Tare Touchscreen keys: Home Tare
7. Place pad on sample retainer Pasty and creamy samples – such as ketchup – form bubbles when they are heated, which can pop and splatter hot sample material. This can be prevented by placing a second pad on top of the sample.	Place second pad on sample	
8. Tare the weighing module	Close the hood	The status line (yellow background) briefly shows the following: Taring the weighing module... Afterwards a prompt is shown: Open cover

Step	Key (or instruction)	Display/output
9. Open the hinged cover	Open the LMA200PM Remove the pads	Prompt (green background): Add sample to pad
10. Add sample	Trickle ketchup onto glass fiber pad Spread ketchup evenly Place the second pad on the ketchup	
11. Insert sample	Place pads with ketchup on the sample retainer	If the sample weight is within the tolerance limits: An acoustic signal (beep) is emitted The bar graph is green Close cover or press Start If the sample weight is not within tolerance limits: No acoustic signal is emitted The bar graph is orange or red
Change sample amount as needed	Remove some ketchup from the pad, or add more ketchup	
12. Continue analysis	Close the analyzer cover	The status line briefly shows the following: Determining initial weight value... The header is printed. Example: ----- 28.11.2007 16:41:46 Sartorius Microwave Moisture Analyzer LMA200PM-000EU Rel. 01.00.00 Serial no. 12345678 ----- Prg. Ketchup Mode: Standard Process: R Standard Level: 30 % End: Automatic Initial weight: + 2.125 g ----- During analysis, the status line shows the following (yellow background): Analysis in progress... At the end of analysis, the status line briefly shows the following (yellow background): Determining final weight... The analysis result is printed. Example: ----- 00:40 + 0.752 g + 64.63 %M ----- After the end of analysis, the prompt line shows the following (green background): Run completed; remove sample The bar graph line shows the percentage of solids in the initial weight. The measured value line shows, for example: Moisture + 64.63 %M
13. Remove the sample	Raise the analyzer cover Remove the pads with the sample.	The cooling fan continues to run. The cooling fan shuts off automatically.
14. Begin next analysis	Tap the Analyze button	Continue from Step 4 above. Cooling fans switch off.
15. End the analysis series.	Press the ⊖ key	Starting screen

Example: Calibration and external adjustment of the weighing module

Prerequisite: Login with user privileges (with the default settings, administrator rights are required; see table on page 15).

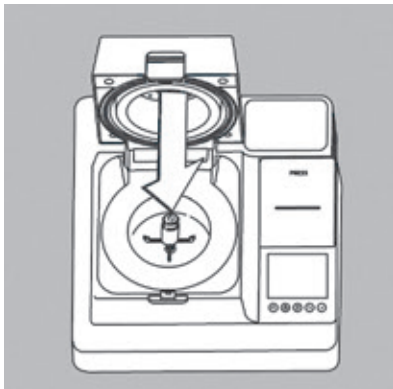
Step	Key (or instruction)	Display/output
1. Switch on the LMA200PM	Press the power switch on the right-hand side of the analyzer	
2. Login as Administrator	Tap the Login button Tap the display line showing "Administrator" privileges Tap the line showing [Name]: PIN Enter your PIN and confirm by pressing ✓	
3. Activate external adjustment	Tap the Setup button Tap the Calibration line Tap the Cal./adj. weighing module line Tap the External adjustment line	Prompt line (green background): Tare or press start Touchscreen keys: Start Tare
4. Make sure there is no load on the weighing module	Remove any pad or sample from the sample retainer	
5. Tare the weighing module	Tap the Tare button	Status line (yellow background): Taring the weighing module...
6. Calibrate the weighing module	Tap the Start button	The status line briefly shows the following (yellow background): Initialing... Afterwards the prompt line (green background) shows: Add weight
7. Position the calibration weight	Place the 50-g calibration weight on the sample retainer 	The info line shows: Weight is in tolerance Status line (yellow background): Adjustment in progress... At the conclusion of adjustment: Message window Adjusted The calibration record is printed: ----- 28.11.2007 17:41:46 Sartorius Microwave Moisture Analyzer LMA200PM-000EU Rel. 01.00.00 Serial no. 12345678 ----- External adjustment W-ID Nom. + 50.000 g Diff. + 0.002 g External adjustment Diff. + 0.000 g Completed -----
8. End calibration/adjustment	Remove the calibration weight Close the cover Press the ⊙ key	Signature

Data Output Functions

In addition to the data interfaces (see the chapter entitled Data Interfaces”), the LMA200PM offers the following output options:

- LMA200PM display
- Built-in printer

LMA200PM Display (Weights and Calculated Values)

The display is divided into 6 sections. Information about the weighing module, the application in use and the sample is output in these sections as follows:

- Info line
- Bar graph
- Measured value/result line with stability symbol
- Text lines
- Prompt/status line
- Touchscreen buttons
- Message windows that are shown briefly and cover other areas of the display

Info line

This line shows the following information:

- User name
- Date and time

Bar graph

The bar graph is shown during weighing and acts as a user guide. During analysis, a scale from 0 to 100% is displayed, as is the proportion of solids in the initial weight. The bar graph can show absolute values (net weights) or checkweighing values.

- Net-weight graph: If the **Off** setting is selected for the “Initial weight” parameter in the Setup menu (under “Change current program” or “Create new program”), the bar graph shows absolute values (0 to 70 g).

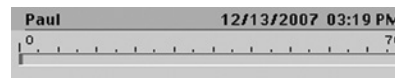

- Checkweighing graph: If **Minimum/maximum or Setpt./tolerance** is selected for the “Initial weight” parameter, the bar graph shows checkweighing values; i.e., target weight and tolerance limits (user-defined).



Measured value/result line with stability symbol

This line shows:

- the current weight value with plus or minus sign and weight unit

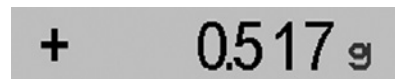

- calculated values with plus or minus sign and weight unit (e.g., humidity - moisture)



- Stability symbol

Text line

These lines show information on the drying program during analysis.



Prompt/status line

This line shows either a prompt, such as “Open the cover,” or the status of the instrument.



Touchscreen Buttons

The display shows five large buttons along the bottom of the screen. Texts or graphic symbols (such as arrows) indicate the function of these buttons at any given point. The main window, for example, may show the following buttons:

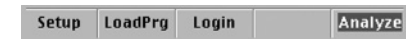

When configuring parameters in the Setup menu:



Message windows

Message windows are shown briefly and cover up a portion of the display screen. Message windows can contain information, warnings or prompts, such as

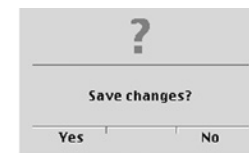

Additional message windows are described in the chapter entitled “Operating Design.”

Built-in Printer

You can activate or deactivate the built-in printer in the Setup menu, under:

Setup > Configuration > Serial port parameters > Built-in printer

Print Parameters

You can define whether data and sensor values are printed automatically and configure up to three header lines under:



Setup > Configuration > Print parameters

Print formats

In the Setup menu, you can define the formatting for printouts of analysis data and statistical evaluations.

- Header
- Intermediate results
- Footer
- Statistics

The following applies for these configuration options:

- Menu lines are not touch-sensitive
- Navigation and selection are possible only using the touchscreen buttons at the bottom of the display
- Press the  key to insert selection
- Press the  key to return to the previous menu level
- Tap the **Delete** button to delete an entry from the list

Setup > Configuration > Print formats

Printout

The next column shows a sample of a printout generated after analysis.

Printout: Sample Printout: Record of Analysis

123456789012345678901234567890123456789

Workstation 234
Sartorius
Goettingen

28.11.2007 16:41:46
Sartorius Microwave
Moisture Analyzer
LMA200PM-000EU Rel. 01.00.00
Serial no. 12345678

Prg. ketchup
Mode: Standard | Process: R Standard
Level: 30 %
End: Automatic
Initial weight: + 2.125 g

00:40 + 0.752 g + 64.63 %M
Signature

Data Interfaces

The LMA200PM has three data interfaces for input and output

- An RS-232 interface for connecting an external printer or computer
- A PS/2 interface for connecting a PC keyboard or a barcode scanner
- An Ethernet interface for connecting a computer over a network adapter

External Printer

Data records can be output over this interface with the same layout format used by the built-in printer.

PC Keyboard

You can connect a PC keyboard with a PS/2 male connector (maximum 150 mA) to the PS/2 port on the moisture analyzer. Operation through the PC keyboard is analogous to use of the analyzer's touchscreen keypad.

Barcode Scanner

Alternative to a PC keyboard, you can connect a barcode scanner for data input.

Ethernet

Using the Ethernet port and a web browser, your moisture analyzer can communicate using virtual network computing (VNC).

Use of Pre-assembled RS-232

Connecting Cable

You can use pre-assembled RS-232 connecting cable to connect an external printer.

Caution:

Do not use Sartorius cables with order number 7357312 or 7357315!

RS-232 Interface

Type of interface:	Serial interface
Operating mode:	Full duplex
Standard:	RS-232
Protocol:	XON/XOFF, RTS/CTS, 2-wire, or none
Transmission rates:	300, 600, 1,200, 2,400, 4,800, 9,600, 19,200, 38,400 baud
Number of data bits:	7 or 8*
Parity:	None, even, odd
Stop bits:	1 or 2
Signal level, input:	Logic 1 (high) -3 to -15 V Logic 0 (low) +3 to +15 V
Signal level, output:	Logic 1 (high) -5 to -15 V Logic 0 (low) +5 to +15 V
Number of signals:	2 input signals (Rx/D, CTS) 2 output signals (Tx/D, RTS)
Potential separation:	None
Cable type:	Shielded twisted pair (e.g., LifyCY 3 × 2 × 0.20) 1 conductor pair for ground
Cable length:	Maximum 15 m
Output format:	2 spaces + 40 characters + CRLF

- * 8 bits: Special characters are permitted
7 bits: Umlauts (ä, ö, ü, Ä, Ö, Ü, ß) are expanded to ae, oe, ue, Ae, Oe, Ue, ss
Other language specific conversions: A, E, I, O, U, C, N and space

Factory settings for interface parameters:

Protocol:	XON/XOFF
Baud rate:	9,600
Bits:	8
Parity:	Odd
Stop bits:	1

Pin Assignments and Connector Diagram

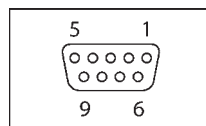

D-sub socket

- Pin 1: Not connected
- Pin 2: Data output (Tx/D)
- Pin 3: Data input (Rx/D)
- Pin 4: Not connected
- Pin 5: Signal ground (GND)
- Pin 6: Not connected
- Pin 7: Clear to send (CTS)
- Pin 8: Request to send (RTS)
- Pin 9: Not connected

Printout

The settings under “Printout” let you configure the RS-232 interface so that measured and calculated data is output to an external printer with the same formatting as that used by the built-in printer (2 spaces + 40 characters + CRLF). See:

Setup > Configuration > Device > Serial port parameters > RS-232 > Mode > Printout

PS/2 Port

You can connect a PC keyboard or a barcode scanner on the PS/2 port.

Socket:	6-pin
Power consumption:	Max. 0.75 VA
Current:	Max. 150 mA
Voltage:	Max. 5 V

Pin Assignments and Connector Diagram



- Pin 1: Data line (DATA)
- Pin 2: Not connected
- Pin 3: Ground (GND)
- Pin 4: Power supply + 5V
- Pin 5: Pulse signal (CLK)
- Pin 6: Not connected

PC Keyboard

Operation of the LMA200PM using an external PC keyboard is analogous to operation with the analyzer controls.

For example you can use the PC keyboard to enter texts, such as parameters for drying programs (long name, short name, etc.).

The touchscreen buttons have the following equivalents on the PC keyboard:



These assignments apply at all times, regardless of the labels (in the above example, the arrow keys) shown on the touchscreen buttons at any given point. The following equivalents also apply:

F5:	Back
F12:	Print
Enter:	Confirm
Arrow keys:	Like the touchscreen arrow buttons
Keyboard layout*:	German: QWERTZ French: AZERTY Italian: QWERTY Spanish: QWERTY

* select under Setup > Configuration > Device > Operating parameters > PS/2 keyboard

Barcode Scanner

You can use a barcode scanner for data input.

The barcode scanner is configured by scanning in the desired codes (refer to the barcode scanner manual for details).

You can use the following scanners with the LMA200PM:

- Opticon OPL 6735 Wedge
- Syntech Cipher 1021G
- Gryphomn M-100

Setting for Opticon OPL 6735 Wedge:

Linker:	AT wedge
Keyboard layout:	<with keyboard>*
Keyboard language:	<US>*
Intercharacter delay for wedge:	Delay = 10
Set suffix:	Clear all suffixes
Read mode options:	Single read
Redundancy**:	3 times redundant

* Factory settings (defaults) given in pointed brackets < >.

** For reliable scanning, set the barcode scanner for three redundant scanning operations.

If you want to have each scanning operation confirmed by pressing a key on the analyzer, the barcode scanner’s automatic CR function must be switched off.

Ethernet Interface

The LMA200PM is equipped with a port for connection to an Ethernet network. This enables remote operation in a browser window, over a local network or the Internet.

Configure the following settings for remote operation:

- Device name
- Use DHCP*
- IP address
- Subnet mask
- Standard gateway
- Remote access for VNC client**

*The dynamic host configuration protocol (DHCP) server automatically allocates IP addresses.

**Virtual network computing (VNC) is a software package for remote desktop display. The VNC Server software runs on the remote computer, enabling the local computer – running VNC Viewer software – to view and operate the remote desktop. This lets you use the remote computer as though you were seated directly in front of it.

If DHCP is not used, the IP address of the moisture analyzer should be as similar as possible to that of the local computer, for example:

- IP address of computer: 192.168.178.20
- IP address of LMA200PM: 192.168.178.21

The settings for subnet mask and standard gateway should be the same as those in the local computer. These settings are configured in the Windows® operating system under: Start > Control Panel > Network and Dial-up Connections > <name of the active network connection> > Support

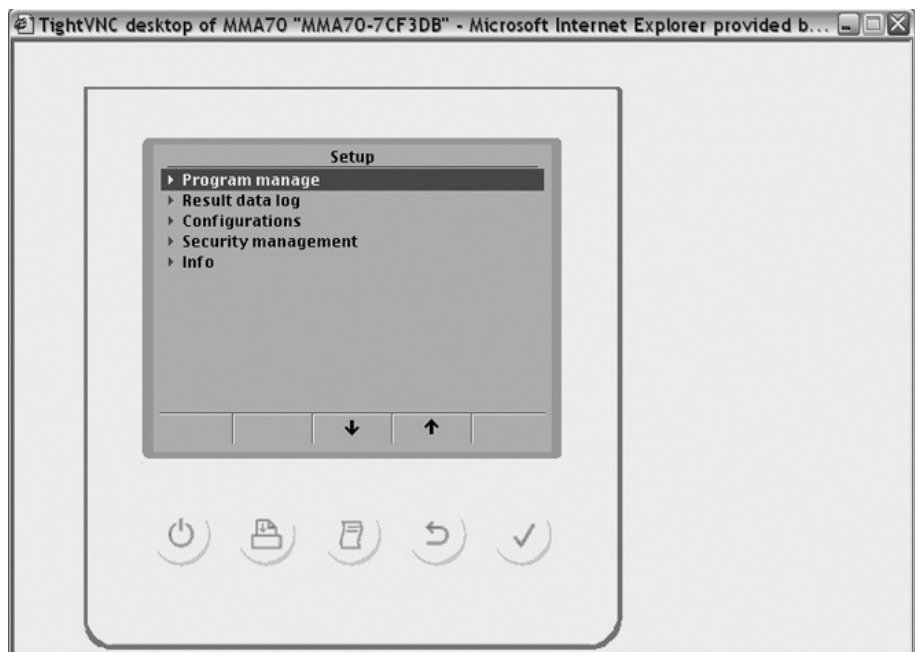
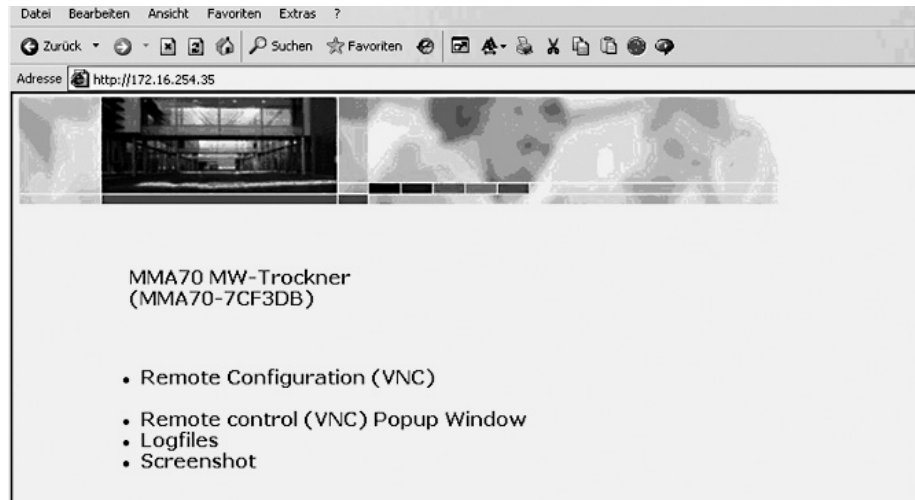

Saving Data

Storing Parameter Settings

The most recent configurations of Setup menu parameters are active when you switch on the moisture analyzer. You also have the option of restoring the factory settings (see "Security Management" in the chapter entitled "Configuration").

Saving the Settings

The function for saving data may be accessible to all or password-protected:

- Accessible: Any operator can save data without entering a PIN.
- Password-protected: A user name must be selected and the associated PIN must be entered.

The user account (user name and PIN) is set up by the administrator and assigned to one of three groups:

- Administrator
- Supervisor
- Operator

See the chapter entitled "Configuration" for details on user privileges.

Troubleshooting Guide

Error messages are shown in the text line or measured value line of the display.

Display	Cause	Solution
No segments shown	No AC power is available AC adapter not plugged in	Check the AC power supply Connect AC adapter to the wall outlet (mains)
	Fuses are defective The analyzer is switched off	Replace the fuses Press the power switch (on/off) on the back panel
L / ERR 54	Load is below the weighing range	Place a load on the weighing module
	Sample retainer not in place	Place the sample retainer on the weighing module
H	The load exceeds the weighing module capacity	Unload the weighing module
ERR 02	Calibration/adjustment condition not met, e.g., – not tared – the sample retainer is loaded	Calibrate only when zero is displayed Tare the weighing module Unload the sample retainer
ERR 03	Calibration/adjustment could not be completed within the required time period	Allow the scale to warm up again and repeat the adjustment
expected xxx	Wrong format	Enter data correctly
Wrong format		
bad xxx/illegal xxx Not permitted	Outside the range	Enter data correctly
must not be more than xxx Too high	Outside the range	Enter data correctly
must not be less than xxx Too low	Outside the range	Enter data correctly
Value exceeds display	Value has more characters than the display can show	Change configuration. See the chapter entitled “Configuration,” under “Configuring Parameters in the Setup Menu”
ERR Config. data	Checksum errors; may indicate change in versions (e.g., after software update) or dead battery	Switch the moisture analyzer off and on again
ERR Adjust. data		
ERR Printout config.		
ERR DB user		
ERR DB programs		
ERR DB results		

Messages

Messages are shown on the display at the time the event triggering the message occurs (covers other displayed data). For details on messages, see the chapter entitled “Operating Design.”

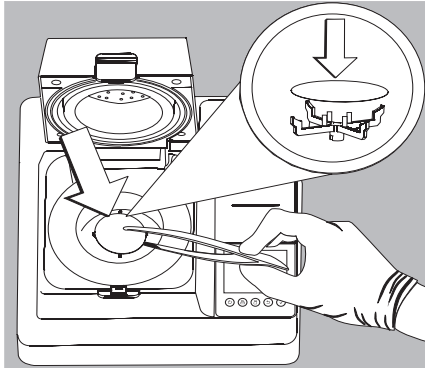

Inserting a Glass Fiber Pad

- Open the cover
- Use the forceps to place the glass fiber pad on the sample retainer.
- Make sure the pad is level.

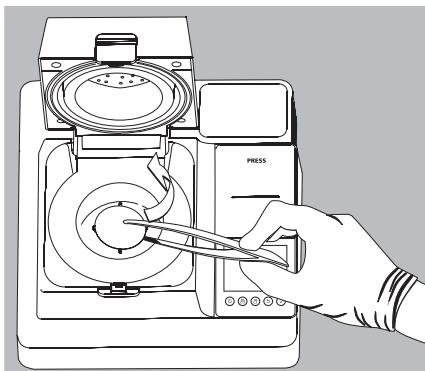

Removing a Glass Fiber Pad

Note:

Immediately following analysis, the sample chamber and the sample are still hot. To avoid injury, observe the warnings and safety precautions included in these instructions.

When analyzing samples that can be deemed hazardous, protective goggles, clothing and gloves must be worn when opening the analyzer cover after analysis.

- Open the cover.
- Use the forceps to grasp the glass fiber pad and carefully remove it from the sample chamber.

Replacing the Printer Paper

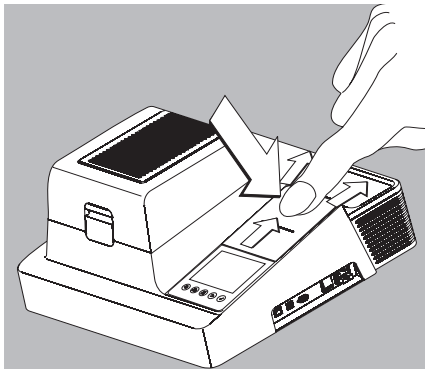

- Press down briefly on the cover of the printer compartment and release.
- Slide the cover towards the back of the analyzer.

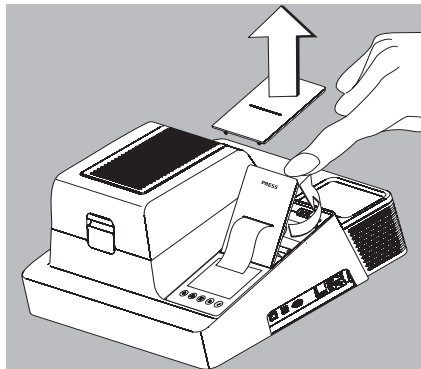

- Raise the cover and remove it.

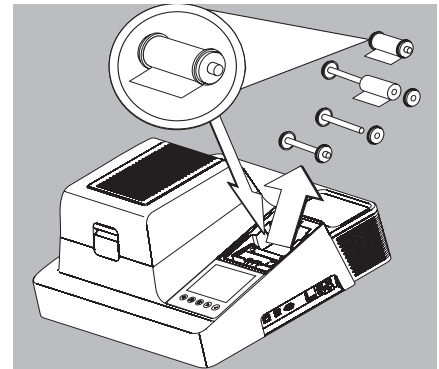

- Place the new paper roll on the spindle as illustrated above and place it in the printer compartment.



- Release the locking mechanism.
- Guide the printer paper under the roller.
- Reset the locking mechanism.

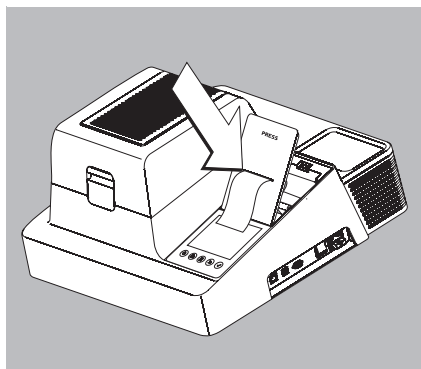

- Guide the end of the paper roll through the slot on the compartment cover.
- Position the cover.

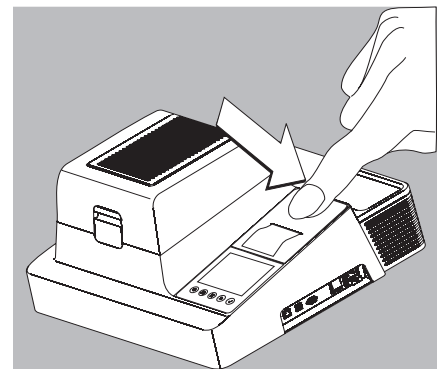

- Press down on the cover of the printer compartment.
- The printer compartment closes.

Care and Maintenance

Service

Regular servicing will ensure the continued accuracy of your moisture analyzer. The optimum length of the interval between service visits depends on the operating conditions at the place of installation and on your requirements.

Repairs

- ⚠ A defective moisture analyzer must be disconnected from the power supply immediately (unplug the cord from the wall socket). Repair work must be performed by authorized Sartorius service technicians using original Sartorius spare parts. Any attempt by untrained persons to perform repairs may result in considerable hazards for the user.
- ⚠ If a cable is damaged or defective, replace the cable as a complete unit with all its connectors.
- ⚠ Do not open the LMA200PM moisture analyzer while it is carrying current. Allow approximately 10 seconds to elapse after disconnecting the equipment from power before opening the equipment housing. Because the integrity of the fitting surfaces is essential for safe operation of the LMA200PM, always exercise caution when opening and closing the equipment housing.
- ⚠ When replacing the battery on the PCB, the same or an equivalent type of battery (approved by the manufacturer) must be installed. To prevent hazard of explosion, make absolutely sure the polarity is correct.

Cleaning

- ⚠ Disconnect the LMA200PM moisture analyzer from power (unplug the cord from the wall outlet (mains)) and disconnect any data cables.
- ⚠ Do not permit liquids to penetrate the housing of the moisture analyzer. Install the protective plug/transport locking device before cleaning the moisture analyzer.
- ⚠ Do not use any aggressive cleaning agents (solvents or similar agents).
- ⚠ Do not wash down the equipment with water or dry it with compressed air.
- Clean the moisture analyzer using a piece of cloth that has been dampened with a mild detergent (soap).
- If used in the food industry, make sure the cleaning agent is suitable for use in the particular working environment.
- Dry the moisture analyzer with a soft cloth.

Cleaning the Sample Chamber

- Open the cover.
- Remove the adapter and the sample retainer.
- Insert the protective plug before cleaning. Make sure that no liquid remaining on the sample retainer penetrates the weighing system.

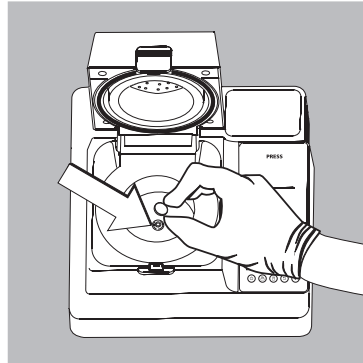

- Use a lint-free, anti-static laboratory wipe or cleaning cloth to carefully clean the sample chamber, including the inside of the cover. Make sure the sealing surface between the sample chamber and the cover is clean and free of damage. If a detergent is necessary, use a gentle cleaning agent.
- After cleaning, wipe the entire the sample chamber dry, including the inside of the cover.
- ⚠ Use of a sharp-edged object to clean surfaces in the sample chamber or, in particular, the sealing surfaces between the upper and lower parts of the sample chamber is not permitted, as this will damage the PTFE coating. If any part of the sealing surfaces between the upper and lower parts of the sample chamber is damaged or contaminated, operation of the moisture analyzer will place the operator at risk of physical injury. Make sure no liquid penetrates the safety lock on the analyzer cover.
- If necessary, remove the adapter from the sample retainer carefully and clean it. When cleaning the sample retainer, make sure that no liquid remains on the sample retainer that could penetrate the analyzer housing. After cleaning, wipe the sample retainer dry and then carefully replace it on the analytical weighing system and turn it slightly until it clicks into place.

Safety Inspection

- Each of the following conditions indicates that safe operation of the moisture analyzer is no longer ensured:
- Visible damage to the device or power cord
 - Defective built-in power supply, cooling fan or safety switch on the analyzer cover
 - Blockage of the analyzer cover or any of the cooling fans
 - Damage or defects to the PTFE coating of the sample chamber or the sealing surfaces between the cover and sample chamber
 - Storage of the moisture analyzer for a relatively long period under unfavorable conditions (e.g., extreme moisture)

If there is any indication that safe operation of the moisture analyzer is no longer warranted, disconnect the moisture analyzer from power (unplug the equipment from the wall outlet (mains)) and lock it in a safe place to ensure that it cannot be used.

Maintenance and repair work may be performed only by authorized Sartorius service technicians who have access to the required service and maintenance manuals and have attended the relevant service training courses.

- ⚠ The seals affixed to this moisture analyzer indicate that only authorized Sartorius service technicians are allowed to open the equipment and perform maintenance work so that safe and trouble-free operation of the equipment is ensured and the warranty remains in effect.

Recycling

Packaging that is no longer required must be disposed of at the local waste disposal facility. The packaging is made of environmentally friendly materials that can be used as secondary raw materials.



The moisture analyzer, accessories and batteries, including batteries on the PCB, may not be disposed of with regular household waste. Please contact your municipal waste disposal authority or waste management company. Prior to disposal and/or scrapping of the equipment, any batteries should be removed and disposed of in local collection boxes. Sartorius, its affiliates, subsidiaries, dealers and distributors will not take back equipment contaminated with hazardous materials (ABC contamination) – either for repair or disposal.

Specifications

Specifications

Measurement method	Sample heated by microwave radiation; moisture content calculated from loss on drying
Microwave generator	1000 W
Power output	2% to 100%, configurable in 1%-steps
Measurement range	8% to 100%
Accuracy	From 1 g initial sample weight +/- 0.05%
Response time	Approximately 40 to 120 seconds (depends on sample and moisture content)
Display of results	% moisture content with calculation options; ppm moisture content, % volatile components, %, ppm solids, g solids, mg solids, % ratio
Weighing capacity	70 g
Resolution reading accuracy of the weighing system	0.1 mg
Reading accuracy of the measurement results	0.001%
Display module	¼ VGA
Control elements	Touchscreen, 5 function keys
Program memory	320 drying programs with alphanumeric designation
Data storage	The 500 most recent results, with statistical evaluation, stored in battery-backed memory
Built-in printer	Thermal printer, 40 characters per line
Data interfaces	1 serial RS-232 interface, 1 Ethernet port
Power source	230 V, 50 Hz, 1200 VA (LMA200PM-000EU) 115 V, 60 Hz, 1200 VA (LMA200PM-000US)
Fuse	2 × 10 A/T (5 × 20 mm)
Ambient conditions	Indoor use only
Altitude	up to 2000 m
Operating temperature range	5°C to 40°C (41°F to 104°F)
Allowable storage temperature range	-10°C to +60°C (14°F to 140°F)
Humidity	Maximum relative humidity: 80% for temperatures up to 31°C, linear decrease to 50% relative humidity at +40°C
Dimensions (H × W × D)	304 × 510 × 535 mm (12 × 20 × 21 in.)
Weight	Approximately 22 kg (48.4 lbs)
Pollution degree 2	Normally only nonconductive pollution or temporary conductivity caused by condensation.
Limitation of emissions	In accordance with EN 61326-1 (IEC 61326-1): Group 1, Class B, suitable for use in domestic establishments and establishments directly connected to a low-voltage power-supply network that supplies buildings used for domestic purposes.
Immunity to interference	In accordance with EN 61326-1, (IEC-1): Immunity test requirements for equipment intended for use in industrial locations (Table 2)
Electrical safety	In accordance with EN 61010-1 (IEC 61010-1)

Accessories/Options

Product	Order No.
80 glass fiber pads	6906940
500 disposable pipettes	YATO1MA
Printer paper (five 20-m rolls)	69MA30100

Dimensions (Scale Drawings)

All dimensions given in mm

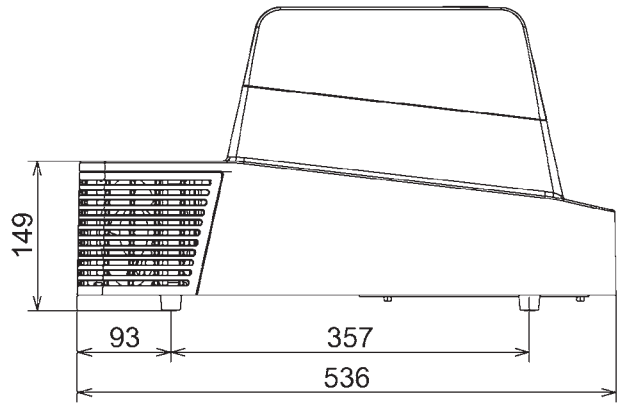
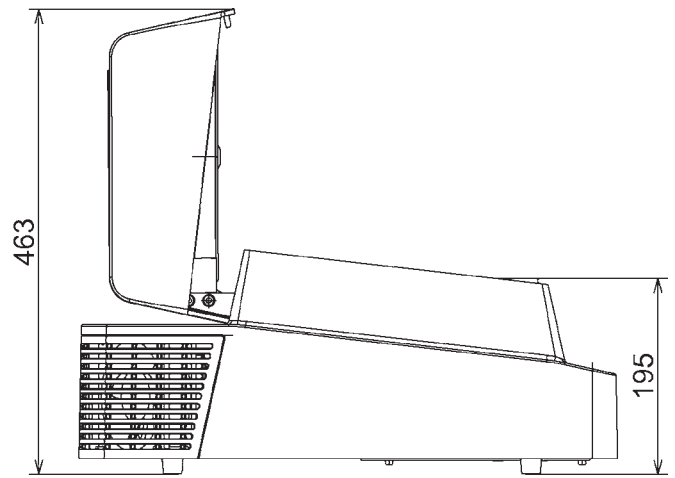
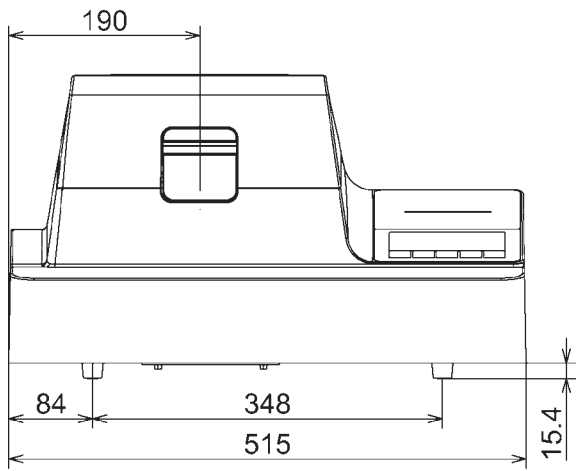

CE EU-Konformitätserklärung EU Declaration of Conformity

Hersteller
Manufacturer Sartorius Lab Instruments GmbH & Co. KG
37070 Goettingen, Germany

erklärt in alleiniger Verantwortung, dass das Betriebsmittel
declares under sole responsibility that the equipment

Geräteart
Device type Feuchtebestimmer
Moisture Analyzer

Baureihe
Type series MA35M-000aVb, MA100C-000aV1, MA100H-000aV1, MA100Q-000aV1
MA150C-000aV1, MA150Q-000aV1, LMA200PM-000US, LMA200PM-000EU
a= 115 oder/oder 230; b = 1, 2 oder/oder 3

in der von uns in Verkehr gebrachten Ausführung allen einschlägigen Bestimmungen der folgenden Europäischen Richtlinien – einschließlich deren zum Zeitpunkt der Erklärung geltenden Änderungen – entspricht und die anwendbaren Anforderungen folgender harmonisierter Europäischer Normen erfüllt:
in the form as delivered fulfils all the relevant provisions of the following European Directives – including any amendments valid at the time this declaration was signed – and meets the applicable requirements of the harmonized European Standards listed below:

2014/30/EU Elektromagnetische Verträglichkeit
Electromagnetic compatibility
EN 61326-1:2013

2014/35/EU Elektrische Betriebsmittel zur Verwendung innerhalb bestimmter Spannungsgrenzen
Electrical equipment designed for use within certain voltage limits
EN 61010-1:2010

2011/65/EU Beschränkung der Verwendung bestimmter gefährlicher Stoffe in Elektro- und Elektronikgeräten (RoHS)
Restriction of the use of certain hazardous substances in electrical and electronic equipment (RoHS)
EN 50581:2012

Jahreszahl der CE-Kennzeichenvergabe | *Year of the CE mark assignment:* 16

Sartorius Lab Instruments GmbH & Co. KG
Goettingen, 2016-04-20

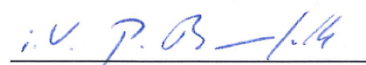

Dr. Reinhard Baumfalk
Vice President R&D



Dr. Dieter Klausgrete
Head of International Certification Management

Diese Erklärung bescheinigt die Übereinstimmung mit den genannten EU-Richtlinien, ist jedoch keine Zusicherung von Eigenschaften. Bei einer mit uns nicht abgestimmten Änderung des Produktes verliert diese Erklärung ihre Gültigkeit. Die Sicherheitshinweise der zugehörigen Produktdokumentation sind zu beachten.

This declaration certifies conformity with the above mentioned EU Directives, but does not guarantee product attributes. Unauthorised product modifications make this declaration invalid. The safety information in the associated product documentation must be observed.

Sartorius Lab Instruments GmbH & Co. KG
Otto-Brenner-Strasse 20
37079 Goettingen, Germany

Phone: +49.551.308.0
Fax: +49.551.308.3289
www.sartorius.com

The information and figures contained in these instructions correspond to the version date specified below.

Sartorius reserves the right to make changes to the technology, features, specifications and design of the equipment without notice.

Masculine or feminine forms are used to facilitate legibility in these instructions and always simultaneously denote the other gender as well.

Copyright notice:

This instruction manual, including all of its components, is protected by copyright.

Any use beyond the limits of the copyright law is not permitted without our approval.

This applies in particular to reprinting, translation and editing irrespective of the type of media used.

© Sartorius Germany

Last updated:
04 | 2016