

# Precision and Analytical Balances

ME-T

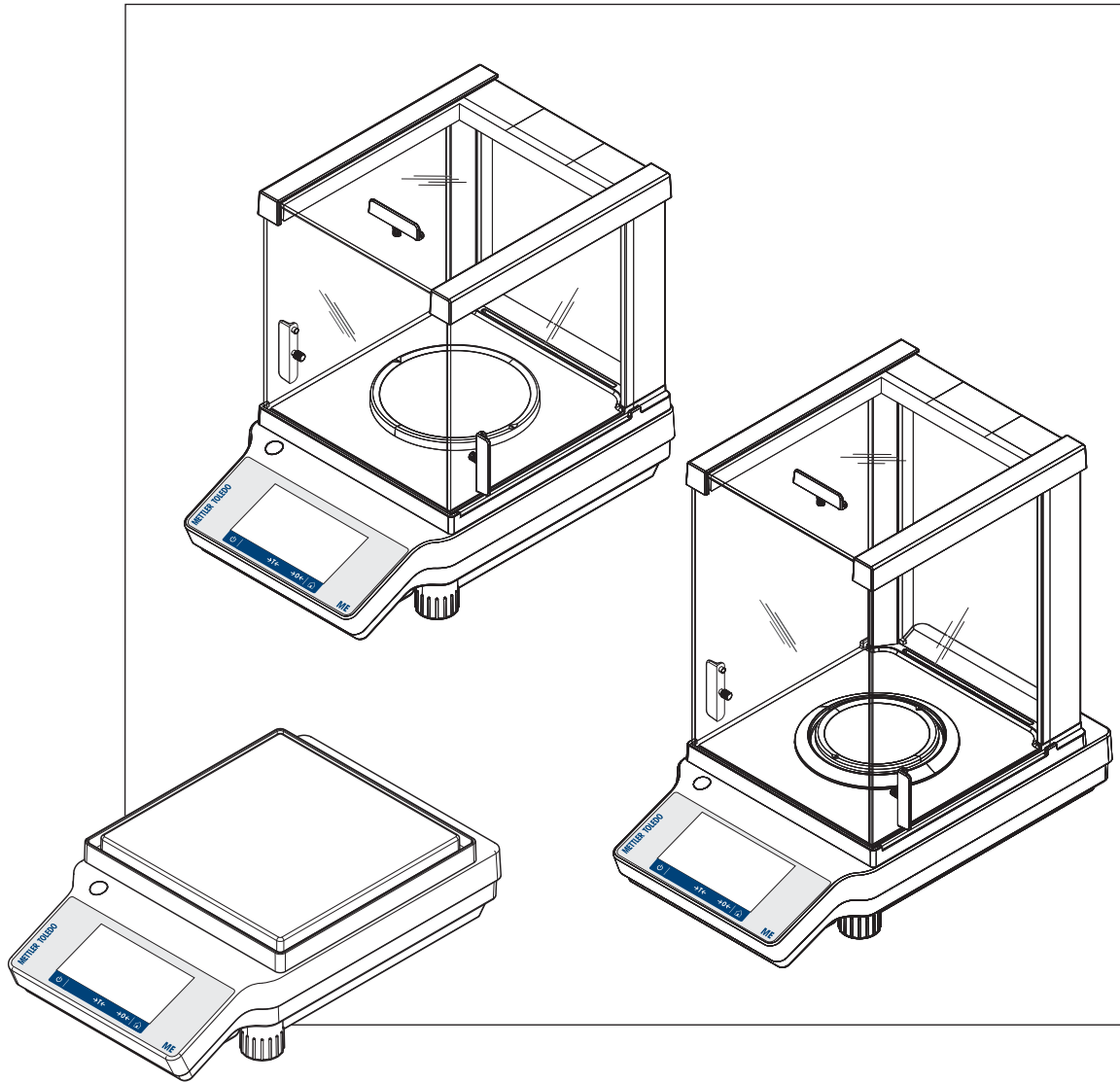

**METTLER TOLEDO**



# Table of Contents

<b>1</b>	<b>Introduction</b>	<b>5</b>
1.1	Conventions and symbols used in these operating instructions	5
<b>2</b>	<b>Safety Information</b>	<b>6</b>
2.1	Definition of signal warnings and symbols	6
2.2	Product safety information	6
<b>3</b>	<b>Design and Function</b>	<b>8</b>
3.1	Overview	8
3.2	Peripheral devices	9
3.3	Operation keys	10
3.4	User Interface	11
3.4.1	Application home screen	12
3.4.2	Input Dialogs	13
3.4.2.1	Entering Characters and Numbers	13
3.4.2.2	Changing the date and time	14
3.4.3	Lists and tables	15
3.4.4	Detailed balance information	16
<b>4</b>	<b>Installation and Putting into Operation</b>	<b>17</b>
4.1	Scope of delivery	17
4.2	Installing the components	18
4.3	Installing Protective Cover	20
4.4	Selecting the location	21
4.5	Connecting the instrument	21
4.6	Leveling the balance	22
4.7	Switching on the balance	22
4.8	Switching off the balance	22
4.9	Zeroing	22
4.10	Taring	23
4.11	Transporting the balance	24
4.12	Weighing Below the Balance	24
4.13	General requirements	25
4.13.1	Warming up the balance	25
4.13.2	Adjusting the balance	25
<b>5</b>	<b>Weighing Made Simple</b>	<b>26</b>
5.1	Main settings and activities at a glance	26
5.2	Navigation on the touch screen	27
5.2.1	Opening an application	27
5.2.2	Scrolling	27
5.2.3	Using shortcuts	28
5.3	Performing a simple weighing	28
5.4	Switching the weighing unit	30
5.5	Changing the resolution	32
5.6	Application settings	33
5.6.1	Main configuration	33
5.6.2	Reports configuration	33
5.6.2.1	Working with IDs	34
5.6.2.2	Defining an ID	35
5.6.2.3	Workflow handling options	36
5.6.3	Statistics	37
<b>6</b>	<b>Activities</b>	<b>38</b>
6.1	Activities - Weighing applications	38
6.1.1	Weighing	39

6.1.2	Counting	40
6.1.2.1	Defining reference piece weight in Standard mode	40
6.1.2.2	Defining reference piece weight in Advanced mode	41
6.1.2.3	Counting - Main configuration	43
6.1.3	Percent Weighing	44
6.1.4	Formulation	46
6.1.5	Dynamic Weighing	48
6.1.6	Density	50
6.1.7	Check Weighing	52
6.1.8	Factor Weighing	56
6.1.9	Totaling	57
6.2	Activities - Adjustments and tests	59
6.2.1	FACT Fully automatic internal adjustment (for ME-T models only)	60
6.2.2	Internal Adjustment	61
6.2.3	External Adjustment	62
6.2.4	Fine adjustment	63
6.2.5	Routine test	64
6.2.6	Repeatability test	65
<b>7 General Settings</b>		<b>66</b>
7.1	Quick settings	66
7.1.1	Date and time	66
7.1.2	Brightness	66
7.1.3	Sound	67
7.1.4	Language	67
7.1.5	Glove mode	67
7.1.6	Quick Adjustment	67
7.1.7	Date/Time widget	67
7.2	General configuration	68
7.2.1	Weighing options	68
7.2.2	Publishing	69
7.2.3	Devices and connectivity	71
7.2.4	System settings	72
7.2.5	Access protection	73
7.2.6	ISO-log	73
<b>8 Communication with Peripheral Devices</b>		<b>74</b>
8.1	PC-Direct Function	74
8.2	USB Device Interface	75
<b>9 Error and Status Messages</b>		<b>77</b>
<b>10 Maintenance</b>		<b>78</b>
10.1	Cleaning and Service	78
10.2	Draft Shield	78
10.3	Disposal	79
<b>11 Interface Specification</b>		<b>80</b>
11.1	RS232 interface	80
11.2	USB host	81
11.3	USB device	81
11.4	MT-SICS interface commands and functions	82
<b>12 Technical Data</b>		<b>83</b>
12.1	General Data	83
12.2	Model-Specific Data	84
12.2.1	Balances with readability of 0.1 mg with draft shield	84
12.2.2	Balances with readability of 1 mg with draft shield	87
12.2.3	Balances with readability of 10 mg / 0.1 g	92

12.3	Dimensions	98
12.3.1	Balances with readability of 0.1 mg with draft shield high	98
12.3.2	Balances with readability of 1 mg with draft shield low	99
12.3.3	Balances with readability of 10 mg / 0.1 g	100
<b>13 Accessories and Spare Parts</b>		<b>101</b>
<b>14 Appendix</b>		<b>108</b>
14.1	Weighing Units	108
<b>Index</b>		<b>109</b>



# 1 Introduction

Thank you for choosing a METTLER TOLEDO balance. The precision and analytical balances of the ME-T line combine a large number of weighing possibilities with easy operation.

These operating instructions apply to all balance models of the ME-T line and are based on the initially installed firmware (software) version V 3.40.

## Finding more information

► [www.mt.com/balances](http://www.mt.com/balances)

More detailed information can be found in the Operating Instructions on the CD-ROM.

## 1.1 Conventions and symbols used in these operating instructions

Key and button designations are indicated by a picture or text in square brackets (e.g. [  ]).

These symbols indicate an instruction:

- prerequisites
- 1 steps
- 2 ...
- ⇒ results

## 2 Safety Information

### 2.1 Definition of signal warnings and symbols

Safety notes are marked with signal words and warning symbols. These show safety issues and warnings. Ignoring the safety notes may lead to personal injury, damage to the instrument, malfunctions and false results.

<b>WARNING</b>	for a hazardous situation with medium risk, possibly resulting in severe injuries or death if not avoided.
<b>CAUTION</b>	for a hazardous situation with low risk, resulting in damage to the device or the property or in loss of data, or minor or medium injuries if not avoided.
<b>Attention</b>	(no symbol) for important information about the product.
<b>Note</b>	(no symbol) for useful information about the product.



General hazard



Electrical shock

### 2.2 Product safety information

#### Intended use

Your balance is used for weighing. Use the balance exclusively for this purpose. Any other type of use and operation beyond the limits of technical specifications without written consent from Mettler-Toledo GmbH, is considered as not intended.



It is not permitted to use the instrument in explosive atmosphere of gases, steam, fog, dust and flammable dust (hazardous environments).

#### General safety information

This balance complies with current industry standards and the recognized safety regulations; however, it can constitute a hazard in use. Do not open the balance housing: The balance contains no user-serviceable parts. In the event of problems, please contact a METTLER TOLEDO representative.

Always operate and use your instrument only in accordance with the instructions contained in this manual. The instructions for setting up your new instrument must be strictly observed.

**If the instrument is not used according to these Operating Instructions, protection of the instrument may be impaired and METTLER TOLEDO assumes no liability.**

#### Staff safety

These operating instructions must be read and understood before using the balance. These operating instructions must be retained for future reference.

The balance must not be altered or modified in any way. Only use METTLER TOLEDO original spare parts and accessories.



## Safety notes



### **CAUTION**

#### **Damage to the balance**

- 1 Only use indoors in dry locations.
- 2 Do not use pointed objects to operate the touch screen!  
The balance is of a very sturdy design, but is still a precision instrument. It must be handled with care.
- 3 Do not open the balance:  
The balance contains no user-serviceable parts. In the event of problems, please contact a METTLER TOLEDO representative.
- 4 Only use METTLER TOLEDO original accessories and peripheral devices for the balance.  
These are specifically designed for the balance.



### **WARNING**

#### **Risk of electric shock**

Use only the original universal AC/DC adapter delivered with your balance, and check that the voltage printed on it is the same as your local power supply voltage. Only plug the adapter into a socket which is grounded.

## 3 Design and Function

### 3.1 Overview

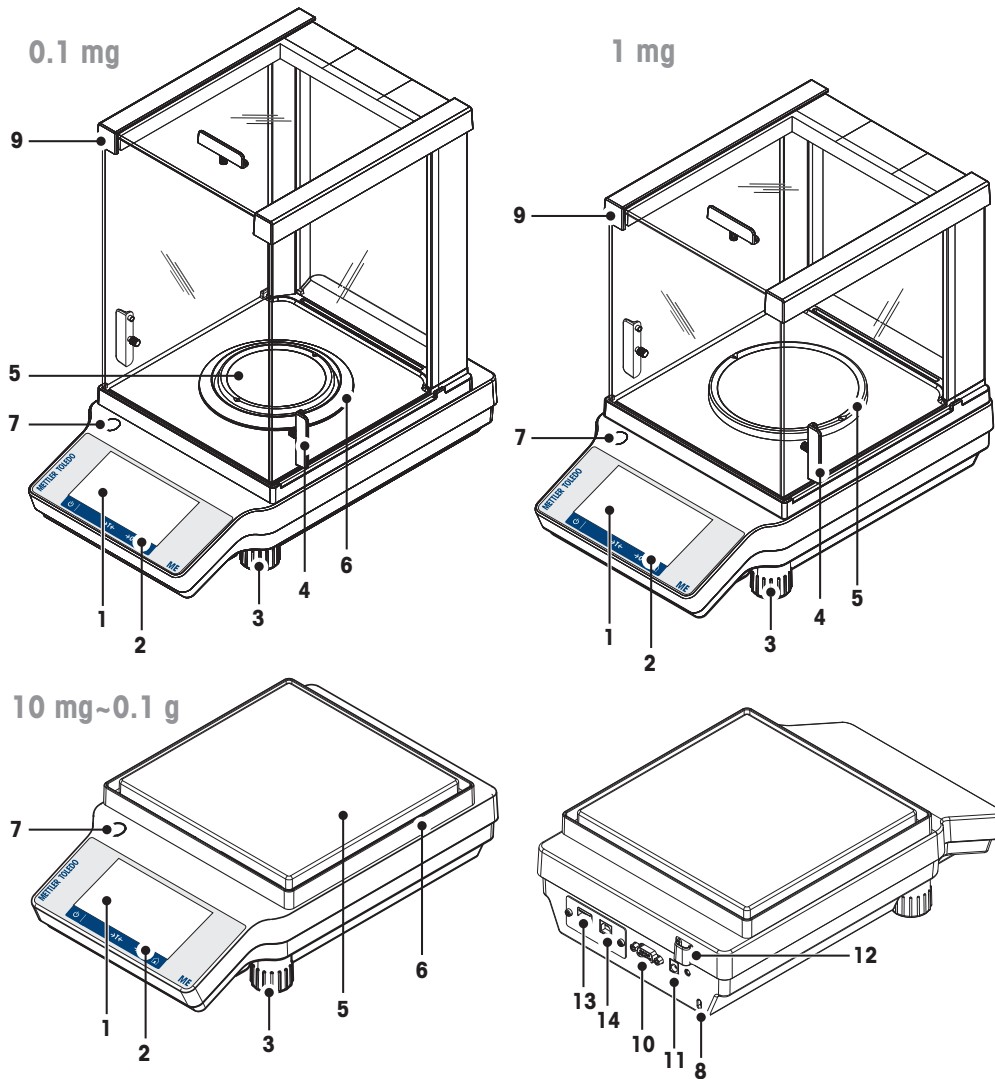

<b>1</b>	Display	<b>2</b>	Operation keys
<b>3</b>	Leveling foot	<b>4</b>	Handle for operation of the draft shield door
<b>5</b>	Weighing pan	<b>6</b>	Draft shield element
<b>7</b>	Level indicator	<b>8</b>	Kensington slot for anti-theft purposes
<b>9</b>	Glass draft shield	<b>10</b>	RS232 serial interface
<b>11</b>	Socket for AC adapter	<b>12</b>	Legal for trade (LFT) sealing
<b>13</b>	USB device	<b>14</b>	USB host

## 3.2 Peripheral devices

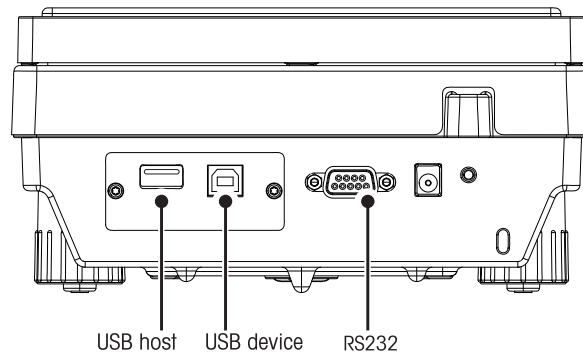





Interfaces and possible connectivity of peripheral devices:

USB Device	RS232	USB Host
PC	RS-P2x / P5x printer	Barcode reader
	Barcode reader	USB-P25 printer
	RS 2 <sup>nd</sup> display	P-5xRUE printer
	PC	USB device

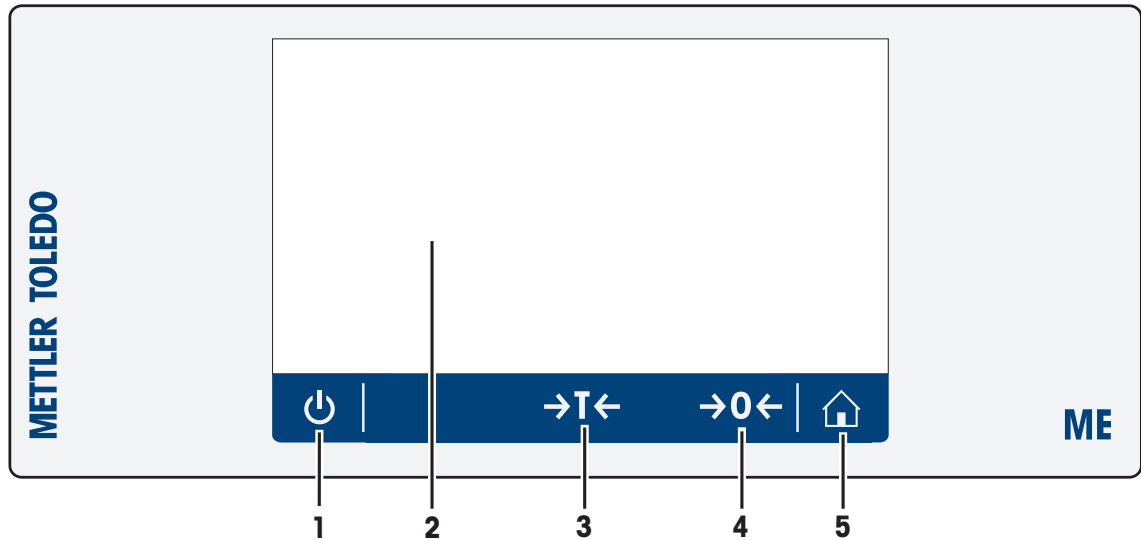
For more information about the peripheral devices see at section Accessories.

### 3.3 Operation keys



No.	Key	Name	Explanation
1		ON/OFF	To switch the instrument on or off.
2		Capacitive color TFT touch screen	General navigation
3		Tare	To tare the balance.
4		Zero	To zero the balance.
5		Home	To return from any menu level, or other window to the application home screen.

### 3.4 User Interface

The screen is a capacitive color TFT touch screen. The screen not only displays information, it also allows the user to enter commands by tapping on certain areas on its surface. You can choose the information displayed on the screen, change balance settings or perform certain operations on the instrument. Only those elements which are available for the current dialog appear on the display.



#### **CAUTION**

**Do not touch the touch screen with pointed or sharp objects!**

This may damage the touch screen.

### 3.4.1 Application home screen

The application home screen appears after the startup of the instrument. It always shows the last application that was being used before the balance was switched off. The application home screen is the main screen of the balance, from where every function can be accessed. You can always return to the application home screen by pressing on the home button [🏠] in the lower right corner of the screen.

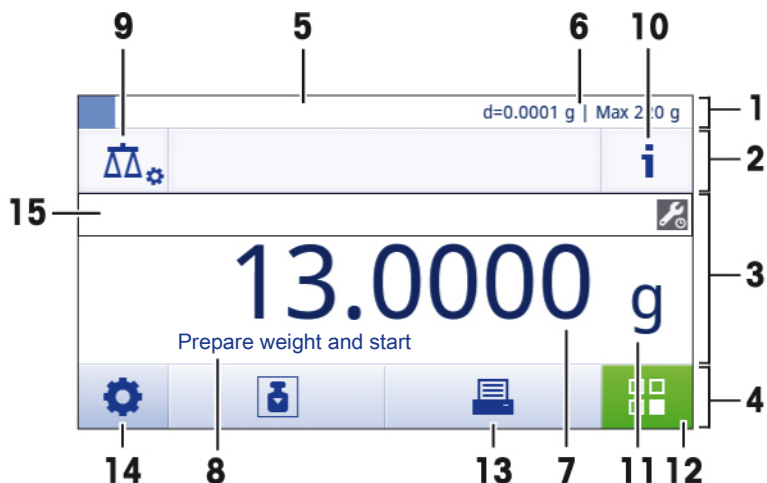

#### Information and work bars

	Name	Explanation
1	Weighing information bar	Shows the weighing-in aid and general balance information.
2	Work title bar	Shows information about the current activity.
3	Value bar	Shows information about the current weighing process.
4	Main navigation	Work-related functions.

#### Information fields

	Name	Explanation
5	Weighing-in aid	A dynamic graphic indicator shows the used amount of the total weighing range.
6	Short balance information	Readability and capacity of the balance.*
7	Weighing value field	Shows the value of the current weighing process.
8	Coach text field	Shows instructions for the current weighing process.

\* For approved balances: **Min** (minimum capacity) and **e** (Verification scale interval) are shown in the left upper corner.

#### Action buttons

	Name	Explanation
9	Main activity configuration	To configure the current application (e.g. <b>Weighing</b> ).
10	Detailed balance Information	Shows detailed technical data about the balance.
11	Weighing unit	Shows the unit of the current weighing process.
12	Activities	To open the activities selection.
13	Print	To print out results and/or settings (printer required).
14	Settings/Preferences	To configure settings/preferences.
15	Status information field	Shows information about the system status.

## 3.4.2 Input Dialogs

### 3.4.2.1 Entering Characters and Numbers

The keyboard dialog allows the user to enter characters including letters, numbers and a variety of special characters.

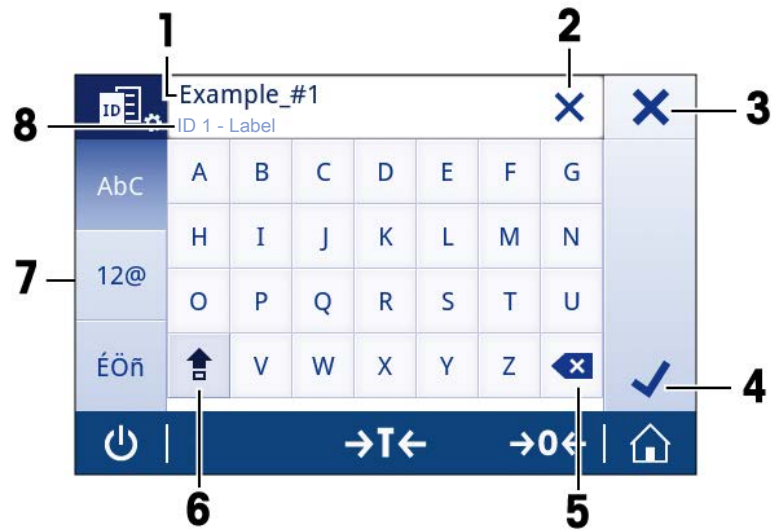

	Name	Explanation
1	Input field	Shows the characters that have been entered.
2	Delete all	To delete all entered characters.
3	Discard	To discard the entered data and to exit the dialog.
4	Confirm	To confirm the data entered.
5	Delete	To delete the last entered character.
6	Shift	To switch between lower and upper case letters.
7	Specialized tabs	To switch the keyboard mode for entering letters, numbers or special characters.
8	Explanation field	Extra information about the value to enter (e.g. the maximum number of characters available).

### 3.4.2.2 Changing the date and time

The dialog (Picker view) allows the user to set the date and time.

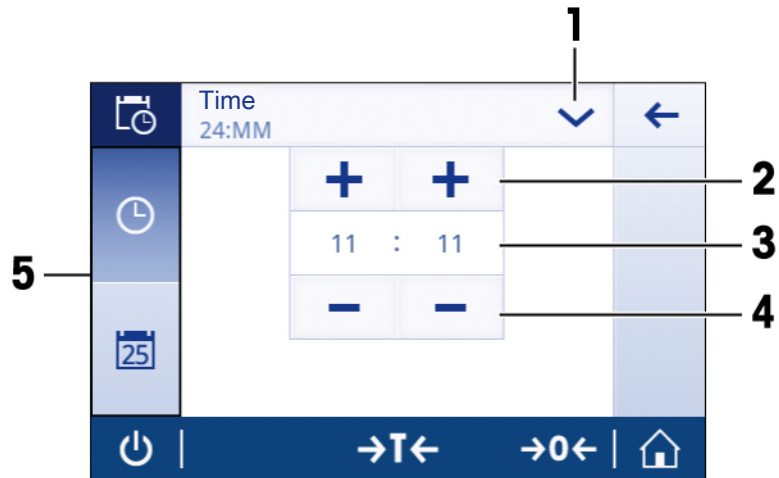

	Name	Explanation
1	Change date/time format	Various date/time formats can be chosen.
2	Pick button	Increment
3	Picker field	Shows the defined time/date.
4	Pick button	Decrement
5	Selection tabs	Tabs of the selectable sub-categories



### 3.4.3 Lists and tables

Basic elements of a simple list include a content title and a list of sub-elements. Tapping on an element opens a list of sub-elements or an input dialog.

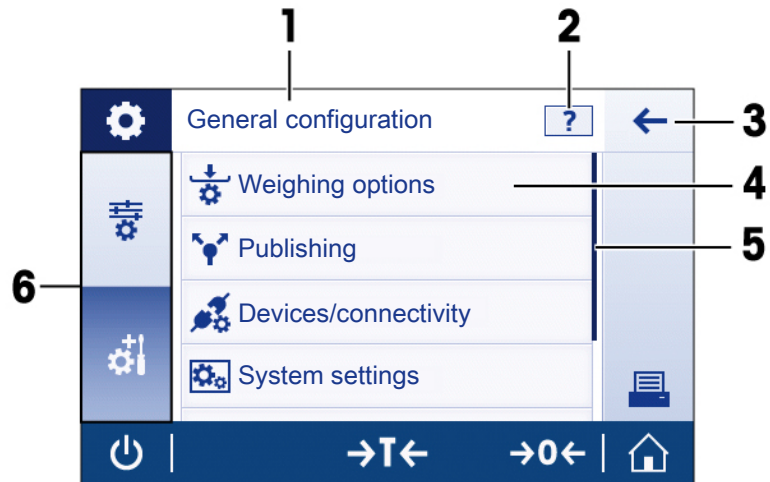

	Name	Explanation
1	List title	Title of the current list
2	Contextual help	Additional information about the current process
3	Back button	To go one step back.
4	List element title	Title of the list element
5	Scroll position	The list can be scrolled.
6	Selection tabs	Tabs of the selectable sub-categories.

### 3.4.4 Detailed balance information

- Tab on [i] to open the general balance information menu.

#### Balance information

Tap on [📄] to display **balance information**.

The display shows **balance identification** defined by the user (see the section **system settings**), information about the software and the hardware.

#### Balance support information

Tap on [✉] to display **balance support information**.

The display shows **Support information**, **Service information (next service due)** and **Quick support request**

#### Quick support request

**Quick support request** contains an unique QR code. If you have a QR (Quick Response) code reader on your smart phone, you can take a picture of the QR code. The smartphone creates an email with all relevant service information.



#### Note

Make sure that the QR code can be identified by the smart phone. A program to read the QR codes must be installed. Make sure that there are no access restrictions, which could block your email program in some way.

## 4 Installation and Putting into Operation

This section describes how to put the new instrument into operation.

### 4.1 Scope of delivery

Components		Model		
		0.1 mg	1 mg	0.1 g / 10 mg
Draft shield	high, 235 mm	✓	–	–
	low, 170 mm	–	✓	–
Weighing pan with pan support	Ø 90 mm	✓	–	–
	Ø 120 mm	–	✓	–
	180 x 180 mm	–	–	✓
Draft shield element		✓	–	✓
Pan support		–	–	✓
Protective cover		✓	✓	✓
Universal AC/DC adapter		–	✓	✓
AC/DC adapter with country-specific power cable		✓	–	–
Declaration of conformity		✓	✓	✓
User Manual		✓	✓	✓
Operating instructions: printed or on CD-ROM depending on the country.		✓	✓	✓

## 4.2 Installing the components

### Balances with readability of 0.1 mg

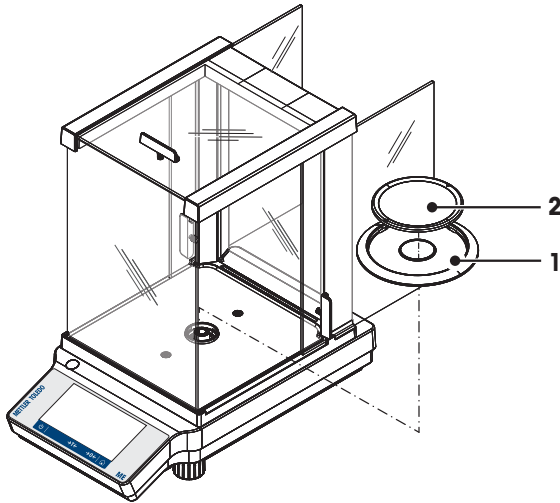

Place the following components on the balance in the specified order:

- 1 Push the side glass doors back as far as will go.
- 2 Place draft shield element (1).
- 3 Place weighing pan (2).

**2 Note**

Cleaning the draft shield **see** Cleaning and Service.

### Balances with readability of 1 mg

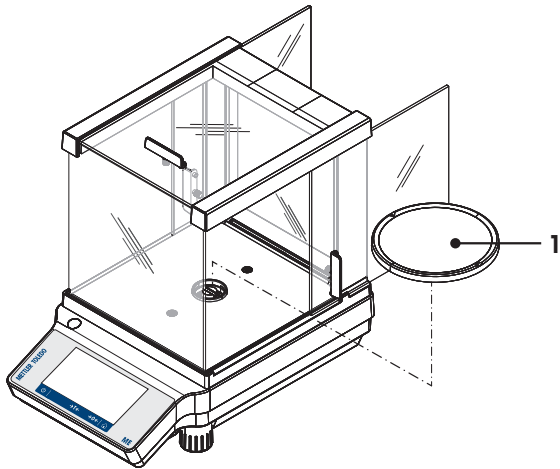

Place the following components on the balance in the specified order:

- 1 Push the side glass doors back as far as will go.
- 2 Place weighing pan (1).

**Note**

Cleaning the draft shield **see** Cleaning and Service.

### Balances with readability of 10 mg / 0.1 g

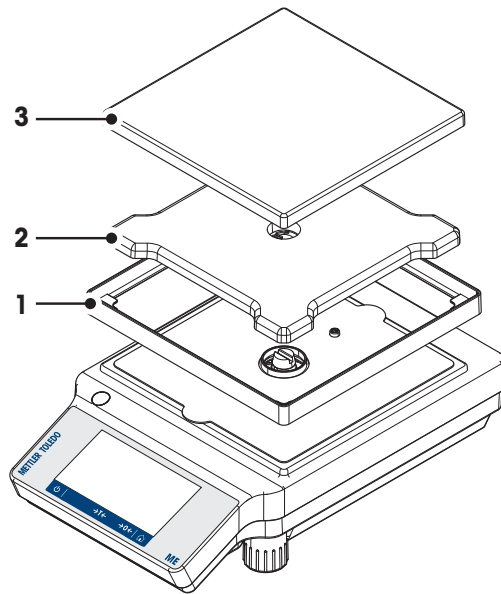

Place the following components on the balance in the specified order:

- 1 Place draft shield element (1): carefully pull apart the draft shield element to fix it under the retaining plate.
- 2 Insert pan support (2).
- 3 Place weighing pan (3).

### 4.3 Installing Protective Cover

**Note**

Make sure using the correct protective cover, **see** Accessories and Spare Parts

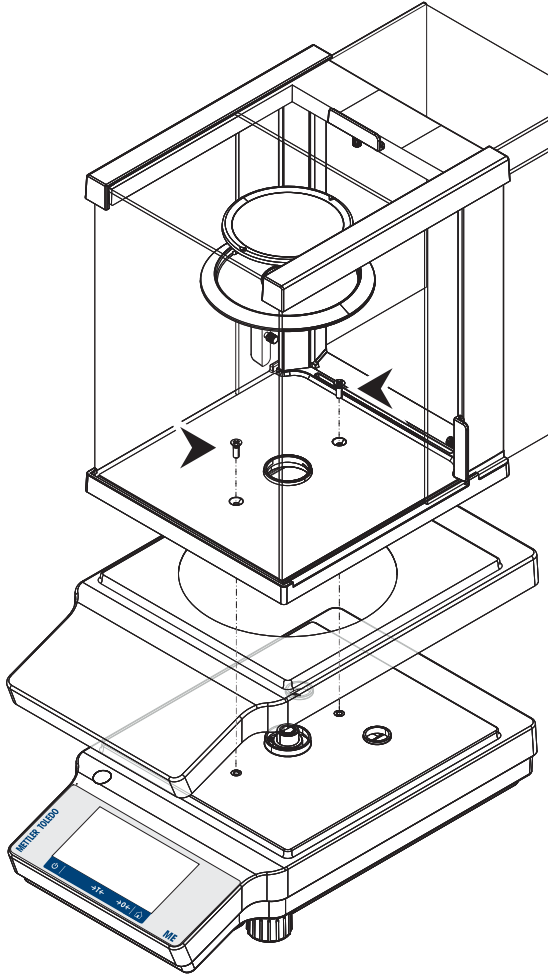
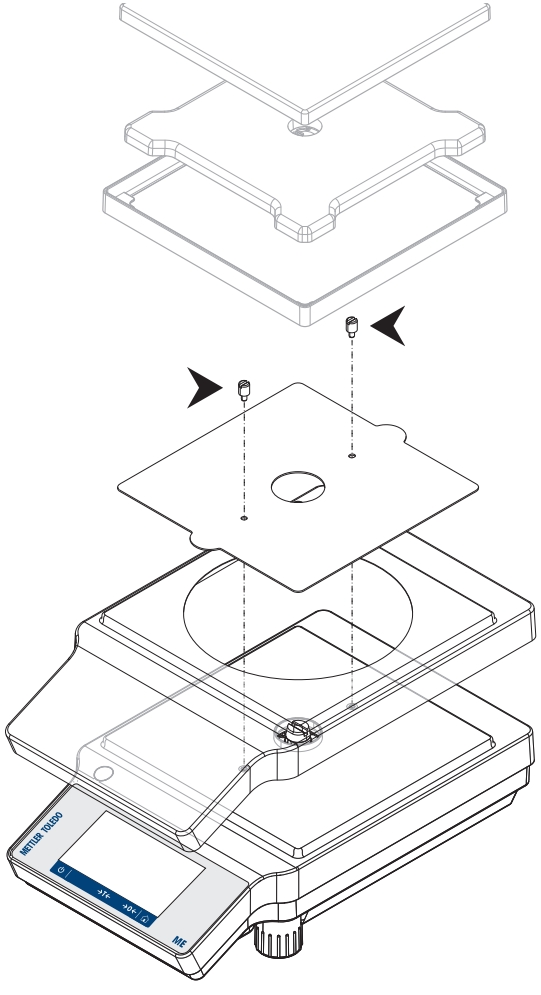
Balances with readability of 0.1 mg / 1 mg	Balances with readability of 0.01 g / 0.1 g
<p data-bbox="296 287 869 383">Install the protective cover according to the illustrations below, using a screwdriver Philips No. 2.</p> 	<p data-bbox="869 287 1444 383">Install the protective cover according to the illustrations below, using a flat-head screwdriver.</p> 

## 4.4 Selecting the location

Your balance is a sensitive precision instrument; the location where it is placed will have a profound effect on the repeatability and accuracy of weighing results. Choose a stable surface that is as horizontal as possible. The surface must be able to safely carry the weight of a fully loaded balance.

Observe ambient conditions (see Technical Data).

Avoid the following:

- Direct sunlight
- Air drafts (e.g. from fans or air conditioners)
- Temperature fluctuations
- Vibrations

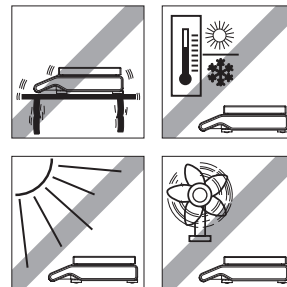

## 4.5 Connecting the instrument

The balance is supplied with a universal AC/DC adapter or with an AC/DC adapter with a country-specific power cable. The power supply is suitable for all line voltages in the range: 100 - 240 VAC, 50/60 Hz. For detailed specifications, **see** [Technical Data ▶ 83].

### Note

Allow the balance to warm up for 30 minutes (0.1 mg models need 60 minutes) to adapt itself to the ambient conditions.

Connect the AC/DC adapter to the connection socket on the back of your balance and to the power line.

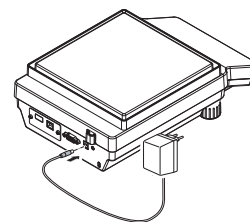

### Attention

- Check if the local power supply falls within this range. If this is not the case, under no circumstances connect the AC/DC adapter to the power supply, but contact a METTLER TOLEDO representative.
- The power plug must be accessible at all times.
- Prior to use, check the power cable for damage.
- Route the cable in such a way that it cannot be damaged or cause a hindrance when working.
- Ensure that no liquid ever comes into contact with the AC/DC adapter.

## 4.6 Leveling the balance

Exact horizontal positioning and stable installation are prerequisites for repeatable and accurate weighing results.

### Note

To compensate for small irregularities or inclinations ( $\pm 2\%$ ), the instrument must be leveled and adjusted each time it is moved to a new location. There are two adjustable leveling feet to compensate for slight irregularities in the surface of the weighing bench.

### Leveling the balance

- Adjust the two front leveling feet until the air bubble comes to rest exactly in the middle of the glass:

Air bubble at	"12 o'clock"	turn both feet clockwise
Air bubble at	"3 o'clock"	turn left foot clockwise, right foot counterclockwise
Air bubble at	"6 o'clock"	turn both feet counterclockwise
Air bubble at	"9 o'clock"	turn left foot counterclockwise, right foot clockwise

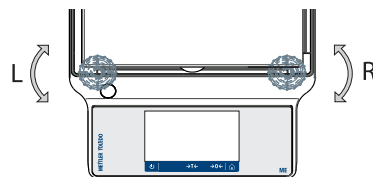

## 4.7 Switching on the balance

### Switching on the balance for the first time

- 1 Remove any load from the weighing pan.
- 2 Connect the balance using the AC/DC adapter to the mains.
  - ⇒ After the start screen has disappeared, the balance starts with the application home screen.

After the balance has switched on for the first time, it can be switched on by pressing long on [⏻].

### Note

When the balance is switched on for the first time, the home screen of the application **Weighing** opens. If the balance is switched on again, it always starts with the home screen of the application that was last used before switching off.

## 4.8 Switching off the balance

- 1 Press on [⏻] and hold until the dialog **Switch-off** appears.
- 2 Tap on [✓].
  - ⇒ the balance switches off and goes into standby mode.

### Note

- After switching on from standby mode, the balance needs no warm-up time and is immediately ready for weighing.
- If the balance has been switched off manually, the display is off.
  - To completely switch off the balance, it must be disconnected from the power supply.

## 4.9 Zeroing

- 1 Unload the balance.
  - 2 Press [→0←] to set the balance to zero.
- All weight values are measured in relation to the zero point.

### Note

Press [→0←] before starting the weighing process.



## 4.10 Taring

- 1 Tap on [**→0←**] to set the balance to zero.
- 2 Place the empty container on the balance.  
⇒ The weight is displayed.
- 3 Press [**→T←**] to tare the balance.  
⇒ The status information field on the left side of the screen shows **Net** and the weighing value field shows **0.000 g**.

## 4.11 Transporting the balance

Switch off the balance and remove the power cable and any interface cable from the balance. Refer to the notes in section [Selecting the location ▶ 21] regarding the choice of an optimal location.

### Transporting over short distances



#### CAUTION

##### For balances with a draft shield:

Never lift the balance by its glass draft shield. The draft shield is not sufficiently fastened to the balance.

### Transporting over long distances



#### CAUTION

If you would like to transport or ship your balance over long distances, **use the complete original packaging.**

#### Note

For transporting the balance over a long distance, we recommend to use the transport case, **see** Accessories and Spare parts.

## 4.12 Weighing Below the Balance

The balances are equipped with a hanger for carrying out weighings below the work surface (weighing below the balance).

#### CAUTION

Do not place the balance on the pan support location bolt.

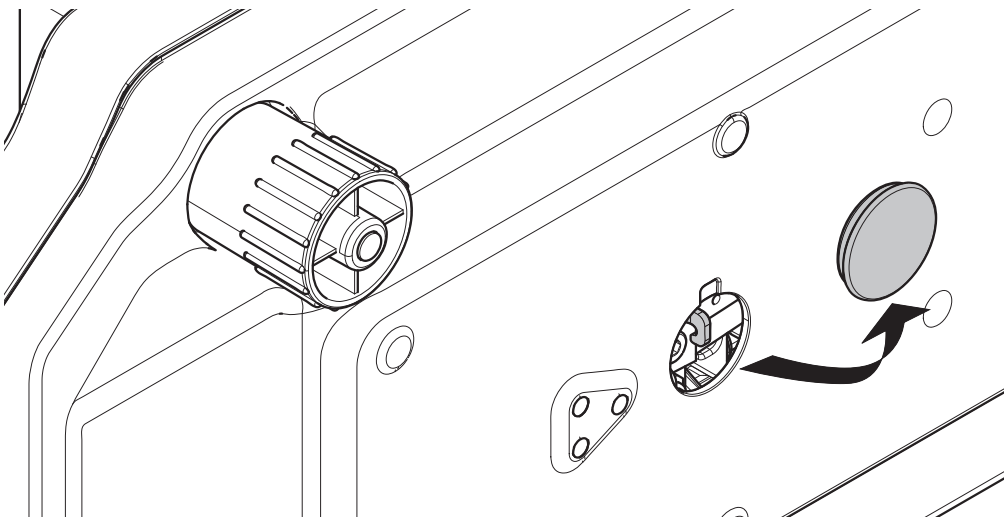

- 1 Switch off the balance and remove the power cable and any interface cable from the balance.
- 2 Remove weighing pan, pan support and draft shield element if present.
- 3 Turn the balance carefully on its side.
- 4 Remove the cap. Keep it for later use.
- 5 Turn the balance to its normal position and simply reinstall all components in the reverse order.

## **4.13 General requirements**

### **4.13.1 Warming up the balance**

Before working with the balance, it must be warmed up in order to obtain accurate weighing results. To reach operating temperature, the balance must be connected to the power supply for at least:

- 30 minutes for balances with a readability of 1 mg to 0.1 g.
- 60 minutes for balances with a readability of 0.1 mg and higher.

### **4.13.2 Adjusting the balance**

To obtain accurate weighing results, the balance must be adjusted to match the gravitational acceleration at its location and depending on the ambient conditions. After reaching the operation temperature, an adjustment is necessary in the following cases:

- Before the balance is used for the first time.
- After reaching the operating temperature (only for balances with FACT).
- When the balance was disconnected from the power or in case of power failure.
- After significant environmental changes (e. g. temperature, humidity, air draft or vibrations)
- At regular intervals during weighing service.

## 5 Weighing Made Simple

This section describes how to perform a simple weighing. In addition, the basic concept of the navigation and the basic functions of the balance are explained.

### 5.1 Main settings and activities at a glance

The diagram below provides an overview of the main settings of an application (in this example, **Weighing**). Depending on the application, the selectable options and their content can differ. Every application is based on this concept.

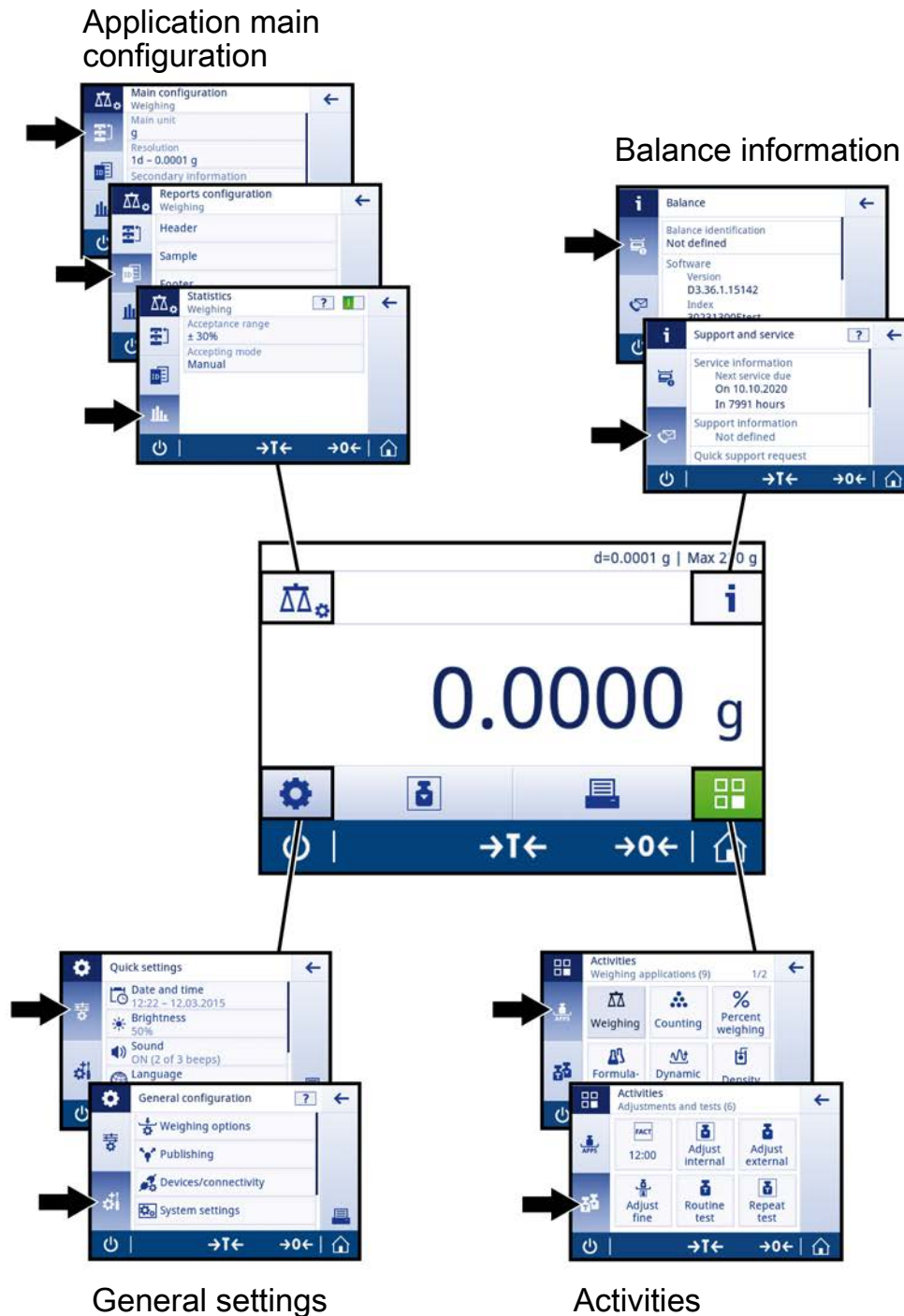

## 5.2 Navigation on the touch screen

To interact with the balance, use the screen and the operating keys at the bottom of the screen. The navigation on the screen is similar to the navigation on a smart phone or tablet PC.

### 5.2.1 Opening an application

To open settings or applications, tap with your finger on the symbol of the application (e.g. [  ] Weighing).

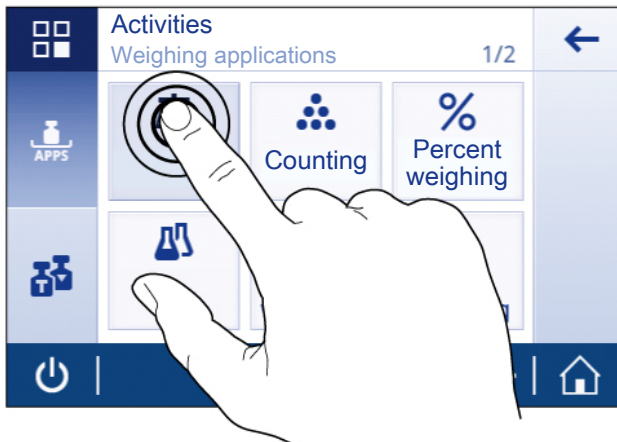

### 5.2.2 Scrolling

When the options are too numerous to be shown on one screen, a blue bar on the right side appears. This means that the user can scroll up and down. For scrolling, simply place your finger somewhere in the list and drag it up or down.

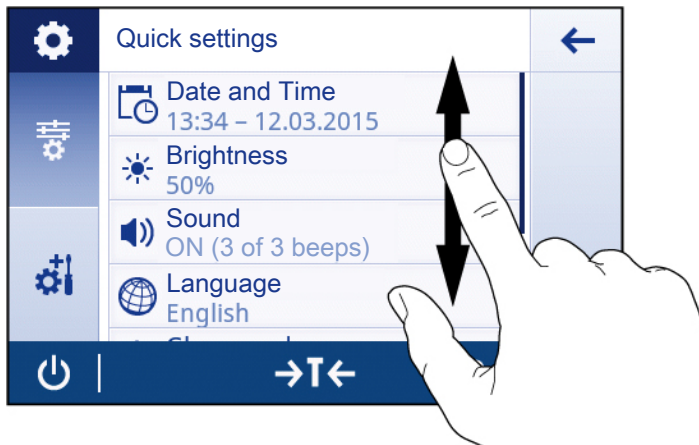

### 5.2.3 Using shortcuts

To simplify navigation on the capacitive color TFT touch screen, there are a few shortcuts that allow quick access to the most important areas of the balance. The weighing value field on the application home screen for example works as a shortcut (see diagram below), so does the weighing unit next to the weighing value field. Depending on the application, there may be other shortcuts that can be used.

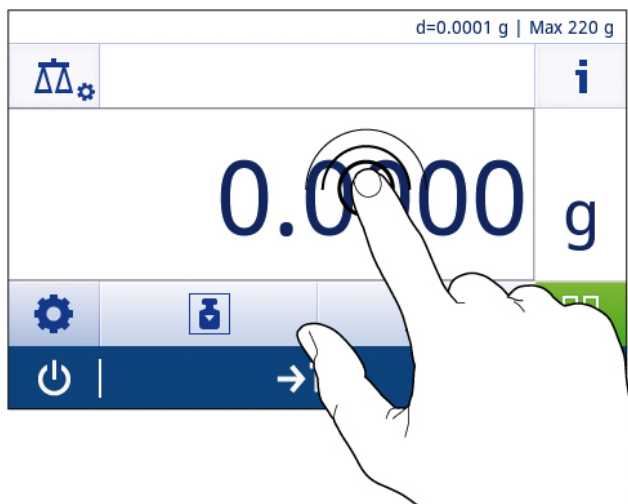

#### Note

Every setting that can be changed directly via shortcut, can also be changed in the main configuration settings of the application.

### 5.3 Performing a simple weighing

When you switch on the balance for the first time, the home screen of the application **Weighing** opens automatically. If the balance was used already, the last used application before the balance was switched off opens. If another application is running, switch to the application **Weighing**.

#### Navigation:

[Apps] > [Apps] **Activities - Weighing applications** > [Balance] **Weighing**

1 Press [→0←] to zero the balance or [→T←] to tare the balance.

⇒ The initial screen looks like this:



2 Place a sample on the weighing pan.

⇒ The instability symbol  appears at the left side of the screen and the value in the weighing value field becomes **light blue**.



⇒ After a short period of time, the weighing pan is stable. The instability symbol  disappears and the value in the weighing value field becomes **dark blue** again.



⇒ The weighing process is finished. The result appears on the screen.

## 5.4 Switching the weighing unit

There are several weighing units available. The default value is country-specific.

The weighing unit can be chosen via the main configuration of the current application or via shortcut. This example describes how to change the weighing unit via shortcut.

- 1 Tap on the weighing process unit (shortcut) **gram (g)**.



⇒ the screen **Main unit** opens.

- 2 Put your finger somewhere in the list and drag up to scroll down.

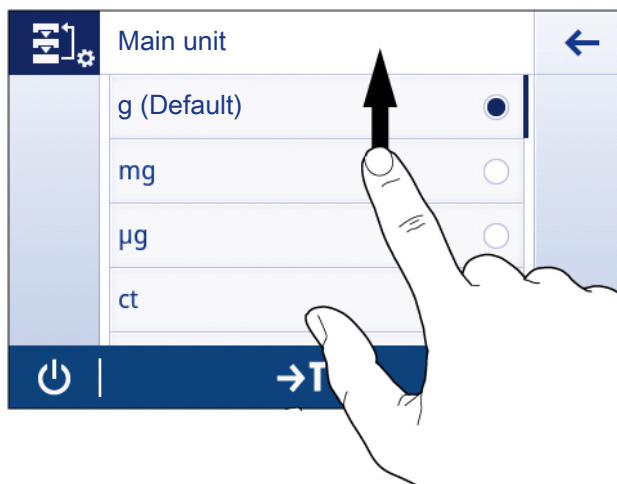

- 3 Choose another weighing unit (e.g. **ounce (oz)**) by tapping on it.



4 Tap on [✓] to confirm the chosen weighing unit.



⇒ The weighing unit **gram (g)** has been changed to **ounce (oz)**.

**Note**

With approved balances, this menu topic has a fixed setting and cannot be changed.

## 5.5 Changing the resolution

There are several resolutions available. The default resolution is instrument-specific.

The resolution can be changed as follows:

- 1 Tap on the weighing value field.



- 2 Tap on **10d - 0.001 g**.

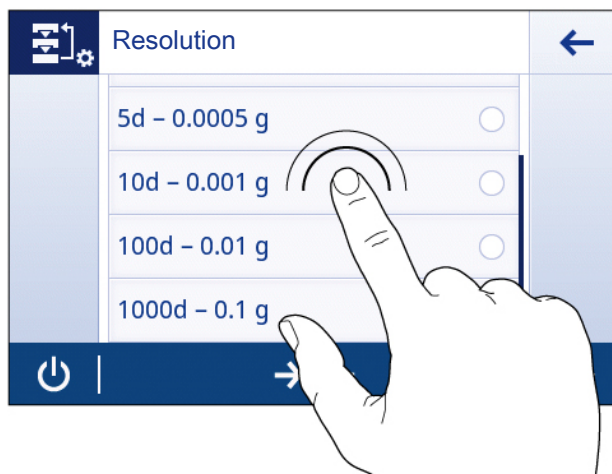

- 3 Confirm the chosen resolution by tapping on [✓].



⇒ The resolution has been changed.

## 5.6 Application settings

Each application can be defined manually with its application settings. Chose the application and tap on the application settings symbol in the upper left corner to define the application (e.g. [%a] in the application **Percent weighing**).

The available options can differ depending on the application. Most applications do have the following options:

-  **Main configuration**
-  **Reports configuration**
-  **Statistics**

### 5.6.1 Main configuration

In this section, the current application can individually be defined. Depending on the application the available options can differ.

#### Note

More information about the available options can be found in the activities section.

### 5.6.2 Reports configuration

In this section, the report options can be configured.

#### Note

The available options are model-specific and can differ depending on the application.

#### Header

The following options can be defined:

Parameter	Explanation	Values
<b>Date, time</b>	Defines if the date and time are shown on the report.	<b>ON</b>   <b>OFF</b> *
<b>Balance type</b>	To define if the balance type is shown on the report.	<b>ON</b>   <b>OFF</b> *
<b>Serial number (SNR)</b>	Defines if the serial number is shown on the report.	<b>ON</b>   <b>OFF</b> *
<b>Balance ID</b>	Defines if the balance ID appears.	<b>ON</b>   <b>OFF</b> *
<b>Leveling information</b>	Defines if the leveling information appear in the report.	<b>ON</b>   <b>OFF</b> *
<b>MinWeigh Information</b>	Defines if the MinWeigh information appear in the report.	<b>ON</b>   <b>OFF</b> *
<b>ID 1</b>	Defines if ID 1 appears on the report.	<b>ON</b>   <b>OFF</b> *
<b>ID 2</b>	Defines if ID 2 appears on the report.	<b>ON</b>   <b>OFF</b> *
<b>ID 3</b>	Defines if ID 3 appears on the report.	<b>ON</b>   <b>OFF</b> *
<b>Signature line</b>	Defines if the signature line is shown on the report.	<b>ON</b>   <b>OFF</b> *
<b>Empty lines</b>	Defines the number of empty lines.	<b>ON</b> (1...99)   <b>OFF</b> *

\* Factory setting

## Sample

The following options can be defined:

Parameter	Explanation	Values
<b>ID 4</b>	Defines if ID 4 is shown on the report.	<b>ON   OFF*</b>
<b>Gross/Tare</b>	Defines if <b>Gross/Tare</b> is shown on the report.	<b>ON   OFF*</b>
<b>Additional unit</b>	Defines if an additional unit is shown on the report.	<b>ON   OFF*</b>

\* Factory setting

## Footer

The following options can be defined:

Parameter	Explanation	Values
<b>Date, time</b>	Defines if date and time is shown on the report.	<b>ON   OFF*</b>
<b>Signature line</b>	Defines if the signature line is shown on the report.	<b>ON   OFF*</b>
<b>Empty lines</b>	Defines the number of empty lines.	<b>ON (1...99)   OFF*</b>

\* Factory setting

### 5.6.2.1 Working with IDs

Identifications (IDs) contain descriptive text for measurements, which enables samples to be easily allocated to specific tasks or customers. This feature defines identifications in order to comment measurements, such as company ID, batch ID or sample ID.

Identifications must be defined in the section **Reports configuration** in the application settings. Usage and definition of the ID differ depending on the application the ID is used for.

#### Identification dialog screen

The Identification dialog screen can slightly differ depending on the application in which the ID is used. The dialog screen always consists of two parts:

- The table with the ID definitions on the upper part of the screen.
- The **Workflow options** on the lower part of the dialog screen.

### 5.6.2.2 Defining an ID

- 1 Open an application (e. g. **Weighing**).
- 2 Tap on the application settings symbol on the upper left corner.
- 3 Tap on **[ID] Reports configuration**.
- 4 Tap on **[Header]**
- 5 Tap on **ID 1**.  
⇒ The input dialog **ID 1** opens. The input dialog is inactive.
- 6 Activate **ID 1** with the switch in the title bar.  
⇒ The input dialog **ID 1** is activated.
- 7 Define **ID 1 - Label**.
- 8 Tap on **[✓]** to confirm the definition.
- 9 Define **ID 1 - Value**.
- 10 Tap on **[✓]** to confirm the definition.  
⇒ The screen **ID 1** shows the values for **ID - Label** and **ID - Label**.
- 11 Tap on **[✓]** to accept the defined values.  
⇒ The screen **Header Reports configuration** shows the defined ID.
- 12 Tap on **[✓]** to confirm.  
⇒ The screen **Header Reports configuration** opens.
- 13 Tap on **[✓]** to confirm.

#### Note

The maximum length of an ID is 12 characters.

The picture below shows an example of defined IDs. IDs 1-3 are defined.

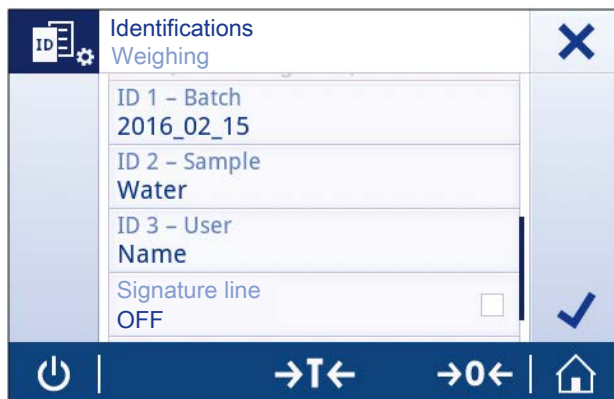

### 5.6.2.3 Workflow handling options

The workflow handling options differ depending on the application in which they are used. The following functions are available:

- **Autoincrement**
- **Input prompt**

#### **Autoincrement**

The function **Autoincrement** specifies that the last part of the ID is incremented with each use of that ID. There are two basic functions depending on how the ID is defined:

- If there is no counter in the ID, the system automatically adds a counter to the ID starting with 1 (e.g. the ID **Process** will be **Process1** in the next use).
- If a counter is part of the ID, the system automatically increments the ID starting at that counter (e.g. the ID **Process 1** will be **Process 2** in the next use).

#### **Note**

- The counter must be set at the end of the ID, otherwise the system does not recognize the number as a counter (e.g. in **567Apple** the system does not recognize **567** as a counter).
- If the ID has no counter and a maximum length of 12 characters, the last few characters will be overwritten by the counter.

#### **Assign to sample**

If the option **Assign to sample** is activated, the ID will be used for each sample.



#### **Input prompt**

The function **Input prompt** can be used for every ID. If the function **Input prompt** is activated, the ID will be prompted on the display before it is used. The user can decide whether to use the default value that has been defined with the ID or to define an individual value.

### 5.6.3 Statistics

The function **Statistics** generates statistics for a series of values. The function **Statistics** is not available for the applications **Totaling** and **Formulation**.

#### Defining Statistics

- 1 Open an application (e.g. **Weighing**).
- 2 Tap on the main configuration symbol of the application.  
⇒ The main configuration screen opens.
- 3 Tap on [].  
⇒ The screen **Statistics** opens.
- 4 Activate the function **Statistics**.
- 5 Define the available options.
- 6 Tap on [] to confirm the adjustments.

#### Statistics configuration

The following options can be defined:

Parameter	Explanation	Values
<b>Acceptance range</b>	To define the acceptable deviation in relation to the average value.	1%...100% (30%*)
<b>Accepting mode</b>	To define if a weight sample is added automatically to the result.	<b>Manual*</b>   <b>Automatic</b>

\* Factory setting

## 6 Activities

The section **Activities** can be opened by tapping on .

The section **Activities** includes the following two sub-sections:

- **Activities - Weighing applications**
- **Activities - Adjustments and tests**

### 6.1 Activities - Weighing applications

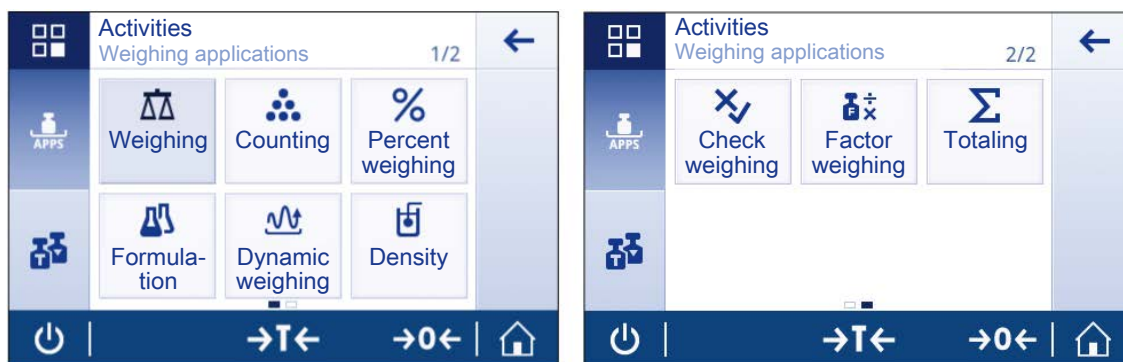

**Activities - Weighing applications** includes the following applications:

- **Weighing see** [Weighing ▶ 39] and [Weighing Made Simple ▶ 26]
- **Counting see** [Counting ▶ 40]
- **Percent Weighing see** [Percent Weighing ▶ 44]
- **Formulation see** [Formulation ▶ 46]
- **Dynamic Weighing see** [Dynamic Weighing ▶ 48]
- **Density see** [Density ▶ 50]
- **Check Weighing see** [Check Weighing ▶ 52]
- **Factor Weighing see** [Factor Weighing ▶ 56]
- **Totaling see** [Totaling ▶ 57]

#### Note

There is not enough space to show all the weighing applications on one screen. Scroll horizontally to reach the applications **Check weighing**, **Factor weighing** and **Totaling** on the second page.



## 6.1.1 Weighing

The application **Weighing** allows the user to perform simple weighings. For more information about the basic weighing functions see section [Weighing Made Simple ▶ 26].

### Navigation

 **Activities** >  **Activities - Weighing applications** >  **Activities - Weighing applications**

### Weighing – Main configuration

The following options can be defined:

Parameter	Explanation	Values
<b>Main unit</b>	To define the main unit of the weighing process.	Available units are model and country-specific.
<b>Secondary information</b>	To choose a secondary information that is displayed on the screen.	<b>Additional unit*</b> (the available units are model and country-specific)   <b>Current tare</b>
<b>Resolution</b>	To define the resolution of the weighing process.	Available resolutions are model-specific
<b>Target and tolerances</b>	<b>Target weight</b> To predefine a target weight. The value can be chosen manually or by weighing. <b>Upper tolerance</b> To define the upper tolerance. <b>Lower tolerance</b> To define the lower tolerance. <b>Note</b> If the value for <b>Target weight</b> , <b>Upper tolerance</b> or <b>Lower tolerance</b> has been defined, the option title <b>Target and tolerances</b> will be replaced by the defined values.	numerical or percentage values

\* Factory setting

## 6.1.2 Counting

The application **Counting** determines a specific number of pieces, based on pre-determined reference piece weight.

### Navigation

 **Activities** >  **Activities - Weighing applications** >  **Counting**

There are two counting modes available: **Advanced** and **Standard**. With the additional features of the mode **Advanced** the whole process is more comfortable and more secure due to an automatic workflow. The mode can be changed in the section **Counting – Main configuration**. The default mode is the mode **Advanced**.

### 6.1.2.1 Defining reference piece weight in Standard mode

To define the **Reference piece weight**, **Reference piece number** and **Reference weight** must successively be defined. The system will automatically navigate from one option to the other.

#### Defining Reference piece number

- 1 Tap on .  
⇒ The screen **Counting – Main configuration** opens.
- 2 Tap on [**Reference piece weight**].  
⇒ The dialog screen **Reference piece number** opens.
- 3 Delete the value by tapping on [**x**].
- 4 Enter the number of reference pieces.
- 5 Tap on [**✓**] to confirm the defined reference piece number.

#### Note

The reference piece number must be a natural number between 1 and 999.

#### Defining Reference weight

**Reference weight** can be defined manually by entering the weight of the reference pieces or by weighing the reference pieces.

#### Defining Reference weight manually

- 1 Delete the reference weight by tapping on [**x**].
- 2 Enter the new reference weight.
- 3 The reference unit can be changed by tapping in the sensitive area at the right side of the input field.
- 4 Confirm the new value by tapping on [**✓**].  
⇒ The reference piece weight has been defined.
- 5 Confirm the new reference piece weight by tapping on [**✓**].

#### Defining Reference weight by weighing

- 1 Tap on .
- 2 Place the reference weight on the weighing pan.
- 3 Tap on [**✓**] to confirm the weight.
- 4 Tap on [**✓**] to confirm the new reference weight.  
⇒ The screen **Counting – Main configuration** opens.
- 5 Tap on [**✓**] to confirm the configuration.

### 6.1.2.2 Defining reference piece weight in Advanced mode

To define the **Reference piece weight**, **Reference piece number** and **Reference weight** can be defined directly via the shortcuts.

#### Defining Reference piece number

- 1 Activate option **Advanced** and return to the home screen.
- 2 Tap on [**1 piece**] in the work title bar.  
⇒ A dialog screen opens.
- 3 Tap on [**Piece number**].
- 4 Tap on [**✕**] to delete the value.
- 5 Enter the number of reference pieces.
- 6 Tap on [**✓**] to confirm the defined number.  
⇒ The defined value for the option **Reference piece number** appears in the work title bar.

#### Defining Reference piece weight manually

- 1 Tap on [**Piece weight**] in the work title bar.  
⇒ The screen **Reference piece weight** opens.
- 2 Tap on [**✕**] to delete the value.
- 3 Enter the new value.
- 4 Tap on [**✓**] to confirm the defined value.  
⇒ The defined value for the option **Reference piece weight** appears in the work title bar.

#### Defining Reference piece weight by weighing

- If there is no reference weight defined yet, the work title bar shows **Piece weight Not defined**.
- 1 Place the reference sample weight on the weighing pan.
  - 2 Depending if the option **Reference mode** is set on **Automatic** (default value) or on **Manual**, the value will be automatically accepted or must be confirmed.  
⇒ The balance returns to the application main screen and shows the defined value for the option **Reference piece weight** in the work title bar.

#### Note

When the reference weight has been defined in the mode **Advanced** it appears on the right side of the work title bar. The reference weight can be changed in the **Main configuration** under **Reference piece weight** or with the shortcut on the left side of the work title bar.

#### Note

The reference piece number must be a natural number between 1 and 999.

The following screen shot shows the home screen of the application. The work title bar displays the defined **Reference piece number** and **Manual piece weight** that can be used as shortcuts.

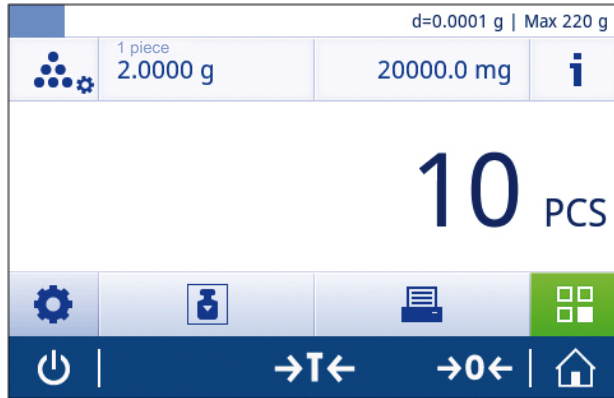

**Note**

A fixed minimum reference piece number of 10 and inactive reference weight options are pre-determined for approved balances for some selected countries.

### 6.1.2.3 Counting - Main configuration

The following options can be defined:

Parameter	Explanation	Values
<b>Counting mode</b>	To choose the options for <b>Counting mode</b>	<b>Advanced*</b>   <b>Standard</b>
<b>Reference piece weight</b>	To define the number and the weight of the reference piece/s.	1...999 (10*)
<b>Secondary information</b>	To choose a secondary information that is displayed on the screen.	<b>Additional unit*</b> (the available units are model and country-specific)   <b>Current tare</b>
<b>Target and tolerances</b>	Defines the options for <b>Target and tolerances</b> .	<b>ON</b>   <b>OFF*</b>

\* Factory setting

#### Advanced mode options

The following options can be defined in the advanced mode:

Parameter	Explanation	Values
<b>Reference mode</b>	<p><b>Automatic</b> The next stable weight is automatically accepted as reference weight according to the defined piece number.</p> <p><b>Manual</b> Reference can be defined manually.</p>	<b>Automatic*</b>   <b>Manual</b>
<b>Auto clear reference</b>	The current value of the option <b>Reference piece weight</b> will automatically be deleted after zeroing or after removing all loaded weights from the weighing pan.	<b>ON</b>   <b>OFF*</b>
<b>Reference optimization</b>	With this option, the current reference will continuously be optimized while working by accepting additional pieces automatically or manually.	<b>ON</b>   <b>OFF*</b>
<b>Reference check</b>	Defines the options for <b>Reference check</b> .	<b>ON</b>   <b>OFF*</b>
<b>Accuracy information</b>	With this option the counting accuracy can be shown.	<b>ON</b>   <b>OFF*</b>

\* Factory setting

### 6.1.3 Percent Weighing

With the application **Percent Weighing** a sample weight can be checked as a percentage to a reference target weight.







#### Navigation

 **Activities** >  **Activities - Weighing applications** >  **Percent Weighing**





#### Defining Reference weight

There are two possible ways to define the reference weight: the reference weight can be defined manually by entering the value or by weighing the reference weight.

#### Defining the reference weight by weighing

- 1 Tap on .  
⇒ The screen **Percent weighing – Main configuration** opens.
- 2 Tap on **Reference weight**.
- 3 Tap on .
- 4 Press  to zero the balance.
- 5 Place the reference weight on the weighing pan.
- 6 Tap on  to accept the value of the reference weight.  
⇒ The screen **Reference weight** reappears.
- 7 Tap on  to accept the reference weight.
- 8 Tap on  to accept the reference weight and to return to the application home screen.

#### Defining the Reference Weight manually

- 1 Tap on .
- 2 Tap on **Reference weight**.
- 3 Delete the default value by tapping on .
- 4 Enter the value of the reference weight.
- 5 Tap on  to accept the reference weight.
- 6 Tap on  again to confirm.  
⇒ The reference weight has now been defined and will be shown in the work title bar.

The screen shot shows the home screen of the application **Percent Weighing**. The work title bar displays a defined reference weight of 200 g that can be used as shortcut.



### Percent weighing – Main configuration

The following options can be defined:

Parameter	Explanation	Values
<b>Reference weight</b>	To define the reference weight manually or by weighing.	Available range is model-specific.
<b>Secondary information</b>	To choose a secondary information that is displayed on the screen.	<b>Additional unit*</b> (the available units are model and country-specific)   <b>Current tare</b>

## 6.1.4 Formulation

The application **Formulation** allows the user to:

- Weigh-in (add and store) up to 999 individual component weights and display the total.
- Tare/pre-tare and store up to 999 container weights and display the total.
- fill up the sum of all component net weight values by adding a further component to a higher value.

### Note

Total number of containers + component weights  $\leq$  999.

### Navigation

 **Activities** >  **Activities - Weighing applications** >  **Formulation**



### Performing Formulation

- 1 Press [ $\rightarrow$  **0**  $\leftarrow$ ] to zero the balance
- 2 If a container is used: Place container on the weighing pan and press [ $\rightarrow$  **T**  $\leftarrow$ ] to tare the balance.  
 $\Rightarrow$  If the balance is tared, the status information field shows **Net**.
- 3 Place the first component weight.  
 $\Rightarrow$  The weighing value field shows the value of the first component weight.
- 4 Tap on [**+**] to add the first component weight.
- 5 Place the second component weight.  
 $\Rightarrow$  The weighing value field shows the value of the second component weight.
- 6 Tap on [**+**] to add the second component weight.
- 7 Continue adding components until all the components are weighed.

### Defining Fill up sample

With the function **Fill up sample** an additional component weight can be added to the total weight of all components to reach a desired target weight.

- The weighing value field shows the total net weight.

- 1 Tap on [].
- 2 Place the fill up sample.
- 3 Tap on [] to confirm.

### Discard value

The last weighing result can be discarded as follows:

- 1 Tap on [**-**].  
 $\Rightarrow$  The dialog screen **Confirm discard** opens. It is an overview of all the weighing results within the current weighing process.
- 2 Tap on [] to discard the last weighing result.

### CAUTION

Discard is only possible until the last time the balance has been tared.



## Display results

When the weighing process is finished, the results can be shown as follows:

- 1 Tap on [■].
- 2 Tap on [📄] **View result**.

### Note

The results can also be displayed by using the shortcut in the work title bar.

### Note

Depending on the procedure, several containers can be used (number of used containers  $\leq$  999).

## Pause the application

- 1 Tap on [■].
- 2 Tap on [⏸] **Pause**.  
⇒ The application **Formulation** is paused and another application can be used in the meantime.
- 3 Open the application **Formulation** again.
- 4 Tap on [▶].  
⇒ The process can be continued.

## Terminate the application

- 1 Tap on [■].
- 2 Tap on [✓] **Finish and discard data**.  
⇒ The home screen of the application **Formulation** opens.

## Formulation – Main configuration

The following options can be defined:

Parameter	Explanation	Values
<b>Main unit</b>	To define the main unit.	Available units are model and country-specific.
<b>Resolution</b>	To define the resolution of the weighing process.	Available resolutions are model-specific.

## 6.1.5 Dynamic Weighing

The application **Dynamic Weighing** determines the weights of unstable samples or when the weighing process is being executed under unstable ambient conditions. The balance calculates the weight as an average of a number of weighing operations over a defined time.

### Navigation

 **Activities** >  **Activities - Weighing applications** >  **Dynamic Weighing**

### Defining Measuring time

- 1 Tap on .  
⇒ The screen **Dynamic weighing – Main configuration** opens.
- 2 Tap on **[Measuring time]**.  
⇒ The dialog screen **Measuring time in seconds** opens.
- 3 Tap on **[x]** to delete the value in the input field.
- 4 Enter a value between 3 and 120 seconds.
- 5 Tap on **[✓]** to confirm the entered value.  
⇒ The screen **Dynamic weighing – Main configuration** opens.
- 6 Tap on **[✓]** to confirm the defined measuring time.

### Note

The displayed measuring time on the application home screen can be used as shortcut to define the measuring time.

### Defining Start mode

- 1 Tap on .
- 2 Tap on **Start mode**.
- 3 Chose **Automatic** or **Manual**.
- 4 Tap on **[✓]** to confirm the chosen option.
- 5 Tap on **[✓]** again.  
⇒ The home screen of the application **Dynamic Weighing** opens again.

### Performing Dynamic Weighing

When the measuring time and the start mode have been defined, the dynamic weighing process can be started.

- 1 Press **[→0←]** to zero the balance.
- 2 If using a container: place container on the weighing pan and press **[→T←]** to tare the balance.
- 3 Place sample weight.  
⇒ If the option **Start mode** is set to **Automatic**, the weighing process start automatically with relative stability.  
⇒ If the option **Start mode** is set to **Manual**, tap on **[▶]** to start the weighing process.  
⇒ The weighing process starts. The defined measuring time in the work title bar is counting down.

When the weighing process has finished, the screen looks as follows:

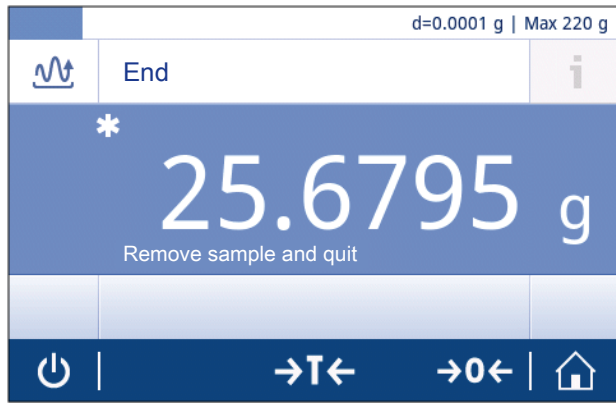

**Note**

The weighing process will automatically be aborted when an overload or underload is detected.

**Dynamic weighing – Main configuration**

The following options can be defined:

Parameter	Explanation	Values
<b>Measuring time</b>	To define the measuring time in seconds.	3...120 (3 seconds*)
<b>Start mode</b>	To define the option <b>Start mode</b> .	<b>Automatic*</b>   <b>Manual</b>
<b>Main unit</b>	To define the main weighing unit.	Available units are model and country-specific.
<b>Resolution</b>	To define the resolution of the weighing process.	Available resolutions are model-specific.
<b>Secondary information</b>	To choose a secondary information that is displayed on the screen.	<b>Additional unit*</b> (the available units are model and country-specific)   <b>Current tare</b>

\* Factory setting

## 6.1.6 Density

The application **Density** allows to determine the density of solid bodies and liquids. Determination of the density uses the Archimedes principle according to which a body immersed in a fluid undergoes an apparent loss in weight which is equal to the weight of the fluid it displaces.





### Note

To determine the density of solid bodies, we recommend to use the optional density kit which contains all the attachments and aids needed for convenient and precise density determination. To determine the density of liquids, you additionally need a sinker which you can also obtain from your METTLER TOLEDO dealer.





### Navigation

[] **Activities** > [] **Activities - Weighing applications** > [] **Density**

### Density determination of solids

- 1 Tap on [] to open the menu **Density – Main configuration**.
- 2 Open the menu **Method**.
- 3 Choose the option **Solid**.
- 4 Tap on [].
  - ⇒ When the option **Solid** has been activated (default value), the option **Auxiliary liquid** appears in the list.
- 5 Tap on **Auxiliary liquid**.
- 6 Define the **Auxiliary liquid** that is used. Chose between **H2O** for distilled water, **Ethanol** or **Free...** for a freely definable auxiliary liquid.
- 7 Tap on [] to confirm the chosen Auxiliary liquid.
  - ⇒ The chosen Auxiliary liquid defines the next steps:
- 8 **Temperature in °C** must be defined for the options **Ethanol** and **H2O**.
- 9 **Auxiliary liquid name** and **H density in g/cm<sup>3</sup>** must be defined for the option **Free...**
- 10 Tap on [].
  - ⇒ The application home screen opens.
  - ⇒ The balance is prepared for the density determination of solids.

### Performing a density determination for solids

- The balance has been configured for the density determination of solids.
- 1 Tap on [] to start the process.
  - 2 Place the weight on the weighing pan.
  - 3 Tap on [] to accept.
  - 4 Immerse sample weight into the liquid.
  - 5 Tap on [] to accept.
    - ⇒ A report shows the results of the process.
  - 6 Tap on [] to accept and to finish the procedure.

## Density determination for liquids

- 1 Tap on [].
- 2 The menu **Density – Main configuration** opens.
- 3 Open the menu **Method**.
- 4 Chose the option **Liquid**.
- 5 Tap on [] to confirm.  
⇒ When the option **Liquid** has been activated, the option **Sinker volume** appears in the list.
- 6 Open the menu **Sinker volume**.
- 7 Tap on [] to delete the value.
- 8 Define the displacement volume of the sinker.
- 9 Tap on [] to confirm.
- 10 Tap on [] to confirm the configurations.  
⇒ The balance returns to the application home screen.

## Performing density determination of liquids

- The balance has been configured for the density determination of liquids.
- 1 Tap on [] to start the process.
  - 2 Place the sinker on the weighing pan.
  - 3 Tap on [] to accept.
  - 4 Immerse the sinker.
  - 5 Tap on [] to accept and to finish the procedure.  
⇒ A report shows the results of the process.

## Density - Main Configuration

The following options can be defined:

Parameter	Explanation	Values
<b>Method</b>	Depending if the weight type is solid or liquid.	<b>Solid*</b>   <b>Liquid</b>
<b>Auxiliary liquid</b>	To chose the auxiliary liquid.	<b>H2O*</b>   <b>Ethanol</b>   <b>Free...</b>
<b>Sinker volume</b>	This option is only available with the method <b>Liquid</b> activated.	(0.1...500.0 cm <sup>3</sup> )
<b>Main unit</b>	To define the main unit of the weighing process.	Available units are model and country-specific.

\* Factory setting

## 6.1.7 Check Weighing

The application **Check Weighing** allows the user to check the deviation of a sample weight within a tolerance limit to a reference target weight. The target weight can be determined manually or by weighing; the tolerance limit must be defined manually.





### Navigation

[] **Activities** > [] **Activities - Weighing applications** > [] **Check Weighing**

Before performing a check weighing, the following options can be defined:

- **Target weight**
- **Upper tolerance limit**
- **Lower tolerance limit**
- **Tolerance threshold**

### Defining the target weight manually by entering the nominal weight

- 1 Tap on [].  
⇒ The screen **Check weighing - Main configuration** opens.
- 2 Tap on [**Target and tolerances**].
- 3 Tap on [] **Target weight**.
- 4 Tap on [] to delete the default value.
- 5 Enter the value of the target weight.
- 6 Tap on [] to confirm the defined nominal weight.
- 7 Tap on [].  
⇒ The application home screen opens, showing the target weight in the work title bar.

### Defining the target weight by weighing

- 1 Tap on [X<sub>o</sub>].  
⇒ The screen **Check weighing - Main configuration** opens.
- 2 Tap on [**Target and tolerances**].
- 3 Tap on [⊕] **Target weight**.
- 4 Tap on [⚖] to open the weighing dialog.
- 5 Place the reference weight on the weighing pan.
- 6 Tap on [✓] to confirm the weighted target weight.
- 7 Tap on [✓] to confirm the target weight.
- 8 Tap on [✓] to confirm and close the main configurations.



### Defining the lower and upper limits manually by entering a percentage value or weight

- 1 Tap on [X<sub>o</sub>].  
⇒ The screen **Check weighing - Main configuration** opens.
- 2 Tap on [**Target and tolerances**].
- 3 Tap on [⊕] **Upper tolerance limit** or tap on [⊖] **Lower tolerance limit**.
- 4 Activate the option with the switch on the upper right side.
- 5 Tap on [x] to delete the default value.
- 6 Enter the tolerance limit.
- 7 Tap on [✓] to accept the new tolerance limit.
- 8 Tap on [✓] to confirm and close the main configurations.

### Defining Tolerance threshold

With the option **Tolerance threshold** a value limit can be set. If the value of the check weight below the defined threshold, it won't be checked.

- 1 Tap on [X<sub>o</sub>].  
⇒ The screen **Check weighing - Main configuration** opens.
- 2 Tap on **Tolerance threshold**.
- 3 Activate the option with the switch on the right upper side.
- 4 Tap on [x] to delete the value.
- 5 Define the value for **Tolerance threshold**.
- 6 Tap on [✓] to confirm the new value.
- 7 Tap on [✓] to confirm and to close the main configuration.

#### Note

The option **Tolerance threshold** always refers to the lower tolerance limit.

## Performing Check Weighing

After defining the target weight and the tolerance limits, the application **Check Weighing** can be performed. The weighing-in aid at the top bar provides a visual confirmation whether the sample falls within the defined tolerances.

In the example below, the defined target weight is 100.000 g and the tolerance limit is  $\pm 2.5\%$ . The sample weight is 97.0000 g.

- Place the sample weight on the weighing pan.
  - ⇒ The weight is stable and the instability symbol  disappears.
  - ⇒ The value is out of tolerance, the weighing-in aid bar and the weighing value field are red.

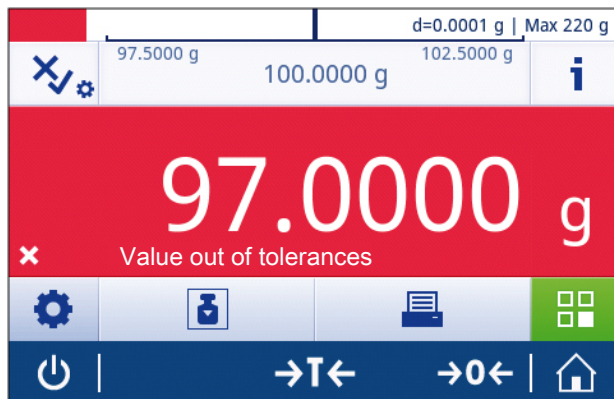

In the example below, the defined target weight is still 100.000 g and the tolerance limit is  $\pm 2.5\%$ . The sample weight is 99.0000 g.

- Place the sample weight on the weighing pan.
  - ⇒ The weight is stable and the instability symbol  disappears.
  - ⇒ The value is within tolerances, the weighing-in aid bar and the weighing value field are green.

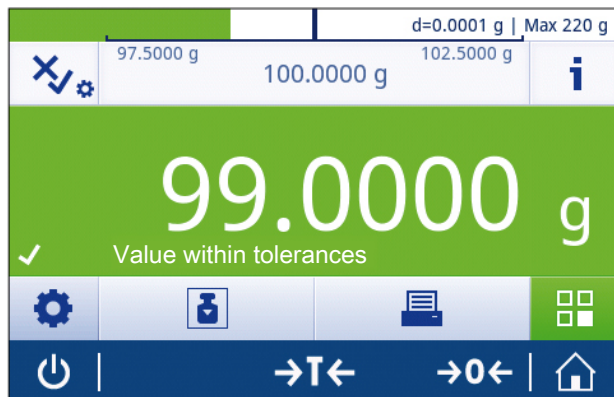

### Note

If the weight is below a defined tolerance threshold, the background color of the screen doesn't change.



## Check weighing - Main configuration

The following options can be defined:

Parameter	Explanation	Values
<b>Target and tolerances</b>	<p><b>Target weight</b> To predefine a target weight. The value can be chosen manually or by weighing.</p> <p><b>Upper tolerance</b> To define the upper tolerance.</p> <p><b>Lower tolerance</b> To define the lower tolerance.</p> <p><b>Note</b> If the value for <b>Target weight</b>, <b>Upper tolerance</b> or <b>Lower tolerance</b> has been defined, the option title <b>Target and tolerances</b> will be replaced by the defined values.</p>	numerical or percentage values
<b>Tolerance threshold</b>	To define the threshold. Values below the defined threshold are not being checked.	1%...100% (1%*)
<b>Within tolerance beeps</b>	To create an acoustic signal when the result is within tolerance.	<b>ON   OFF*</b>
<b>Main unit</b>	To define the main unit of the weighing process.	Available units are model and country-specific.
<b>Resolution</b>	To define the resolution of the weighing process.	Available resolutions are model-specific.
<b>Secondary information</b>	To choose a secondary information that is displayed on the screen.	<b>Additional unit*</b> (the available units are model and country-specific)   <b>Current tare</b>

\* Factory setting

### Note

The selectable weighing units and the resolution can differ depending on the balance model.

- Only those weight units allowed by the appropriate national legislation are selectable.
- With approved balances, this menu topic has fixed settings and cannot be changed.



## 6.1.8 Factor Weighing

The application **Factor Weighing** multiplies or divides a pre-defined factor by the measured weight value (in grams) and calculates it to a predefined number of decimal places.

### Navigation

 **Activities** >  **Activities - Weighing applications** >  **Factor Weighing**

### Defining Factor, step

- 1 Tap on .
  - ⇒ The screen **Factor weighing – Main configuration** opens.
- 2 Tap on [**Factor, step**].
  - ⇒ The dialog screen **Factor – Multiplication** opens.
- 3 Tap on [**x**] to delete the defined value.
- 4 Define **Factor**.
- 5 Tap on  to change the operation from Multiplication to Division or vice versa.
- 6 Tap on [**✓**] to confirm.
- 7 Tap on .
  - ⇒ The dialog screen **Step** opens.
- 8 Define **Step**.
- 9 Tap on [**✓**] to confirm.
- 10 Tap on [**✓**] again to confirm the defined adjustments.

### Note

The allowed range for the steps depends on the defined factor and the resolution of the balance.

### Factor weighing – Main configuration

The following options can be defined:

Parameter	Explanation	Values
<b>Factor, step</b>	To define the factor and the step.	<b>Factor   Step</b>
<b>Secondary information</b>	To choose a secondary information that is displayed on the screen.	<b>Additional unit*</b> (the available units are model and country-specific)   <b>Current tare</b>
<b>Target and tolerances</b>	<p><b>Target weight</b> To predefine a target weight. The value can be chosen manually or by weighing.</p> <p><b>Upper tolerance</b> To define the upper tolerance.</p> <p><b>Lower tolerance</b> To define the lower tolerance.</p> <p><b>Note</b> If the value for <b>Target weight</b>, <b>Upper tolerance</b> or <b>Lower tolerance</b> has been defined, the option title <b>Target and tolerances</b> will be replaced by the defined values.</p>	numerical or percentage values

\* Factory setting





## 6.1.9 Totaling

The application **Totaling** allows the user to weigh different samples, adding their weight values and to totalize them.

### Navigation

[] **Activities** > [] **Activities - Weighing applications** > [] **Totaling**



### Performing Totaling

- 1 Press [] to zero the balance.
- 2 If using a container: place empty container on the weighing pan and press [] to tare the balance.
- 3 Place the first weight.
- 4 Wait until the unstability symbol  disappears.  
⇒ When the balance is stable, the weighing value becomes dark blue.
- 5 Tap on [] to accept the weight and to start the procedure.
- 6 Place next sample weight.
- 7 Tap on [] to accept the second sample weight.  
⇒ The work title bar shows the number of samples (2 samples) and the total weight of the samples ( $\Sigma = 30.0000$  g).



### Discard value

If a weighing value was incorrect, it can be discarded from the result as follows:

- 1 Tap on [].  
⇒ The screen **Confirm discard** opens.
- 2 Tap on [].  
⇒ The incorrect value has been deleted. The weighing process can be continued.

### Display results

- 1 Tap on [].
- 2 Tap on [] **View result**.

### Note

The results can also be displayed by using the shortcut in the work title bar.

### Pause the application

- 1 Tap on [■].
- 2 Tap on [II] **Pause**.  
⇒ The application **Totaling** is paused and another application can be used in the meantime.
- 3 Open the application **Totaling** again.
- 4 Tap on [▶].  
⇒ The process can be continued.

### Terminate the application

- 1 Tap on [■].
- 2 Tap on [✓] **Finish**.  
⇒ The home screen of the application **Totaling** opens.

#### Note

If the option **Workflow reports** is set to **Automatic**, a printer symbol appears in the list element. By tapping on [✕] **Discard** the process can be aborted without printing the results.

### Totaling – Main configuration

The following options can be defined:

Parameter	Explanation	Values
<b>Accepting mode</b>	To define if a weight sample is added automatically to the result. The sample is automatically accepted if: the sample is at least 10d and a deflection according to the SNR command described in the <b>MT-SICS</b> manual [MT-SICS interface commands and functions ▶ 82] was detected.	<b>Manual*</b>   <b>Automatic</b>
<b>Main unit</b>	To define the main unit of the weighing process.	Available units are model and country-specific.
<b>Resolution</b>	To define the resolution of the weighing process.	Available resolutions are model-specific.

\* Factory setting

## 6.2 Activities - Adjustments and tests

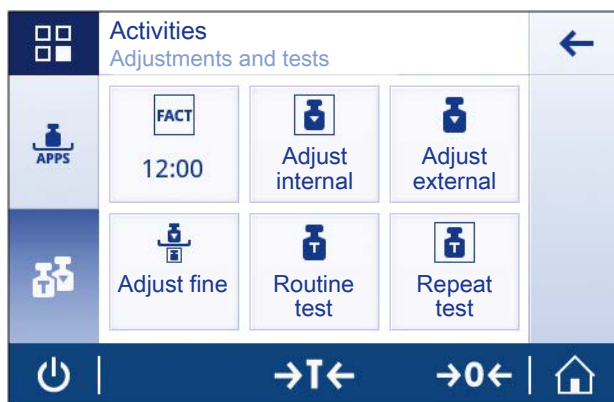

**Activities - Adjustments and tests** contains the following elements:

- **FACT**, see [FACT Fully automatic internal adjustment (for ME-T models only) ▶ 60]
- **Internal Adjustment**, see [Internal Adjustment ▶ 61] (for ME-T models only)
- **External Adjustment**, see [External Adjustment ▶ 62]
- **Fine adjustment**, see [Fine adjustment ▶ 63]
- **Routine test**, see [Routine test ▶ 64]
- **Repeatability test**, see [Repeatability test ▶ 65]

## 6.2.1 FACT Fully automatic internal adjustment (for ME-T models only)

**FACT** stands for **Fully Automatic Calibration Technology**. It is activated as default value.

**FACT** means that the balance adjusts itself based on the following criteria:



- in case the conditions change (temperature difference > 2°C), which could lead to a noticeable deviation in the measurement.
- on a predefined day time programmed by the user.

### Navigation

 **Activities** >  **Activities - Adjustments and tests** > **[FACT]**

### Setting FACT

You can define the day time of FACT as follows:

- 1 Tap on .
- 2 Tap on .
- ⇒ The screen **Activities - Adjustments and tests** opens.
- 3 Tap on **[FACT]**.
- 4 Activate **Fully automatic adjustment**.
- ⇒ The **Fully automatic adjustment** dialog opens.
- 5 Select the time (hours : minutes) with the pick buttons.
- 6 Tap on  to confirm the defined time.
- ⇒ The time underneath **FACT** has been updated and shows the time of the daily adjustment.

### CAUTION

If the function **FACT** is not activated, all the FACT functionalities, such as temperature FACT and time FACT are inactive.

### Note

When defining the time, hold the pick button to scroll faster.

## 6.2.2 Internal Adjustment

### Note

The function **Internal Adjustment** is available for models with internal weight only (see technical data).

### Navigation

 **Activities** >  **Adjustments and tests** >  **Adjust internal**

### Perform an internal adjustment manually

- 1 Tap on [**Adjust internal**].  
⇒ The internal adjustment procedure starts. The screen shows **Adjustment ongoing...**

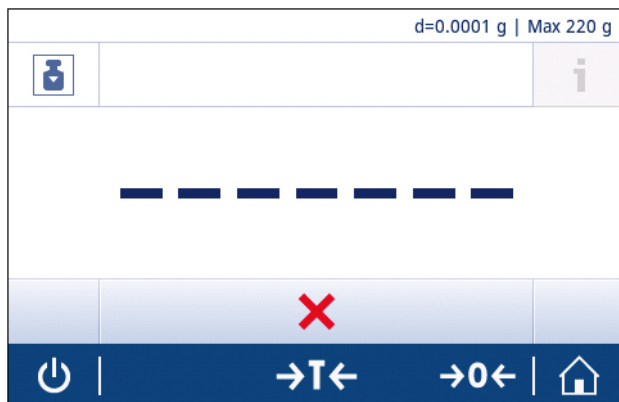

- ⇒ When the internal adjustment procedure is successfully completed, the results of the internal adjustment appear.
- 2 Tap on [✓] to confirm the results.

### Note

If the balance is configured and connected to a printer, the results of the adjustment process will be printed.

## 6.2.3 External Adjustment





### Note

Because of certification legislation, approved balances cannot be adjusted with an external weight (depending on the certification legislation of the selected country).

### Navigation

 **Activities** >  **Activities - Adjustments and tests** >  **Adjust external**

### Performing an external adjustment

- 1 Tap on  **Activities - Adjustments and tests**.
- 2 Tap on  **Adjust external**.  
⇒ The External Adjustment screen opens.
- 3 Tap on  to define the adjustment weight according to the weight certificate.
- 4 Confirm the adjustment weight by tapping on .
- 5 Prepare the adjustment weight and tap on  to start the adjustment process.
- 6 Load the adjustment weight in the center of the weighing pan.
- 7 Unload the adjustment weight from the weighing pan.  
⇒ When the external adjustment procedure is successfully completed, the result of the external adjustment appear.







## 6.2.4 Fine adjustment

With the function **Fine adjustment** the value of the internal adjustment weight can be individually adjusted in a very small range.

### Navigation

 >  **Activities - Adjustments and tests** >  **Adjust fine**

### Performing Fine adjustment

- Prepare the adjustment weight.
- 1 Tap on .
- ⇒ The dialog screen **Fine adjustment – Reference weight** opens.
- 2 Define the weight according to the certificate.
- 3 Tap on  to confirm.
- 4 Place the adjustment weight on the weighing pan.
- 5 Tap on  to start the procedure.
- 6 Follow the procedure steps.

### Note

Tap on  to reset the defined reference weight back to default value.

### Note

- This option is only available on models with internal weights.
- Approved models can not be adjusted with this function.
- Use only certificated weights.
- Make sure that the environment conditions are alright.
- The balance must be leveled.
- Balance and test weights must have operating temperature.
- For the fine adjustment we recommend to call a balance expert or an MT representative.

## 6.2.5 Routine test

The function **Routine test** allows to define the sensitivity of the balance for periodic tests.

### Navigation

[] **Activities** > [] **Activities - Adjustments and tests** > [] **Routine test**

### Note

More detailed information about the function **Routine test** can be found on:

- 1 Tap on [] **Routine test – Main configuration**.
- 2 Tap on [] **Test Weight**.
- 3 Define the option **Test weight in g**.
- 4 Tap on [] **± Control limit in g**
- 5 Define the option **± Control limit in g**.
- 6 Tap on [] **± Warning limit in g**
- 7 Define the option **± Warning limit in g**
- 8 Tap on [] to confirm the changes.
- 9 Activate or deactivate the option [**Use tare container**] if required.
- 10 Tap on [] to confirm.
  - ⇒ The defined values appear at the top of the screen in the weighing information bar. The bar does work as a shortcut.

### Performing a routine test

- The routine test options **Test weight in g**, **± Control limit in g** and **± Warning limit in g** are defined.
- 1 Prepare the test weight.
  - 2 Tap on [] to start the process.
  - 3 Load the test weight in the center of the weighing pan.
    - ⇒ During the test, the screen shows **Waiting for stable weight...**
    - ⇒ When the test is finished the screen shows **Please unload weight**.
  - 4 Unload the weighing pan.
    - ⇒ The screen shows the final routine test overview.

### Routine test – Main configuration

The following options can be defined:

Parameter	Explanation	Values
<b>Test weight in g</b>	Defines the test weight.	numerical value (depending on the balance type)
<b>± Control limit in g</b>	Defines the control limit.	numerical value (depending on the balance model)
<b>± Warning limit in g</b>	Defines the warning limit.	<b>ON</b> * numerical value (depending on the balance model)   <b>OFF</b>
<b>Use tare container</b>	To define whether a container is used or not.	<b>ON</b>   <b>OFF</b> *

\* Factory setting

## 6.2.6 Repeatability test

With the function **Repeatability test** a specific number of internal weight tests can be defined.

### Navigation

 **Activities** >  **Activities - Adjustments and tests** >  **Repeatability test**

### Note

The function **Repeatability test** works only for models with internal weights.

### Define the number of repetition

- 1 Tap on **Repeatability test - Main configuration** or use the shortcut.  
⇒ The dialog **Repetitions** appears.
- 2 Define the number of repetition. The number must be between 5 and 100.
- 3 Tap on [✓] to confirm the number of repetitions.
- 4 Tap on [▶] to start the process.  
⇒ The balance executes the defined number of tests. On the display appears **Test ongoing...** during the process. The process can be aborted by tapping on [✕].  
⇒ After the test has been finished, an overview with the test results appears on the screen.

## 7 General Settings

The section **Settings** is divided into two sub-sections:

- **Quick settings**
- **General configuration**

### 7.1 Quick settings

The following options are available:

- **Date and Time**
- **Brightness**
- **Sound**
- **Language**
- **Glove mode**
- **Quick Adjustment**
- **Date/Time widget**

#### 7.1.1 Date and time

In this menu topic, the date and time can be defined. Tap on [⌚] for **Time** and tap on [📅] for **Date**.

The following parameters can be defined:

Parameter	Explanation	Values
<b>Time</b>	To define the time format.	<b>24:MM*</b>   <b>12:MM</b>   <b>24.MM</b>   <b>12.MM</b>
	The date can be defined with the pick buttons.	<b>Hours</b>   <b>Minutes</b>
<b>Date</b>	To define the date format.	<b>DD.MM.YYYY*</b>   <b>D.MMM YYYY</b>   <b>MM/DD/YYYY</b>   <b>MMM DD YYYY</b>   <b>YYYY-MM-DD</b>
	The date can be defined with the pick buttons.	<b>Day</b>   <b>Month</b>   <b>Year</b>

\* Factory setting

#### 7.1.2 Brightness

In this menu topic the brightness of the display can be defined.

Parameter	Explanation	Values
<b>Brightness</b>	To define the level of brightness.	10...100 % (50 %*)

\* Factory setting

### 7.1.3 Sound

In this menu topic, the sound can be defined.

Parameter	Explanation	Values
<b>Stability beep</b>	Notifies when an unstable weight becomes stable.	<b>OFF</b>   <b>Low*</b>   <b>Medium</b>   <b>High</b>
<b>Workflow feedback beep</b>	Provides additional feedback in case of input errors, messages and status notifications..	<b>OFF</b>   <b>Low*</b>   <b>Medium</b>   <b>High</b>
<b>Touch beep</b>	Notifies every touch of interactive elements on touch display and zero/tare bar.	<b>OFF*</b>   <b>Low</b>   <b>Medium</b>   <b>High</b>

\* Factory setting

### 7.1.4 Language

The following languages can be chosen:

<b>English</b>	Русский	<b>Português BR</b>
<b>Deutsch</b>	<b>Polski</b>	<b>Türkçe</b>
<b>Français</b>	<b>Česky</b>	中文
<b>Español</b>	<b>Magyar</b>	日本語
<b>Italiano</b>	<b>Nederlands</b>	한국어

### 7.1.5 Glove mode

With the function **Glove mode** activated, the touch-screen becomes more sensitive and easier to navigate when wearing gloves.

Parameter	Explanation	Values
<b>Glove mode</b>	To activate or deactivate the function <b>Glove mode</b> .	<b>ON</b>   <b>OFF*</b>

\* Factory setting

### 7.1.6 Quick Adjustment

Parameter	Explanation	Values
<b>Quick Adjustment</b>	To activate/deactivate and define the function <b>Quick Adjustment</b> .	<b>Internal Adjustment</b> (model-specific)   <b>External Adjustment</b>

\* Factory setting

#### Note

If the option **Quick Adjustment** is activated, the symbol  appears in the main navigation of an application.

### 7.1.7 Date/Time widget

Parameter	Explanation	Values
<b>Date/Time widget</b>	With the option activated, the current date and time in the work area will permanently be displayed in the value bar above the weighing value field.	<b>ON</b>   <b>OFF*</b>

\* Factory setting

## 7.2 General configuration

The following options are available:

- **Weighing options**
- **Publishing**
- **Devices/connectivity**
- **System settings**
- **Access protection**
- **ISO-Log**

### 7.2.1 Weighing options

The following options can be defined:

Parameter	Explanation	Values
<b>Weighing mode</b>	To define <b>Weighing mode</b> .	<b>Universal*</b> = for standard weighing applications <b>Dosing</b> = for dosing liquids or powdery samples
<b>Environment</b>	To adapt the balance to the environmental circumstances.	<b>Stable</b> = for stable environments <b>Standard*</b> = for standard environments <b>Unstable</b> = for unstable environments <b>Very unstable</b> = for very unstable environments
<b>Autozero</b>	To activate or deactivate <b>Autozero</b>	<b>ON*</b>   <b>OFF</b>
<b>AutoTare</b>	To activate or deactivate <b>AutoTare</b>	<b>ON</b>   <b>OFF*</b>
<b>Auto clear tare</b>	With the function <b>Auto clear tare</b> activated, the current tare is automatically cleared after removing all loaded weight from the weighing pan. This function applies to all applications except for <b>Formulation</b> .	<b>ON</b>   <b>OFF*</b>
<b>Recall</b>	To retain and recall the last stable weight.	<b>ON</b>   <b>OFF*</b>

\* Factory setting

#### Note

The function **Autozero** can not be deactivated for approved balances (except for some selected countries).

## 7.2.2 Publishing

In this section, the print and output options can be defined.

### Note

Depending on the connected peripheral device (**see** [Devices and connectivity ▶ 71]) the available options in this section can differ. It is possible that not every options described in this section is available for the used peripheral device.

### Print

This option can be activated or deactivated.

The following options can be defined:

Parameter	Explanation	Values
<b>Printer</b>	Defines to which printer the data will be sent.	<b>Serial printer   USB printer   Print to file</b>
<b>Single values report</b>	Defines the behaviour of the printer for single values.	<b>Manual, stable*   Manual, all values   Automatic, stable   Automatic, stable (zero included)</b>
<b>Workflow reports</b>	Defines the workflow of the reports.	<b>Automatic*   Manual</b>
<b>FACT report</b>	Defines whether the FACT report is being printed automatically or must be printed manually after the adjustment.	<b>Automatic*   OFF</b>

\* Factory setting

## Send value

This option can be activated or deactivated.

The following options can be chosen:

Parameter	Explanation
<b>Manual, stable*</b>	<b>Send next stable weight at will</b>
<b>Manual, all values</b>	<b>Send any stable or unstable weight at will</b>
<b>Automatic, stable</b>	<b>Send next stable weight automatically</b>
<b>Automatic, continuous</b>	<b>Send any stable or unstable weight automatically</b>

\* Factory setting

## Advanced options

In this section, the following options can be defined:

Parameter	Explanation	Values
<b>Adjustments/ Tests – Reports configuration</b>	Defines <b>Header</b> and <b>Footer</b> for the adjustment and test reports.	<b>Header   Footer</b>
<b>Autopublish</b>	Defines the publishing time interval of single values.	<b>ON</b> numerical values (1...65535 seconds)   <b>OFF*</b>
<b>Commands options</b>	Activates the function <b>Print and tare</b> . The balance will tare automatically after publishing.	<b>ON   OFF*</b>

\* Factory setting



### 7.2.3 Devices and connectivity

This section describes how the peripheral devices can be configured.

#### RS232

The following options can be defined:

Parameter	Values
Allocated device	RS-P2X*   P5X   Printer   Host   PC-Direct   Second display   Barcode Reader
Command set	MT-SICS*   MT-PM   Sartorius 22   Sartorius 16
Baudrate	600   1200   2400   4800   9600*   19200   38400   57600   115200 (available values are device-specific)
Bit/Parity	8/No*   7/No   7/Mark   7/Space   7/Even   7/Odd
Stop bits	1 bit*   2 bits
Handshake	Xon/Xoff*   RTS/CTS   None
Character set	IBM/DOS*   ANSI/WIN   UTF-8 (UTF-8 is device-specific)
End of line	<CR><LF>*   <CR>   <LF>   <TAB>

\* Factory setting

#### USB Device

The following options can be defined:

Parameter	Values
Allocated device	Host*   PC-Direct
Command set	MT-SICS*   MT-PM   Sartorius 22   Sartorius 16
Character set	IBM/DOS*   ANSI/WIN   UTF-8 (UTF-8 is device-specific)
End of line	<CR><LF>*   <CR>   <LF>   <TAB>

\* Factory setting

#### USB Host

The following options can be defined:

Parameter	Values
Allocated device	Host*   PC-Direct
Command set	MT-SICS*   MT-PM   Sartorius 22   Sartorius 16
Character set	IBM/DOS*   ANSI/WIN   UTF-8 (UTF-8 is device-specific)
End of line	<CR><LF>*   <CR>   <LF>   <TAB>

\* Factory setting

## 7.2.4 System settings

The following options can be defined:

Parameter	Explanation	Values
<b>Balance identification</b>	A balance identification that can be defined by the user.	Values can be defined individually.
<b>Sleep mode</b>	Defines after how much time a screen saver with date and time appears.  Tap on the screen to exit the screen saver.	<b>After 30 seconds</b> <b>After 1 minute</b> <b>After 2 minutes</b> <b>After 5 minutes</b> <b>After 10 minutes*</b>
<b>Backlight OFF</b>	Defines after how much time the display turns off.  Tap on the screen to finish the mode <b>Backlight OFF</b> .	<b>After 30 seconds</b> <b>After 1 minute</b> <b>After 2 minutes</b> <b>After 5 minutes</b> <b>After 10 minutes</b>
<b>Quick wake up</b>	To exit <b>Sleep mode</b> and/or <b>Backlight OFF</b> by changing the weight on the weighing pan.	<b>ON*</b>   <b>OFF</b>
<b>Out of level notification</b>	To activate/deactivate the function <b>Out of level notification</b> .	<b>ON*</b>   <b>OFF</b>
<b>Service due notification</b>	To activate/deactivate the function <b>Service due notification</b> .	<b>ON*</b>   <b>OFF</b>

\* Factory setting

### Note

If the options **Sleep mode** and **Backlight OFF** have the same value, the screen safer appears for a short moment before the backlight goes off.

### System and data management

The following options can be defined:

Parameter	Explanation
<b>Touch screen adjustment...</b>	The balance is executing a screen adjustment.
<b>Level center adjustment</b>	The adjustment sets the exact center position of the level indicator and corrects any possible shifts.
<b>Reset balance...</b>	To reset the balance to factory settings.
<b>Backup and restore...</b>	Generates a backup of the current balance settings. <b>Note</b> To execute a backup an external storage device must be connectes to the USB host port A

### CAUTION

By resetting the balance, any changes to general settings and contextual settings that have been made as well as any temporary collected data (e.g. paused applications or statistics) will be lost.

## 7.2.5 Access protection

With the function **Access protection**, certain functionalities of the balance can be protected by a numerical passcode.

The following options can be defined:

Parameter	Explanation	Values
<b>Applications</b>	To protect the application.	<b>ON   OFF*</b>
<b>Adjustments and tests</b>	To protect adjustments and tests.	<b>ON   OFF*</b>
<b>Settings</b>	To protect all settings.	<b>ON   OFF*</b>
<b>Passcode</b>	To define the passcode by the user.	1 ....9 (1-12 digits)

\* Factory setting

### User passcode

The user passcode can be defined by the user. The default value is 12345678. The length of the freely changeable user passcode is restricted to 12 digits.

#### Note

Passcode and access options are not affected by a balance reset.

### What if you forget the passcode?

When you forget or lose the passcode, please contact a Mettler Toledo representative or visit the Mettler Toledo balance support site.

## 7.2.6 ISO-log

In this section, detailed history information about adjustments performed, intensity of use and settings can be displayed.

The following options can be selected:

Parameter	Explanation
<b>ISO-Log – Adjustments</b>	Shows detailed information about the performed adjustments.
<b>ISO-Log – Balance</b>	Shows detailed information about the balance history.
<b>ISO-Log – Settings and status</b>	Shows detailed information about changes which have been made to the settings.

## 8 Communication with Peripheral Devices

### 8.1 PC-Direct Function

The numerical value displayed on the balance can be transferred to the cursor position in Windows Applications (e.g. Excel, Word), by typing with the keyboard.

**Note:** The units will not be transferred.

#### Requirements

- PC with one of the following Microsoft Windows® operating systems 32bit/64bit: XP (SP3), Vista (SP2), Win 7 (SP1) or Win 8
- Serial interface RS232, USB or BT option
- Administrator rights for installing software (for USB not required)
- Windows Application (e.g. Excel)
- Balance to PC connection with RS232 or USB cable

#### Settings on the balance:

##### CAUTION

Disconnect the USB connection from the balance prior to changing settings.

#### Balance Interface Settings (see Interface Menu):

- Topic **RS232** or **USB Device**: set **PC-Direct** and select the most appropriate option for the desired weighing result.
- Topic **End of line** (transmitted end of line character):
  - set **<TAB>** to write into the same row (e.g. in Excel).
  - set **<CR><LF>** to write into the same column (e.g. in Excel).
- Save changes.

#### Download SerialPortToKeyboard\_1-10.exe

Operation of PC-Direct via serial port RS232 requires the installation of the file **SerialPort-ToKeyboard\_1-10.exe** on your host computer.

The file **SerialPortToKeyboard\_1-10.exe** can be found on the CD-ROM in the folder "Software <SerialPort-ToKeyboard> (en)" or it can be downloaded from [www.mt.com](http://www.mt.com). If you have any questions please contact a METTLER TOLEDO representative.

#### Installation

- 1 Open the file **SerialPortToKeyboard\_1-10.exe**.
  - ⇒ The installation procedure starts.
- 2 Follow the steps of the installation.
  - ⇒ The installation starts.

### Settings for SerialPortToKeyboard

- 1 Select the serial port (COM) to be used for connection with the balance.
- 2 Set the baud rate to 9600.
- 3 Activate "Connect"

#### Note

- The window can be minimized.
- Closing the window terminates the session.

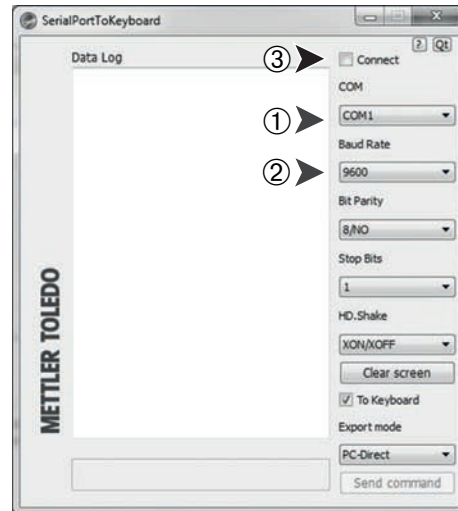

### Checking operation

- 1 Start **SerialPortToKeyboard** (RS232)
- 2 Start Excel (or another application) on the PC.
- 3 Activate a cell in Excel.

According to your selected **PC-Direct** option, the displayed values will appear e.g. in the column one after the other one in the different rows.

## 8.2 USB Device Interface

To perform the functionality **USB DEVICE** with a PC equipped only with a USB Interface, you have to install an appropriate USB driver on the PC first.

### Requirements

- Balance with USB device Interface.
- PC with one of the Microsoft Windows® operating systems 32bit/64bit: XP (SP3), Vista (SP2), Win 7 (SP1) or Win 8.
- Administrator rights for installing software.
- PC to balance USB connection cable.

### Download USB driver

The file **USBDriverInstaller.exe** can be found on the CD-ROM in the folder "Software <USB Driver> (en)" or it can be downloaded from [www.mt.com](http://www.mt.com). If you have any questions please contact a METTLER TOLEDO representative.

### Installation

- 1 Click **Save** to download to your specified location.
- 2 Right-click on the downloaded install program: **USBDriverInstaller.exe** and select Run as Administrator from the menu.
- 3 If a safety warning appears, allow Windows to install.

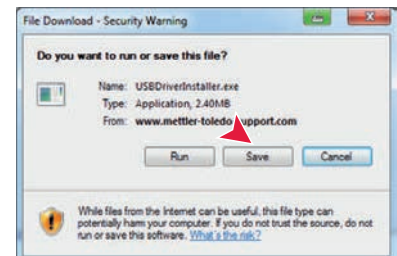

- 4 Click **Next** and follow the installer's instructions.

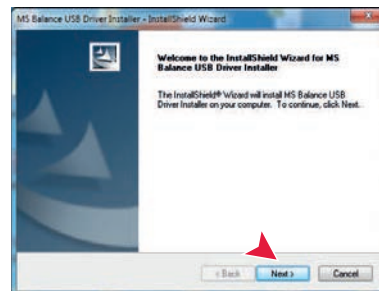

### Installing instrument

- 1 Switch the balance **off**.
- 2 Connect the balance to the preferred USB Port on the PC.
- 3 Switch the balance **on**.
- 4 Follow the instructions of the Wizard and install the software automatically (recommended)



**Note:** The wizard appears again for each USB port, either on your PC or if another balance is connected.

**Warning:** Do not click **Cancel** as for the connected USB port, it might not be possible to perform the installation process anymore.



## 9 Error and Status Messages

Error messages in the display draw your attention to incorrect operation or that the balance could not execute a procedure properly.

Error message	Cause	Rectification
<b>NO STABILITY</b>	No stability	Ensure more stable ambient conditions. If not possible, check settings for environment.
<b>Adjustment aborted - Weight out of range</b>	Wrong adjustment weight on the weighing pan or none at all.	Place required adjustment weight in center of pan.
<b>EEPROM error - Please contact your MT-Support representative.</b>	<ul style="list-style-type: none"> <li>EEPROM (memory) error.</li> <li>Excessive mains voltage fluctuation or strong glitches occurred.</li> </ul>	<b>Please contact your MT-Support representative.</b>
<b>Wrong cell data - Please contact your MT-Support representative.</b>	Wrong cell data.	<b>Please contact your MT-Support representative.</b>
<b>No standard adjustment - Please contact your MT-Support representative.</b>	No standard calibration.	<b>Please contact your MT-Support representative.</b>
<b>Program memory defect - Please contact your MT-Support representative.</b>	Program memory defect.	<b>Please contact your MT-Support representative.</b>
<b>Temperature sensor defect - Please contact your MT-Support representative.</b>	Temperature sensor defect.	<b>Please contact your MT-Support representative.</b>
<b>Wrong load cell brand - Please contact your MT-Support representative.</b>	Wrong load cell brand.	<b>Please contact your MT-Support representative.</b>
<b>Wrong type data set - Please contact your MT-Support representative.</b>	Wrong type data set.	<b>Please contact your MT-Support representative.</b>
<b>Battery backup lost - Please check date and time settings.</b>	Backup battery is empty. This battery ensures that the date and time are not lost when the balance is disconnected from power.	Connect the balance to the power supply for charging the battery (e.g. during the night) or contact METTLER TOLEDO customer service.
	Overload - The weight on the pan exceeds the weighing capacity of the balance.	Reduce the weight on the weighing pan.
	Underload	Check that the weighing pan is positioned correctly.
<b>Weight is above initial zero range.</b>	Wrong weighing pan or pan is not empty.	Mount correct weighing pan or unload weighing pan.
<b>Weight is below initial zero range.</b>	Wrong weighing pan or pan is missing.	Mount correct weighing pan.
<b>Memory full</b>	Memory full.	Clear the memory and start a new evaluation.
<b>Weight out of range</b>	Sample weight is outside the allowed range.	Unload the pan and load a new sample weight.

## 10 Maintenance



### **WARNING**

#### **Risk of electric shock**

- The instrument must be disconnected from the power supply, before cleaning or other maintenance work to be performed.
- Use only the power cord from METTLER TOLEDO, if it needs replacing.

#### **Please observe the following notes:**

##### **Note**

On no account use cleaning agents which contain solvents or abrasive ingredients, as this can result in damage to the touch screen.

### 10.1 Cleaning and Service

Every now and then, clean the weighing pan, draft shield element, bottom plate, draft shield (depending on the model) and housing of your balance. Your balance is made from high-quality, durable materials and can therefore be cleaned using a damp cloth or with a standard, mild cleaning agent.

#### **Please observe the following notes:**



- The balance must be disconnected from the power supply
- Ensure that no liquid comes into contact with the balance or the AC adapter.
- Never open the balance or AC adapter – they contain no components, which can be cleaned, repaired or replaced by the user.



- On no account use cleaning agents which contain solvents or abrasive ingredients, as this can result in damage to the operation panel overlay.
- Do not use wet, but only damp cloth for cleaning.



Please contact your METTLER TOLEDO dealer for details of the available service options. Regular servicing by an authorized service engineer ensures constant accuracy for years to come and prolongs the service life of your balance.

### 10.2 Draft Shield

#### **Removing or inserting sliding glass doors**

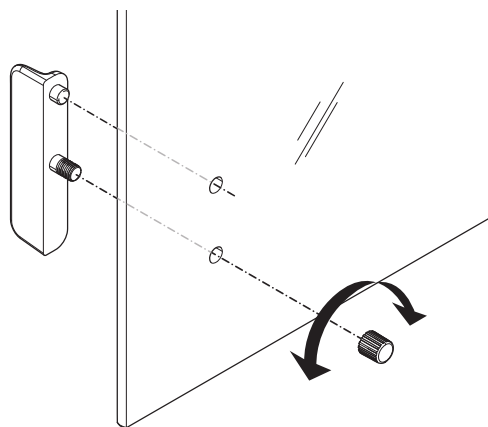

It is possible to remove the sliding glass doors for cleaning or for replacing. In this case you have to remove the handle first. Installing the handle after insertion of the glass door.

##### **Note**

Front and rear glass panels cannot be removed.



### 10.3 Disposal

In conformance with the European Directive 2002/96/EC on Waste Electrical and Electronic Equipment (WEEE) this device may not be disposed of in domestic waste. This also applies to countries outside the EU, per their specific requirements.

Please dispose of this product in accordance with local regulations at the collecting point specified for electrical and electronic equipment. If you have any questions, please contact the responsible authority or the distributor from which you purchased this device. Should this device be passed on to other parties (for private or professional use), the content of this regulation must also be related.

Thank you for your contribution to environmental protection.



## 11 Interface Specification

### 11.1 RS232 interface

Each balance is equipped with an RS232 Interface as standard for the attachment of a peripheral device (e.g. printer or computer).

Schematic	Item	Specification
	Interface type	Voltage interface according to EIA RS-232C/ DIN66020 CCITT V24/V.28)
	Max. cable length	15 m
	Signal level	Outputs: +5 V ... +15 V (RL = 3–7 kΩ) –5 V ... –15 V (RL = 3–7 kΩ) Inputs: +3 V ... +25 V –3 V ... –25 V
	Connector	Sub-D, 9-pole, female
	Operating mode	Full duplex
	Transmission mode	Bit-serial, asynchronous
	Transmission code	ASCII
	Baud rates	600, 1200, 2400, 4800, 9600, 19200, 38400, 57600, 115200 (software selectable)
	Bits/parity	7-bit/none, 7-bit/even, 7-bit/odd, 8-bit/none (software selectable)
	Stop bits	1 stop bit
	Handshake	None, XON/XOFF, RTS/CTS (software selectable)
	End-of-line	<CR><LF>, <CR>, <LF> (software selectable)
	Power supply for 2nd display	+ 12 V, max 40 mA (software selectable, 2nd display mode only)

## 11.2 USB host

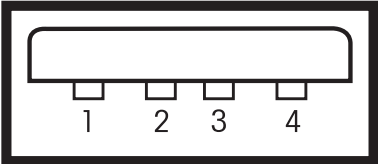
Schematic	Item	Specification	
	Standard	In conformity with USB Specification Revision 1.0/1.1	
	Speed	Full speed 12 Mbps (requires shielded cable)	
	Power usage	Max. 500 mA	
	Connector	Type A	
	Pin assignment	1	VBUS (+5 V DC)
		2	D- (Data -)
		3	D+ (Data +)
4		GND (Ground)	
Shell	Shield		

## 11.3 USB device

Each balance is equipped with an USB device interface as standard for the attachment of a peripheral device (e.g. computer).

### Note

This interface is not suitable to communicate with a printer.

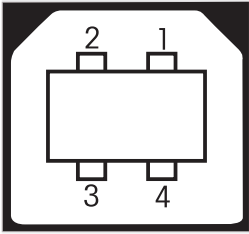
Schematic	Item	Specification										
 <table border="1" data-bbox="422 1176 707 1340"> <tbody> <tr> <td>1</td> <td>VBUS (+5 VDC)</td> </tr> <tr> <td>2</td> <td>D- (Data -)</td> </tr> <tr> <td>3</td> <td>D+ (Data +)</td> </tr> <tr> <td>4</td> <td>GND (Ground)</td> </tr> <tr> <td>Shield</td> <td>Shield</td> </tr> </tbody> </table>	1	VBUS (+5 VDC)	2	D- (Data -)	3	D+ (Data +)	4	GND (Ground)	Shield	Shield	Standard	In conformity with USB Specification Revision 1.1
	1	VBUS (+5 VDC)										
	2	D- (Data -)										
	3	D+ (Data +)										
	4	GND (Ground)										
	Shield	Shield										
Speed	Full speed 12 Mbps (requires shielded cable)											
Function	CDC (Communication Device Class) serial port emulation											
Power usage	Suspended device: Max 10 mA											
Connector	Type B											

## 11.4 MT-SICS interface commands and functions

Many of the instruments and balances used have to be capable of integration in a complex computer or data acquisition system.

To enable you to integrate balances in your system in a simple manner and utilize their capabilities to the full, most balance functions are also available as appropriate commands via the data interface.

All new METTLER TOLEDO balances launched on the market support the standardized command set "METTLER TOLEDO Standard Interface Command Set" (MT-SICS). The commands available depend on the functionality of the balance.

For further information please contact your METTLER TOLEDO representative.

## 12 Technical Data

### 12.1 General Data

#### Standard power supply

AC adapter primary: 100 – 240 V,  $\pm 10\%$ , 50/60Hz, 0.3 A  
Secondary: 12 V DC, 0.84 A (with electronic overload protection)  
Balance power supply: 12 V DC, 0.84 A



Use only with a tested AC Adapter with SELV output current.  
Ensure correct polarity  $\ominus$    $\oplus$

Can be used up to 2000 m height above mean sea level.

#### Note

If the balance is used above 2000 m mean sea level, the optional power supply must be used.

#### Optional power supply

AC adapter primary: 100 - 240 V AC,  $-15\%/+10\%$ , 50/60 Hz  
Secondary: 12 V DC  $\pm 3\%$ , 2.5 A (with electronic overload protection)  
Cable for AC adapter: 3-core, with country-specific cable.  
Balance power supply: 12 V DC  $\pm 3\%$ , 2.25 A, maximum ripple: 80 mVpp  
Can be used up to 4000 m height above mean sea level.

#### Protection and Standards

- Overvoltage categorie: II
- Degree of pollution: 2
- Degree of protection: Protected against dust and water.
- Standards for safety and EMC: See Declaration of Conformity
- Range of application: For use only in dry interior rooms

#### Environmental conditions

- Height above mean sea level: Depending on the power adapter (2000 - 4000 m)  
Except for China: max. 2000 m
- Ambient temperature range: Operating condition for ordinary lab application:  $+10$  to  $30$  °C  
(operability guaranteed between  $+5$  to  $40$  °C)  
Storage condition:  $-25$  to  $70$  °C
- Relative air humidity: 10% up to 80 % at  $31$  °C, linearly decreasing to 50 % at  $40$  °C, noncondensing

#### Materials

- Housing: Top housing: Plastic (ABS)  
Bottom housing: Die-cast aluminum, lacquered
- Weighing pan: Pan  $\varnothing$  90 mm: Stainless steel X2CrNiMo 17-12-2 (1.4404)  
All others: Stainless steel X5CrNi 18-10 (1.4301)
- Draft shield element: 0.1 mg models: Stainless steel X5CrNi 18-10 (1.4301)
- Draft shield: Plastic (ABS), glass
- In-use-cover: Plastic (PET)
- TFT touch screen surface: Glass

## 12.2 Model-Specific Data

### 12.2.1 Balances with readability of 0.1 mg with draft shield

#### Technical Data

	ME54T	ME54TE
<b>Limit values</b>		
Maximum capacity	52 g	52 g
Readability	0.1 mg	0.1 mg
Repeatability (at nominal load)	0.1 mg	0.1 mg
Linearity deviation	0.2 mg	0.2 mg
Sensitivity temperature drift	2 ppm/°C	2 ppm/°C
<b>Typical values</b>		
Repeatability (at nominal load)	0.08 mg	0.08 mg
Linearity deviation	0.06 mg	0.06 mg
Minimum sample weight (acc. to USP)	0.16 g	0.16 g
Minimum sample weight (U=1 %, k=2)	16 mg	16 mg
Minimum sample weight OIML	10 mg	10 mg
Settling time	2 s	2 s
Adjustment	Int. Cal / FACT	Ext. Cal
Interface	1 x RS232 / 2 x USB	1 x RS232 / 2 x USB
Balance dimensions (w x d x h)	210 x 344 x 344 mm	210 x 344 x 344 mm
Weighing pan dimensions	∅ 90 mm	∅ 90 mm
Usable height of draft shield	238 mm	238 mm
Weight of balance	5.6 kg	5.3 kg
<b>Weights for routine testing</b>		
OIML CarePac	#11123003	#11123003
Weights	50 g F2, 2 g E2	50 g F2, 2 g E2
ASTM CarePac	#11123103	#11123103
Weights	50 g 1, 2 g 1	50 g 1, 2 g 1

	ME104T	ME104TE
<b>Limit values</b>		
Maximum capacity	120 g	120 g
Readability	0.1 mg	0.1 mg
Repeatability (at nominal load)	0.1 mg	0.1 mg
Linearity deviation	0.2 mg	0.2 mg
Sensitivity temperature drift	2 ppm/°C	2 ppm/°C
<b>Typical values</b>		
Repeatability (at nominal load)	0.08 mg	0.08 mg
Linearity deviation	0.06 mg	0.06 mg
Minimum sample weight (acc. to USP)	0.16 g	0.16 g
Minimum sample weight (U=1 %, k=2)	16 mg	16 mg
Minimum sample weight OIML	10 mg	10 mg
Settling time	2 s	2 s
Adjustment	Int. Cal / FACT	Ext. Cal
Interfaces	1 x RS232 / 2 x USB	1 RS232 / 2 x USB
Balance dimensions (w x d x h)	210 x 344 x 344 mm	210 x 344 x 344 mm
Weighing pan dimensions	ø 90 mm	ø 90 mm
Usable height of draft shield	238 mm	238 mm
Weight of balance	5.6 kg	5.3 kg
<b>Weights for routine testing</b>		
OIML CarePac	#11123002	#11123002
Weights	100 g F2, 5 g E2	100 g F2, 5 g E2
ASTM CarePac	#11123102	#11123102
Weights	100 g 1, 5 g 1	100 g 1, 5 g 1

	ME204T	ME204TE
<b>Limit values</b>		
Maximum capacity	220 g	220 g
Readability	0.1 mg	0.1 mg
Repeatability (at nominal load)	0.1 mg	0.1 mg
Linearity deviation	0.2 mg	0.2 mg
Sensitivity temperature drift	2 ppm/°C	2 ppm/°C
<b>Typical values</b>		
Repeatability (at nominal load)	0.08 mg	0.08 mg
Linearity deviation	0.06 mg	0.06 mg
Minimum sample weight (acc. to USP)	0.16 g	0.16 g
Minimum sample weight (U=1 %, k=2)	16 mg	16 mg
Minimum sample weight OIML	10 mg	10 mg
Settling time	2 s	2 s
Adjustment	Int. Cal / FACT	Ext. Cal
Interfaces	1 x RS232 / 2 x USB	1 x RS232 / 2 x USB
Balance dimensions (w x d x h)	210 x 344 x 344 mm	210 x 344 x 344 mm
Weighing pan dimensions	ø 90 mm	ø 90 mm
Usable height of draft shield	238 mm	238 mm
Weight of balance	5.6 kg	5.3 kg
<b>Weights for routine testing</b>		
OIML CarePac	#11123001	#11123001
Weights	200 g F2, 10 g F1	200 g F2, 10 g F1
ASTM CarePac	#11123101	#11123101
Weights	200 g 1, 10 g 1	200 g 1, 10 g 1



## 12.2.2 Balances with readability of 1 mg with draft shield

### Technical Data

	ME103T	ME103TE
<b>Limit values</b>		
Maximum capacity	120 g	120 g
Readability	1 mg	1 mg
Repeatability (at nominal load)	1 mg	1 mg
Linearity deviation	2 mg	2 mg
Sensitivity temperature drift	3 ppm/°C	3 ppm/°C
<b>Typical values</b>		
Repeatability (at nominal load)	0.7 mg	0.7 mg
Linearity deviation	0.6 mg	0.6 mg
Minimum sample weight (acc. to USP)	1.4 g	1.4 g
Minimum sample weight (U=1 %, k=2)	0.14 g	0.14 g
Minimum sample weight OIML	20 mg	20 mg
Settling time	1.5 s	1.5 s
Adjustment	Int. Cal / FACT	Ext. Cal
Interface	1 x RS232 / 2 x USB	1 x RS232 / 2 x USB
Balance dimensions (w x d x h)	210 x 319 x 289 mm	210 x 319 x 289 mm
Weighing pan dimensions	∅ 120 mm	∅ 120 mm
Usable height of draft shield	172.6 mm	172.6 mm
Weight of balance	4.5 kg	3.8 kg
<b>Weights for routine testing</b>		
OIML CarePac	#11123002	#11123002
Weights	100 g F2, 5 g E2	100 g F2, 5 g E2
ASTM CarePac	#11123102	#11123102
Weights	100 g 1, 5 g 1	100 g 1, 5 g 1

	ME203T	ME203TE
<b>Limit values</b>		
Maximum capacity	220 g	220 g
Readability	1 mg	1 mg
Repeatability (at nominal load)	1 mg	1 mg
Linearity deviation	2 mg	2 mg
Sensitivity temperature drift	3 ppm/°C	3 ppm/°C
<b>Typical values</b>		
Repeatability (at nominal load)	0.7 mg	0.7 mg
Linearity deviation	0.6 mg	0.6 mg
Minimum sample weight (acc. to USP)	1.4 g	1.4 g
Minimum sample weight (U=1 %, k=2)	0.14 g	0.14 g
Minimum sample weight OIML	20 mg	20 mg
Settling time	1.5 s	1.5 s
Adjustment	Int. Cal / FACT	Ext. Cal
Interface	1 x RS232 / 2 x USB	1 x RS232 / 2 x USB
Balance dimensions (w x d x h)	210 x 319 x 289 mm	210 x 319 x 289 mm
Weighing pan dimensions	∅ 120 mm	∅ 120 mm
Usable height of draft shield	172.6 mm	172.6 mm
Weight of balance	4.5 kg	3.8 kg
<b>Weights for routine testing</b>		
OIML CarePac	#11123001	#11123001
Weights	200 g F2, 10 g F1	200 g F2, 10 g F1
ASTM CarePac	#11123101	#11123101
Weights	200 g 1, 10 g 1	200 g 1, 10 g 1

	ME303T	ME303TE
<b>Limit values</b>		
Maximum capacity	320 g	320 g
Readability	1 mg	1 mg
Repeatability (at nominal load)	1 mg	1 mg
Linearity deviation	2 mg	2 mg
Sensitivity temperature drift	3 ppm/°C	3 ppm/°C
<b>Typical values</b>		
Repeatability (at nominal load)	0.7 mg	0.7 mg
Linearity deviation	0.6 mg	0.6 mg
Minimum sample weight (acc. to USP)	1.4 g	1.4 g
Minimum sample weight (U=1 %, k=2)	0.14 g	0.14 g
Minimum sample weight OIML	20 mg	20 mg
Settling time	1.5 s	1.5 s
Adjustment	Int. Cal / FACT	Ext. Cal
Interface	1 x RS232 / 2 x USB	1 x RS232 / 2 x USB
Balance dimensions (w x d x h)	210 x 319 x 289 mm	210 x 319 x 289 mm
Weighing pan dimensions	ø 120 mm	ø 120 mm
Usable height of draft shield	172.6 mm	172.6 mm
Weight of balance	4.5 kg	3.8 kg
<b>Weights for routine testing</b>		
OIML CarePac	#11123001	#11123001
Weights	200 g F2, 10 g F1	200 g F2, 10 g F1
ASTM CarePac	#11123101	#11123101
Weights	200 g 1, 10 g 1	200 g 1, 10 g 1

	ME403T	ME403TE
<b>Limit values</b>		
Maximum capacity	420 g	420 g
Readability	1 mg	1 mg
Repeatability (at nominal load)	1 mg	1 mg
Linearity deviation	2 mg	2 mg
Sensitivity temperature drift	3 ppm/°C	3 ppm/°C
<b>Typical values</b>		
Repeatability (at nominal load)	0.7 mg	0.7 mg
Linearity deviation	0.6 mg	0.6 mg
Minimum sample weight (acc. to USP)	1.4 g	1.4 g
Minimum sample weight (U=1 %, k=2)	0.14 g	0.14 g
Minimum sample weight OIML	20 mg	20 mg
Settling time	1.5 s	1.5 s
Adjustment	Int. Cal / FACT	Ext. Cal
Interface	1 x RS232 / 2 x USB	1 x RS232 / 2 x USB
Balance dimensions (w x d x h)	210 x 319 x 289 mm	210 x 319 x 289 mm
Weighing pan dimensions	∅ 120 mm	∅ 120 mm
Usable height of draft shield	172.6 mm	172.6 mm
Weight of balance	4.5 kg	3.8 kg
<b>Weights for routine testing</b>		
OIML CarePac	#11123000	#11123000
Weights	200 g F2, 20 g F1	200 g F2, 20 g F1
ASTM CarePac	#11123100	#11123100
Weights	200 g 1, 20 g 1	200 g 1, 20 g 1

	ME503T	ME503TE
<b>Limit values</b>		
Maximum capacity	520 g	520 g
Readability	1 mg	1 mg
Repeatability (at nominal load)	1 mg	1 mg
Linearity deviation	2 mg	2 mg
Sensitivity temperature drift	3 ppm/°C	3 ppm/°C
<b>Typical values</b>		
Repeatability (at nominal load)	0.7 mg	0.7 mg
Linearity deviation	0.6 mg	0.6 mg
Minimum sample weight (acc. to USP)	1.4 g	1.4 g
Minimum sample weight (U=1 %, k=2)	0.14 g	0.14 g
Minimum sample weight OIML	20 mg	20 mg
Settling time	1.5 s	1.5 s
Adjustment	Int. Cal / FACT	Ext. Cal
Interface	1 x RS232 / 2 x USB	1 x RS232 / 2 x USB
Balance dimensions (w x d x h)	210 x 319 x 289 mm	210 x 319 x 289 mm
Weighing pan dimensions	ø 120 mm	ø 120 mm
Usable height of draft shield	172.6 mm	172.6 mm
Weight of balance	4.5 kg	3.8 kg
<b>Weights for routine testing</b>		
OIML CarePac	#11123007	#11123007
Weights	500 g F2, 20 g F1	500 g F2, 20 g F1
ASTM CarePac	#11123107	#11123107
Weights	500 g 1, 20 g 1	500 g 1, 20 g 1

### 12.2.3 Balances with readability of 10 mg / 0.1 g

#### Technical Data

	ME1002T	ME1002TE
<b>Limit values</b>		
Maximum capacity	1200 g	1200 g
Readability	10 mg	10 mg
Repeatability (at nominal load)	10 mg	10 mg
Linearity deviation	20 mg	20 mg
Sensitivity temperature drift	3 ppm/°C	3 ppm/°C
<b>Typical values</b>		
Repeatability (at nominal load)	7 mg	7 mg
Linearity deviation	6 mg	6 mg
Minimum sample weight (acc. to USP)	14 g	14 g
Minimum sample weight (U=1 %, k=2)	1.4 g	1.4 g
Minimum sample weight OIML	0.5 g	0.5 g
Settling time	1.5 s	1.5 s
Adjustment	Int. Cal / FACT	Ext. Cal
Interfaces	1 x RS232 / 2 x USB	1 x RS232 / 2 x USB
Balance dimensions (w x d x h)	200 x 319 x 100 mm	200 x 319 x 100 mm
Weighing pan dimensions	180 x 180 mm	180 x 180 mm
Weight of balance	3.7 kg	3 kg
<b>Weights for routine testing</b>		
OIML CarePac	#11123008	#11123008
Weights	1000 g F2, 50 g F2	1000 g F2, 50 g F2
ASTM CarePac	#11123108	#11123108
Weights	1000 g 1, 50 g 1	1000 g 1, 50 g 1

	ME2002T	ME2002TE
<b>Limit values</b>		
Maximum capacity	2200 g	2200 g
Readability	10 mg	10 mg
Repeatability (at nominal load)	10 mg	10 mg
Linearity deviation	20 mg	20 mg
Sensitivity temperature drift	3 ppm/°C	3 ppm/°C
<b>Typical values</b>		
Repeatability (at nominal load)	7 mg	7 mg
Linearity deviation	6 mg	6 mg
Minimum sample weight (acc. to USP)	14 g	14 g
Minimum sample weight (U=1 %, k=2)	1.4 g	1.4 g
Minimum sample weight OIML	0.5 g	0.5 g
Settling time	1.5 s	1.5 s
Adjustment	Int. Cal / FACT	Ext. Cal
Interfaces	1 x RS232 / 2 x USB	1 x RS232 / 2 x USB
Balance dimensions (w x d x h)	200 x 319 x 100 mm	200 x 319 x 100 mm
Weighing pan dimensions	180 x 180 mm	180 x 180 mm
Weight of balance	3.7 kg	3 kg
<b>Weights for routine testing</b>		
OIML CarePac	#11123009	#11123009
Weights	2000 g F2, 100 g F2	2000 g F2, 100 g F2
ASTM CarePac	#11123109	#11123109
Weights	2000 g 1, 100 g 1	2000 g 1, 100 g 1

	ME3002T	ME3002TE
<b>Limit values</b>		
Maximum capacity	3200 g	3200 g
Readability	10 mg	10 mg
Repeatability (at nominal load)	10 mg	10 mg
Linearity deviation	20 mg	20 mg
Sensitivity temperature drift	3 ppm/°C	3 ppm/°C
<b>Typical values</b>		
Repeatability (at nominal load)	7 mg	7 mg
Linearity deviation	6 mg	6 mg
Minimum sample weight (acc. to USP)	14 g	14 g
Minimum sample weight (U=1 %, k=2)	1.4 g	1.4 g
Minimum sample weight OIML	0.5 g	0.5 g
Settling time	1.5 s	1.5 s
Adjustment	Int. Cal / FACT	Ext. Cal
Interface	1 x RS232 / 2 x USB	1 x RS232 / 2 x USB
Balance dimensions (w x d x h)	200 x 319 x 100 mm	200 x 319 x 100 mm
Weighing pan dimensions	180 x 180 mm	180 x 180 mm
Weight of balance	3.7 kg	3 kg
<b>Weights for routine testing</b>		
OIML CarePac	#11123009	#11123009
Weights	2000 g F2, 100 g F2	2000 g F2, 100 g F2
ASTM CarePac	#11123109	#11123109
Weights	2000 g 1, 100 g 1	2000 g 1, 100 g 1



	ME4001T	ME4001TE
<b>Limit values</b>		
Maximum capacity	4200 g	4200 g
Readability	0.1 g	0.1 g
Repeatability (at nominal load)	0.1 g	0.1 g
Linearity deviation	0.2 g	0.2 g
Sensitivity temperature drift	5 ppm/°C	5 ppm/°C
<b>Typical values</b>		
Repeatability (at nominal load)	70 mg	70 mg
Linearity deviation	70 mg	70 mg
Minimum sample weight (acc. to USP)	120 g	120 g
Minimum sample weight (U=1 %, k=2)	12 g	12 g
Minimum sample weight OIML	5 g	5 g
Settling time	1 s	1 s
Adjustment	Int. Cal / FACT	Ext. Cal
Interface	1 x RS232 / 2 x USB	1 x RS232 / 2 x USB
Balance dimensions (w x d x h)	200 x 319 x 100 mm	200 x 319 x 100 mm
Weighing pan dimensions	180 x 180 mm	180x180 mm
Weight of balance	3.7 kg	3 kg
<b>Weights for routine testing</b>		
OIML CarePac	#11123010	#11123010
Weights	2000 g F2, 200 g F2	2000 g F2, 200 g F2
ASTM CarePac	#11123110	#11123110
Weights	2000 g 4, 200 g 4	2000 g 4, 200 g 4

	ME4002T	ME4002TE
<b>Limit values</b>		
Maximum capacity	4200 g	4200 g
Readability	10 mg	10 mg
Repeatability (at nominal load)	10 mg	10 mg
Linearity deviation	20 mg	20 mg
Sensitivity temperature drift	3 ppm/°C	3 ppm/°C
<b>Typical values</b>		
Repeatability (at nominal load)	7 mg	7 mg
Linearity deviation	6 mg	6 mg
Minimum sample weight (acc. to USP)	14 g	14 g
Minimum sample weight (U=1 %, k=2)	1.4 g	1.4 g
Minimum sample weight OIML	0.5 g	0.5 g
Settling time	1.5 s	1.5 s
Adjustment	Int. Cal / FACT	Ext. Cal
Interface	1 x RS232 / 2 x USB	1 x RS232 / 2 x USB
Balance dimensions (w x d x h)	200 x 319 x 100 mm	200 x 319 x 100 mm
Weighing pan dimensions	180x180 mm	180x180 mm
Weight of balance	3.7 kg	3 kg
<b>Weights for routine testing</b>		
OIML CarePac	#11123010	#11123010
Weights	2000 g F2, 200 g F2	2000 g F2, 200 g F2
ASTM CarePac	#11123110	#11123110
Weights	2000 g 4, 200 g 4	2000 g 4, 200 g 4

	ME5002T	ME5002TE
<b>Limit values</b>		
Maximum capacity	5200 g	5200 g
Readability	10 mg	10 mg
Repeatability (at nominal load)	10 mg	10 mg
Linearity deviation	20 mg	20 mg
Sensitivity temperature drift	3 ppm/°C	3 ppm/°C
<b>Typical values</b>		
Repeatability (at nominal load)	7 mg	7 mg
Linearity deviation	6 mg	6 mg
Minimum sample weight (acc. to USP)	14 g	14 g
Minimum sample weight (U=1 %, k=2)	1.4 g	1.4 g
Minimum sample weight OIML	0.5 g	0.5 g
Settling time	1.5 s	1.5 s
Adjustment	Int. Cal / FACT	Ext. Cal
Interface	1 x RS232 / 2 x USB	1 x RS232 / 2 x USB
Balance dimensions (w x d x h)	200 x 319 x 100 mm	200 x 319 x 100 mm
Weighing pan dimensions	180 x 180 mm	180 x 180 mm
Weight of balance	3.7 kg	3 kg
<b>Weights for routine testing</b>		
OIML CarePac	#11123011	#11123011
Weights	5000 g F2, 200 g F2	5000 g F2, 200 g F2
ASTM CarePac	#11123111	#11123111
Weights	5000 g 4, 200 g 4	5000 g 4, 200 g 4

## 12.3 Dimensions

### 12.3.1 Balances with readability of 0.1 mg with draft shield high

**Models:**  
ME54T  
ME54TE  
ME104T  
ME104TE  
ME204T  
ME204TE

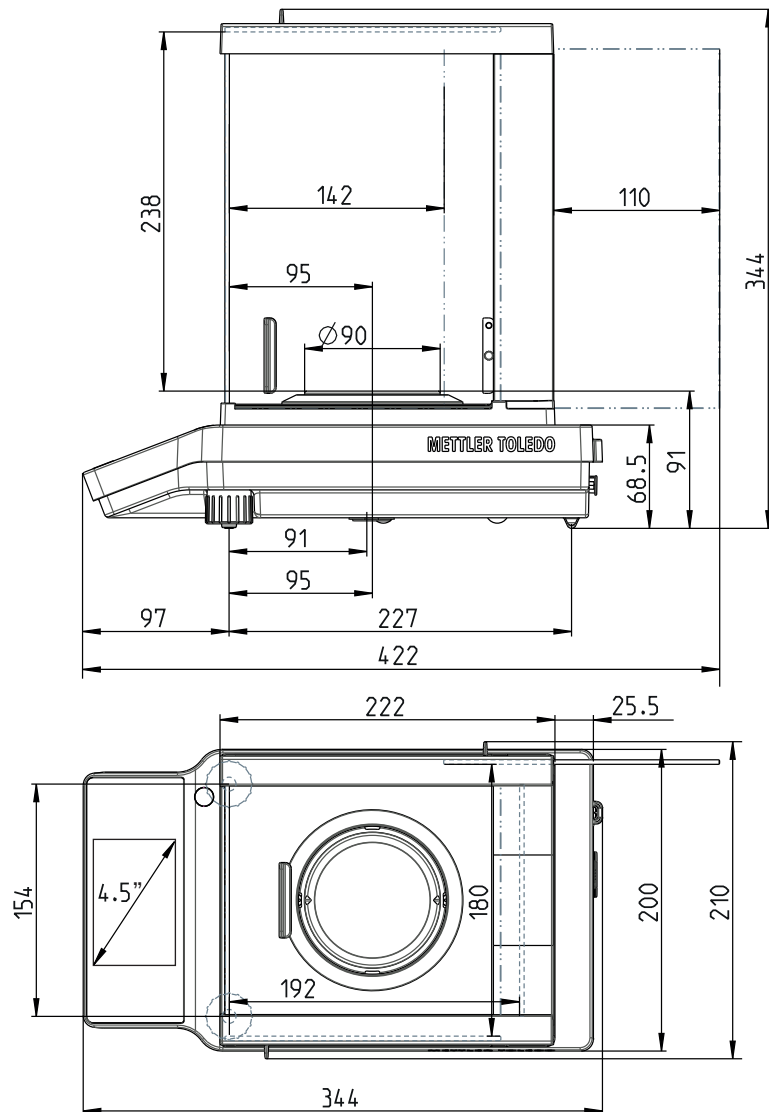

### 12.3.2 Balances with readability of 1 mg with draft shield low

**Models:**

- ME103T
- ME103TE
- ME203T
- ME203TE
- ME303T
- ME303TE
- ME403T
- ME403TE
- ME503T
- ME503TE

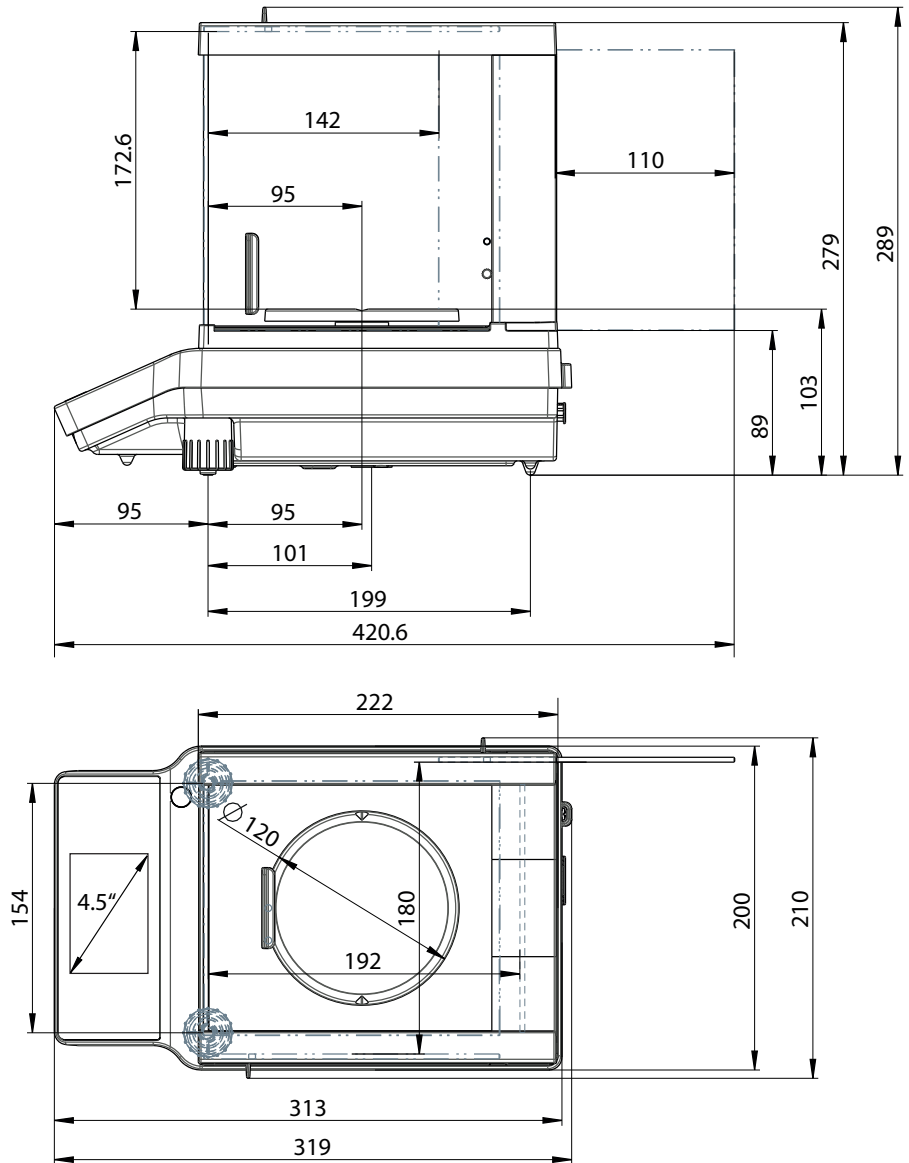

### 12.3.3 Balances with readability of 10 mg / 0.1 g

**Models:**

- ME1002T
- ME1002TE
- ME2002T
- ME2002TE
- ME3002T
- ME3002TE
- ME4001T
- ME4001TE
- ME4002T
- ME4002TE
- ME5002T
- ME5002TE

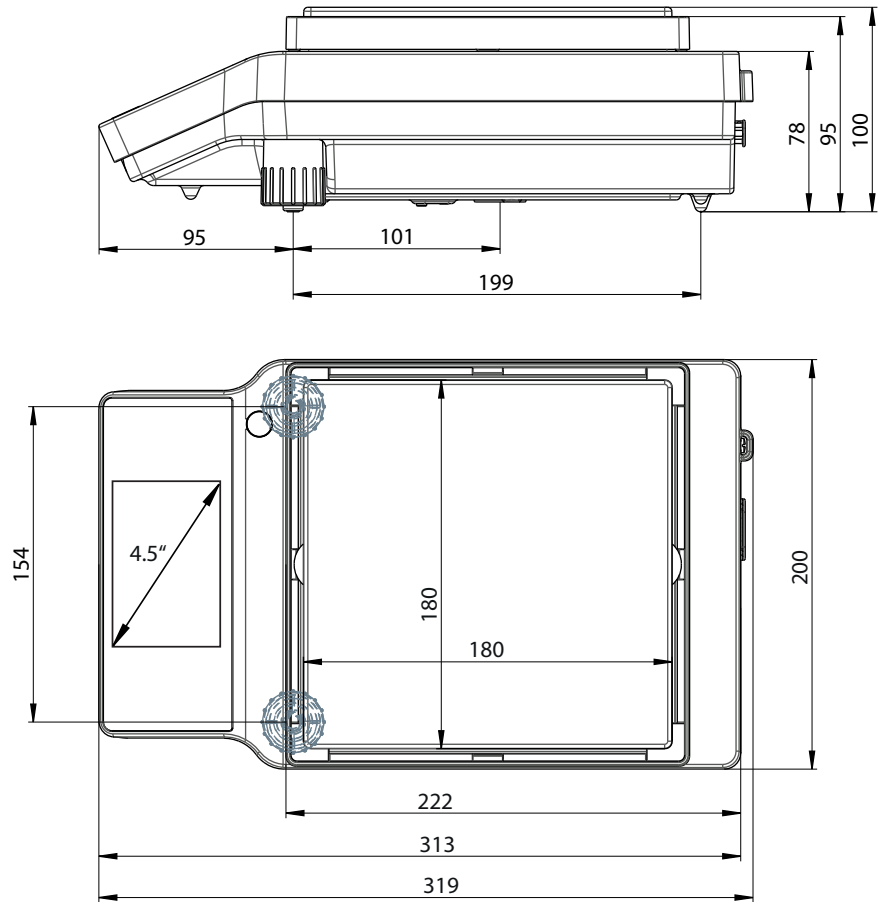

## 13 Accessories and Spare Parts

### Accessories

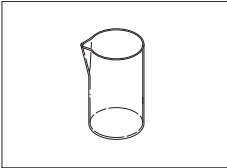
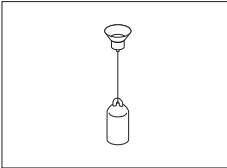
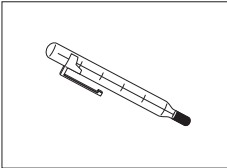
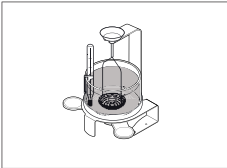
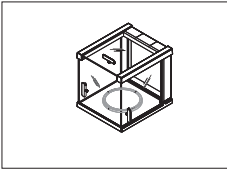
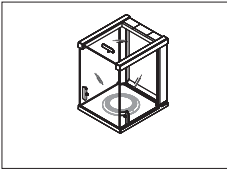
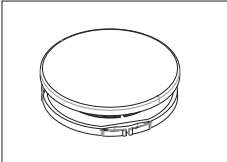
	Description	Part No.
<b>Density determination</b>		
	Glass beaker, height 100 mm, Ø 60 mm	00238167
	Sinker for density of liquids in conjunction with density kit Calibrated (sinkers + certificate) Recalibrated (new certificate)	00210260 00210672 00210674
	Calibrated thermometer with certificate	11132685
	Density kit ME-DNY-4 for NewClassic ME Balances 0.01 mg / 0.1 mg	30029886
<b>Draft shields</b>		
	Draft shield low with sliding doors, usable height 170 mm. <ul style="list-style-type: none"> <li>for balances 0.1 mg or 1 mg</li> <li>for balances 0.01 g or 0.1 g, weighing pan Ø 160 mm is needed (#30042896)</li> </ul>	30042884
	Draft shield high with sliding doors, usable height 235 mm <ul style="list-style-type: none"> <li>for balances 0.1 mg or 1 mg</li> <li>for balances 0.01 g or 0.1 g, weighing pan Ø 160 mm is needed (#30042896)</li> </ul>	30037731
<b>Weighing pans</b>		
	Set of weighing pan Ø 160 mm with pan support for ME balances with readability of 0.01 g and 0.1 g using draft shield	30042896

## Printers

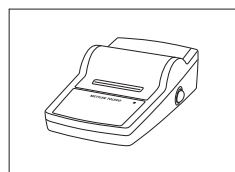

RS-P25 printer with RS232 connection to instrument	11124300
Paper roll (length: 20 m), set of 5 pcs	00072456
Paper roll (length: 13 m), self-adhesive, set of 3 pcs	11600388
Ribbon cartridge, black, set of 2 pcs	00065975

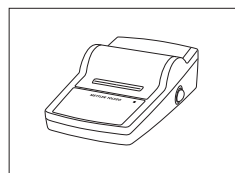

RS-P26 printer with RS232 connection to instrument (with date and time)	11124303
Paper roll (length: 20 m), set of 5 pcs	00072456
Paper roll, self-adhesive (length: 13 m), set of 3 pcs	11600388
Ribbon cartridge, black, set of 2 pcs	00065975

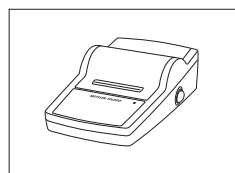

RS-P28 printer with RS232 connection to instrument (with date, time and applications)	11124304
Paper roll (length: 20 m), set of 5 pcs	00072456
Paper roll, self-adhesive (length: 13 m), set of 3 pcs	11600388
Ribbon cartridge, black, set of 2 pcs	00065975

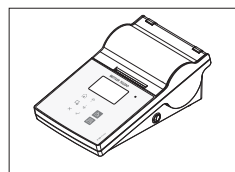

P-56RUE thermal printer with RS232, USB and ethernet connections, simple printouts, date and time, label printing (limited).	30094673
Paper roll, white (length: 27 m), set of 10 pcs	30094723
Paper roll, white, self-adhesive (length: 13 m), set of 10 pcs	30094724
Paper roll, white, self-adhesive labels (550 labels), set of 6 pcs	30094725

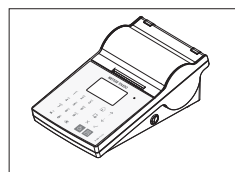

P-58RUE thermal printer with RS232, USB and ethernet connections, simple printouts, date and time, label printing, balance applications: statistics, formulation, totaling,	30094674
Paper roll, white (length: 27 m), set of 10 pcs	30094723
Paper roll, white, self-adhesive (length: 13 m), set of 10 pcs	30094724
Paper roll, white, self-adhesive labels (550 labels), set of 6 pcs	30094725

## Cables for RS232 interface

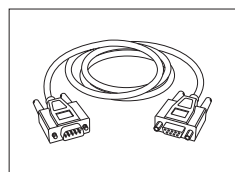

RS9 – RS9 (m/f): connection cable for PC, length = 1 m	11101051
--------------------------------------------------------	----------

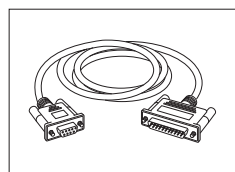

RS9 – RS25 (m/f): connection cable for PC, length = 2 m	11101052
---------------------------------------------------------	----------



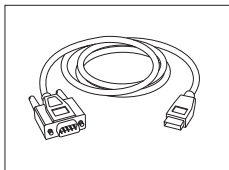

RS232 - USB converter cable – Cable with converter to connect a balance (RS232) to a USB port

64088427

### Cables for USB interface

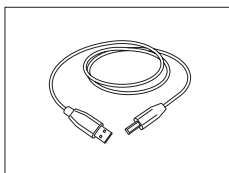

USB (A – B) connection cable for PC, length = 1 m

30241476

### Bluetooth RS232 serial adapters

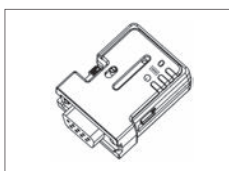

Bluetooth RS232 serial adapter ADP-BT-S for wireless connection between **printer** and Excellence balance\* or between **balance** and PC\*. Fits printers P-56 / P-58 and the following balance models (SW V2.20 or higher required): MS, MS-S/L, ML, MS-TS, ML-T, ME-T, PHS, JP, JS.

30086494

\* Bluetooth interface required

- 1 Bluetooth RS232 serial adapter (slave)
- 1 MT-DB9 male to female connector
- 1 MT-DB9 male to male connector

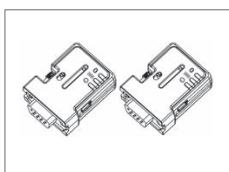

Bluetooth RS232 serial adapter set ADP-BT-P for wireless connection between printer and balance. Fits printers P-56 / P-58 and the following balance models (SW V2.20 or higher required): MS, MS-S/L, ML, MS-TS, ML-T, ME-T, PHS, JP, JS.

30086495

- 2 Bluetooth RS232 serial adapter paired (slave/master)
- 1 MT-DB9 male to female connector
- 1 MT-DB9 male to male connector

### Auxiliary displays

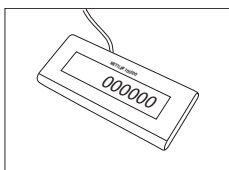

RS232 auxiliary display AD-RS-M7

12122381

### Power supplies

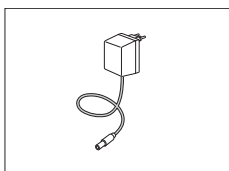

AC/DC universal adapter (EU, USA, AU, UK) 100–240 VAC, 50/60 Hz, 0.3 A, 12 VDC 0.84 A

11120270

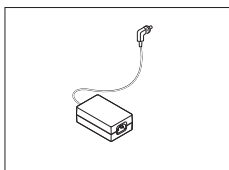

AC/DC adapter (without power cable) 100–240 V AC, 0.8 A, 50/60 Hz, 12 V DC 2.5 A

11107909

Power cable AU

00088751

Power cable BR

30015268

Power cable CH	00087920
Power cable CN	30047293
Power cable DK	00087452
Power cable EU	00087925
Power cable GB	00089405
Power cable IL	00225297
Power cable IN	11600569
Power cable IT	00087457
Power cable JP	11107881
Power cable TH, PE	11107880
Power cable US	00088668
Power cable ZA	00089728

### Pan protections

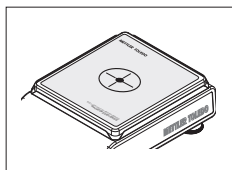

Protective foils, 175x175 mm, set of 20 pcs,  
pan protection for weighing pan 180x180 mm

30113802

### Protective covers

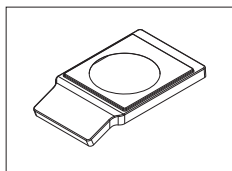

Protective cover for models with readability of 0.01 mg /  
0.1 mg

30241549

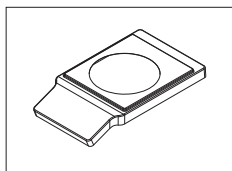

Protective cover for models with readability of 1 mg ... 0.1 g

30241560

### Dust covers

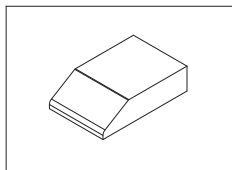

Dust cover for models without draft shield

30029051

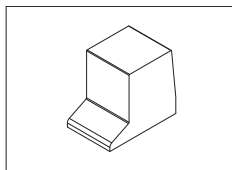

Dust cover for models with draft shield low (170 mm)

30029050

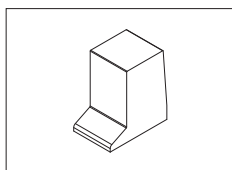

Dust cover for models with draft shield high (235 mm)

30029049

### Anti-theft devices

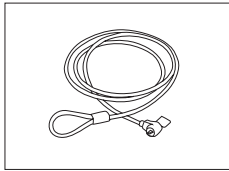

Steel cable

11600361

### Software

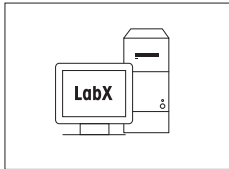

LabX direct balance (simple data transfer)

11120340

### Transport cases

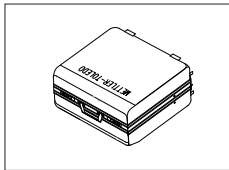

Transport case for ME-T balances:  
0.01 mg / 0.1 mg (draft Shield 235 mm)  
0.001 g (Draft Shield 170 mm)  
models without draft shield

30046404

30046405

30046406

### Adjustment weights



OIML / ASTM Weights (with calibration certificate)  
see <http://www.mt.com/weights>

### Miscellaneous

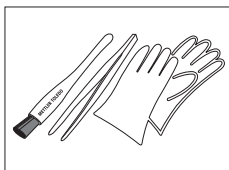

Tool kit, contains brush, tweezers and glove

30046403

### Spare Parts

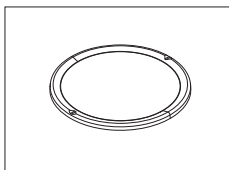

Weighing pan  $\varnothing$  90 mm incl. pan support, 0.1 mg

30037737

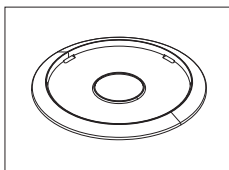

Draft shield element, 0.1 mg

12122043

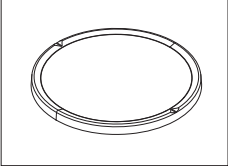
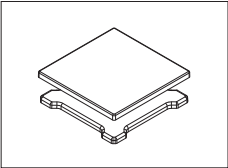
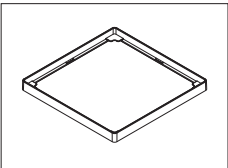
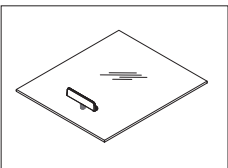
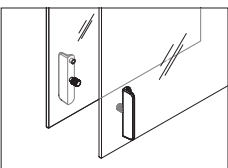
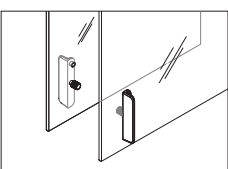
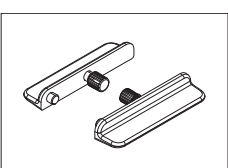
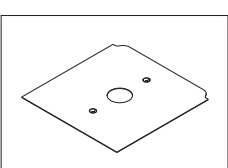
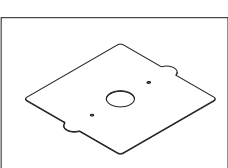
	Weighing pan $\varnothing$ 120 mm incl. pan support, 1 mg	30042889
	Weighing pan 180 x 180 mm with pan support, 0.01 g and 0.1 g	30042895
	Draft shield element 180 x 180 mm, 0.01/0.1 g	30042897
	Sliding top door for draft shield high or low with mounted handle (170 mm or 235 mm)	30037733
	Pair of sliding side doors for draft shield high with mounted handles (left and right), 235 mm	30037732
	Pair of sliding side doors for draft shield low with mounted handles (left and right), 170 mm	30042885
	Pair of handles for sliding doors of draft shield	30037736
	Bottom plate for draft shield	30037739
	Bottom plate for models without draft shield	30042901

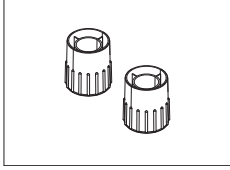

Pair of leveling feet

30037744

## 14 Appendix

### 14.1 Weighing Units

The following units can be chosen as main unit depending on the balance model and the country-specific balance version.

Unit	Unit name
g	Gram
kg	Kilogram
mg	Milligram
ct	carat
lb	Pound
oz	Ounce (avdp)
ozt	Ounce (troy)
GN	Grain
dwt	Pennyweight
mom	Momme
msg	Mesghal
tlh	Tael Hong Kong
tls	Tael Singapore (Malaysia)
tlt	Tael Taiwan
tlc	Tical
tola	tola
baht	baht

# Index

## A

Access protection	73
Accessories	101
Action buttons	12
Activities	12
Check Weighing	52
Counting	40
Dynamic Weighing	48
Factor Weighing	56
Formula	46
Percent Weighing	44
Totaling	57
Weighing	39
Applications	38
Adjusting	25
Adjustments	59
Adjustments and Tests	59
Ambient conditions	21
Application home screen	12
Assign to sample	36
Autoincrement	36
Autopublish	70

## B

Backlight	72
Balance History	73
Balance Information	12
Baud rates	80
Baudrate	71
Beep	67
Bit/Parity	71

## C

Changing the resolution	32
Changing the time	14
Check Weighing	52
Cleaning	78
Coach text field	12
Components	8
Conventions and Symbols	5
Counting	40

## D

Date format	66
Defining reference piece number	40
Defining statistics	37

Defining the measuring time	48
Defining tolerance threshold	53
Devices and connectivity	71
Dimensions	98
Discard value	57
Display results	47
Disposal	79
Dosing	68
Draft Shield	78
Dynamic Weighing	48

## E

Entering Characters and Numbers	13
Environment	68
Error messages	77
External Adjustment	62

## F

FACT	60
Factor Weighing	56
Fill up	46
Fill up sample	46
Formula	46
Fully Automatic Calibration Technology	60

## G

General configuration and data	68
Devices and connectivity	71
Publishing	69
System settings	72
USB Device	71
Weighing options	68
General safety information	6
General settings	66

## H

Handles	78
Handshake	71, 80
History	73
Host	81

## I

Identification dialog screen	34
In use cover	
see protective cover	20
Information and work bars	12
Information fields	12

Input prompt	36
Installing	
Components	18
Handles	78
Intended use	6
Interface	
MT-SICS	82
USB Device	81
Internal Adjustment	61
Internal Weight	61
Introduction	5
ISO-Log	73

## L

Language	67
Quick settings/Preferences	67
Leveling the balance	22
Location	21

## M

Main activity configuration	12
Main navigation	12
Measuring time	48
MT-SICS	82

## N

Navigation	27
------------	----

## O

Operating temperature	25
Overview	8, 26

## P

PC-Direct	74
PC-Direct Function	74
Percent Weighing	44
Performing a dynamic weighing	48
Performing a simple weighing	28
Performing Formula	46
Power supply	21
Print	12, 69
Protective cover	20
Publishing	69

## R

Reference piece number	40
Reset Balance	72
RS232	71
RS232 Interface	80

## S

Safety Information	
General	6
Intended use	6
Signal words	6
Staff safety	6
Warning Symbols	6
Selecting the location	21
Send value	70
Service	78
Setting FACT	60
Setting/Preferences	12
Short balance information	12
Signal words	6
Simple weighing	28
Sleep Mode	72
Sound	67
Spare parts	105
Staff safety	6
Statistics	37
Statistics configuration	37
Status information field	12
Switching	
On	25
Switching off	22
Switching on	22
Switching on the balance for the first time	22
Switching the weighing unit	30
Symbols	5
System and Data Management	72
System settings	72

## T

Taring	23
Technical data general	83
Technical data model-specific	84
Threshold	55
Time	66
Time format	66
Totaling	57
Touch beep	67
Touch Screen Adjustment	72
Transporting the balance	24

## U

USB Device	71
USB Device Interface	75, 81



USB driver installation	75
USB Host	81
User Interface	11

## **V**

---

Value bar	12
-----------	----

## **W**

---

Warm-up time	25
Warning Symbols	6
Weighing	39
Weighing below the balance	24
Weighing information bar	12
Weighing options	68
Weighing unit	12
Weighing value field	12
Weighing-in aid	12
Work title bar	12
Workflow Feedback Beep	67

## **Z**

---

Zero setting	22
Zeroing	22





# GWP®

Good Weighing Practice™

---

GWP® is the global weighing standard, ensuring consistent accuracy of weighing processes, applicable to all equipment from any manufacturer. It helps to:

- Choose the appropriate balance or scale
- Calibrate and operate your weighing equipment with security
- Comply with quality and compliance standards in laboratory and manufacturing

▶ [www.mt.com/GWP](http://www.mt.com/GWP)

[www.mt.com/balances](http://www.mt.com/balances)

For more information

**Mettler-Toledo GmbH**

Im Langacher 44  
8606 Greifensee, Switzerland  
[www.mt.com/contact](http://www.mt.com/contact)

Subject to technical changes.  
© Mettler-Toledo GmbH 02/2016  
30203916B en



\* 3 0 2 0 3 9 1 6 \*