

MC series

Mass comparator

INSTRUCTION MANUAL

MC-100KS



A&D

A&D Company, Limited

1WMPD4002666

This Manual and Marks

All safety messages are identified by the following, "WARNING" or "CAUTION", of ANSI Z535.4 (American National Standard Institute: Product Safety Signs and Labels). The meanings are as follows:

 WARNING	A potentially hazardous situation which, if not avoided, could result in death or serious injury.
 CAUTION	A potentially hazardous situation which, if not avoided, may result in minor or moderate injury.



This is a hazard alert mark.

- This manual is subject to change without notice at any time to improve the product.
- The contents of the product specifications and this manual are subject to change without any obligation on the part of the manufacturer.
- Under the copyright laws, the software (program) described in it are copyrighted, with all rights reserved.
The software may be installed into one computer and may not be installed into other computers without the prior written consent of A&D Company. Copying includes translation into another language, reproduction, conversion, photocopy and offer or loan to another person.

- Microsoft, Windows, Word and Excel are registered trademarks of the Microsoft Corporation.

© 2013 A&D Company, Limited All rights reserved.

No part of this publication may be reproduced, transmitted, transcribed, or translated into any language in any form by any means without the written permission of A&D Company, Limited.

Contents

Basic Operation

1.	Introduction	3
1-1.	About This Manual	3
1-2.	Features.....	3
1-3.	Compliance.....	4
1-3-1.	Compliance with FCC Rules	4
1-3-2.	Compliance with EMC Directives.....	4
2.	Unpacking And Installing The Balance.....	5
2-1.	Installing the Balance	6
3.	Precautions	7
3-1.	Before Use.....	7
3-2.	During Use.....	8
3-3.	After Use	9
3-4.	Power Supply	9
4.	Display Symbols And Key Operation	10
5.	Weighing Units	11
6.	Weighing	13
6-1.	Selecting a Weighing Unit (Mode)	13
6-2.	Basic Weighing.....	13
6-2-1.	For More Stable Weighing.....	13
6-2-2.	When Using as a Mass Comparator.....	13
6-2-3.	When Building into a System	14

Adapting to the Environment

7.	Weighing Speed Adjustment / Self Check Function	15
7-1.	Weighing Speed Adjustment.....	15
7-2.	Self Check Function with Response Adjustment	16
8.	Calibration.....	17
8-1.	Calibration Group	17
8-2.	Automatic Self Calibration.....	18
8-3.	One-Touch Calibration	19
8-4.	Calibration Using an External Weight.....	20
8-5.	Calibration Test Using an External Weight	21
8-6.	Correcting the Internal Mass Value.....	22

Functions

9.	Function Switch And Initialization.....	24
9-1.	Permit or Inhibit.....	24
9-2.	Initializing the Balance.....	25
10.	Function Table.....	26
10-1.	Sequence of the Function Table	26
10-2.	Display and Operation Keys	26
10-3.	Details of the Function Table	27
10-4.	Description of the Class "Environment, Display"	31
10-5.	Description of the Item "Data Output Mode"	32

10-6.	Description of the Item "Data Format"	33
10-6-1.	Description of the Data Format Added to the Weighing Data.....	35
10-7.	Data Format Examples	36
11.	ID Number And GLP Report.....	37
11-1.	Setting the ID Number.....	37
11-2.	GLP Report.....	38

RS-232C Serial Interface

12.	Standard Input And Output Interface	41
12-1.	RS-232C and External Contact Input	41
12-2.	Connection to Peripheral Equipment.....	43
12-2-1.	Connection to the AD-8121B Printer	43
12-2-2.	Connection to a Computer and the Use of WinCT	44
13.	Commands.....	45
13-1.	Command List	45
13-2.	Acknowledge Code and Error Codes	46
13-3.	Control Using CTS and RTS.....	47
13-4.	Settings Related to RS-232C.....	47
14.	Extended Function	48
14-1.	Description of "Averaging range" and "Averaging time"	49
14-1-1.	Averaging Range (<i>F l-b</i>) and Averaging Time (<i>F l-t</i>).....	49
14-1-2.	Filter Depending on Differences in the Amount to Deliver Powdery and Liquid Material.....	50

Maintenance

15.	Maintenance	51
15-1.	Treatment of the Balance.....	51
16.	Troubleshooting	52
16-1.	Checking the Balance Performance and Environment.....	52
16-2.	Error Codes	53
16-3.	Other Display	55
16-4.	Asking for Repair	55
17.	Specifications	56
17-1.	External Dimensions	57
17-2.	Options and Peripheral Instruments	58
18.	Terms/Index	61
18-1.	Terms	61
18-2.	Index	63

1. Introduction

This manual describes how the MC Series Mass Comparator Balance, MC-100KS works and how to get the most out of it in terms of performance.

Read this manual thoroughly before using the balance and keep it at hand for future reference.

For other functions and operations that this manual does not describe, refer to the GP series instruction manual.

1-1. About This Manual

This manual consists of the following five parts:

Basic operation Describes precautions, the balance's construction and basic operation.

Adapting to the environment Describes response (and stability) adjustment to adapt to the environment where there is vibration or drafts, the way to maintain weighing precision in a variation of ambient temperature, calibration and calibration test.

Selecting functions..... Describes functions of the balance.

Interface and communication ... Describes the RS-232C serial interface and external contact input. The RS-232C serial interface can communicate with a computer that requests weighing data and controls the balance. This RS-232C interface is for use with a computer or printer. The external contact input commands the balance re-zeroing and data output.

Maintenance Describes maintenance, error codes, troubleshooting, specifications and options.

1-2. Features

- Display resolution, one digit greater than a standard balance. This allows management of OIML class M1 or lower weights.
- Capable of weighing small amounts of powdery or liquid material, even with a massive tare.

1-3. Compliance

1-3-1. Compliance with FCC Rules

Please note that this equipment generates, uses and can radiate radio frequency energy. This equipment has been tested and has been found to comply with the limits of a Class A computing device pursuant to Subpart J of Part 15 of FCC rules. These rules are designed to provide reasonable protection against interference when equipment is operated in a commercial environment. If this unit is operated in a residential area, it may cause some interference and under these circumstances the user would be required to take, at his own expense, whatever measures are necessary to eliminate the interference.

(FCC = Federal Communications Commission in the U.S.A.)

1-3-2. Compliance with EMC Directives

CE This device features radio interference suppression and safety regulation in compliance with the following Council Directives

Council directive 89/336/EEC EN61326 EMC directive

Council directive 73/23/EEC EN60950 Safety of Information Technology Equipment

- The CE mark is an official mandatory European marking.
Please note that any electronic product must comply with local laws and regulations when sold or used anywhere outside Europe.

2. Unpacking And Installing The Balance

- The balance is a precision instrument. Unpack the balance carefully. Keep the packing material to be used for transporting the balance in the future.
- After unpacking, see the illustrations to confirm that everything is included.

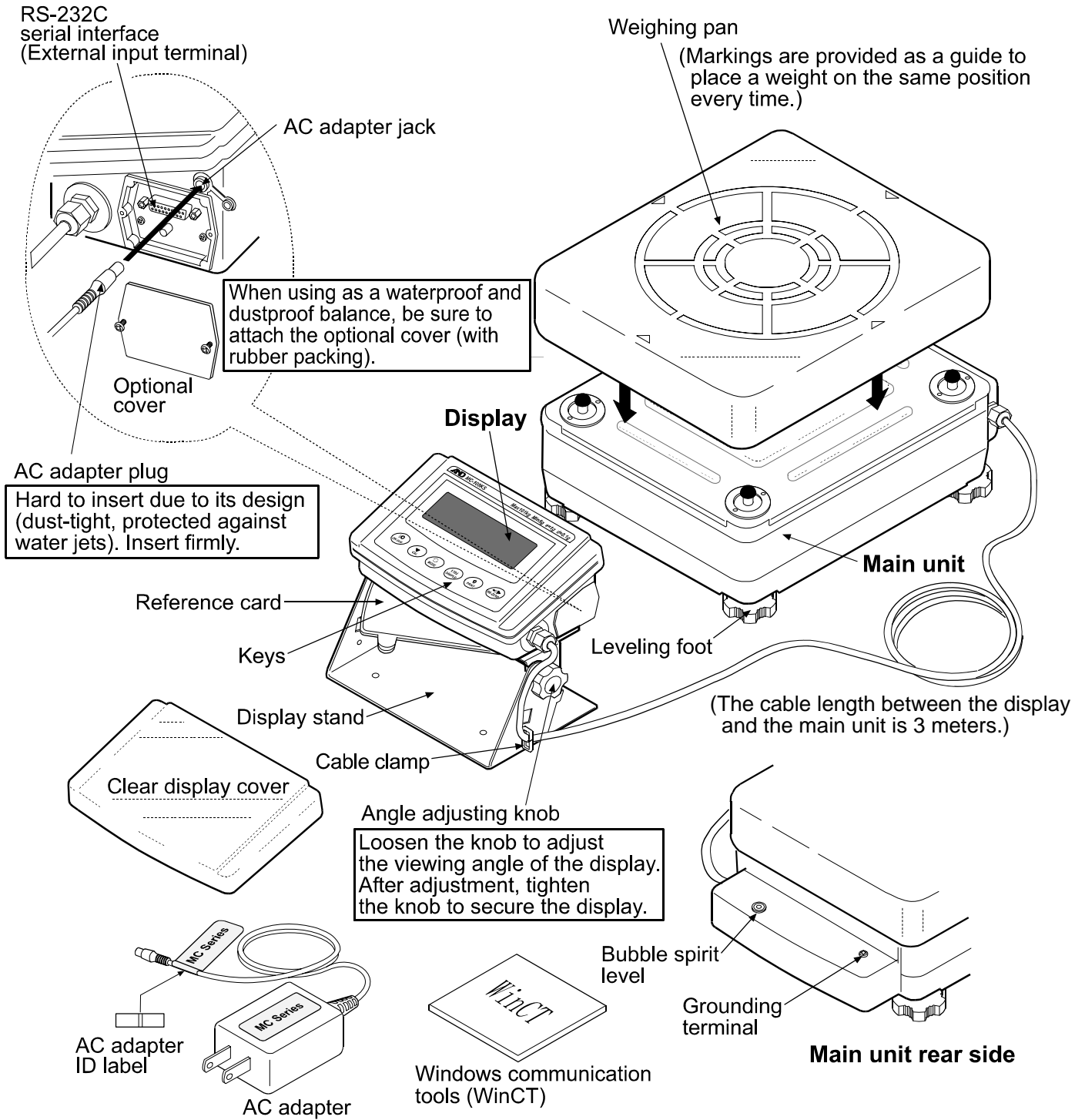

Note Please confirm that the AC adapter type is correct for your local voltage and receptacle type.

2-1. Installing the Balance

Install the balance as follows:

- 1 Refer to "3. Precautions" for installing the balance.
- 2 Adjust the leveling feet to level the balance. Confirm it using the bubble spirit level.
- 3 Confirm that the AC adapter type is correct for the local voltage and receptacle type.
- 4 Insert the AC adapter firmly into the AC adapter jack on the balance. Ground the balance. Warm up the balance for at least 30 minutes with nothing on the weighing pan.

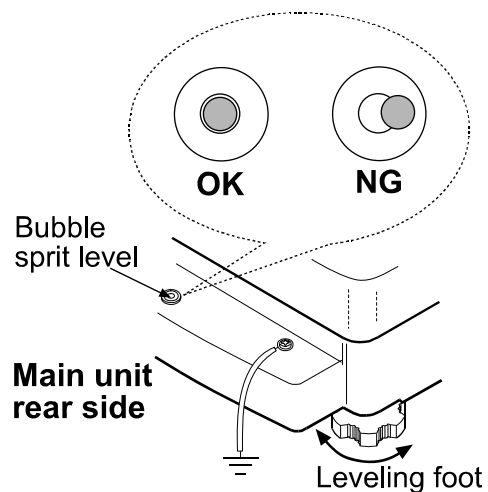

3. Precautions

To get the optimum performance from the balance and acquire accurate weighing data, note the following:

3-1. Before Use

- The maximum resolution of the precision balance is million counts. Therefore, there are tendencies to be influenced by temperature change, air pressure change, static electricity, vibration and drafts where the balance is placed.
- Install the balance in an environment where the temperature and humidity are not excessive. The best operating temperature is about 20°C / 68°F at about 50% relative humidity.
- Install the balance where it is not exposed to direct sunlight and it is not affected by heaters or air conditioners.
- Install the balance where it is free of dust.
- Install the balance away from equipment that produces magnetic fields.
- Install the balance in a stable place avoiding vibration and shock. Corners of rooms on the first floor are best, as they are less prone to vibration.
- The weighing table should be solid and free from vibration, drafts and as level as possible.
- Level the balance by adjusting the leveling feet and confirm it using the bubble spirit level.
- If static electricity is a problem at the installation site, use the electrostatic field meter and the static eliminator.
- Ensure a stable power source when using the AC adapter.
- Connect the AC adapter and warm up the balance for at least 30 minutes.
- Calibrate the balance periodically for accurate weighing.
- When the balance is installed for the first time or has been moved, warm up the balance for at least 6 hours to allow the balance to reach equilibrium with the ambient temperature, and then perform calibration before use.
- The meaning of IP-65 is "No ingress of dust. Protected against water jets". If a powerful water jet is used or the balance is immersed in water, it may cause a damage that is due to ingress of water.
- Confirm that "the AC adapter plug is inserted firmly into the AC adapter jack" and "the RS-232C serial interface terminal is covered using the optional waterproof cover, when using as a waterproof and dustproof balance.
- When performing data transmission using the RS-232C serial interface, the balance does not comply with IP-65 (waterproof and dustproof).

 Do not install the balance where flammable or corrosive gas is present.

3-2. During Use

- Discharge static electricity from the weighing material. When weighing sample (plastics, insulator, etc.) could have a static charge, the weighing value is influenced. Ground the balance, and
 - Eliminate the static electricity by using an optimal static eliminator, AD-1683.
 - Or try to keep the ambient humidity above 45%RH at the room.
 - Or use the metal shield case.
 - Or wipe a charged material (plastic sample etc.) with the wet cloth.
- This balance uses a strong magnet as part of the balance assembly, so please use caution when weighing magnetic materials such as iron. If there is a problem, use the underhook on the bottom of the balance to suspend the material away from the influence of the magnet.
- Eliminate any temperature difference between the sample and the environment. When a sample is warmer (cooler) than the ambient temperature, the sample will be lighter (heavier) than the true weight. This error is due to a rising (falling) draft around the sample.
- Make each weighing gently and quickly to avoid errors due to changes in the environmental conditions.
- Do not drop things upon the weighing pan, or place a sample on the pan that is beyond the balance weighing capacity. Place the sample in the center of the weighing pan.
- Do not use a sharp instrument such as a pencil to press the keys. Use your finger only.
- Press the **RE-ZERO** key before each weighing to prevent possible errors.
- Calibrate the balance periodically so as to eliminate possible errors.
- Take into consideration the affect of air buoyancy on a sample when more accuracy is required.
- The reference card is provided to refer for basic operations.
- Prevent foreign matter, such as powder, liquid and metal, from invading the area around the weighing pan.

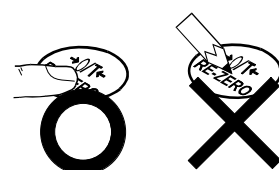
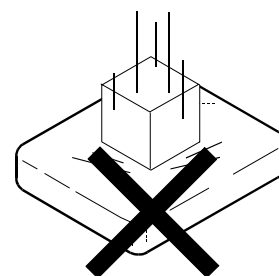
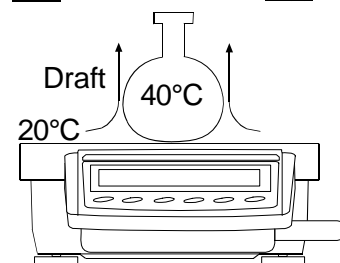
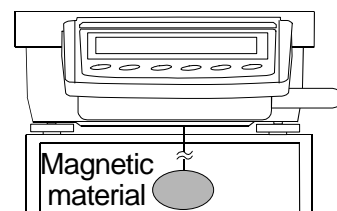
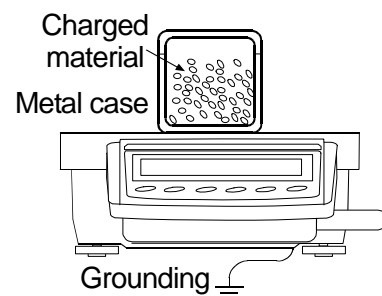

3-3. After Use

- Avoid mechanical shock to the balance.
- Do not disassemble the balance. Contact the local A&D dealer if the balance needs service or repair.
- Do not use organic solvents to clean the balance. Clean the balance with a lint free cloth that is moistened with warm water and a mild detergent.
- Do not allow the balance to be immersed in water. Even though the balance complies with IP code, the balance will not withstand being completely immersed in water.
- The weighing pan can be removed to clean the balance. Clean by splashing with water.

3-4. Power Supply

- Do not remove the AC adapter while the internal mass is in motion, for example, immediately after the AC adapter is connected, or during calibration using the internal mass.
If the AC adapter is removed under the conditions described above, the internal mass will be left unsecured, that may cause mechanical damage when the balance is moved. Before removing the AC adapter, press the key and confirm that zero is displayed.
- When the AC adapter is connected, the balance is in the standby mode if the standby indicator is on. This is a normal state and does not harm the balance. For accurate weighing, keep the AC adapter connected to the balance unless the balance is not to be used for a long period of time.

4. Display Symbols And Key Operation

Key Operations

Key operation affects how the balance functions. The basic key operations are:



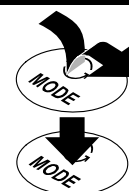

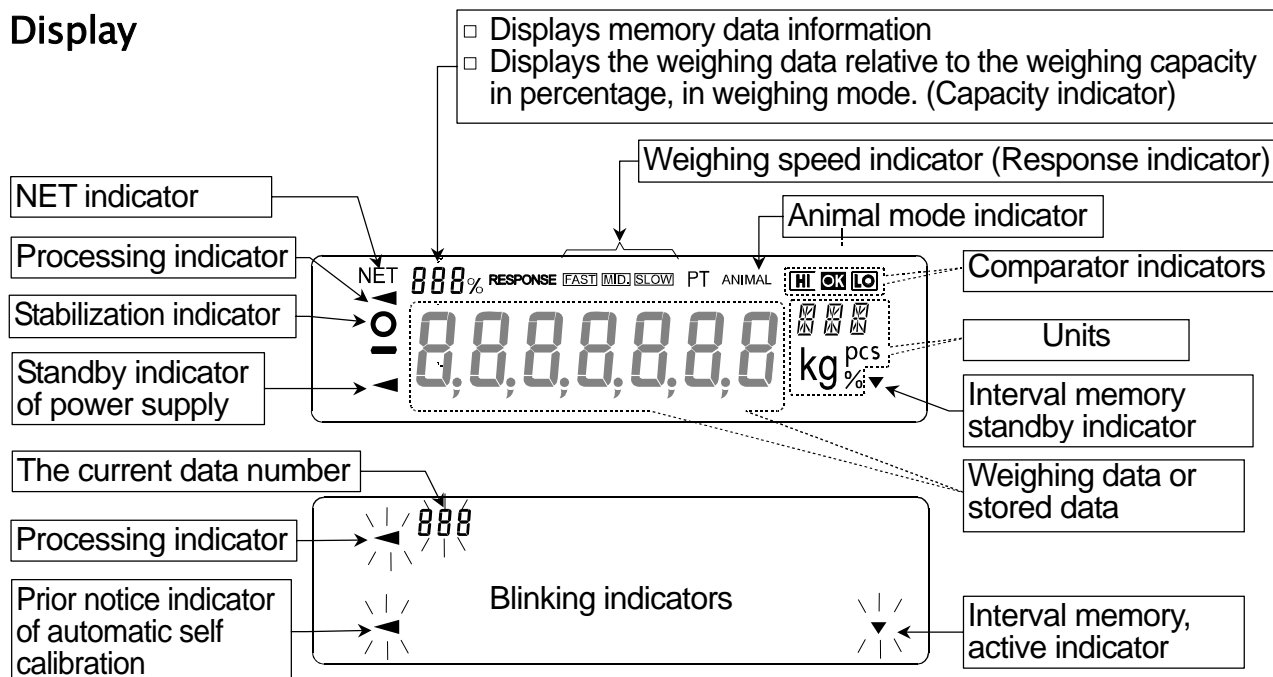

- "Press and release the key immediately" or "Press the key"
= normal key operation during measurement
- "Press and hold the key".



Display



Each key, when pressed or when pressed and held, functions as follows:

Key	When pressed and released	When pressed and held
	Turns the display ON and OFF. The standby indicator is displayed when the display is turned off. The weighing mode is enabled when the display is turned on. This key is available anytime. Pressing the key during operation will interrupt the operation and turn the display OFF.	
	In the weighing mode, turns the minimum weighing value ON and OFF. In the counting or percent mode, enters the sample storing mode.	Enters the function table mode. Refer to "10. Function Table".
	No function at the factory setting. Switches the weighing units when units other than "g" are stored in the function setting.	Performs weighing speed adjustment (response adjustment) and self check.
	Performs calibration using the internal mass.	Displays other items of the calibration menu.
	Stores the weighing data in memory or outputs to a printer or personal computer depending on the function table settings. (Factory setting = output)	No function at the factory setting. By changing the function table: <ul style="list-style-type: none"> □ Outputs "Title block" and "End block" for the GLP/GMP compliant report. Refer to "11-2. GLP Report". □ Displays the data memory menu.
	Sets the display to zero.	

5. Weighing Units

- With the balance, only the unit "g" (gram) was set at the factory.
The following weighing units and weighing modes are available for selection:

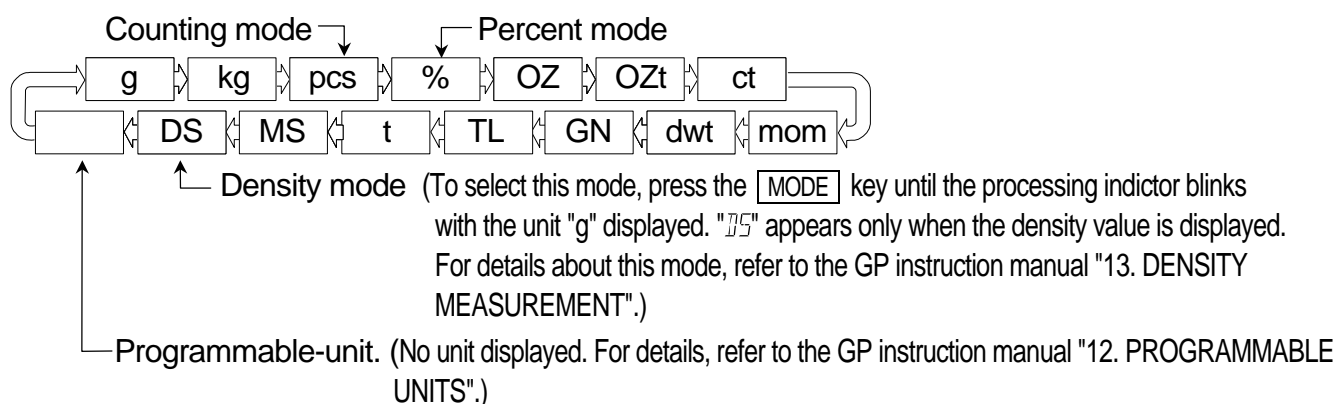

A unit or mode can be selected and stored in the function table as described in the GP series instruction manual "4-2. Changing the Units".

If a weighing mode (or unit of weight) has been turned off, that mode or unit will be missing in the sequence. Tael has four varieties, one of which can be selected and installed at the factory.

For details about the units and modes, see the table below:

Name (unit, mode)	Abbreviation	Display	Function table (Storing mode)	Conversion factor 1 g =
Gram	g	g	g	1 g
Kilogram	kg	kg	kg	1000 g
Counting mode	pcs	pcs	pcs	—
Percent mode	%	%	%	—
Ounce (Avoir)	OZ	<i>OZ</i>	<i>OZ</i>	28.349523125 g
Troy Ounce	OZt	<i>OZt</i>	<i>OZt</i>	31.1034768 g
Metric Carat	ct	<i>ct</i>	<i>ct</i>	0.2 g
Momme	mom	<i>mom</i>	<i>mom</i>	3.75 g
Pennyweight	dwt	<i>dwt</i>	<i>dwt</i>	1.55517384 g
Grain (UK)	GN	<i>GN</i>	<i>GN</i>	0.06479891 g
Tael (HK general, Singapore)	TL	<i>TL</i>	<i>TL</i>	37.7994 g
Tael (HK jewelry)				37.429 g
Tael (Taiwan)				37.5 g
Tael (China)				31.25 g
Tola (India)	t	<i>t</i>	<i>t</i>	11.6638038 g
Messghal	MS	<i>MS</i>	<i>MS</i>	4.6875 g
Density mode	DS	<i>DS</i> <i>DS</i> is used to show the density	<i>DS</i>	—
Programmable-unit (Multi-unit)	Mlt	—	<i>Mlt</i>	—

- The tables below indicate the weighing capacity and the minimum display for each unit, depending on the balance model.
- When a measurement unit other than gram is used, it is not possible to weigh up to capacity of the balance because the display does not have sufficient digits.
Use the MC series balance within the values shown in the tables below.

Unit	MC-100KS	
	Capacity	Minimum display
Gram	101000 g	0.1
Kilogram	101 kg	0.0001
Ounce (Avoir)	3562 OZ	0.005
Troy Ounce	3247 OZt	0.005
Metric Carat	505000 ct	0.5
Momme	26933 mom	0.05
Pennyweight	64945 dwt	0.1
Grain (UK)	1558668 GN	2
Tael (HK general, Singapore)	2672 TL	0.005
Tael (HK jewelry)	2698 TL	0.005
Tael (Taiwan)	2693 TL	0.005
Tael (China)	3232 TL	0.005
Tola (India)	8659 t	0.01
Messghal	21546 MS	0.05

6. Weighing

6-1. Selecting a Weighing Unit (Mode)

Press the **MODE** key to select a unit or mode for weighing.

The unit “g” (gram) was set at the factory.

To use other units, select and store units and displaying order in the function setting of “Unit”. For details on weighing unit storing procedure, refer to the GP series instruction manual, “4-2. Changing the Units”.

6-2. Basic Weighing

6-2-1. For More Stable Weighing

- To reduce the influence of drafts and vibration, set the following function settings as below.

“Condition (Cond)” of “Environment, Display (bRSFnC)” to “Slow (2)”

“Filter (FIL)” of “Environment, Display (bRSFnC)” to “Used (I)”

Function Settings

Refer to “10. Function Table” on page 26 to check or change the function settings.

Class	Item and Parameter		Description
bRSFnC	Cond	Condition	2 Slow response rate, stable value SLOW
Environment Display	FIL	Filter	I Used

6-2-2. When Using as a Mass Comparator

- To avoid eccentric loading errors, place the sample in the center of the weighing pan. The weighing pan has markings as a guide to place a weight on the same position every time.

Using an AD-8922A remote controller, which is sold separately, the balance can be controlled remotely by the AD-8922A key operations in the same way as when the **CAL** or **RE-ZERO** key of the balance is pressed. For the connection procedure between the balance and the AD-8922A, refer to the AD-8922A instruction manual.

- Take measures against causes of weighing error at the installation site, such as changes in temperature, atmospheric pressure, drafts, vibration and static electricity. Perform weighing operations in an stable environment.
- The table below lists the weight class and recommended measuring range for the MC-100KS. The measuring range is determined so that the balance repeatability is to be less than one third of the maximum permissible error for each weight class.

Weight class and recommended measuring range

		M C - 1 0 0 K S	
		M 1	M 2
Weight (Displayed value)	100 kg	↑ ↓	↑ ↓
	50 kg		
	20 kg		
	10 kg		

M 1
 M 2

6-2-3. When Building into a System

- When a special weighing pan is to be designed, the weight of the pan and the material to be weighed should not exceed the weighing capacity of the balance.
To reduce influences of static electricity and magnetism, use materials other than resin and magnetic material such as iron.
- There is a function available to maintain the previous weight value in non-volatile memory, even if the AC adapter is removed.
When “Zero upon power-on ($P-tr$)” of “Environment, Display ($bR5FnC$)” is set to “ 1 ”, the previous weight value is displayed upon power-on.
For details, refer to “Zero upon power-on” on page 31.
- There is a function available to perform span calibration only, when performing calibration with a tare on the weighing pan.
When “Span calibration (SPn)” of “Environment, Display ($bR5FnC$)” is set to “ 1 ”, span calibration using the internal mass is performed, with a tare on the weighing pan.
For details, refer to “Span calibration” on page 31.
- To set a higher response rate (weighing speed) or to batch-weigh small amounts of material, such as a powdery material, refer to “14. Extended Function”.

7. Weighing Speed Adjustment / Self Check Function

7-1. Weighing Speed Adjustment

This function detects the influence on weighing that is caused by drafts and/or vibration at the place where the balance is installed and sets the following three weighing speeds (response characteristics) automatically.

The function has three rates as follows:

Changing the weighing speed changes the display refresh rate.

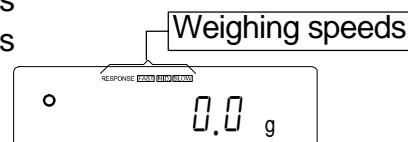

Indicator	Parameter	Weighing Speed	Stability	Display refresh rate
FAST	[Cond 0]	Fast response, ↑ Slow response,	Sensitive value ↓ Stable value	If the weighing speed is changed as follows: MID. or SLOW FAST = 10 times/second FAST MID. or SLOW = 5 times/second
MID.	[Cond 1]			
SLOW	[Cond 2]			

Step 1 Press and hold the [MODE] key until [RESPONSE] is displayed. And then, press the [MODE] key again quickly.

Step 2 Press the [MODE] key to select a weighing speed. Either [FAST], [MID.] or [SLOW] can be selected.

Step 3 After a few seconds of inactivity the balance displays [End]. Then, it returns to the weighing mode and displays the updated response indicator. The response indicator remains displayed for a while.

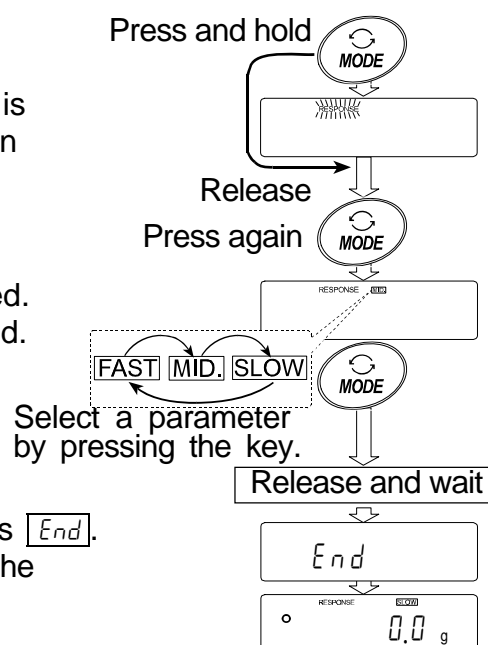

Note

- The weighing speed adjustment can be changed at "Condition ([Cond])" of "Environment, Display (bRSFnC)" in the function table. Refer to "10. Function Table" for details.
- To set a refresh rate of 5 times/second when the response rate is [FAST] or 10 times/second when the response rate is [MID.] or [SLOW], change the "Display refresh rate (SPd)" parameter of "Environment, Display (bRSFnC)" in the function table.
- If the weight value is not stabilized due to drafts or vibration when "[Cond 0]" is selected by the automatic response adjustment, change the parameter of "[Cond]" manually in the function table.

7-2. Self Check Function with Response Adjustment

This function automatically updates the response adjustment by analyzing the influence of the environment on the weighing data and also self-checks the balance performance using the internal mass.

Step 1 Press and hold the **MODE** key until **RESPONSE** is displayed, and then release the key.

Step 2 The balance automatically starts to check the balance performance and sets the response characteristic.

Caution Do not allow vibration or drafts to affect the balance during adjustment.

Step 3 After automatic adjustment, the balance displays the updated response indicator and returns to the weighing mode. The response indicator remains displayed for a while.

Example of display

MID and **OK** : The example of display indicates that the result of the self check is good and MID. is selected as the response rate.

Note

- If improper performance is found in the self check, the balance displays **[EH n0]**. Contact the local A&D dealer for repair.
- If the automatic response adjustment fails, the balance displays **[EH nG]**. Check the ambient conditions such as breeze and vibration, also check the weighing pan. Then, perform the adjustment again. To return to the weighing mode, press the **CAL** key.

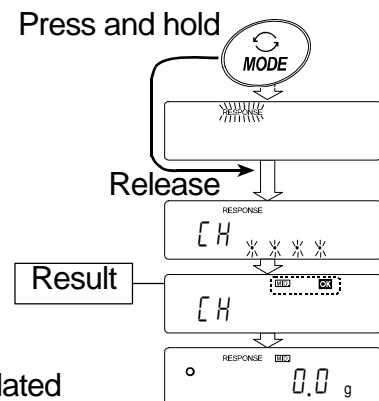

8. Calibration

8-1. Calibration Group

The balance has the following modes as a calibration group.

Calibration

- Automatic self calibration (Calibration due to changes in temperature)
- Calibration using the internal mass (One-touch calibration)
- Calibration using an external weight

Calibration Test

- Calibration test using an external weight (Calibration test does not perform calibration)

Correction of the internal mass value

Terms

The following terms are defined as follows:

- Internal mass = Built-in calibration weight
- External weight = A weight that you have. Referred to as a calibration weight when used for calibration.
- Calibration weight = A weight used for calibration
- Target weight = An external weight used for calibration test

Caution

- Calibration adjusts the balance for accurate weighing.
Besides periodic calibration and before each use, perform calibration when:
 - The balance is installed for the first time.
 - The balance has been moved.
 - The ambient environment has changed.
- Do not allow vibration or drafts to affect the balance during calibration.
- To output the GLP/GMP compliant report using the RS-232C interface, set "GLP output (*info*)" of "Data output (*dout*)". Refer to "10. Function Table". Time and date can be added to the GLP report. If the time or date is not correct, adjust them. Refer to the GP series instruction manual "9-9. Clock and Calendar Function".
- Calibration test is available only when "GLP output (*info*)" of "Data output (*dout*)" is set to "1" or "2",
- The calibration and calibration test data can be stored in memory. To store them, set "Data memory (*data*)" to "3". Refer to the GP series instruction manual "11. DATA MEMORY" for details.

Caution on using an external weight

- The accuracy of an external weight can influence the accuracy of weighing.
- Select an appropriate weight for calibration and calibration test from the following table.

Model	Usable calibration weight	Adjustable range
MC-100KS	60 kg, 80 kg, 100 kg	-15.0 g ~ +15.9 g

The calibration weight in **bold type**: factory setting

The calibration weight value can be adjusted within the range above.

Display



This indicator means "In process of measuring calibration data".

Do not allow vibration or drafts to affect the balance while the indicator is displayed.

8-2. Automatic Self Calibration

Automatic self calibration due to changes in temperature

This function automatically calibrates the balance when the balance detects an ambient temperature change. If GLP output is selected in the function table, the balance outputs the calibration report or stores the data in memory. Automatic self calibration functions even if the display is turned off (standby state). Refer to "9-1. Permit or Inhibit" for the operation.

Caution

- **If something is on the weighing pan, the balance judges that it is in use and does not perform automatic self calibration. To maintain the calibrated state, keep the weighing pan clear while not in use.**



Indicates that the balance detects a change in ambient temperature and automatic self calibration will start. If the balance is not used for a few minutes with this indicator blinking, the balance performs automatic self calibration. The blinking duration depends on the environment.

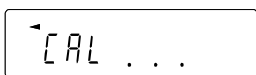

Indicates that the balance is measuring calibration data. Do not allow vibration or drafts to affect the balance while this indicator is displayed. After calibration, the balance returns to indicate the previous display.

Note The balance can be used while the indicator blinks. But, it is recommended that to maintain the accuracy, stop using the balance and confirm that there is nothing on the pan and allow the balance to perform self calibration.

8-3. One-Touch Calibration

Calibration using the internal mass

This function calibrates the balance using the internal mass. The only operation required is to press the **CAL** key.

- Step 1 Connect the AC adapter and warm up the balance for at least 30 minutes with nothing on the weighing pan.
- Step 2 Press the **CAL** key.
- Step 3 The balance displays **CRD** and performs calibration using the internal mass. Do not allow vibration or drafts to affect the balance.
- Step 4 The balance displays **END** after calibration. If the "GLP output (INF0)" parameter of the function table is set to "1" or "2", the balance displays **GLP** and outputs the "calibration report" using the RS-232C interface or stores the data in memory. Refer to "11-2. GLP Report" and "Data memory (dRR)" of the function table for details.
- Step 5 The balance will automatically return to the weighing mode after calibration.

About the internal mass

The value of the internal mass may change due to aging, corrosion or other damage caused by the operating environment. Check the internal mass periodically. Correct the internal mass value as necessary. Refer to "8-6. Correcting the Internal Mass Value".

To maintain the weighing accuracy, perform the calibration using an external weight periodically, as described below.

8-4. Calibration Using an External Weight

This function calibrates the balance using an external weight.

- Step 1 Connect the AC adapter and warm up the balance for at least 30 minutes with nothing on the weighing pan.
- Step 2 Press and hold the **[CAL]** key until **[CAL out]** is displayed, then release the key.
- Step 3 The balance displays **[CAL 0]**.
 - If you want to change the calibration weight, press the **[SAMPLE]** key and go to step 4.
 - If you use the calibration weight value stored in the balance, go to step 5.
- Step 4 Specify the calibration weight value as follows:
 - [SAMPLE]** key... To switch between the calibration weight selection mode (All of the digits blinking) or the value adjustment mode (The selected digits blinking).
The digits up to the 1st decimal place can be adjusted.
 - [RE-ZERO]** key... To select the calibration weight (All of the digits blinking) or adjust the value (The selected digits blinking). Refer to page 18.
 - [PRINT]** key..... To store the new weight value. Even if the AC adapter is removed, the data is maintained in non-volatile memory.
 - [CAL]** key To cancel the operation and return to **[CAL 0]**.
- Step 5 Confirm that there is nothing on the pan and press the **[PRINT]** key. The balance measures the zero point. Do not allow vibration or drafts to affect the balance. The balance displays the calibration weight value.
- Step 6 Place the displayed calibration weight on the pan and press the **[PRINT]** key. The balance measures the calibration weight. Do not allow vibration or drafts to affect the balance.
- Step 7 The balance displays **[End]**.
Remove the weight from the pan.
- Step 8 If the "GLP output (*inFo*)" parameter, of the function table, is set to "i" or "c", the balance displays **[GLP]** and outputs the "Calibration Report" using the RS-232C interface or stores the data in memory. For details on the calibration report format, refer to "11-2. GLP Report".
- Step 9 The balance will automatically return to the weighing mode.
- Step 10 Place the calibration weight on the pan and confirm that the value displayed is within ± 20 digits of the specified value. If it is not within the range, check the ambient conditions such as breeze and vibration, also check the weighing pan. Then, repeat steps 1 to 10.

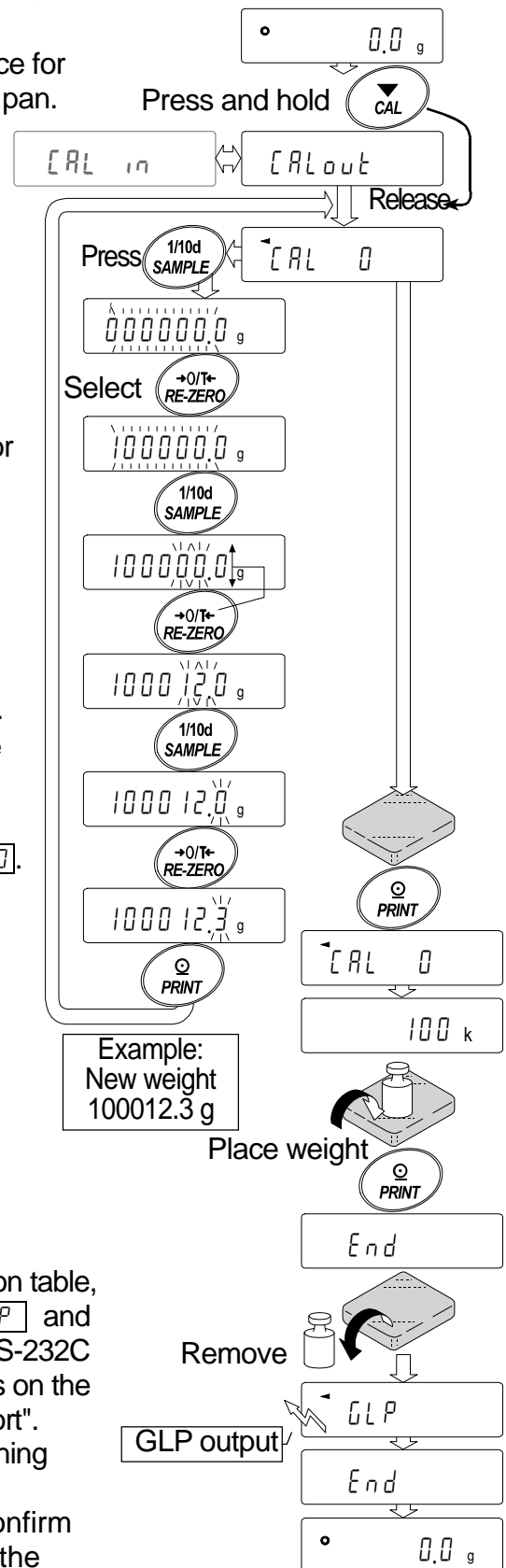

8-5. Calibration Test Using an External Weight

This function tests the weighing accuracy using an external weight and outputs the result. This is available only when the "GLP output (INF0)" parameter is set to "1" or "2". (Calibration test does not perform calibration)

- Step 1 Connect the AC adapter and warm up the balance for at least 30 minutes with nothing on the weighing pan.
- Step 2 Press and hold the **CAL** key until **[[out** is displayed, then release the key.
- Step 3 The balance displays **[[0**.
 - If you want to change the target weight, press the **SAMPLE** key and go to step 4. A list of usable weights is shown on page 18.
 - If you use the target weight value stored in the balance, go to step 5.
- Step 4 Specify the target weight value as follows:
 - SAMPLE** key... To switch between the target weight selection mode (All of the digits blinking) or the value adjustment mode (The selected digits blinking). The digits up to the 1st decimal place can be adjusted.
 - RE-ZERO** key... To select the target weight (All of the digits blinking) or adjust the value (The selected digits blinking). Refer to page 18.
 - PRINT** key..... To store the new weight value. Even if the AC adapter is removed, the data is maintained in non-volatile memory.
 - CAL** key..... To cancel the operation and return to **[[0**.
- Step 5 Confirm that there is nothing on the pan and press the **PRINT** key. The balance measures the zero point and displays the measured value. Do not allow vibration or drafts to affect the balance. The balance displays the target weight value.
- Step 6 Place the displayed target weight on the pan and press the **PRINT** key. The balance measures the target weight and displays the measured value. Do not allow vibration or drafts to affect the balance.
- Step 7 The balance displays **End**. Remove the weight from the pan.
- Step 8 The balance displays **GLP** and outputs the "calibration test report" using the RS-232C interface or stores the calibration test data in memory. Refer to "11-2. GLP Report" of the function table for details.
- Step 9 The balance will automatically return to the weighing mode.

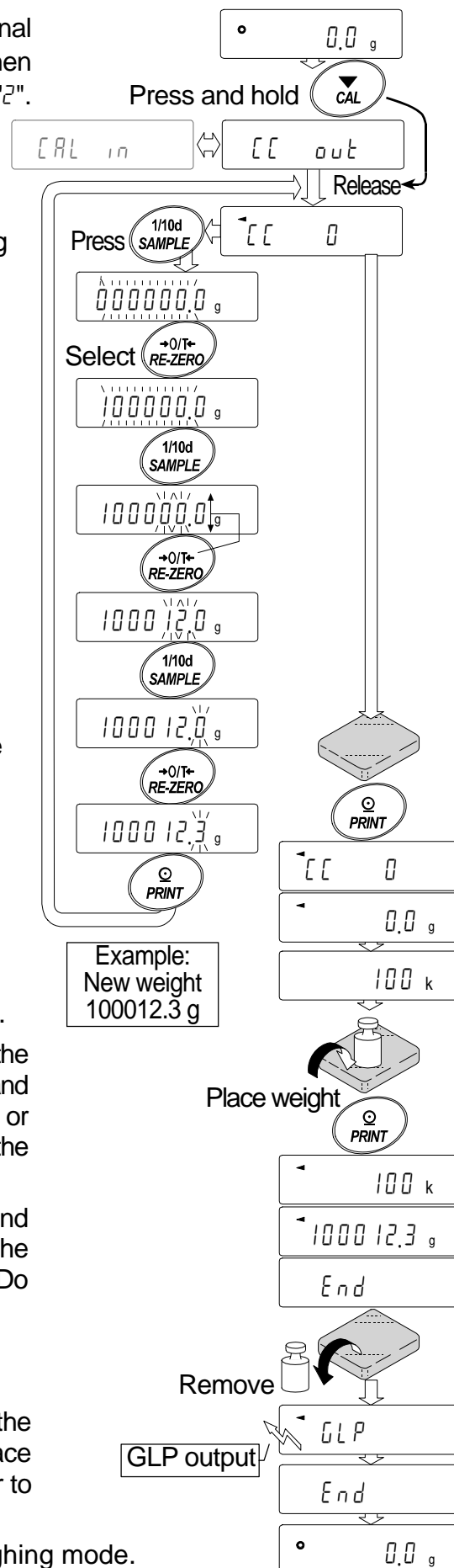

8-6. Correcting the Internal Mass Value

The balance can correct the internal mass value within the range shown below. This function corrects the internal mass value to conform to an external weight. The corrected mass value is maintained in non-volatile memory even if the AC adapter is removed. The internal mass value is corrected as follows:

Model	Target	Range
MC-100KS	100 kg	±50.0 g

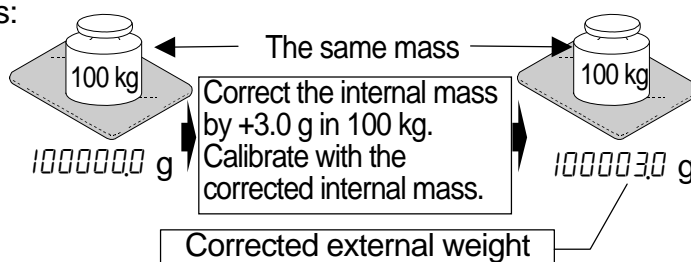

Step 1 Calibrate the balance using the internal mass. (one-touch calibration).

Place the external weight and find out the correction value.

Example for correcting the weight value by +3.0 g in 100 kg:

If correcting the weight value by +3.0 g in 50 kg, the correction value is +6.0 g as the target value is 100 kg.

Step 2 Press the **ON:OFF** key to turn off the display.

Step 3 While pressing and holding the **PRINT** key and the **SAMPLE** key, press the **ON:OFF** key. The balance displays **PS**.

Step 4 Press the **PRINT** key. Then the balance displays the function switches. Set the function table switch and internal mass correction switch to "1" as shown above using the following keys.

SAMPLE key...To select the switch to change the value.

The selected digit blinks.

RE-ZERO key...To change the parameter of the switch selected.

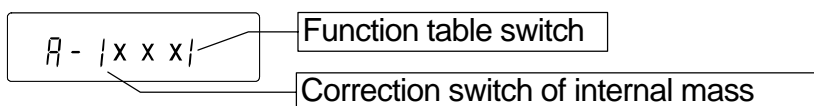

Step 5 Press the **PRINT** key to store the new setting. The balance returns to the weighing mode.

Step 6 Press and hold the **SAMPLE** key to enter the function table and release the key when **bRSFnC** is displayed.

Step 7 Press the **SAMPLE** key several times until **[5 in]** is displayed, then release the key.

Step 8 Press the **PRINT** key to enter the procedure for correcting the internal mass value.

Step 9 Correct the internal mass value using the following keys.

RE-ZERO key...To select the value. (-500 digits appear after +500 digits)

PRINT key.....To store the new value and display the next menu item of the function table.

CAL key.....To cancel the correction and display the next menu item of the function table.

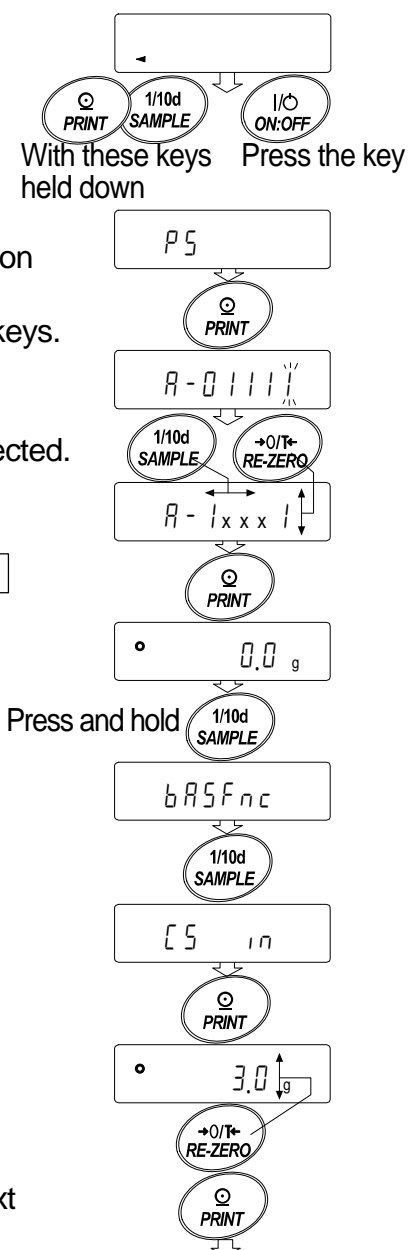

Step 10 Press the **CAL** key to return the weighing mode.

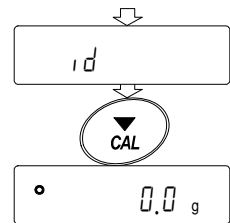

Step 11 Press the **CAL** key to calibrate the balance using the internal mass.

Step 12 Place the external weight on the pan and confirm that the correction has been performed properly. In this example, confirm that the value displayed is within the range that is described at "Accuracy after calibration using the internal mass" of "17. Specifications". If the value is incorrect, repeat the correction.

9. Function Switch And Initialization

9-1. Permit or Inhibit

The balance stores parameters that must not be changed unintentionally (Example: Calibration data for accurate weighing, Data for adapting to the operating environment, Control data for the RS-232C interface). There are five switches for the purpose of protecting parameters. Each switch can select either "permit" or "inhibit". The "inhibit" protects parameters against unintentional operations.

Step 1 Press the **ON:OFF** key to turn off the display.

Step 2 While pressing and holding the **PRINT** key and the **SAMPLE** key, press the **ON:OFF** key to display **P5**.

Step 3 Press the **PRINT** key. Then the balance displays the function switches.

Step 4 Set the switches using the following keys.

- | | |
|--------------------|---|
| SAMPLE key | To select a switch to change the parameter. The selected switch blinks. |
| RE-ZERO key | To change the parameter of the switch selected. |
| | □ To inhibit changes. (Can not be used.) |
| | ! To permit changes. (Can be used.) |
| PRINT key | To store the new parameter and return to the weighing mode. |
| CAL key | To cancel the operation and return to the weighing mode. |

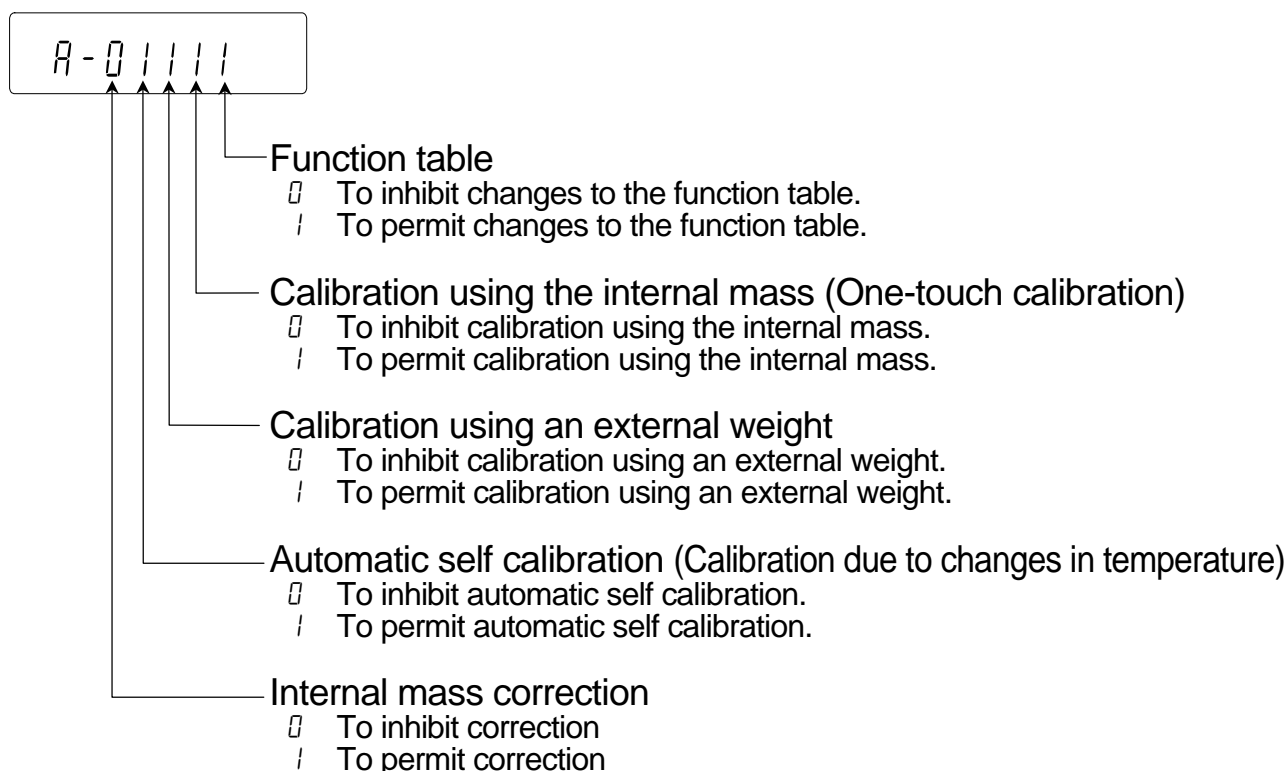

9-2. Initializing the Balance

This function returns the following parameters to factory settings.

- Calibration data
- Function table
- The sample unit mass value (counting mode),
100% reference mass value (percent mode)
- The data that is stored in the balance using the data memory function
- External calibration weight and target weight value
- Function switch settings

Note Be sure to calibrate the balance after initialization.

Step 1 Press the **ON:OFF** key to turn off the display.

Step 2 While pressing and holding the **PRINT** key and the **SAMPLE** key, press the **ON:OFF** key to display **PS**.

Step 3 Press the **SAMPLE** key to display **[Lr]**.

Step 4 Press the **PRINT** key.
To cancel this operation, press the **CAL** key.

Step 5 Press the **RE-ZERO** key to display **[Lr 00]**.

Step 6 Press the **PRINT** key to initialize the balance.
The balance will automatically return to the weighing mode.

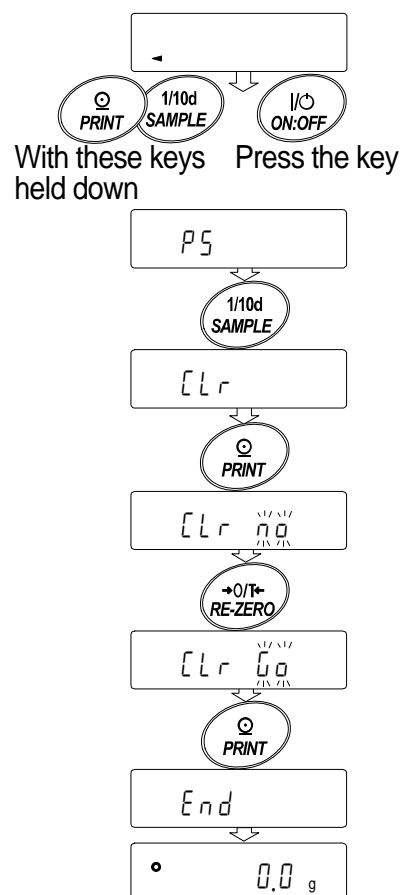

10. Function Table

This function table reads or rewrites the parameters that are stored in the balance. These parameters are maintained in non-volatile memory, even if the AC adapter is removed.

10-1. Sequence of the Function Table

This function table menu consists of two layers. The first layer is the "Class" and the second layer is the "Item". Each item stores a parameter. New parameters are applied to the balance after the **PRINT** key is pressed.

Example

This example sets "Stores weighing data" for "Data memory" and "1 minute" for "Interval time".

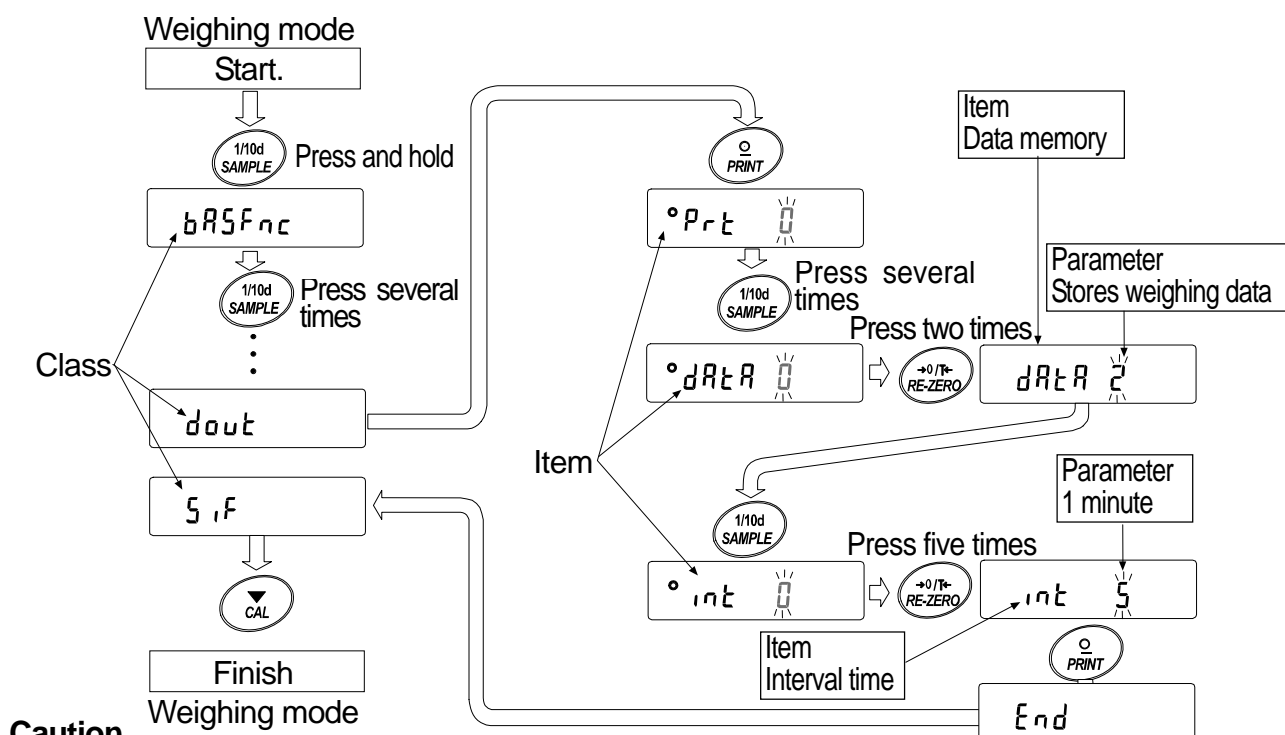

Caution

Check the settings and condition before changing parameters.

10-2. Display and Operation Keys

	The symbol "O" indicates that the parameter displayed is in effect.
	When pressed and held in the weighing mode, enters the function table mode. Selects the class or item in the function table mode.
	Changes the parameter.
	When a class is displayed, moves to an item in the class. When an item is displayed, stores the new parameter and displays the next class.
	When an item is displayed, cancels the new parameter and displays the next class. When a class is displayed, exits the function table mode and returns to the weighing mode.

10-3. Details of the Function Table

Class	Item and Parameter	Description										
bRSFnC Environment Display	Cond Condition	<table border="0"> <tr> <td>0</td> <td>Fast response, sensitive value</td> <td>FAST</td> </tr> <tr> <td>1</td> <td></td> <td>MID</td> </tr> <tr> <td>2</td> <td>Slow response, stable value</td> <td>SLOW</td> </tr> </table>	0	Fast response, sensitive value	FAST	1		MID	2	Slow response, stable value	SLOW	
	0	Fast response, sensitive value	FAST									
	1		MID									
	2	Slow response, stable value	SLOW									
	St-b Stability band width	<table border="0"> <tr> <td>0</td> <td>Stable when within ± 1 digit</td> </tr> <tr> <td>1</td> <td></td> </tr> <tr> <td>2</td> <td>Stable when within ± 3 digits</td> </tr> </table>	0	Stable when within ± 1 digit	1		2	Stable when within ± 3 digits	The stabilization indicator illuminates with the display fluctuation within the range. With "Hold 1", sets the stable range.			
	0	Stable when within ± 1 digit										
	1											
	2	Stable when within ± 3 digits										
	Hold Hold function	<table border="0"> <tr> <td>0</td> <td>OFF</td> </tr> <tr> <td>1</td> <td>ON</td> </tr> </table>	0	OFF	1	ON	Holds the display when stable in animal mode. With "Hold 1", ANIMAL turns on.					
	0	OFF										
	1	ON										
	trc Zero tracking	<table border="0"> <tr> <td>0</td> <td>OFF</td> </tr> <tr> <td>1</td> <td>Normal</td> </tr> <tr> <td>2</td> <td>Strong</td> </tr> <tr> <td>3</td> <td>Very strong</td> </tr> </table>	0	OFF	1	Normal	2	Strong	3	Very strong	Keeps zero display by tracking zero drift.	
	0	OFF										
	1	Normal										
2	Strong											
3	Very strong											
SPd Display refresh rate	<table border="0"> <tr> <td>0</td> <td>Approx. 5 times/second</td> </tr> <tr> <td>1</td> <td>Approx. 10 times/second</td> </tr> </table>	0	Approx. 5 times/second	1	Approx. 10 times/second	Period to refresh the display						
0	Approx. 5 times/second											
1	Approx. 10 times/second											
Pnt Decimal point	<table border="0"> <tr> <td>0</td> <td>Point (.)</td> </tr> <tr> <td>1</td> <td>Comma (,)</td> </tr> </table>	0	Point (.)	1	Comma (,)	Decimal point format						
0	Point (.)											
1	Comma (,)											
P-on Auto display-ON	<table border="0"> <tr> <td>0</td> <td>OFF</td> </tr> <tr> <td>1</td> <td>ON</td> </tr> </table>	0	OFF	1	ON	Turns on the weighing mode display when the AC adapter is connected.						
0	OFF											
1	ON											
P-off Auto display-OFF	<table border="0"> <tr> <td>0</td> <td>OFF</td> </tr> <tr> <td>1</td> <td>ON (10 minutes)</td> </tr> </table>	0	OFF	1	ON (10 minutes)	Turns off the display after 10 minutes of inactivity.						
0	OFF											
1	ON (10 minutes)											
CS1 Capacity indicator	<table border="0"> <tr> <td>0</td> <td>OFF</td> </tr> <tr> <td>1</td> <td>ON</td> </tr> </table>	0	OFF	1	ON	Capacity indicator. Zero: 0% Maximum capacity: 100%						
0	OFF											
1	ON											
Rdd Accumulation function	<table border="0"> <tr> <td>0</td> <td>OFF</td> </tr> <tr> <td>1</td> <td>ON</td> </tr> </table>	0	OFF	1	ON	Displays and outputs the total value of the weighing data.						
0	OFF											
1	ON											
rnG Display at start	<table border="0"> <tr> <td>0</td> <td>Does not display</td> </tr> <tr> <td>1</td> <td>Displays</td> </tr> </table>	0	Does not display	1	Displays	Select whether or not to display the smallest displayable weighing value at weighing start.						
0	Does not display											
1	Displays											
Fl Filter	<table border="0"> <tr> <td>0</td> <td>Not used</td> </tr> <tr> <td>1</td> <td>Used (when the balance is used as a mass comparator)</td> </tr> </table>	0	Not used	1	Used (when the balance is used as a mass comparator)							
0	Not used											
1	Used (when the balance is used as a mass comparator)											
P-tr Zero upon power-on	<table border="0"> <tr> <td>0</td> <td>Sets the display to zero.</td> </tr> <tr> <td>1</td> <td>Does not set the display to zero. Displays the previous value. With this setting, do not perform re-zero operations frequently. Refer to "Zero upon power-on" on page 31.</td> </tr> </table>	0	Sets the display to zero.	1	Does not set the display to zero. Displays the previous value. With this setting, do not perform re-zero operations frequently. Refer to "Zero upon power-on" on page 31.							
0	Sets the display to zero.											
1	Does not set the display to zero. Displays the previous value. With this setting, do not perform re-zero operations frequently. Refer to "Zero upon power-on" on page 31.											
SPn Span calibration	<table border="0"> <tr> <td>0</td> <td>Performs zero and span calibration</td> </tr> <tr> <td>1</td> <td>Performs span calibration only. Span calibration using the internal mass is possible with a tare on the weighing pan. Refer to "Span calibration" on page 31.</td> </tr> </table>	0	Performs zero and span calibration	1	Performs span calibration only. Span calibration using the internal mass is possible with a tare on the weighing pan. Refer to "Span calibration" on page 31.							
0	Performs zero and span calibration											
1	Performs span calibration only. Span calibration using the internal mass is possible with a tare on the weighing pan. Refer to "Span calibration" on page 31.											
CL Rdd Clock	Refer to the GP manual "9-9. Clock and Calendar Function"	Confirms and sets the time and date. The time and date are added to the output data.										
CP FnC Comparator	CP Comparator mode	<table border="0"> <tr> <td>0</td> <td>No comparison</td> </tr> <tr> <td>1</td> <td>Comparison, excluding "near zero" when stable value or overloaded</td> </tr> <tr> <td>2</td> <td>Comparison, including "near zero" when stable value or overloaded</td> </tr> <tr> <td>3</td> <td>Continuous comparison, excluding "near zero"</td> </tr> <tr> <td>4</td> <td>Continuous comparison, including "near zero"</td> </tr> </table>	0	No comparison	1	Comparison, excluding "near zero" when stable value or overloaded	2	Comparison, including "near zero" when stable value or overloaded	3	Continuous comparison, excluding "near zero"	4	Continuous comparison, including "near zero"
	0	No comparison										
	1	Comparison, excluding "near zero" when stable value or overloaded										
2	Comparison, including "near zero" when stable value or overloaded											
3	Continuous comparison, excluding "near zero"											
4	Continuous comparison, including "near zero"											
CP in Data input method	<table border="0"> <tr> <td>0</td> <td>Set the upper lower limit value</td> <td>Select CP H1 or CP L0.</td> </tr> <tr> <td>1</td> <td>Set the reference value</td> <td>Select CP rEF or CP Lnt.</td> </tr> </table>	0	Set the upper lower limit value	Select CP H1 or CP L0.	1	Set the reference value	Select CP rEF or CP Lnt.					
0	Set the upper lower limit value	Select CP H1 or CP L0.										
1	Set the reference value	Select CP rEF or CP Lnt.										
CP-r Comparison results	<table border="0"> <tr> <td>0</td> <td>Not added</td> <td>Select whether or not to add the comparison results to the output data.</td> </tr> <tr> <td>1</td> <td>Added</td> <td></td> </tr> </table>	0	Not added	Select whether or not to add the comparison results to the output data.	1	Added						
0	Not added	Select whether or not to add the comparison results to the output data.										
1	Added											



▪ : Factory settings. Digit is a unit of minimum weighing value.

Class	Item and Parameter	Description	
$[P_{FnC}]$ Comparator Displayed only when Comparator output (GP-04) is installed	$[P_{-b}]$ Main display comparison	0 OFF 1 ON	Displays the results on the main portion of the display in place of the weight value.
	bEP_{-} LO buzzer	0 OFF 1 ON	Select whether or not to sound the LO buzzer.
	bEP_{-} OK buzzer	0 OFF 1 ON	Select whether or not to sound the OK buzzer.
	bEP_{-} HI buzzer	0 OFF 1 ON	Select whether or not to sound the HI buzzer.
$[P_{Hi}]$ Upper limit		Refer to the GP manual "9-10. Comparator Function"	Displayed when $[P_{in0}]$ is selected.
$[P_{Lo}]$ Lower limit			
$[P_{rEF}]$ Reference value		Refer to the GP manual "9-10. Comparator Function"	Displayed when $[P_{in1}]$ is selected.
$[P_{Lnt}]$ Tolerance			
$dout$ Data output	P_{rE} Data output mode	0 Key mode	Accepts the [PRINT] key only when the display is stable.
		1 Auto print mode A (Reference = zero)	Outputs data when the display is stable and conditions of AP_{-P} , AP_{-b} and the reference value are met.
		2 Auto print mode B (Reference = last stable value)	
		3 Stream mode / Interval memory mode	With $dRtR$ 0, outputs data at the specified display refresh rate; with $dRtR$ 2, uses interval memory.
	AP_{-P} Auto print polarity	0 Plus only	Displayed value > Reference
		1 Minus only	Displayed value < Reference
		2 Both	Regardless of displayed value
	AP_{-b} Auto print difference	0 10 digits	Difference between reference value and displayed value
		1 100 digits	
		2 1000 digits	
	$dRtR$ Data memory	0 Not used	Related items: P_{rE} , int , $d-no$, $S-tD$, $info$
		1 Stores unit mass in counting mode	
		2 Stores weighing data	
3 Stores calibration data			
4 Stores comparator settings			
int Interval time	0 Every display refresh	Interval time in the interval memory mode when using P_{rE} 3, $dRtR$ 2	
	1 2 seconds		
	2 5 seconds		
	3 10 seconds		
	4 30 seconds		
	5 1 minute		
	6 2 minute		
	7 5 minute		
8 10 minute			

▪ : Factory settings. Digit is a unit of minimum weighing value.

Class	Item and Parameter	Description			
dout Data output	d-no Data number output	▪ 0	No output	Refer to the GP manual "11. DATA MEMORY"	
		1	Output		
	S-td Time/Date output	▪ 0	No output		Selects whether or not the time or date is added to the weighing data. Refer to the GP manual "9-9. Clock and Calendar Function" for details.
		1	Time only		
		2	Date only		
	S-id ID number output	▪ 0	No output		Selects whether or not the ID number is output.
		1	Output		
	PUSE Data output pause	▪ 0	No pause		Selects the data output interval.
1		Pause (1.6 seconds)			
At-F Auto feed	▪ 0	Not used	Selects whether or not automatic feed is performed.		
	1	Used			
inFo GLP output	▪ 0	No output	Selects the output format for the GLP/GMP compliant report. For how to set time and date to be added, refer to the GP manual "9-9. Clock and Calendar Function".		
	1	AD-8121 format			
Ar-d Zero after output	▪ 0	No output	Adjusts zero automatically after data is output		
	1	Used			
Sif Serial interface	bPS Baud rate	0	600 bps	Refer to "10-6. Description of the Item "Data Format".	
		1	1200 bps		
		▪ 2	2400 bps		
		3	4800 bps		
		4	9600 bps		
	btPr Data bit, parity bit	▪ 0	7 bits, even		
		1	7 bits, odd		
		2	8 bits, none		
	CrLF Terminator	▪ 0	CR LF		CR: ASCII code 0Dh LF: ASCII code 0Ah
		1	CR		
tYPE Data format	▪ 0	A&D standard format			
	1	DP format			
	2	KF format			
	3	MT format			
	4	NU format			
t-UP Timeout	0	No limit	Selects the wait time to receive a command.		
	▪ 1	1 second			
ErCd AK, Error code	▪ 0	No output	AK: ASCII code 06h		
	1	Output			
cts CTS, RTS control	▪ 0	Not used	Controls CTS and RTS.		
	1	Used			
dS Fnc Density function	Ldin Liquid density input	▪ 0	Water temperature	Available only when density mode (15) is selected. Refer to the GP manual "13. DENSITY MEASUREMENT."	
		1	Liquid density		

▪ : Factory settings. Digit is a unit of minimum weighing value.

Class	Item and Parameter	Description	
$\bar{n}L\bar{t}$ Programmable-unit (Multi-unit)		Available only when programmable-unit mode is selected. Refer to the GP manual "12. PROGRAMMABLE-UNIT" for details.	
$U\bar{n}\bar{t}$ Unit		Refer to "5. Weighing Units".	
$\bar{c}S\bar{m}$ Internal mass correction		Displayed only when the internal mass value correction switch is set to 1. Refer to "8. Calibration".	
$i\bar{d}$ ID number setting		Refer to "11. ID Number And GLP Report".	
$E\bar{r}F\bar{n}c$ Extended function	$F1-\bar{b}$ Averaging range for the first moving average	0 Small	
		1 	
		2	
		3	
		▪ 4	
		5 Large	
	$F1-\bar{t}$ Averaging time for the first moving average	0 No averaging	
		1 0.5 second	
		▪ 2 1.0 second	
		3 1.5 seconds	
		4 2.0 seconds	
		5 2.5 seconds	
	Displayed only when "Filter ($F1L$)" is set to "0"	$F2-\bar{b}$ Averaging range for the second moving average	0 Small
			▪ 1 
			2
			3
4			
5 Large			
$F2-\bar{t}$ Averaging time for the second moving average	0 No averaging		
	1 0.5 second		
	2 1.0 second		
	3 1.5 seconds		
	4 2.0 seconds		
	▪ 5 2.5 seconds		
6 3.2 seconds			

▪ : Factory settings. Digit is a unit of minimum weighing value.

Caution

The balance may not transmit the data completely at the specified refresh rate, depending on the baud rate or data added to the weighing data such as time, date and ID number.

10-4. Description of the Class "Environment, Display"

Condition ($Cond$)

$Cond 0$



$Cond 2$

This parameter is for sensitive response to the fluctuation of a weight value. Used for powder target weighing, weighing a very light sample or when quick response weighing is required. After setting, the balance displays **FAST**.

This parameter is for stable weighing with slow response. Used to prevent a weight value from drifting due to vibration or drafts. After setting, the balance displays **SLOW**.

Notes In automatic response adjustment, the weighing speed is selected automatically.

With "Hold function ($Hold$)" set to "ON (1)", this item is used to set the averaging time.

Stability band width ($St-b$)

This item controls the width to regard a weight value as a stable value. When the fluctuation per second is less than the parameter, the balance displays the stabilization indicator and outputs or stores the data. The parameter influences the "Auto print mode"

$St-b 0$



$St-b 2$

This parameter is used for sensitive response of the stabilization indicator. Used for exact weighing.

This parameter ignores slight fluctuation of a weight value. Used to prevent a weight value from drifting due to vibration or drafts.

Note With "Hold function ($Hold$)" set to "ON (1)", this item is used to set the stabilization range.

Zero upon power-on ($P-tr$)

When a hopper is attached to the weighing pan and loss-in weighing is performed, the remaining amount of the material will become unknown if tare is performed each time a weighing starts.

When " $P-tr$ " is set to "1", tare is not performed at weighing start. So, the remaining amount of the material can be monitored, when the power is turned on again after it was turned off.

Span calibration (SP_n)

When a hopper is attached to the weighing pan and calibration is to be performed with the hopper attached, set " SP_n " to "1". When the tare value (hopper and other devices attached) is within the value in the table below, calibration using the internal mass is possible.

Model	Tare value
MC-100KS	99 kg or less

10-5. Description of the Item "Data Output Mode"

The parameter setting of "Data output mode (*Pr_t*)" applies to the performance when the "Data memory (*dRtR*)" parameter is set to "2" (to store the weighing data) and when the data is transmitted using the RS-232C interface.

Key mode

When the PRINT key is pressed with the stabilization indicator turned on, the balance outputs or stores the weighing data and the display blinks one time.

Required setting *dout Prt 0* Key mode

Auto print modes A and B

When the displayed value is stable and the conditions of "Auto print polarity", "Auto print difference" and reference value are met, the balance outputs or stores the weighing data.

When the PRINT key is pressed with the stabilization indicator turned on, the balance outputs or stores the data and the display blinks one time.

Auto print modes A

Example "For weighing each time a sample is added (or removed), with "*Rr-d*" set to "1" (to adjust zero after the data is output)."

Required setting	<i>dout Prt 1</i>	Auto print mode A (reference = zero)
	<i>dout AP-P</i>	Auto print polarity
	<i>dout AP-b</i>	Auto print difference
	<i>dout Rr-d 1</i>	Zero after output

Auto print modes B

Example For weighing while a sample is added.

Required setting	<i>dout Prt 2</i>	Auto print mode B (reference = last stable value)
	<i>dout AP-P</i>	Auto print polarity
	<i>dout AP-b</i>	Auto print difference

Stream mode

The balance outputs the weighing data at the specified display refresh rate, regardless of the display condition. The display does not blink in this mode. The interval memory mode is used when the "Data memory (*dRtR*)" parameter is set to "2" (to store the weighing data).

Example For monitoring data on the AD-8922A remote display.

Required setting	<i>dout Prt 3</i>	Stream mode
	<i>dout dRtR 0</i>	Data memory function is not used
	<i>bRSFnc SPd</i>	Display refresh rate
	<i>SIF bPS</i>	Baud rate

Caution The balance may not transmit the data completely at the specified refresh rate, depending on the baud rate or data added to the weighing data such as time, date and ID number.

Interval memory mode

The weighing data is periodically stored in memory.

Example	For periodical weighing without a personal computer command and to output all of the data, to a computer, at one time.		
	Time and date can be added with "Time/Date output (S-td)".		
Required setting	<i>dout</i> Prt 3	Interval memory mode	
	<i>dout</i> dMtr 2	Data memory function is used	
	<i>dout</i> int	Interval time	
Optional setting	<i>dout</i> S-td 1, 2, or 3	Adds the time and date.	

10-6. Description of the Item "Data Format"

A&D standard format *S IF TYPE 0*

This format is used when the peripheral equipment can receive the A&D format.

If an AD-8121B is used, set the printer to MODE 1 or 2.

- This format consists of fifteen characters excluding the terminator.
- A header of two characters indicates the balance condition.
- The polarity sign is placed before the data with the leading zeros. If the data is zero, the plus sign is applied.
- The unit, consisting of three characters, follows the data.

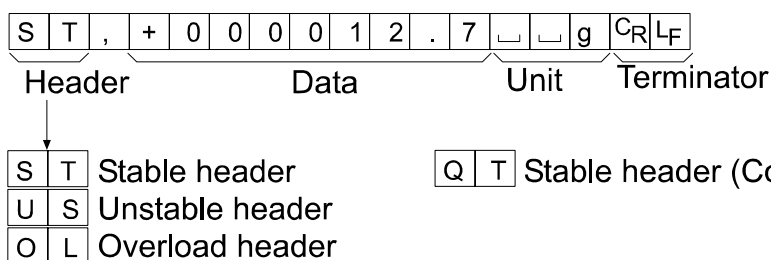

DP (Dump print) format *S IF TYPE 1*

This format is suitable for the peripheral equipment that prints the received data as is.

If an AD-8121B is used, set the printer to MODE 3.

- This format consists of sixteen characters excluding the terminator.
- A header of two characters indicates the balance condition. No overload header is used.
- The polarity sign is placed before the data, with spaces in place of leading zeros, if the data is not zero or overloaded.
- The unit, consisting of three characters, follows the data.

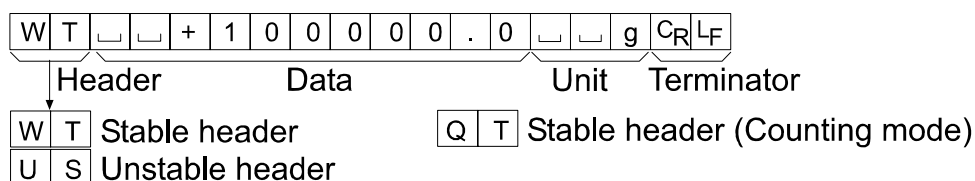

KF format 5 IF TYPE 2

This is the Karl-Fischer moisture meter format and is used when the peripheral equipment can only communicate using this format.

- This format consists of fourteen characters excluding the terminator.
- This format has no header characters.
- The polarity sign is placed before the data, with spaces in place of leading zeros, if the data is not zero or overloaded.
- This format outputs the unit only for a stable value.

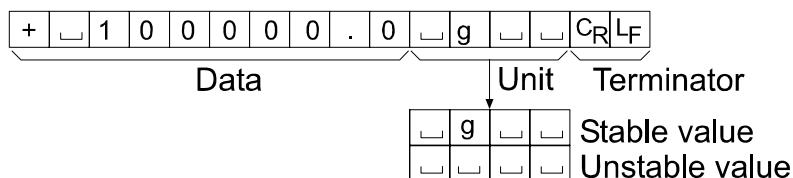

MT format 5 IF TYPE 3

This format is used when the peripheral equipment of other manufacturer is connected. Please note that the connection is not guaranteed.

- A header of two characters indicates the balance condition.
- The polarity sign is used only for negative data.
- The weighing data uses spaces in place of the leading zeros.
- The character length of this format changes dependent upon the unit

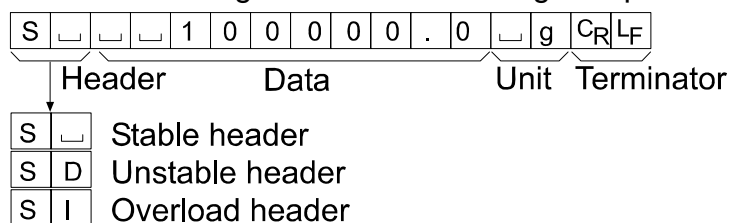

NU (numerical) format 5 IF TYPE 4

This format outputs only numerical data.

- This format consists of nine characters excluding the terminator.
- The polarity sign is placed before the data with the leading zeros. If the data is zero, the plus sign is used.

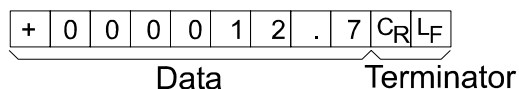

CSV format 5 IF TYPE 5

- This format separates the data of A&D standard format and the unit by a comma (,).
- This format outputs the unit even when the data is overloaded.
- When the ID number, data number, time and date are added at "Data output (*dout*)" of the function table, outputs ID number, data number, date, time and weighing data in this order and separates each item by a comma and treats all the items as one group of data.

LAB-123, No,012, 2012/12/31, 12:34:56, ST,+100000.0, g<CR><LF>

ID number Data number Date Time Weighing data

S	T	,	+	1	0	0	0	0	0	.	0	,			g	C _R	L _F
---	---	---	---	---	---	---	---	---	---	---	---	---	--	--	---	----------------	----------------

O	L	,	+	9	9	9	9	9	9	9	9	E	+	1	9	,			g	C _R	L _F
---	---	---	---	---	---	---	---	---	---	---	---	---	---	---	---	---	--	--	---	----------------	----------------

10-6-1. Description of the Data Format Added to the Weighing Data

ID number *dout 5-id 1*

The number to identify a specific balance.

- This format consists of seven characters excluding the terminator.

L	A	B	-	1	2	3	C _R	L _F
---	---	---	---	---	---	---	----------------	----------------

Data number *dout d-no 1*

This format outputs the data number just before the data is transmitted using the RS-232C interface.

- This format consists of six characters excluding the terminator.
- When CSV format (*5 IF TYPE 5*) is selected, the period (.) is replaced with a comma (,).

N	o	.	0	1	2	C _R	L _F
---	---	---	---	---	---	----------------	----------------

Data number Terminator

Date *dout 5-td 2 or 3*

- The date output order can be changed in "Clock (*EL Add*)".
The year is output in a four-digit format.

2	0	1	2	/	1	2	/	3	1	C _R	L _F
---	---	---	---	---	---	---	---	---	---	----------------	----------------

Time *dout 5-td 1 or 3*

- This format outputs time in 24-hour format.

1	2	:	3	4	:	5	6	C _R	L _F
---	---	---	---	---	---	---	---	----------------	----------------

Tare value

- When the tare value in memory is recalled, the tare value is output before the weighing data.

P	T	,	+	0	0	0	1	2	3	.	4	□	□	g	C _R	L _F
---	---	---	---	---	---	---	---	---	---	---	---	---	---	---	----------------	----------------

 Tare value recalled from memory

N	□	,	+	0	0	0	5	6	7	.	8	□	□	g	C _R	L _F
---	---	---	---	---	---	---	---	---	---	---	---	---	---	---	----------------	----------------

 Net value

Comparison results

- By setting "Comparison results (*CP-r*)" of the function table to "1", the comparison results can be added to the data output using the RS-232C serial interface. Use A&D standard format (*TYPE 0*).

The comparison results are added after the header in A&D standard format as below.

S	T	,	O	K	,	+	0	1	2	3	4	5	.	6	□	□	g	C _R	L _F
---	---	---	---	---	---	---	---	---	---	---	---	---	---	---	---	---	---	----------------	----------------

Header Data Unit Terminator

Comparison result

H	I	When the comparison result is HI
O	K	When the comparison result is OK
L	O	When the comparison result is LO
-	-	Not applicable

Note

When the data described above is added to the weighing data, the output is in the following order: ID number, Data number, Date, Time and Weighing data.

10-7. Data Format Examples

Stable

° 12.7 g

A&D	S	T	,	+	0	0	0	0	1	2	.	7	␣	␣	g	C _R	L _F	
DP	W	T	␣	␣	␣	␣	␣	␣	+	1	2	.	7	␣	␣	g	C _R	L _F
KF	+	␣	␣	␣	␣	␣	1	2	.	7	␣	g	␣	␣	␣	C _R	L _F	
MT	S	␣	␣	␣	␣	␣	␣	␣	1	2	.	7	␣	g	␣	C _R	L _F	
NU	+	0	0	0	0	1	2	.	7	C _R	L _F							

Unstable

- 1836.9 g

A&D	U	S	,	-	0	0	1	8	3	6	.	9	␣	␣	g	C _R	L _F	
DP	U	S	␣	␣	␣	␣	-	1	8	3	6	.	9	␣	␣	g	C _R	L _F
KF	-	␣	␣	␣	1	8	3	6	.	9	␣	␣	␣	␣	␣	C _R	L _F	
MT	S	D	␣	␣	␣	-	1	8	3	6	.	9	␣	g	␣	C _R	L _F	
NU	-	0	0	1	8	3	6	.	9	C _R	L _F							

Overload

Positive error

Ⓔ g

A&D	O	L	,	+	9	9	9	9	9	9	E	+	1	9	C _R	L _F		
DP	␣	␣	␣	␣	␣	␣	␣	␣	␣	␣	␣	␣	␣	␣	␣	C _R	L _F	
KF	␣	␣	␣	␣	␣	␣	H	␣	␣	␣	␣	␣	␣	␣	␣	C _R	L _F	
MT	S	I	+	C _R	L _F													
NU	+	9	9	9	9	9	9	9	9	C _R	L _F							

Overload

Negative error

- Ⓔ g

A&D	O	L	,	-	9	9	9	9	9	9	E	+	1	9	C _R	L _F		
DP	␣	␣	␣	␣	␣	␣	-	E	␣	␣	␣	␣	␣	␣	␣	C _R	L _F	
KF	␣	␣	␣	␣	␣	␣	L	␣	␣	␣	␣	␣	␣	␣	␣	C _R	L _F	
MT	S	I	-	C _R	L _F													
NU	-	9	9	9	9	9	9	9	9	C _R	L _F							

Unit

	Unit	A&D	D.P.	KF	MT
g	g	␣␣g	␣␣g	␣g␣␣	␣g
kg	kg	␣k g	␣k g	␣k g␣	␣k g
Counting mode	pcs	␣P C	␣P C	␣p c s	␣P C S
Precent mode	%	␣␣%	␣␣%	␣%␣␣	␣%
Ounce (Avoir)	oz	␣o z	␣o z	␣o z␣	␣o z
Troy Ounce	oz t	o z t	o z t	␣o z t	␣o z t
Metric Carat	ct	␣c t	␣c t	␣c t␣	␣c t
Momme	mom	m o m	m o m	␣m o m	␣m o
Pennyweight	dwt	d w t	d w t	␣d w t	␣d w t
Tael (HK general, Singapore)	TL	␣t l	␣t l	␣t l s	␣t l
Tael (HK, jewelry)	TL	␣t l	␣t l	␣t l h	␣t l
Tael (Taiwan)	TL	␣t l	␣t l	␣t l t	␣t l
Tael (China)	TL	␣t l	␣t l	␣t l c	␣t l
Tola (India)	t	␣␣t	␣␣t	␣t o l	␣t
Messghal	MS	m e s	m e s	␣M S␣	␣m
Density	DS	␣D S	␣D S	␣D S␣	␣D S
Multi	(Blank)	␣␣␣	␣␣␣	␣␣␣␣	␣

␣ Space, ASCII 20h

L_F Carriage Return, ASCII 0Dh

C_R Line Feed, ASCII 0Ah

11. ID Number And GLP Report

- The ID number is used to identify the balance when Good Laboratory Practice (GLP) or Good Manufacturing Practice (GMP) is used.
- The ID number is maintained in non-volatile memory even if the AC adapter is removed.
- The output format for the GLP/GMP compliant report is selected at "GLP output (*INF0*)" of the function table and can be output to a personal computer or printer using the RS-232C serial interface.
- The GLP/GMP compliant report includes the balance manufacturer, model, serial number, ID number, date, time and space for signature for the weighing data, and the weight used and results for calibration or calibration test data.
- The balance can output the following for the GLP/GMP compliant report.
 - "Calibration report" of the calibration, using the internal mass (Calibration due to changes in temperature and one-touch calibration.)
 - "Calibration report" of the calibration, using an external weight.
 - "Calibration test report" of the calibration test, using an external weight.
 - "Title block" and "End block" for the weighing data.
- Calibration and calibration test data can be stored in memory to output several reports at the same time. Refer to the GP series instruction manual "11. DATA MEMORY" for details.
- For details on confirming and setting the time and date, refer to the GP series instruction manual "9-9. Clock and Calendar Function".

11-1. Setting the ID Number

- Step 1 Press and hold the **SAMPLE** key until **bRSFnC** of the function table is displayed, then release the key.
- Step 2 Press the **SAMPLE** key several times to display **id**.
- Step 3 Press the **PRINT** key. Set the ID number using the following keys.
RE-ZERO key..... To set the character of the digit selected.
 Refer to the display character set shown below.
SAMPLE key, **MODE** key.... To select the digit to change the value.
PRINT key To store the new ID number and display **bRSFnC**.
CAL key..... To cancel the new ID number and display **bRSFnC**.
- Step 4 With **bRSFnC** displayed, press the **CAL** key to return to the weighing mode.

Display character set

0	1	2	3	4	5	6	7	8	9	-	␣	A	B	C	D	E	F	G	H	I	J	K	L	M	N	O	P	Q	R	S	T	U	V	W	X	Y	Z
0	1	2	3	4	5	6	7	8	9	-	␣	A	b	c	d	E	F	G	H	i	J	K	L	M	N	O	P	Q	R	S	T	U	V	W	X	Y	Z

␣ Space

11-2. GLP Report

Set the following parameters to output the GLP/GMP compliant report.

- To print the report, set the "GLP output (*inF_o*)" parameter to "1" and use MODE 3 of the AD-8121B. Refer to "12-2-1. Connection to the AD-8121B Printer" for details on using the printer.
- To output the report to a personal computer using the RS-232C interface, set the "GLP output (*inF_o*)" parameter to "2".
- If the time and date are not correct, set the correct time and date in "Clock (*CL Add*)" of the function table.

Notes

- For operational details about calibration and calibration test, refer to "8. Calibration".

Calibration report using the internal mass

Setting of " *inF_o* 1"

AD-8121 printer format

```

                A & D
MODEL      MC-100K
S/N       01234567
ID        ABCDEFG
DATE      2012/12/31
TIME      12:34:56
CALIBRATED(INT.)
SIGNATURE
-----

```

Setting of " *inF_o* 2"

General format

```

                A_&_D<TERM>
MODEL_____MC - 100K<TERM>
S/N_____01234567<TERM>
ID_____ABCDEFG<TERM>
DATE<TERM>
_____2012/12/31<TERM>
TI ME<TERM>
_____12: 34: 56<TERM>
CALI BRATED(I NT . )<TERM>
SI GNATURE<TERM>
<TERM>
<TERM>
-----<TERM>
<TERM>
<TERM>

```

← Manufacturer →
 ← Model →
 ← Serial number →
 ← ID number →
 ← Date →
 ← Time →
 ← Calibration type →
 ← Signature →

└ Space, ASCII 20h
 <TERM> Terminator, CR , LF or CR
 CR Carriage return, ASCII 0Dh
 LF Line feed, ASCII 0Ah

Calibration report using an external weight

Setting of "inf0 1"

AD-8121 printer format

```

      A & D
MODEL   MC-100K
S/N     01234567
ID      ABCDEFG
DATE    2012/12/31
TIME    12:34:56
CALIBRATED(EXT.)
CAL.WEIGHT
      +100000.0 g
SIGNATURE
-----
  
```

- ␣ Space, ASCII 20h
- <TERM> Terminator, CR , LF or CR
- CR Carriage return, ASCII 0Dh
- LF Line feed, ASCII 0Ah

Setting of "inf0 2"

General format

```

      A_&_D<TERM>
MODEL_____MC-100K<TERM>
S/N_____01234567<TERM>
ID_____ABCDEFG<TERM>
DATE<TERM>
_____2012/12/31<TERM>
TIME<TERM>
_____12:34:56<TERM>
CALI BRATED(EXT. )<TERM>
CAL. WEI GHT<TERM>
____+100000. 0__g<TERM>
SI GNATURE<TERM>
<TERM>
<TERM>
-----<TERM>
<TERM>
<TERM>
  
```

Calibration test report using an external weight

Note Calibration test does not perform calibration.

Setting of "inf0 1"

AD-8121 printer format

```

      A & D
MODEL   MC-100K
S/N     01234567
ID      ABCDEFG
DATE    2012/12/31
TIME    12:34:56
CAL. TEST(EXT.)
ACTUAL
      0.0 g
      +100000.2 g
TARGET
      +100000.0 g
SIGNATURE
-----
  
```

- ␣ Space, ASCII 20h
- <TERM> Terminator, CR , LF or CR
- CR Carriage return, ASCII 0Dh
- LF Line feed, ASCII 0Ah

Setting of "inf0 2"

General format

```

      A_&_D<TERM>
MODEL_____MC-100K<TERM>
S/N_____01234567<TERM>
ID_____ABCDEFG<TERM>
DATE<TERM>
_____2012/12/31<TERM>
TIME<TERM>
_____12:34:56<TERM>
CAL. TEST(EXT. )<TERM>
ACTUAL<TERM>
_____0. 0__g<TERM>
____+100000. 2__g<TERM>
TARGET<TERM>
____+100000. 0__g<TERM>
SI GNATURE<TERM>
<TERM>
<TERM>
-----<TERM>
<TERM>
<TERM>
  
```

Title block and end block

When weight values are recorded as GLP data, a "Title block" is inserted at the beginning and an "End block" is inserted at the end of a group of weight values in the GLP report.

Notes

- To output the report to an AD-8121B , use MODE 3 of the AD-8121B.
- If the data memory function is used, the "Title block" and "End block" can not be output.

Operation

- Step 1 With the weighing data displayed, press and hold the **PRINT** key, until **Start** is displayed, then release the key. The "Title block" is output.
- Step 2 The weighing data is output according to the parameter setting of the data output mode (*PrE*) of the function table.
- Step 3 Press and hold the **PRINT** key until **RecEnd** is displayed, then release the key. The "End block" is output.

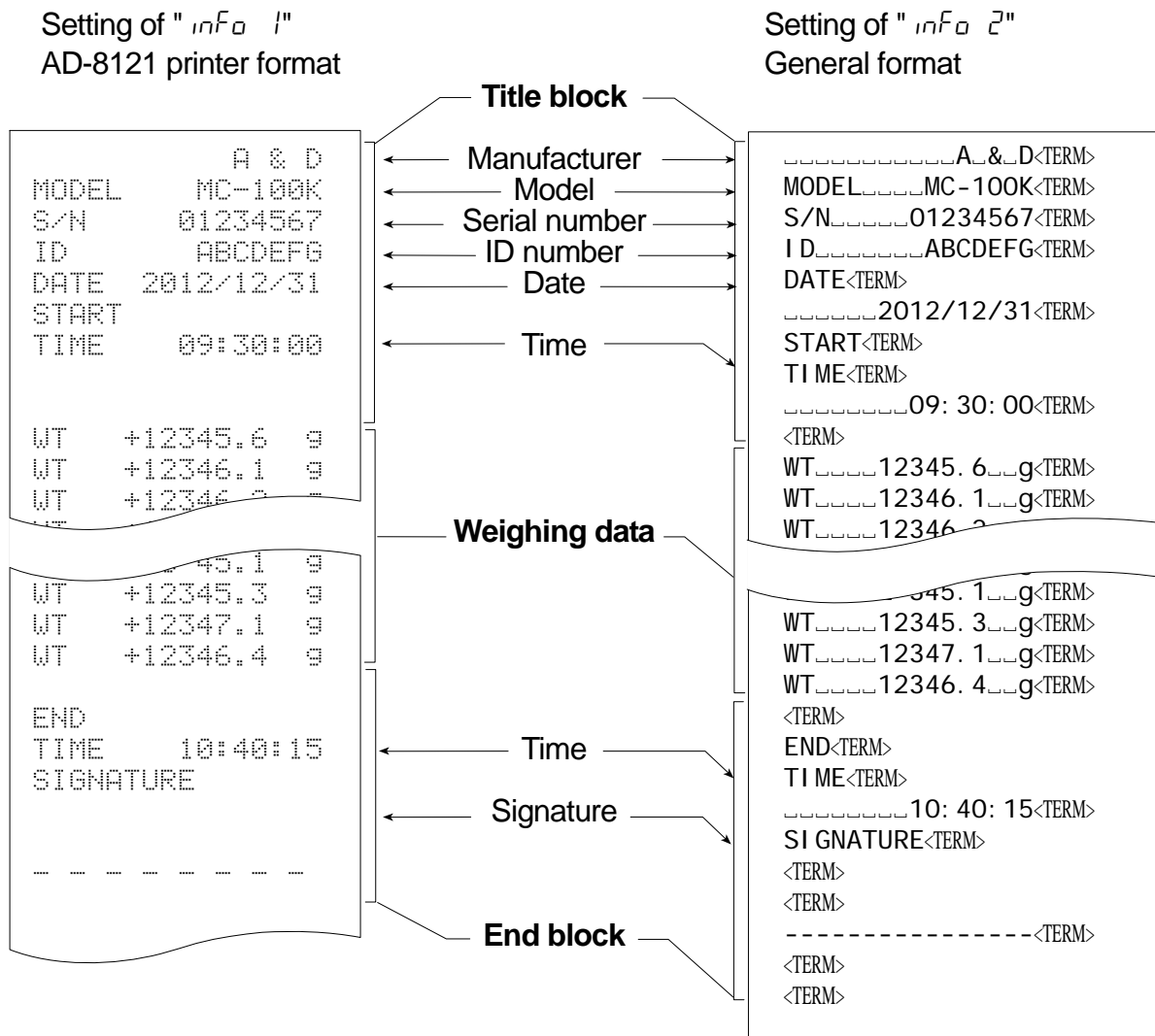

- ┌ Space, ASCII 20h
- <TERM> Terminator, CR , LF or CR
- CR Carriage return, ASCII 0Dh
- LF Line feed, ASCII 0Ah

12. Standard Input And Output Interface

12-1. RS-232C and External Contact Input

D-Sub 25 pin numbers

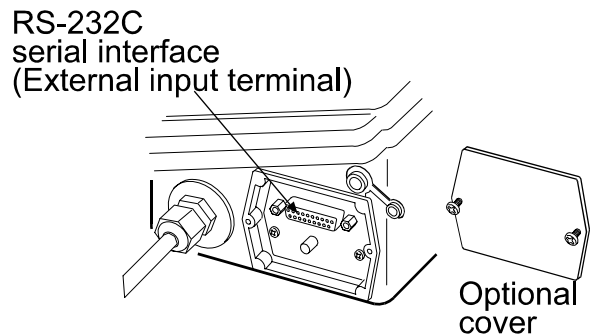
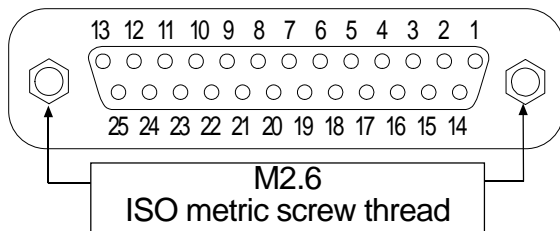

D-Sub 25 pin assignments

Pin No.	Signal name	Interface type	Direction	Description
1	FG		-	Frame ground
2	RXD	RS-232C	Input	Receive data
3	TXD	RS-232C	Output	Transmit data
4	RTS	RS-232C	Input	Ready to send
5	CTS	RS-232C	Output	Clear to send
6	DSR	RS-232C	Output	Data set ready
7	SG	RS-232C / external contact input	-	Signal ground
18	PRINT	External contact input	Input	Same as the PRINT key
19	RE-ZERO	External contact input	Input	Same as the RE-ZERO key
Others	-	-	-	No connection

RS-232C

The balance is a DCE device. Connect the balance to a personal computer (DTE) using a straight through cable.

- Transmission system : EIA RS-232C
- Transmission form : Asynchronous, bi-directional, half duplex
- Transmission rate : 10 times/second or 5 times/second (same as data refresh rate)
- Data format : Baud rate : 600, 1200, 2400, 4800, 9600 bps
- Data bits : 7 or 8 bits
- Parity : Even, Odd (Data bits 7 bits)
None (Data bits 8 bits)
- Stop bit : 1 bit
(When sending, 2 bits; receiving, 1 bit.
A personal computer will function with either setting.)
- Code : ASCII

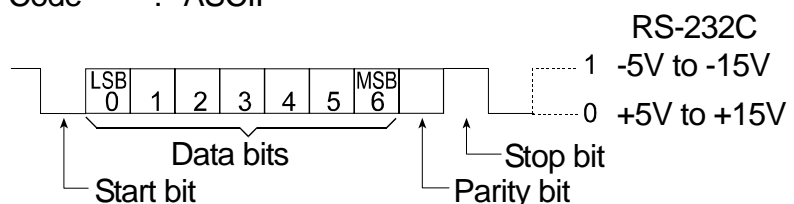

RS-232C Terminals

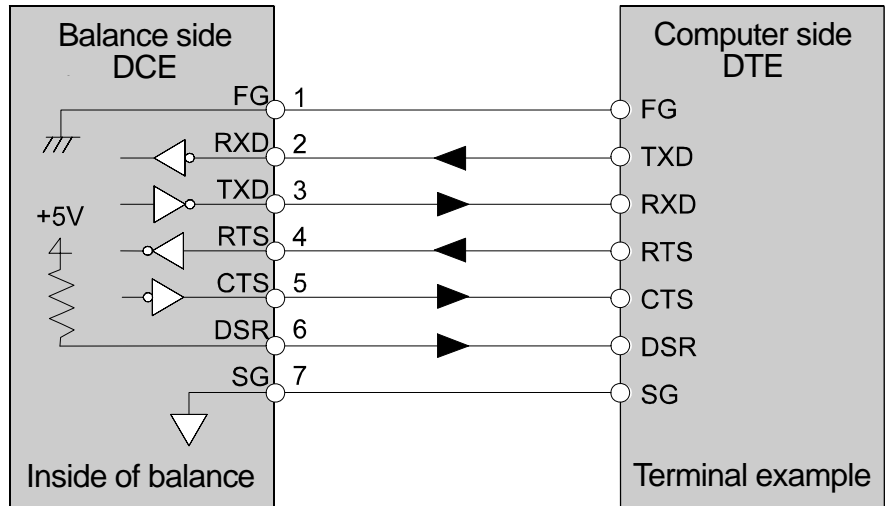

External contact input

By connecting pin 18 (PRINT command) to pin 7, or pin 19 (RE-ZERO command) to pin 7 for 100 ms or more, the same operation as performed by pressing the **PRINT** key or the **RE-ZERO** key, will be performed.

Example use of foot switch

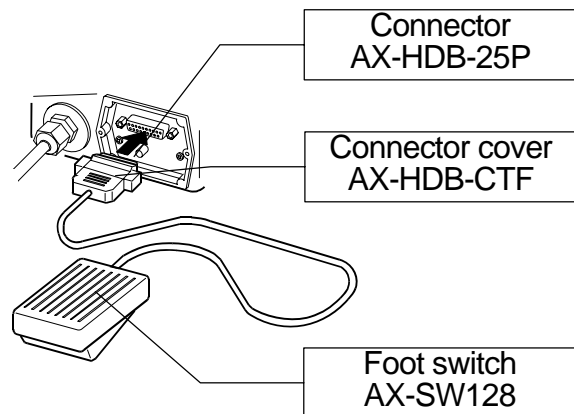

Option

Connector : AX-HDB-25P/CTF
Foot switch : AX-SW128

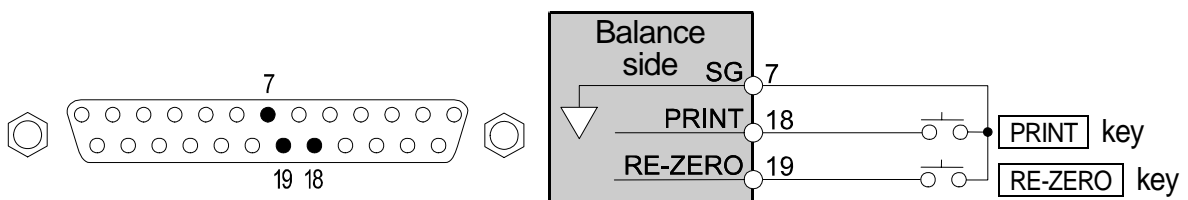

12-2. Connection to Peripheral Equipment

12-2-1. Connection to the AD-8121B Printer

Preset the following parameters to use the AD-8121B printer.

Class	Item and Parameter	Factory settings	AD-8121B MODE 1	AD-8121B MODE 2	AD-8121B MODE 3
Data output	<i>Prt</i> Data output mode	0	0, 1, 2	3	0, 1, 2
	<i>AP-P</i> Auto print polarity	0	#1	Not necessary	#1
	<i>AP-b</i> Auto print difference	0			
	<i>d-no</i> Data number output	0	0	0	0, 1
	<i>S-t-d</i> Time/Date output	0	0	0	0, 1, 2, 3
	<i>S-id</i> ID number output	0	0	0	0, 1
	<i>PUSE</i> Data output pause	0	0	0	0, 1 #2
	<i>At-F</i> Auto feed	0	0	0	0, 1
Serial interface	<i>bPS</i> Baud rate	2	2	2	2
	<i>bLPr</i> Data bit, parity bit	0	0	0	0
	<i>CrLF</i> Terminator	0	0	0	0
	<i>TYPE</i> Data format	0	0	0	1
	<i>cts</i> CTS, RTS control	0	0	0	0

#1 Set parameters when auto print mode A or B (*Prt* 1 or 2) is selected.

#2 Set 1 when multiple lines are printed. Example: When adding ID number, set 1.

Settings of AD-8121B

MODE	AD-8121B DIP switch	Description
MODE 1		Print at receiving data. Standard mode, statistic mode
MODE 2		Print by DATA key operation or built-in timer. Standard mode, interval mode, chart mode
MODE 3		Print at receiving data. Dump print mode

DIP switch No.3 : Handling unstable data

- ON Print
- OFF Not printed

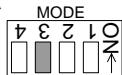

DIP switch No.4 : Data input specifications (Interface selection)

- ON Current loop
- OFF RS-232C

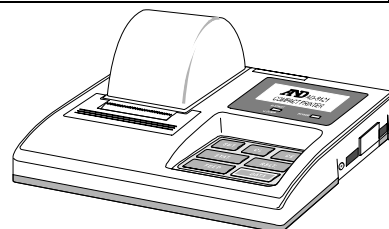
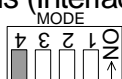

The printer performs as follows, depending on the data memory setting.

Setting	Output data
<i>dRtR</i> 0	The weighing data
<i>dRtR</i> 2	The weighing data stored in memory
<i>dRtR</i> 3	The calibration report stored in memory

Refer to "11-2. GLP Report" for print samples.

12-2-2. Connection to a Computer and the Use of WinCT

The balance is of the DCE type (Data Communication Equipment), which can be connected to a personal computer using the RS-232C interface. Before connection, read the personal computer manual thoroughly. Use a standard DCE cable for connection (cable type: straight-through). When the personal computer type is a DOS/V with a 9-pin port, use a straight-through cable with a 25-pin male connector and a 9-pin female connector.

Using Windows Communication Tools Software (WinCT)

When Windows is used as an operating system in a personal computer, the provided WinCT software can be used to transmit the weighing data to the personal computer.

The WinCT software has two communication methods: "RsCom" and "RsKey". Refer to the WinCT instruction manual.

RsCom

- RsCom can transmit commands to control the balance.
- RsCom can perform bi-directional communication between the balance and a personal computer using the RS-232C interface.
- RsCom can display or store the data using a text file format. RsCom can also print the data using a printer connected to the personal computer.
- When several ports of a personal computer have balances connected, can communicate with each balance simultaneously.
- RsCom can share a personal computer with other application software.
- RsCom can receive the balance GLP report.

RsKey

- RsKey can transmit the weighing data output from the balance directly to other application software such as Microsoft Excel.
- RsKey can be used with most application software.
- RsKey can receive the balance GLP report.

Using the WinCT software, the balance can do the following:

- **Analyzing the weighing data and the statistics with "RsKey"**

The weighing data can be input directly into an Excel worksheet. Then, Excel can analyze the data to obtain total, average, standard deviation, maximum and minimum value, and display them in a graph.
- **Controlling the balance using commands from a personal computer**

By using "RsCom", the personal computer sends commands such as "re-zero" or "send weighing data" to the balance and controls the balance.
- **Printing the balance GLP report using your printer**

The balance GLP report can be printed using a printer connected to the personal computer.
- **Receiving weighing data at a certain interval**

The weighing data can be received at a certain interval and data characteristic with elapsed time can be obtained.
- **Using the balance memory function**

The weighing data can be stored in the balance's memory and can be transmitted to a personal computer at one time.
- **Using a personal computer as an external indicator**

With the "RsKey" test mode function, a personal computer can be used as an external weight indicator for the balance. (To do this, set the balance data output mode to stream mode.)

13. Commands

13-1. Command List

Note A command has a terminator added, that is specified using "S rLF" of the function table, and is sent to the balance.

Commands to query weighing data	
C	Cancels the S or SIR command.
Q	Requests the weighing data immediately.
S	Requests the weighing data when stabilized.
SI	Requests the weighing data immediately.
SIR	Requests the weighing data continuously.

Commands to control the balance	
?CN	Requests the code number of the selected upper/lower limit value.
?HI	Requests the upper limit value.
?ID	Requests the ID number.
?LO	Requests the lower limit value.
?MA	Outputs all weighing data in memory.
?MQnnn	Outputs data with the data number nnn. nnn: Three digits
?MX	Outputs the number of data in memory (the last data number)
?PN	Request the code number of the selected tare value.
?PT	Request the tare value.
?SN	Request the serial number of the balance.
?TN	Request the model name of the balance.
?UN	Requests the code number of the selected unit mass.
?UW	Requests the unit mass value.
CAL	Same as the CAL key.
CN:mm	Recalls the upper/lower limit value in memory. mm: Two digits
HI:*****.*_ _g	Sets the upper limit values. _ is space mark. Example: the upper limit value is 20000.0 g. Command: HI:+020000.0_ _g
ID:*****	Sets the ID number.
LO:*****.*_ _g	Sets the lower limit values. _ is space mark. Example: the lower limit value is 1000.0 g. Command :LO:+001000.0_ _g
MCL	Deletes all data in memory.
MD:nnn	Deletes data with the data number nnn. nnn: Three digits.
OFF	Turns the display off.
ON	Turns the display on.
P	Same as the ON:OFF key
PN:mm	Recalls the tare value in memory. mm: Two digits
PRT	Same as the PRINT key
PT:*****.*_ _g	Sets the tare value. _ is space mark. Example: the tare value is 10000.0 g. Command :PT:+010000.0_ _g

Commands to control the balance	
R	Same as the RE-ZERO key
SMP	Same as the SAMPLE key.
U	Same as the MODE key
UN: mm	Recalls the unit mass values in memory. mm: Two digits
UW: *****.*_ _g	Changes the unit mass value. Unit "g" only. _ is space mark. Example: the unit mass value is 2000.0 g. Command: UW: +002000.0_ _g

When a unit is required in commands such as a "PT:" command, use the 3-digit unit code of the A&D standard format.

nnn indicates a three-digit numerical value.

13-2. Acknowledge Code and Error Codes

When the "Serial interface function (SIF)" parameter is set to "Error 1", the balance outputs <AK> code or error code to each command as follows:

<AK> (06h) Acknowledge in ASCII code.

- When the balance receives a command to request data and can not process it, the balance transmits an error code (EC, E_{xx}).

When the balance receives a command to request data and can process it, the balance outputs the data.

- When the balance receives a command to control the balance and can not process it, the balance transmits an error code (EC, E_{xx}).

When the balance receives a command to control the balance and can process it, the balance transmits the acknowledge code.

Among commands to control the balance, the following transmit the acknowledge code both when the balance receives the command and when the balance has accomplished the command. If the command can not be processed properly, the balance transmits an error code (EC, E_{xx}). This error can be cleared using the CAL command.

CAL command (Calibration command using internal mass)

ON command (Display ON command)

P command (Display ON/OFF command)

R command (RE-ZERO command)

xx is error code number.

R command

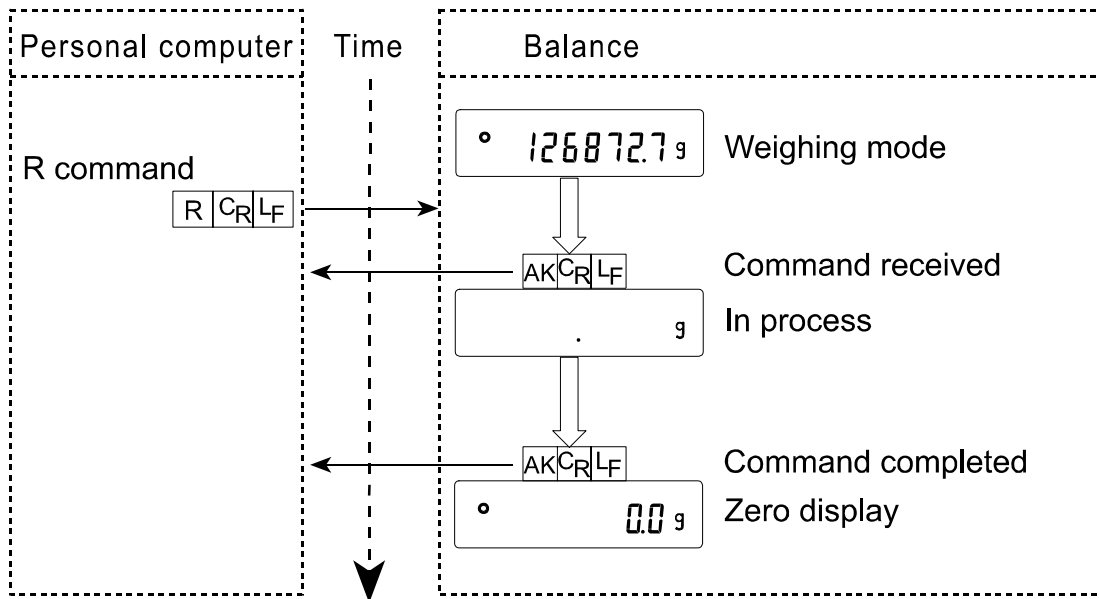

- When a communication error has occurred due to external noise, or a parity error has occurred due to transmission error, the balance transmits an error code. In this case, send the command again.

13-3. Control Using CTS and RTS

Depending on the "[*CTS*]" parameter of "Serial interface (*SIF*)", the balance performs as follows:

[*CTS* 0]

Regardless of whether the balance can receive a command or not, the balance keeps the CTS line Hi. The balance outputs data regardless of the condition of the RTS line.

[*CTS* 1]

The CTS line is kept Hi normally. When the balance can not receive the next command (Example: while the balance is processing the last command), the balance sets the CTS line to Lo. The balance confirms the level of the RTS line before outputting a set of data. If the RTS level is Hi, the balance outputs data. If the RTS level is Lo, data is not output (The data is canceled).

13-4. Settings Related to RS-232C

Concerning the RS-232C, the balance has two functions: "Data output (*dout*)" and "Serial interface (*SIF*)". Set each function as necessary.

14. Extended Function

The MC series balance has several extended functions equipped for special applications or to troubleshoot when using the standard functions.

When the "Filter (*F IL*)" is set to " 0 ", extra items are available as shown below.

Class	Item and Parameter	Description		
<i>E r F n c</i> Extended function	<i>F 1-b</i> Averaging range for the first moving average	0	Small	When the fluctuation of a weight value is within the averaging range, the averaging operation starts to stabilize the displayed value. When the fluctuation of a weight value is small, for example, when weighing or filling a small amount of sample, the averaging is always performed and the response rate maybe slow. Under such a condition, change the parameter. Refer to "Averaging range (<i>F 1-b</i>) and averaging time (<i>F 1-t</i>)"
		1		
		2		
		3		
		▪ 4		
		5		
	<i>F 1-t</i> Averaging time for the first moving average	0	No averaging	When the fluctuation of a weight value is within the averaging range, the averaging operation starts. Once the duration of averaging operations reach the averaging time, moving averaging starts. This parameter sets the time to start moving averaging. Refer to "Averaging range (<i>F 1-b</i>) and averaging time (<i>F 1-t</i>)"
		1	0.5 second	
		▪ 2	1.0 second	
		3	1.5 seconds	
		4	2.0 seconds	
		5	2.5 seconds	
	<i>F 2-b</i> Averaging range for the second moving average	0	Small	Refer to "Filter depending on differences in the amount to deliver powdery and liquid material".
		▪ 1		
		2		
		3		
		4		
	5	Large		
	<i>F 2-t</i> Averaging time for the second moving average	0	No averaging	
		1	0.5 second	
		2	1.0 second	
		3	1.5 seconds	
		4	2.0 seconds	
		▪ 5	2.5 seconds	
6	3.2 seconds			

▪ : Factory settings.

14-1. Description of "Averaging range" and "Averaging time"

14-1-1. Averaging Range ($F I-b$) and Averaging Time ($F I-t$)

1. When the fluctuation of a weight value is beyond the range that is selected in " $F I-b$ ", the averaging operation is disabled and the display reflects the varying value.
2. Once the fluctuation becomes within the selected range, the averaging operation starts to stabilize the weight value.
3. The process of averaging increases. When the selected time is reached, moving averaging will be performed.

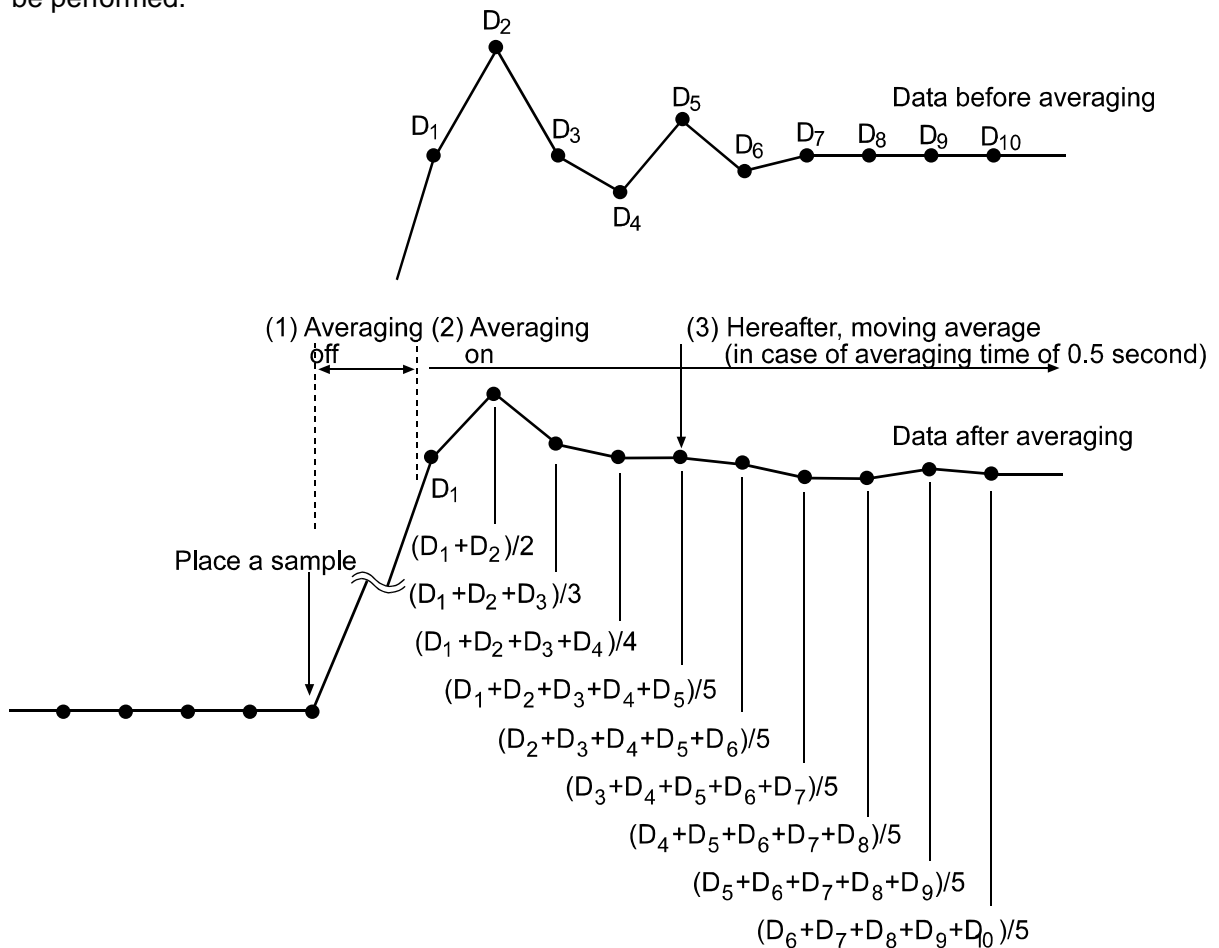

When a small amount of sample is weighed or is filled, the fluctuation of a weight value is too small to be beyond the selected range and the averaging operation is not disabled. Consequently moving averaging is always performed and it takes a longer time to reach the final weight value. Under such a situation, change the setting of " $F I-b$ " to a smaller range. But please note that the smaller the range is, the more prone to external disturbance the value will become.

14-1-2. Filter Depending on Differences in the Amount to Deliver Powdery and Liquid Material

- When the weight value is not stable even without load fluctuations
 - Increase the averaging range for the first moving average parameter ($F1-b$).
 - Increase the averaging time for the first moving average parameter ($F1-t$).
 - Strengthen the digital filter. (Increase the function setting “Condition ($Cond$)” parameter.)

- When response is slow during full and medium flow
 - Decrease the averaging range for the first moving average parameter ($F1-b$).
 - Weaken the digital filter. (Decrease the function setting “Condition ($Cond$)” parameter.)

- When response is slow during dribble flow
 - Decrease the averaging time for the first moving average parameter ($F1-t$).
 - Weaken the digital filter. (Decrease the function setting “Condition ($Cond$)” parameter.)

- To increase stability without load fluctuations
 - Increase the averaging range for the second moving average parameter ($F2-b$).
 - Increase the averaging time for the second moving average parameter ($F2-t$).

15. Maintenance

15-1. Treatment of the Balance

- In normal use, the balance can be cleaned with water. But, keep the following precautions so that dust and water do not invade the balance.
 - Do not direct water pressure at the bottom of the balance.
 - Do not use powerful water jets.
 - Do not submerge the balance in water.
- Clean the balance with a lint free cloth that is moistened with warm water and a mild detergent.
- Do not use organic solvents to clean the balance.
- Do not disassemble the balance. Contact the local A&D dealer if the balance needs service or repair.
- Use the original packing material for transportation.
- While cleaning the balance and keeping it waterproof, attach the optional cover on the RS-232C serial interface terminal and cover the AC adapter jack.

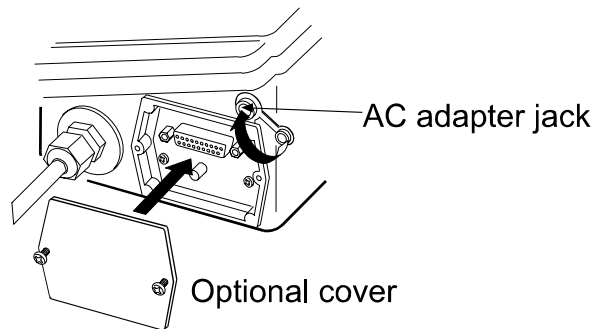

16. Troubleshooting

16-1. Checking the Balance Performance and Environment

The balance is a precision instrument. When the operating environment or the operating method is inadequate, correct weighing can not be performed. Place a sample on the pan and remove it, and repeat this several times. If the balance seems to have a problem with repeatability or to perform improperly, check as described below. If improper performance persists after checking, contact the local A&D dealer for repair.

Checking that the balance performs properly

- Check the balance performance using the self-check function as described in "7. Weighing Speed Adjustment / Self Check Function".
An error display appears when a malfunction is found.
- Check the balance repeatability using an external weight. Be sure to place the weight in the center of the weighing pan.
- Check the balance repeatability, linearity and calibrated value using external weights with a known value.

Checking that the operating environment or weighing method is proper

Operating environment

- Is the weighing table solid enough?
- Is the balance level? Refer to "3-1. Before Use".
- Is the operating environment free from vibration and drafts?
- Is there a strong electrical or magnetic noise source such as a motor near the balance?

Weighing method

- Is the weighing pan installed correctly?
- Is the **RE-ZERO** key pressed before placing a sample on the weighing pan?
- Is the sample placed in the center of the weighing pan?
- Has the balance been calibrated using the internal mass (one-touch calibration)?
- Has the balance been warmed up for 30 minutes before weighing?

Sample and container

- Has the sample absorbed or lost moisture due to the ambient conditions such as temperature and humidity?
- Has the temperature of the container been allowed to equalize to the ambient temperature? Refer to "3-2. During Use".
- Is the sample charged with static electricity? Refer to "3-2. During Use".
- Is the sample of magnetic material such as iron? Caution is required for weighing magnetic materials. Refer to "3-2. During Use".

16-2. Error Codes

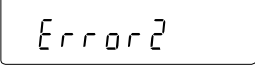
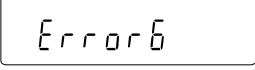
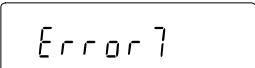
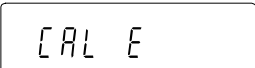
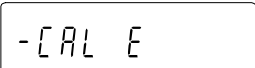
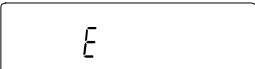
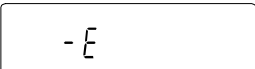
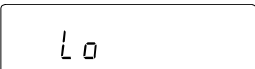
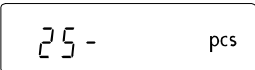
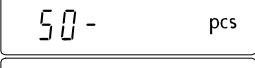
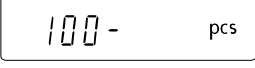
Display	Error code	Description
	EC, E11	Stability error The balance can not stabilize due to an environmental problem. Check around the pan. Refer to "3. Precautions". Prevent vibration, drafts, temperature changes, static electricity and magnetic fields, from influencing the balance. To return to the weighing mode, press the [CAL] key.
		Out of the setting range The data to be stored is out of the setting range.
	EC, E16	Internal mass error Applying the internal mass does not yield a change in the weight value as specified. Confirm that there is nothing on the pan and perform the weighing operation from the beginning again.
	EC, E17	Internal mass error The internal mass application mechanism does not function properly. Perform the weighing operation from the beginning again.
	EC, E20	Calibration weight error The calibration weight is too heavy. Confirm the calibration weight value. Press the [CAL] key to return to the weighing mode.
	EC, E21	Calibration weight error The calibration weight is too light. Confirm the calibration weight value. Press the [CAL] key to return to the weighing mode.
		Overload error A sample beyond the balance weighing capacity has been placed on the pan. Remove the sample from the pan.
		Weighing pan Error The weight value is too light. Confirm that the weighing pan is properly installed. Press the [ON:OFF] key two times to return to the weighing mode. If the error still persists, calibrate the balance.
		Sample mass error The balance can not store the sample for the counting mode or for the percent mode because it is too light. Use a larger sample.
  		Unit mass error The sample unit mass for the counting mode is too light. Storing and using it for counting will cause a counting error. Add samples to reach the specified number and press the [PRINT] key. Pressing the [PRINT] key without adding samples will shift the balance to the counting mode. But, to acquire accurate weighing, be sure to add samples.

Display	Error code	Description
		Automatic response adjustment zero error The automatic response adjustment can not be performed because there is something on the pan. Clear the pan. Press the [CAL] key to return to the weighing mode.
 (Check NG)		Automatic response adjustment unstable error The automatic response adjustment can not be performed because the weight value is unstable. Check the ambient conditions such as breeze, vibration and magnetic fields, also check the weighing pan. Press the [CAL] key to return to the weighing mode.
 (Check no)		Internal error This error indicates an internal error as the result of the self-check function. Repair is required. Contact the local A&D dealer.
		Clock battery error The clock backup battery has been depleted. Press any key and set the time and date. The clock and calendar function works normally as long as the AC adapter is connected to the balance. If this error appears frequently, contact the local A&D dealer.
		Memory full The amount of weighing data in memory has reached the maximum capacity. Delete the data in memory to store new data. For details, refer to the GP manual "11. DATA MEMORY".
		Memory full The amount of calibration or calibration test data in memory has reached the maximum capacity (50 sets). The data in memory will be deleted automatically to store new data. For details, refer to the GP manual "11. DATA MEMORY".
		Memory type error The type of memory set in the function table and the type of data stored are different. For details, refer to the GP manual "11. DATA MEMORY".
	EC, E00	Communications error A protocol error occurred in communications. Confirm the format, baud rate and parity.
	EC, E01	Undefined command error An undefined command was received. Confirm the command.
	EC, E02	Not ready A received command can not be processed. Example: <ul style="list-style-type: none"> □ The balance received a "Q" command, but not in the weighing mode. □ The balance received a "Q" command while processing a RE-ZERO command. Adjust the delay time to transmit a command.

Display	Error code	Description
	EC, E03	Timeout error If the timeout parameter is set to "t-UP l", the balance did not receive the next character of a command within the time limit of one second. Confirm the communication.
	EC, E04	Excess characters error The balance received excessive characters in a command. Confirm the command.
	EC, E06	Format error A command includes incorrect data. Example: □ The data is numerically incorrect. Confirm the command.
	EC, E07	Parameter setting error The received data exceeds the range that the balance can accept. Confirm the parameter range of the command.
Other error code		If an error described above can not be cleared or other errors are displayed, contact the local A&D dealer.

16-3. Other Display



When this indicator blinks, automatic self calibration is required. The indicator blinks when the balance detects changes in ambient temperature. If the balance is not used for several minutes with this indicator blinking, the balance performs automatic self calibration. The blinking period depends on the operating environment.

Advise The balance can be used while this indicator is blinking. We recommend that you perform automatic self calibration for precision weighing.

16-4. Asking for Repair

If the balance needs service or repair, contact your local A&D dealer.

The balance is a precision instrument. Use much care when handling the balance and observe the following when transporting the balance.

- Use the original packing material for transportation.
- Remove the weighing pan from the main unit before placing the balance in the shipping container.

17. Specifications

	MC-100KS
Weighing capacity	101 kg
Maximum display	101084.4 kg
Minimum weighing value (1 digit)	0.1 g
Repeatability *1 (Standard deviation)	0.2 g / 100 kg to 60 kg 0.1 g / less than 60 kg
Linearity*1	±2.4 g
Sensitivity drift, (10°C ~ 30°C / 50°F ~ 86°F, when automatic self calibration is not used)	±6 ppm/°C
Accuracy immediately after calibration using the internal mass *2 (Accuracy of full scale)	±10.0 g
Operating environment	5°C to 40°C (41°F to 104°F) 85%RH or less (No condensation)
Internal mass	Built-in function
Time and clock function	Built-in function
Display refresh rate	Approx. 5 times/second or 10 times/second
Display mode	g (gram)
Interface (Provided as standard)	RS-232C with Windows Communication Tools Software WinCT
External calibration weight	60 kg, 80 kg, 100 kg
Weighing pan	386 x 346 mm
External dimensions	Display: 260(W) x 164(D) x 202(H) mm Main unit: 346(W) x 443(D) x 130(H) mm Cable length: 3 m
Weight	Approx. 18 kg
Power supply (AC adapter)	Power consumption: Approx. 15 VA (supplied to the AC adapter) Confirm that the adapter type is correct for the local voltage and power receptacle type.
Accuracy class M1	20 kg, 50 kg, 100 kg
Dust and water protection	Complying with IP65

*1: When loading and unloading are performed at the same place using the automatic loading machine under good ambient conditions.

*2: Accuracy immediately after calibration using the internal mass under good ambient conditions (within the temperature range of 10°C to 30°C (50°F to 86°F) with no abrupt changes in temperature or humidity, no drafts, no effect by magnetic fields or static electricity).

The value of the internal mass may change due to corrosion or other damage caused by the operating environment, or due to aging. Check the internal mass using an external weight periodically.

17-1. External Dimensions

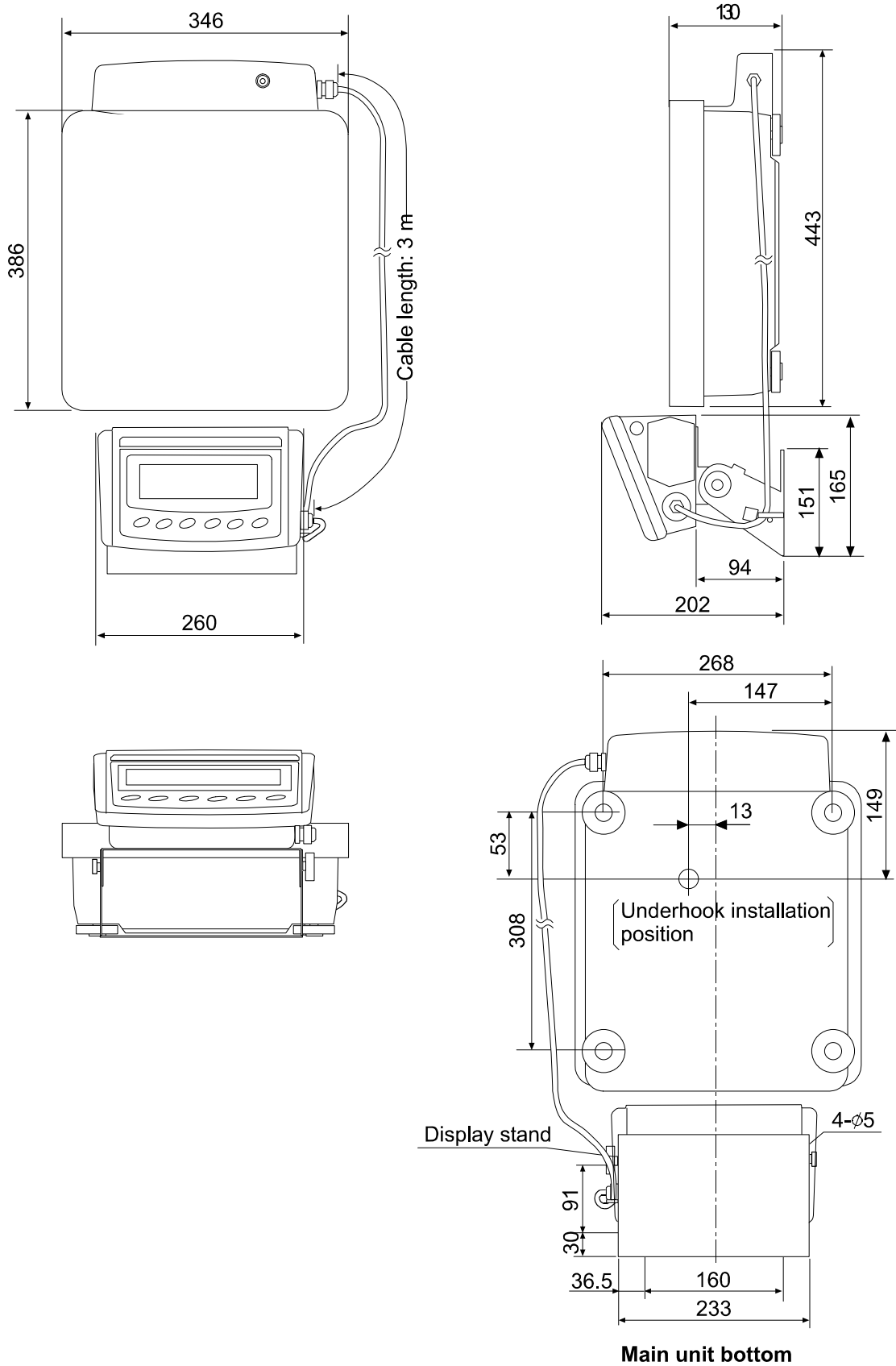

Unit: mm

17-2. Options and Peripheral Instruments

AD-8922A Remote controller

- Connected to the MC series balance using the RS-232C interface to display the weighing data and to remotely control the balance.

AD-8121B Printer

- Compact dot-matrix printer
- Statistical function, clock and calendar function, interval print function, graphic print function, dump print mode
- 5 x 7 dots, 16 characters per line
- Print paper (AX-PP143, 45 (W) x 50 (L) mm , ø65 mm)
- AC adapter or alkaline battery

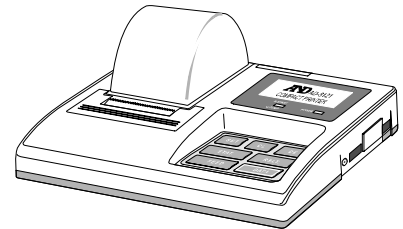

Order code	Name and description
GP-04	<p>Comparator Output (Relay/ with a Buzzer) / RS-232C / Current Loop</p> <ul style="list-style-type: none"> □ This option generates a relay output corresponding to HI , OK and LO in the display. □ Current loop and RS-232C can be used at the same time. For example, a personal computer and an AD-8121B printer can be used simultaneously. □ This option is installed in place of the standard RS-232C serial interface.
GP-06	<p>Analog Voltage Output / Current Loop</p> <ul style="list-style-type: none"> □ This option outputs a voltage of 0 to 1V (or 0.2 to 1V) depending on the displayed value. □ With this option, current loop can be used. For example, an AD-8121B printer can be used simultaneously using this option. □ This option is installed in place of the standard RS-232C serial interface. So, RS-232C is not available for use.
GP-07	<p>Extension Cable, 5 m (Available as factory option only when ordered with an MC-100KS balance)</p> <ul style="list-style-type: none"> □ A cable of 5 meters, to connect between the display and the main unit (The standard cable is 3 meters.)
GP-12	<p>Animal Weighing Bowl</p> <ul style="list-style-type: none"> □ This bowl can be used to weigh a small animal. □ When using this bowl, the weighing range that can be used is an approximately 4 kg less than the weighing capacity.
GP-21	<p>Underhook</p> <ul style="list-style-type: none"> □ Used for measuring the density of magnetic materials and concrete (coarse aggregates).
GP-22	<p>Printer Bracket</p> <ul style="list-style-type: none"> □ Used to place the AD-8121B printer beside the display

Note When option GP-04 or GP-06 is installed in the balance, the balance does not comply with IP-65 (waterproof and dustproof).

Order code	Name and description
AD-1682	<p>Rechargeable Battery</p> <ul style="list-style-type: none"> □ This option allows use of the balance in a place where AC power is not available.
AD-1683	<p>DC Static Eliminator</p> <ul style="list-style-type: none"> □ Used to minimize weighing errors due to static electricity on the material. □ The AD-1683 is direct-current static eliminator. The ions generated produce no breeze and are effective over a long distance. Therefore, the balance can accurately weight powders, etc. by using the AD-1683.
AD-1684	<p>Electrostatic Field Meter</p> <ul style="list-style-type: none"> □ Measures the amount of the static charge on the sample, tare or peripheral equipment and displays the result. If those are found to be charged, discharge them using the AD-1683 DC static eliminator.
AD-1687	<p>Weighing Environment Logger</p> <ul style="list-style-type: none"> □ A data logger equipped with 4 sensors for temperature, humidity, barometric pressure and vibration that can measure and store environmental data. □ When connected to the RS-232C interface of the balance, the AD-1687 can store environmental data along with weighing data. Therefore, it is possible to store data in an environment where a computer can not be used. □ The stored data can be read to a personal computer using USB. As the AD-1687 is recognized as USB memory, special software is not required to read the data.
AD-1688	<p>Data Logger</p> <ul style="list-style-type: none"> □ When connected to the RS-232C interface of the balance, the AD-1688 can store the data in an environment where a personal computer can not be used. □ The stored data can be read to a personal computer using USB. As the AD-1688 is recognized as USB memory, special software is not required to read the data.
AD-8524A/B	<p>Keyboard Adapter</p> <ul style="list-style-type: none"> □ Used to connect the balance to a personal computer with appropriate OS and applications.
AD-8526	<p>LAN Converter</p> <ul style="list-style-type: none"> □ Used to connect the RS-232C interface of the balance to the LAN port of a computer. This allows management of the balance weighing data with a computer connected to a network.
AD-8920A	<p>Remote Display</p> <ul style="list-style-type: none"> □ This option can be connected to the balance using the RS-232C interface.

Order code	Name and description
AX-KO1710-200	RS-232C Cable <ul style="list-style-type: none"> <li data-bbox="469 259 1214 293">□ Length 2 m, straight type, D-sub 9pin - D-sub 25pin.
AX-SW128	Foot Switch <ul style="list-style-type: none"> <li data-bbox="469 360 1434 427">□ This option is used to externally transmit a RE-ZERO or PRINT signal to the balance.
AX-USB-25P	USB Converter <ul style="list-style-type: none"> <li data-bbox="469 483 1434 551">□ Used to connect the RS-232C interface of the balance to the USB port of a computer.

18. Terms/Index

















18-1. Terms

Calibration	Adjustment of the balance so that it can weigh accurately.
Calibration weight	A weight used for calibration
Data number	Numbers assigned sequentially when weighing data or unit weight is stored.
Digit	The minimum weighing value available. Used for the balance, one digit is the smallest mass that can be displayed.
Environment	Ambient conditions such as vibration, drafts, temperature, static electricity and magnetic fields which affect the weighing operation.
External weight	The weight that you have.
GLP	Good Laboratory Practice
GMP	Good Manufacturing Practice
Internal mass	Built-in calibration weight
IP-65	IP code: Degree of protection provided by enclosures. 6: Dust-tight. No ingress of dust. 5: Protect against water jets.
Mode	Balance operational function.
Output	To output the weighing data using the RS-232C interface.
Repeatability	Variation in measured values obtained when the same mass is placed and removed repetitively. Usually expressed as a standard deviation. Example: Standard deviation = 1 digit: This means that measured values, obtained when the same sample is placed and removed repetitively, fall within ± 1 digit in the frequency of about 68%.
Re-zero	To set the display to zero.
Sensitivity drift	An affect that a change in temperature causes to the weighing data. Expressed as a temperature coefficient. Example: Temperature coefficient = 6 ppm/ $^{\circ}$ C : If a load is 100 kg and the temperature changes by 10 $^{\circ}$ C, the value displayed changes by the following value. $0.0006\%/^{\circ}$ C x 10 $^{\circ}$ C x 100 kg = 0.6 g In this example, if the value displayed is 100000.0 g before temperature changes, a temperature change of 10 $^{\circ}$ C will make the value displayed 100000.6 g.

Stable value	The stable weight data, indicated by the illuminated stabilization indicator.
Stabilization time	Time required after a sample being placed, until the stabilization indicator illuminates and the weighing data is displayed.
Store	To save the weighing data, unit mass or calibration data using the data memory function.
Tare	To cancel the weight of a container which is not to be included in the weighing data. Normally, refers to an operation of placing a container and setting the display to zero.
Target weight	An external weight used for calibration test
Zero point	A weighing reference point. Usually refers to the value displayed when nothing is on the weighing pan.

18-2. Index

Keys and symbols

	CAL key	10
	MODE key	10, 13
	ON OFF key	10
	PRINT key	10
	RE-ZERO key	10, 26
	SAMPLE key	10, 26
	Animal indicator	10
	Calibration will start.....	10, 18
	Capacity indicator	10
	Data number	10
	Interval memory mode.....	10
	Process indicator	10, 18
	Space mark.....	38, 39, 40
	Stabilization indicator	10, 26
	Standby indicator	10
	RESPONSE FAST MID SLOW Weighing speed.....	10, 15

- A -

A&D format	33
AC adapter	6
Accessory	59, 60
AD-1682 Rechargeable battery	59
AD-1683 DC static eliminator.....	59
AD-1684 Electrostatic field meter	59
AD-1687 Weighing environment logger.....	59
AD-1688 Data logger	59
AD-8121B Printer	58
AD-8524A/B Keyboard adapter	59
AD-8526 LAN converter.....	59
AD-8920A Remote display	59
AD-8922A Remote controller	13, 58
<i>Add</i> add	27
AK code	46
<i>AP-b</i> Auto print difference	28, 32, 43
<i>AP-d</i> Zero after output	29
<i>AP-P</i> Auto print polarity.....	28, 32, 43
<i>At-F</i> Auto feed.....	29, 43
Averaging range.....	48, 49
averaging time	48, 49
AX-KO1710-200 RS-232C cable	60
AX-SW128 Foot switch.....	42, 60
AX-USB-25P USB converter	60

- B -

<i>bASFnC</i> Environment display	27
<i>bEP1</i> LO buzzer	28
<i>bEP2</i> OK buzzer	28
<i>bEP3</i> HI buzzer.....	28
<i>bPS</i> Baud rate	29, 43
<i>bLPr</i> Data bit, parity bit.....	29, 43

- C -

<i>-CAL E</i> Calibration weight error.....	53
<i>[AL E</i> Calibration weight error.....	53
<i>[AL in</i> One-touch calibration.....	19
<i>[AL out</i> Calibration using an external weight ..	20
<i>[AL</i> Automatic self calibration.....	18
Calibration	17, 21, 61
Calibration test	17
Calibration weight.....	17
<i>[C out</i> Calibration test	21
<i>[H 0</i> Response error	54
<i>[H n0</i> Check NG	16
<i>[H no</i> Check NO	16
<i>[L Add</i> Clock.....	27
<i>[Lr</i> Initializing the balance.....	25
<i>[and</i> Condition.....	13, 27, 31
<i>[P</i> Comparator mode.....	27
<i>[P Fnc</i> Comparator	27
<i>[P Hi</i> Upper limit	28
<i>[P in</i> Data input method.....	27
<i>[P Lnt</i> Tolerance.....	28
<i>[P Lo</i> Lower limit	28
<i>[P rEF</i> Reference value.....	28
<i>[P-b</i> Main display comparison	28
<i>[P-r</i> Comparison results.....	27
<i>[rLF</i> Terminator	29, 43
<i>[S in</i> Internal mass correction.....	30
CSV format	34
<i>[tS</i> CTS, RTS control.....	29, 43
CTS	47

- D -

<i>dAtA</i> Data memory	28
Data number	61
Digit	61
<i>d-no</i> Data number output.....	29
<i>dout</i> Data output.....	28, 32
Dump print	33

- E -

<i>-E</i> Weighing pan Error	53
<i>E</i> Overload error	53
EC,E00 Communications error	54
EC,E01 Undefined command error.....	54
EC,E02 Not ready.....	54
EC,E03 Timeout error.....	55
EC,E04 Excess characters error.....	55
EC,E06 Format error	55
EC,E07 Parameter setting error.....	55
EC,E11 Stability error	53
EC,E16 Internal mass error.....	53
EC,E17 Internal mass error.....	53
EC,E20 Calibration weight error.....	53
EC,E21 Calibration weight error.....	53
<i>ErEd</i> AK, Error code	29

<i>Error 1</i>	Stability error	53
<i>Error 2</i>	Out of the setting range	53
<i>Error 6</i>	Internal mass error.....	53
<i>Error 7</i>	Internal mass error.....	53
Error code		53
Extended function		30, 48
External weight		17, 61

- F -

<i>FIL</i>	Filter	13
FAST	15
<i>FUL</i>	Memory full.....	54

- G -

GP-04	Comparator output/RS-232C/Current loop .	58
GP-06	Analog voltage output/Current loop ...	58
GP-07	Extension cable	58
GP-12	Animal weighing bowl	58
GP-21	Underhook	58
GP-22	Printer bracket.....	58
<i>GS1</i>	Capacity indicator	27

- H -

<i>Hold</i>	Hold function	27
-------------	---------------------	----

- I -

<i>id</i>	ID number setting	30
ID Number	37
<i>info</i>	GLP output.....	29
<i>int</i>	Interval time	28
Internal mass		17
IP-65	7, 58, 61

- K -

KF format	34
-----------	-------	----

- L -

<i>Lo</i>	Sample mass error	53
-----------	-------------------------	----

- M -

Mass comparator		13, 27
MID.	15
<i>MLt</i>	Programmable-unit (Multi-unit)....	30
Mode	61
MT format	34

- N -

Numerical format		34
------------------------	--	----

- O -

Option	58
--------	-------	----

- P -

<i>PS</i>	internal mass correction.....	22
<i>Pnt</i>	Decimal point	27
<i>PoFF</i>	Auto display-OFF	27
<i>P-on</i>	Auto display-ON.....	27
<i>Prt</i>	Data output mode	28, 32, 43
<i>PUSE</i>	Data output pause.....	29, 43

- R -

<i>rEcEnd</i>	End block	40
Repeatability		61
Re-zero	61
<i>rnG</i>	Display at start	27
RsCom	44
RsKey	44
<i>rtc</i>	Clock battery error	54
RTS	47

- S -

<i>S-id</i>	ID number output	29, 43
<i>SIF</i>	Serial interface	29
SLOW	15
Span calibration.....		14, 31
<i>SPd</i>	Display refresh rate.....	27
Stabilization time		62
Stable value		62
<i>StArt</i>	Title block	40
<i>St-b</i>	Stability band width	27, 31
<i>S-tD</i>	Time/Date output	29
Store	62

- T -

Tare	62
Target weight.....		17, 62
<i>trc</i>	Zero tracking	27
<i>t-UP</i>	Timeout	29
<i>tYPE</i>	Data format	29, 43

- U -

<i>Unit</i>	Unit.....	30
-------------	-----------	----

- W -

WinCT	Communication Tools Software ...	44
-------	----------------------------------	----

- Z -

Zero point	62
Zero upon power-on		14, 31



A&D Company, Limited

3-23-14 Higashi-Ikebukuro, Toshima-ku, Tokyo 170-0013, JAPAN
Telephone: [81] (3) 5391-6132 Fax: [81] (3) 5391-6148

A&D ENGINEERING, INC.

1756 Automation Parkway, San Jose, California 95131, U.S.A.
Telephone: [1] (408) 263-5333 Fax: [1] (408)263-0119

A&D INSTRUMENTS LIMITED

Unit 24/26 Blacklands Way, Abingdon Business Park, Abingdon, Oxfordshire OX14 1DY United Kingdom
Telephone: [44] (1235) 550420 Fax: [44] (1235) 550485

A&D AUSTRALASIA PTY LTD

32 Dew Street, Thebarton, South Australia 5031, AUSTRALIA
Telephone: [61] (8) 8301-8100 Fax: [61] (8) 8352-7409

A&D KOREA Limited

한국에이.엔.디(주)
대한민국 서울시 영등포구 여의도동 36-2 맨하탄 빌딩 8층 우편 번호 150-749
(Manhattan Building 8th Floor, 36-2 Yoido-dong, Youngdeungpo-gu, Seoul, 150-749 Korea)
전화: [82] (2) 780-4101 팩스: [82] (2) 782-4280

ООО A&D RUS

ООО "ЭЙ энд ДИ РУС"
121357, Российская Федерация, г.Москва, ул. Вереysкая, дом 17
(Business-Center "Vereyskaya Plaza-2" 121357, Russian Federation, Moscow, Vereyskaya Street 17)
тел.: [7] (495) 937-33-44 факс: [7] (495) 937-55-66

A&D INSTRUMENTS INDIA PRIVATE LIMITED

509, उद्योग विहार , फेस -5, गुडगांव - 122016, हरियाणा , भारत
(509, Udyog Vihar, Phase-V, Gurgaon - 122 016, Haryana, India)
फोन : 91-124-4715555 फैक्स : 91-124-4715599

ऐ&डी इन्स्ट्रुमेन्ट्स इण्डिया प्रा० लिमिटेड