

MA 3Y

Moisture Analyzer

USER MANUAL

IMMU-10-09-11-17-EN



NOVEMBER 2017

Table of contents

1. TECHNICAL SPECIFICATION	7
2. GENERAL SAFETY INFORMATION	8
2.1. Definitions of signals and warning signs	8
2.1.1 Warning descriptions	8
2.1.2 Warning signs.....	8
2.2. Safety information.....	9
2.3. Intended use	10
2.4. Inappropriate use.....	11
2.5. Principles of safety use	11
2.6. Warranty	12
2.7. Monitoring metrological parameters of the instrument.....	12
2.8. Data included in this user manual.....	12
2.9. Staff competence	13
2.9.1. Protective clothing	13
3. TRANSPORT AND STORAGE	14
3.1. Delivery check	14
3.2. Packaging	14
4. UNPACKING, ASSEMBLING AND STARTUP	14
4.1. Assembling and place of use.....	14
4.2. Unpacking.....	15
4.3. Level setting	16
4.4. Standard delivery components	16
4.5. Cleaning	17
4.6. Plugging to mains	17
4.7. Connecting peripheral equipment	17
4.8. Interfaces	17
4.9. Balances with a wireless connection between the terminal and the weighing module (<i>an option</i>).....	18
5. STARTUP	21
5.1. Temperature stabilization period of time.....	22
5.2. Moisture analyzer switching off	22
6. KEYBOARD – FUNCTION KEYS	22
7. SOFTWARE STRUCTURE	24
8. SOFTWARE MAIN WINDOW	25
8.9. Weighing window	25
8.10. Drying window.....	26
8.11. Drying result	27
9. LOGGING	28
10. OPERATING USER MENU	30
10.1. Terminal’s keyboard	30
10.2. Return to weighing mode	31
11. WEIGHING	31
11.1. Selection of measuring unit	31

11.2. Means of correct weighing procedure	32
11.3. Leveling	33
11.4. Zeroing	34
11.5. Tarring	34
11.6. Additional parameters on weighing process.....	35
11.7. Minimum Sample Weight.....	37
11.8. Cooperation with titrators.....	41
12. ADJUSTMENT	42
12.1. External adjustment	42
12.2. User adjustment	43
12.3. Temperature adjustment.....	43
12.5. Adjustment report printout.....	50
12.6. GLP project	50
12.7. Adjustment history	50
13. USERS	52
14. ACCESS LEVEL.....	53
15. PROFILES.....	55
15.1. Creating a profile	55
15.2. Profile structure	56
15.3. Settings.....	57
15.4. Working modes.....	57
15.5. Readout.....	57
15.6. Measuring units	59
16. WORKING MODES – general information	60
16.1. Working mode selection	60
16.2. Parameters related to a working mode	61
16.3. Quick access keys	61
16.3.1. Proximity sensors	62
16.4. Information.....	62
16.5. Printouts.....	63
16.6. Profiles	65
17. DRYING PROCESS – GENERAL INFORMATION	65
SAMPLE PREPARATION FOR DRYING.....	66
17.1.1. Means of moisture content measurement on a moisture analyzer	66
17.1.2. Sampling and preparation.....	66
17.1.3. Sample distribution on drying pan:	68
17.2. SELECTION OF DRYING PARAMETERS	69
17.2.1. Selecting optimum sample mass.....	69
17.2.2. Influence of sample mass on measurement result repeatability	69
17.2.3. Drying temperature	69
17.2.4. Selecting drying mode.....	70
17.2.5. Drying time	71
18. DRYING PROCESS	72
18.1. Working mode activating procedure	72
18.2. Setting drying parameters.....	73
18.2.1. Using fields visible in the main display section	73
18.2.2. Use of menu <Settings>	79
18.2.3. Using database of drying programs	82

18.3. Printouts in drying mode	83
18.4. Report from completed drying process	86
18.5. Means of carrying out drying process	87
18.6. Chart of drying process	92
19. DATABASES.....	94
19.1. Processes carried out on databases	95
19.2. Products	96
19.3. Weighing records	97
19.4. Clients.....	98
19.5. Drying program	99
19.6. Reports from drying process (Drying reports).....	99
19.7. Statistics from drying process reports	101
19.8. Minimal sample weight.....	103
19.9. Ambient conditions.....	104
19.10. Packages	105
19.11. Warehouses	105
19.12. Printouts.....	106
19.13. Universal variables	108
19.14. Database operation	108
19.14.1. Export database of weighing records to file.....	109
19.14.2. Delete database	110
19.14.3. Delete weighments and reports	111
20. COMMUNICATION	113
20.1. RS 232 port settings.....	113
20.2. ETHERNET port settings	113
20.3. WiFi settings	114
20.4. TCP protocol settings	115
21. PERIPHERAL DEVICES	117
21.1. Computer	117
21.2. Printer	118
21.3. Barcode scanners.....	119
21.3.1. Barcode Scanner's Port	120
21.3.2. Prefix/Suffix	120
21.3.2. Field Selection	120
21.3.3 Test	122
21.4. Transponder card scanner	122
21.5. Additional display	123
22. INPUTS / OUTPUTS.....	124
23. OTHER PARAMETERS.....	126
23.1. Interface language	126
23.2. Data and time setting	126
23.3. "Beep" sound	127
23.4. Volume.....	127
23.5. Sleep mode.....	127
23.6. Display brightness.....	127
23.7. Touch screen display calibration	128
23.8. Level control	128
23.9. Drying temperature reducing	129

23.10.	Compatibility with MAC/MAX series.....	129
23.11.	Sensors sensitivity	130
23.12.	Proximity sensors delay	130
23.13.	Autotest	130
23.14.	Start logo	131
23.15.	Export system events	131
24.	UPDATE.....	131
25.	SYSTEM INFORMATION.....	132
26.	MOVIES.....	133
27.	COMMUNICATION PROTOCOL	135
27.1.	A set of commands.....	135
27.2.	Responses format for commands sent from computer level	137
27.3.	Manual printout / Automatic printout	150
28.	CONNECTING PERIPHERAL DEVICES.....	151
29.	DIAGRAMS OF CONNECTING CABLES	151
30.	ERROR MESSAGES.....	152
31.	MOISTURE ANALYZER MAINTENANCE ACTIVITIES	153
31.1.	Cleaning moisture analyzer components.....	153
31.2.	Temperature sensor cleaning	154
31.3.	Replacing the fuses	155
31.4.	Troubleshooting	156
32.	ADDITIONAL EQUIPMENT	157
33.	APPENDIX A – Variables for printouts.....	158
33.1.	List of variables	158
33.2.	Variables formatting	167
34.	APPENDIX E - Settings of ZEBRA printers.....	169
35.	APPENDIX F – Communication with barcode scanners.....	170
36.	APPENDIX G – Menu structure.....	171

1. TECHNICAL SPECIFICATION

Type	MA 60.3Y	MA 200.3Y
Reading unit	0.1 mg	1 mg
Max. capacity	60 g	200 g
Moisture reading accuracy	0,0001%	0,001%
Tare range	- 60 g	- 200 g
Max. sample mass	60 g	200 g
Repeatability of moisture content reading	+/-0,05% (sample ~ 2g), +/-0,01% (sample ~10g)	
Heating module	Halogen Infrared emitter Metal heater	
Drying temperature range	Max 160 °C (infrared emitter or metal heater) Max 250 °C (halogen)	
Drying modes	4 modes: standard, quick, step, mild	
Auto switch off option	4 modes: time-defined, defined, automatic, manual	
Working temperature	+10 °C ÷ +40 °C	
Power supply	230V 50Hz AC / 420W	
Display	Touch screen display	
Drying chamber dimensions	120 x 120 x 20 mm	
Net weight / gross weight	6 / 10 kg	
Packaging dimensions	595 x 395 x 420 mm	

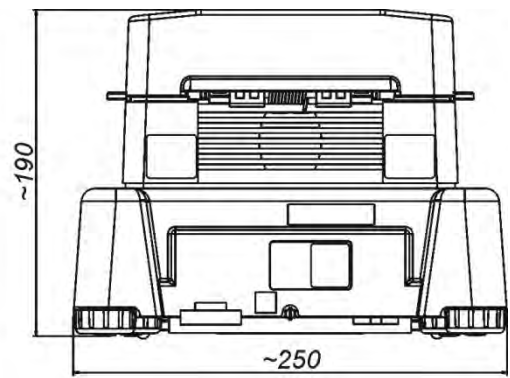
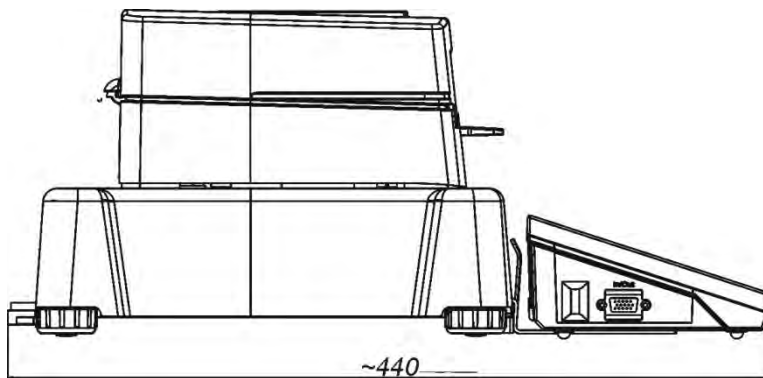

2. GENERAL SAFETY INFORMATION

2.1. Definitions of signals and warning signs

Safety precautions are marked with special descriptions and warning signs. They inform and warn a user of possible dangers. Ignoring the safety warnings may cause injuries, damage of the moisture analyzer, its inappropriate operation and errors of measurements.

2.1.1 Warning descriptions

WARNING	Dangerous situations of high risk. These situations can cause serious injuries or death if the safety precautions are not taken.
CAUTION	Dangerous situations of low risk. These situations can cause damage of the instrument or its functions, loss of data as well as minor or moderate body injuries.
ATTENTION	Important information related to the moisture analyser.

2.1.2 Warning signs



Electric shock risk



Acid / Corrosion



Danger



Flammable or explosive substances



Toxic substances



Hot surfaces

2.2. Safety information

CAUTION!

The use of moisture analyzer MA 3Y regardless of both, safety information and user manual guidelines may cause health damage and even death



WARNING:

Nominal voltage for a moisture analyzer is 230 VAC. It means that safety usage precautions for low voltage devices must be abide by while operating the device.

Three-core power supply cable with grounding pin comes standard with a moisture analyzer.

If necessary, an extension cord can be used as long as it meets the applicable standards and has a protective ground conductor. Intended disconnection of the grounding cable is forbidden.



CAUTION:

Drying chamber cannot be opened during operation (drying process). It is due to the fact that a halogen lamp and its glass shield may reach the temperature of up to 400 C.

When setting up the moisture analyzer leave enough space to prevent heat from building up and to keep your analyzer from overheating. Leave about 20 cm around the instrument and about 1 m above.

Air vents that are located in the housing cannot be covered, sealed or blocked in any other way.

Do not put any flammable substances on, under or near the moisture analyzer.

Be particularly careful when removing the sample from the drying chamber: the sample itself, the drying chamber, shields and the pan can still be extremely hot.

In case of any maintenance work (cleaning the inside of the drying chamber), the moisture analyzer must be switched off.

Wait until all the components have cooled down. Do not perform any modification to the heating module.

Same types of samples require taking particular safety precautions.

They can pose a danger for people and objects. It is always the user who is liable for possible damages caused by the use of an inappropriate sample.



CAUTION:

Corrosion

Substances that release aggressive vapours (e.g. acids) during the heating process. In this case, it is recommended to work with small samples. Otherwise, vapours can condense on cold housing parts and cause corrosion.



WARNING:

Fire or explosion

Flammable or explosive substances, substances containing solvents or releasing flammable or explosive gases or vapours. Perform a risk analysis when in doubt relating to the sample characteristics before carrying out the procedure. For this type of samples apply the drying temperatures as low as possible to prevent flames or explosion. During the analysis it is necessary to wear protective glasses and gloves. The samples should be relatively small.

Under no circumstances can the instrument be left Unsupervised!



WARNING:

Substances containing toxic and caustic or corrosive components

Substances that release toxic gases or vapours can cause irritations (eyes, skin or respiratory system), illnesses or even death. Dry such substances only in fume hood.

Under no circumstances should the instrument be used in an area with any risk of explosion. The moisture analyzer is not designed to operate in hazardous areas.

2.3. Intended use

A moisture analyzer MA 3Y series is designed to determine relative moisture content in small samples of various substances, determine dry mass content in small samples and determine mass of weighed objects.

MA 3Y ensures fast and precise determination process of water content in a tested sample, and application of touch screen display considerably simplifies operation and improves functionality of the moisture analyzer. A moisture analyzer MA 3Y series can be used to determine humidity content of different materials.

At the initial stage of measurement, the device precisely determines the mass of an object placed on instrument's weighing pan. As the mass reading is stabilized, the sample is quickly heated by a halogen lamp, an IR emitter or a metal heater causing humidity evaporation from the tested sample. While sampling, the moisture analyzer is continuously checking the loss of mass, and on calculation, it displays current moisture content in a tested sample. Compared to conventional methods of humidity content determination of various substances, application of moisture analyzer MA 3Y series considerably shortens measurement time and simplifies testing procedure. MA 3Y series allows for setting multiple parameters which influence the procedure of moisture content determination in a sample, such as: temperature, time, drying modes, etc.

2.4. Inappropriate use

CAUTION!

Do not open the drying chamber during drying process. Moisture analyzer features a halogen lamp which is a very powerful heat source. Thus, user should pay special attention not to touch those elements of a moisture analyzer that get hot while drying procedure (i.e.: disposable pan, pan handle, and inner shields of the drying chamber).

Remember that some of tested samples may become dangerous if heated (appearance of poisoning vapours, danger of ignition or explosion).

Moisture analyzer MA 3Y series is not intended for dynamic weighing. Even if small amounts of a sample are added to taken off the weighing pan, the mass readout should only be taken only on stabilization of measurement result (appearance of stability pictogram  on the display).

Do not place any magnetic materials on the weighing pan, as this can cause damage of the measuring system of the instrument. Be sure to avoid impact shock and overloading the moisture analyzer in excess of the prescribed maximum measuring range (max capacity), minus any possible tare weight that has been applied).

Never use the moisture analyzer in an environment endangered by an explosion.

This moisture analyzer is not adjusted for operation in explosive areas. There must not be any modification made to the moisture analyzer.

2.5. Principles of safety use

Moisture analyzer is in accord with all binding safety regulations. Nevertheless there are exceptional circumstances that may cause danger.

It is forbidden to open an instrument housing. Inside there are no parts that would require maintenance, repair or replacement carried out by a user. In

case of any problems it is recommended to contact RADWAG service or a distributor. It must be always remembered to use the device in accordance with this service manual and especially to follow instructions on installation and configuration of a new device.

Use of a moisture analyzer MA 3Y series conversely to safety principles and user manual guidelines may be hazardous to operator's health and life. It is obligatory to acknowledge the safety principles listed in the user manual:

- use a moisture analyzer only to determine humidity content in samples and determine mass of a tested sample. Any other use of the moisture analyzer may be dangerous both to the device and the user,
- before commissioning the moisture analyzer, make sure that the nominal power of the device specified on its data plate, is compatible with the supply in the mains to which the moisture analyzer will be plugged in,
- **change of halogen lamps can only be carried out by authorized service,**
- protect moisture analyzer against contacts with liquids, it might lead to electrocution, fire, emission of substances containing toxic or caustic vapour, emission of explosive substances.

2.6. Warranty

Warranty does not cover the following cases:

- Not observing the regulation listed in user manual,
- Using the moisture analyzer conversely to its intended use,
- Any modifications of moisture analyzer or cases when its housing is opened (damaged protective stickers),
- Mechanical defects and defects caused by media, liquids, water and natural wearing off,
- Improper placing of defects of electrical network / mains,
- Overloading of measuring mechanism of the moisture analyzer.

2.7. Monitoring metrological parameters of the instrument

Metrological characteristics of the moisture analyzer requires periodical inspection carried out by its operator. Inspection frequency is conditioned by ambient conditions in which the moisture analyzer is used, types of performed processes and accepted quality management system in an organization.

2.8. Data included in this user manual

Please read the user manual carefully before instrument's plugging to mains and startup, even if the user is experienced with this type of moisture analyzers.

2.9. Staff competence

Moisture analyzer MA 3Y series should only be operated and maintained by personnel who is trained and experienced in using this type of instruments. In order to use the moisture analyzer, first read the user manual. Keep these instructions for the future reference.

Do not make any structural modifications. Additional equipment, which can be connected to the moisture analyzer, should be supplied by RADWAG or an authorized distributor.

2.9.1. Protective clothing

The use of protective clothing is highly recommended while working with the instrument in order to take safety precautions against potential hazards resulting from tested samples and ingredients.

Use the following while carrying out tests:

- protective apron,
- protective glasses,
- protective gloves (while working with hazardous chemical substances).

Before the use of the above-mentioned protective clothing, make sure that they are designed to be used with specific samples and they are not damaged.

3. TRANSPORT AND STORAGE

3.1. Delivery check

Please check the packaging immediately upon delivery and check instrument's condition directly upon unpacking for any visible signs of external damage.

3.2. Packaging

Please retain all parts of the original packaging should the moisture analyzer be transported in the future. Only the original packaging should be used for dispatching the moisture analyzer. Before packing, disconnect all attached cables and remove any loose/movable parts (weighing pan, shields, inserts). Place moisture analyzer and its components in their original packaging, and protect them against damage during transport.

4. UNPACKING, ASSEMBLING AND STARTUP

4.1. Assembling and place of use

- A moisture analyzer should be stored and used in locations free of vibrations and shakes, free of air movement and dust, located at the max altitude of 2000 above sea level,
- Moisture analyzer's place of use should ensure good air circulation around the instrument (approximately 20 cm free space around the moisture analyzer and 1 m free space over it),
- Ambient air temperature in the weighing room should not exceed the range of:
+10 °C ÷ +40 °C,
- Ambient relative humidity should not exceed 80% in the temperature up to 31°C, and decrease linearly to 50 % of relative humidity in temperature 40°C,
- A moisture analyzer should be located on a stable wall console desk or a stable working table which is not affected by vibrations and distant from heat sources,
- Take special safety measures when weighing magnetic objects, as part of the balance is a strong magnet.

4.2. Unpacking

Carefully remove the moisture analyzer from its packaging, remove the plastic and foil transport protective elements. Gently place the moisture analyzer in its intended place of use.

Assemble the components of drying chamber, following guidelines from below figure:

Assembling moisture analyzer components:

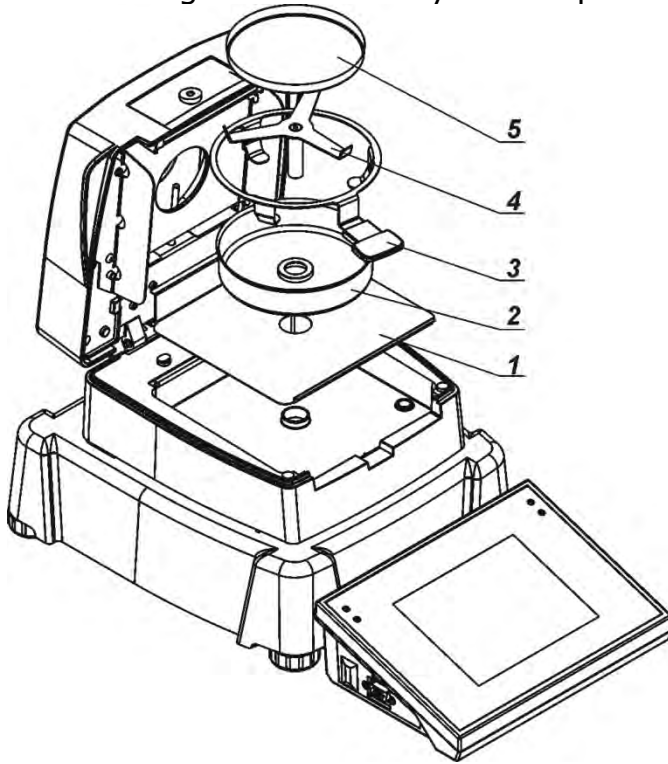

1. Assembly drying chamber base insert
2. Assembly drying pan shield,
3. Assembly drying pan handle,
4. Assembly cross-shaped holder,
5. Assembly the disposable pan.

Setting drying pan's supporter (cross-shaped holder).

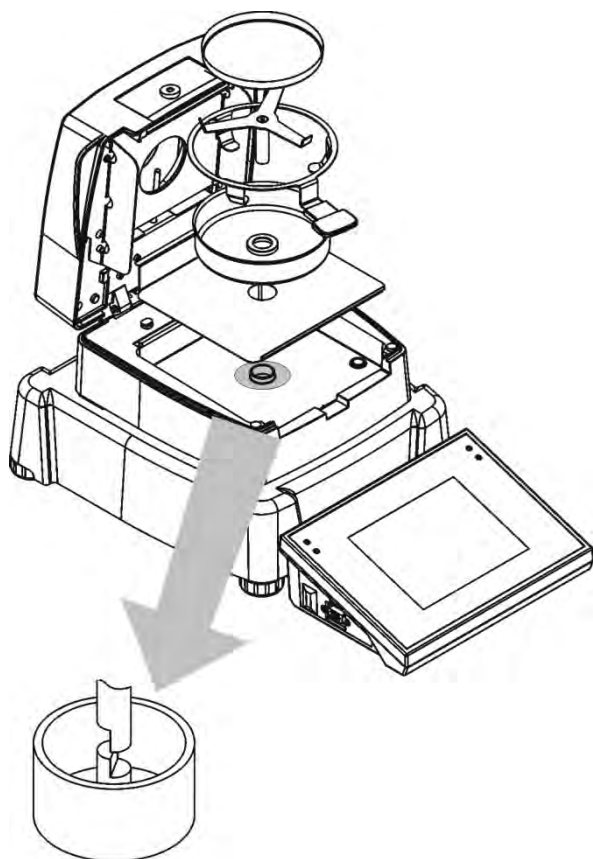

When assembling the pan supporter (cross-shaped holder) pay special attention to the correct positioning of its mandrel. The mandrel features a cut for its unique positioning against the pan handle, thus preventing their contact and friction.

Setting cross-shaped holder:

- On assembling the pan holder onto the mandrel, turn the holder slightly, so that the cut on the mandrel is located in its unique and correct position,
- When turning the mandrel use most gentle movements not to damage moisture analyzer's measuring system.

4.3. Level setting

The moisture analyzer MA 3Y series features an electronic level control system (and thus no external level). After software startup enter the leveling application and follow moisture analyzer prompts to carry out the leveling procedure.

Means of moisture analyzer leveling is described further in this user manual (see point 11.3).

4.4. Standard delivery components

- A moisture analyzer MA 3Y series.
- Insert of drying chamber basis.
- Drying chamber shield.
- Drying pan handle.
- Drying pan cross-shaped holder.
- Disposable pan.
- Power cord.
- Protective cover
- Cable P0108 for connecting moisture analyzer and computer
- User manual (CD).

4.5. Cleaning

Remember to unplug the moisture analyzer from mains before any cleaning activities.

Clean the moisture analyzer using a damp cloth by gentle rubbing contaminated places.

Remember to remove the drying pan from the drying chamber before its cleaning. Cleaning the drying pan assembly while installed may damage instrument's measuring system, thus remove it from the cross-shaped holder.

4.6. Plugging to mains

A moisture analyzer can be plugged to mains only by means of original power cord, which comes standard with the moisture analyzer. Rated voltage (specified on device's data plate) must be compatible with mains rated voltage.

The power cord can be connected only to a socket with ground contact. Plug the power cord to the moisture analyzer. The moisture analyzer's power plug is located at the back of its housing.

4.7. Connecting peripheral equipment

The moisture analyzer must be unplugged from the mains before connecting or disconnecting any peripheral equipment (printer, PC computer). Use only peripheral equipment recommended by the manufacturer with your moisture analyzer. These have been ideally coordinated to your moisture analyzer. On connecting a peripheral device, plug the moisture analyzer to mains.

4.8. Interfaces

Description of terminal's interfaces

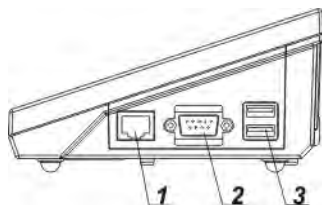

- 1 – Ethernet RJ45
- 2 – RS232 (COM1)
- 3 – USB port

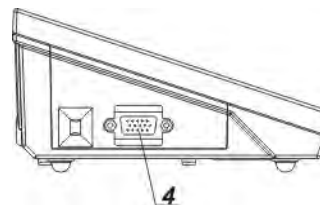

- 4 – IN/OUT, RS232 (COM2)

Interface RS232 and IN/OUT



RS232 - socket DB9/M (male), front view:

- Pin2 - RxD
- Pin3 - TxD
- Pin5 - GND

IN/OUT, RS232 socket DSUB15/F (female), front view:

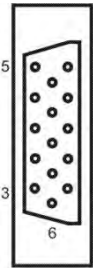

- Pin1 - GNDWE
- Pin2 - OUT1
- Pin3 - OUT2
- Pin4 - COMM
- Pin5 - 6÷9VDC
- Pin6 - IN4
- Pin7 - IN3
- Pin8 - TxD2
- Pin9 - 5VDC
- Pin10 - GNDRS
- Pin11 - IN2
- Pin12 - IN1
- Pin13 - RxD2
- Pin14 - OUT4
- Pin15 - OUT3

4.9. Balances with a wireless connection between the terminal and the weighing module

(an option)



The terminal operates on batteries, wireless connection ensures its cooperation with the weighing module. This, in contrast to a standard design, allows to eliminate cable connecting the devices.

Wireless connection solution is marked by letter , eg. **MA 50.3Y.B.**

Features:

Maksimum range: 10 m

Maxumum operation time of the terminal (without the necessity to charge baterries): 8 h

Usage:

1. Lack of additional sources of vibration

Terminal located elsewhere than the weighing bench eliminates vibrations being a result of operation. This ensures stable working conditions for balances with the highest. No specific weighing benches are needed.

2. Comfort of weighing in fume cupboards and laminar flow cabinets

Wireless connection between a terminal and a weighing module positively influences weighing process making it more comfortable and safer.

3. Elimination of unfavourable influence factors

Due to wireless connection the weighing module may be completely separated from the operator by being placed in an anti-draft chamber. This makes weighing of contaminated and toxic substances possible without putting one's health and life to risk.

4. Improved pipetting ergonomics

Pipettes calibration process requires precision and quickness of operation. Wireless connection redefines comfort of operation which will definitely be appreciated by the user.

Wireless solutions are equipped with 2 power suppliers. One used for supplying the weighing module, the other for powering the terminal.

Start-up procedure

On unpacking and placing the balance onto its workstation it is necessary to connect the weighing module and the terminal to mains. Next the user shall proceed like in case of a standard design (description to be found further down this manual).

Main window preview for a wireless connection solution is presented below.

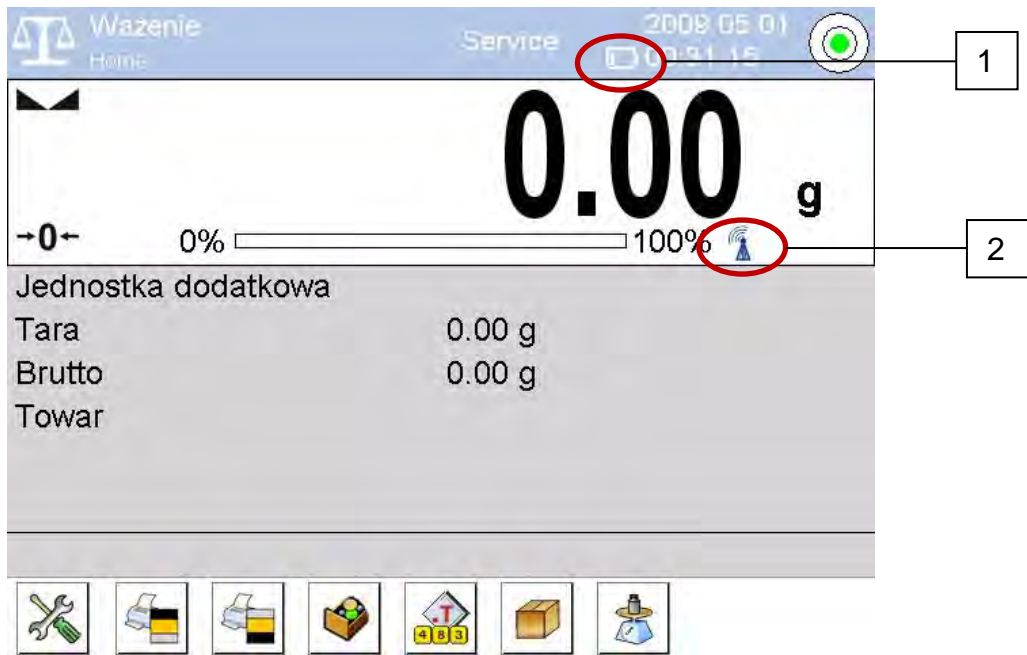

Main window of a wireless connection solution features two extra icons when compared to a standard design:

1. battery charge status icon
2. wireless connection icon

Operation and functions are identical like for standard design balances.

Icons description

Battery charge status icon:

No.	Icon	Description
1		Battery charging
2		Battery charged, terminal connected to mains
3		Battery charged, terminal not connected to mains
4		Battery status (about 50%), terminal not connected to mains
5		Minimal battery status, necessity of connecting the terminal to mains

Wireless connection icon:

No.	Icon	Description
1		Correct connection of wireless modules – correct cooperation
2		Connection interrupted – loss of connection

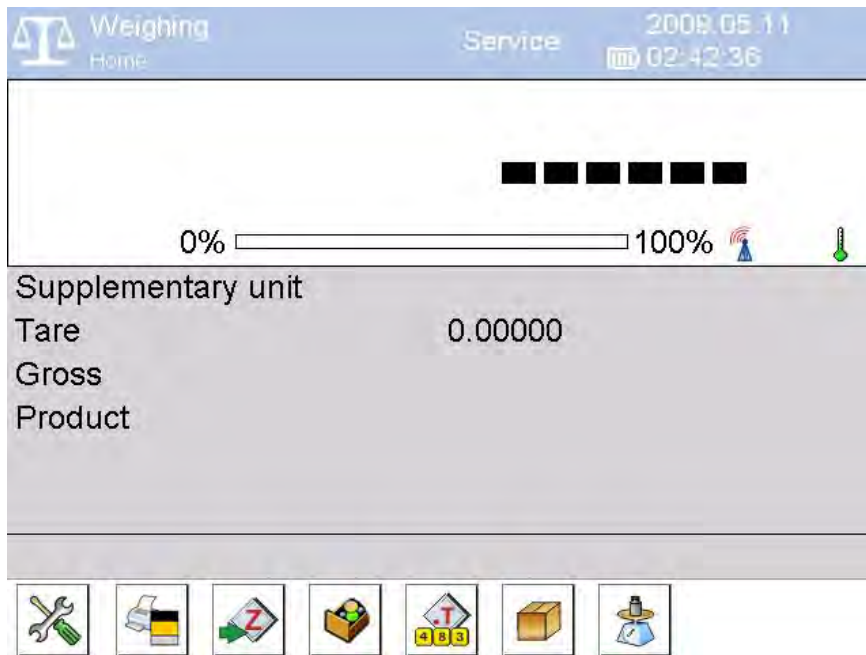



Terminal connected to mains, battery charged, no connection of the terminal with the weighing module.

Settings

For ensuring long enough operation while powering the device by means of battery, the correct parameters of group OTHER must be set, <Sleep mode> <Display brightness>. For more information refer to point 33 of this manual titled Other Parameters.

5. STARTUP

- On plugging the power cord to moisture analyzer's power plug, switch on the moisture analyzer using the main switch located next to the power plug at the back of instrument's housing.
- On switching on, instrument's diode **ON/LOAD**  located on terminal's housing is lit up.
- Press powering key  located on the upper right section of terminal's overlay. Within a few seconds, the RADWAG OS starts loading, which is signaled by flickering red diode ON/LOAD.
- On completing the startup procedure, the instrument's displays main window of the software.
- The moisture analyzer starts up with no user logged in. In order to start operation, a user has to log in. (logging procedure is described further in this user manual).

CAUTION: Remember to start the moisture analyzer up with no load on the drying pan.

5.1. Temperature stabilization period of time

One must wait until the thermal stability of the balance has been reached before carrying out a weighing process.

In case of balances that were stored in low temperature (wintertime) it takes about 4 hours to acclimatize and heat before being plugged to mains. The balances may not be plugged to mains earlier than it has been specified by a manufacturer.

During the stabilization process the display readouts may vary. Correct operation of the balance is possible within a temperature range specified in technical parameters (see point 1 of this manual).





It is recommended to find such a place for balance in operation where the ambient temperature changes are insignificant.

5.2. Moisture analyzer switching off

CAUTION:







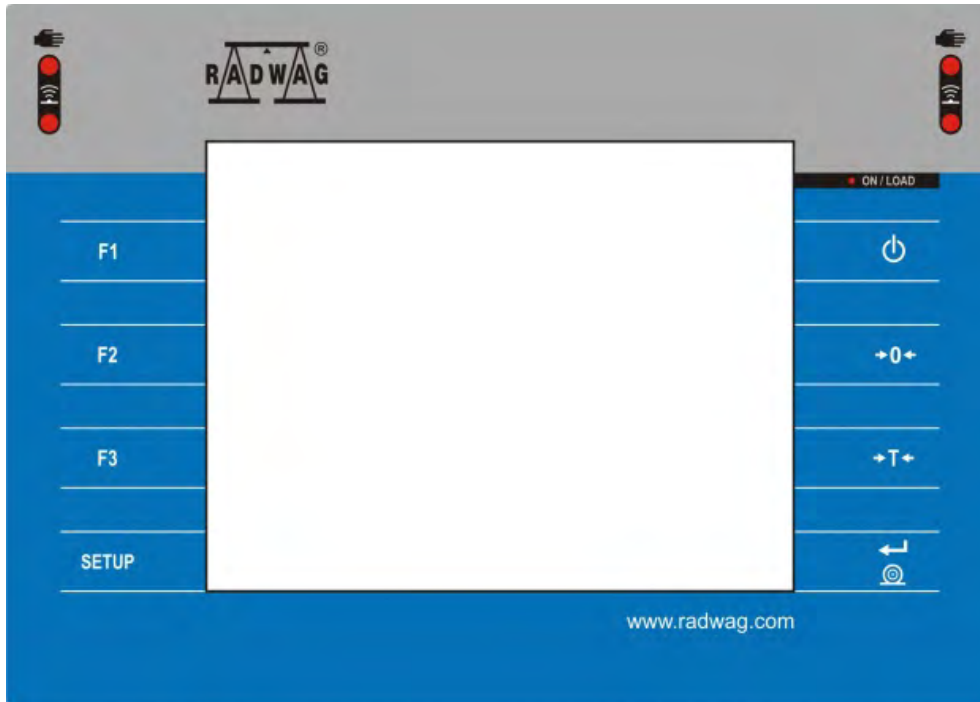

REMEMBER, before unplugging the moisture analyzer from mains, the terminal must be switched off using ON/OFF key located on terminal's overlay!

Procedure:

- Press <  > key located on terminal's overlay
- A window is opened with the following options:
 -  Shut down (switching off operation of the terminal)
 -  Cancel (cancel procedure)
- Press <  Switch off > key
- Switch off the moisture analyzer using the main switch key located at the back of the housing
- Unplug the moisture analyzer from mains.

6. KEYBOARD – FUNCTION KEYS















Key	Description
	Switching the instrument ON / OFF
	Zeroing
	Tarring
	Sending measurement result to a connected printer or computer
	Function key (entering instrument's menu)
	Working mode selection, (programmable key)
	User profile selection, (programmable key)
	Adjustment, (programmable key)

7. SOFTWARE STRUCTURE

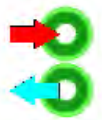
The structure of moisture analyzer's main menu is divided into function groups. Each group comprises parameters grouped by their reference. Description of each menu group is provided further in this user manual.

List of groups - Parameters

Moisture analyzer's main menu is accessed by pressing SETUP function key or  soft key located in the bottom tool bar of terminal's display. The menu comprises parameters referring to moisture analyzer settings, functions and profiles.

 ADJUSTMENT	 USERS	 PROFILES
 DATABASES	 COMMUNICATION	 PERIPHERALS
 INPUTS/OUTPUTS	 ACCESS LEVEL	 OTHERS
 UPDATE	 INFORMATION ON SYSTEM	 MOVIES

8. SOFTWARE MAIN WINDOW

8.9. Weighing window

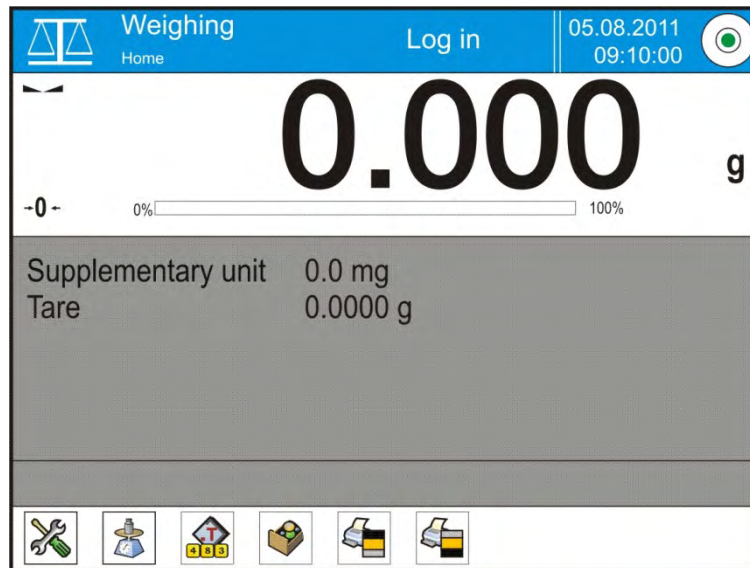

The software's main window is divided into 4 main sections:

- The upper part of the touch screen display contains data on active working mode, logged operator, date, time, active connection to a computer and current level status.



- Below there is a weighing window, indicating measurement result and current measuring unit

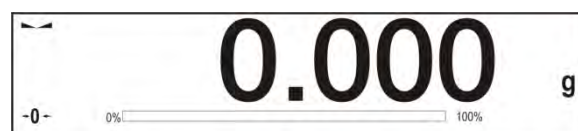

- Under which there is a grey coloured workspace containing additional data on carried out activities

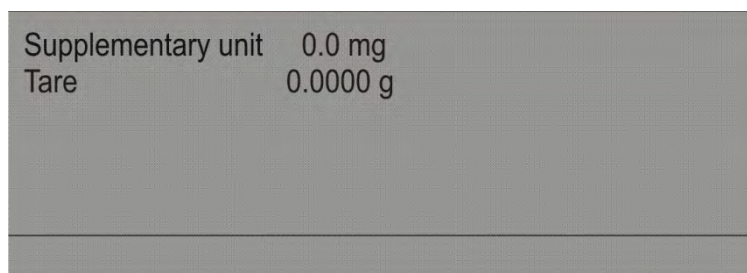

Caution:

Data contained in the workspace is optionally configurable. Configuring process is described in point 16.4 of this user manual;

- Below the workspace there is a set of soft keys:



Caution:

The user can declare the presence of function (quick access) keys. Declaring process is described in point 16.3 of this user manual;

8.10. Drying window

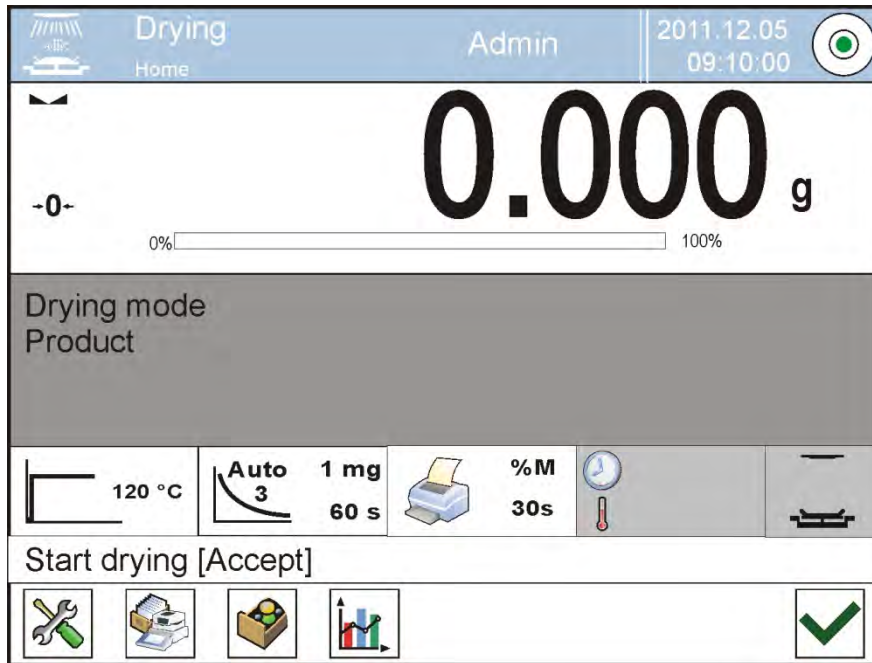

The application window is divided into 4 main sections:

- The upper part of the touch screen display contains data on active working mode, logged operator, date, time, active connection to a computer and current level status.



- Below there is a window, indicating drying result or weighing result

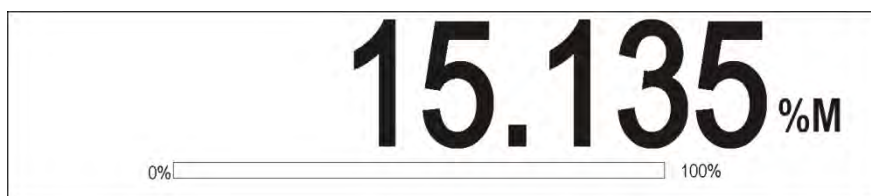

- Under which there is a grey coloured workspace containing additional data on carried out activities

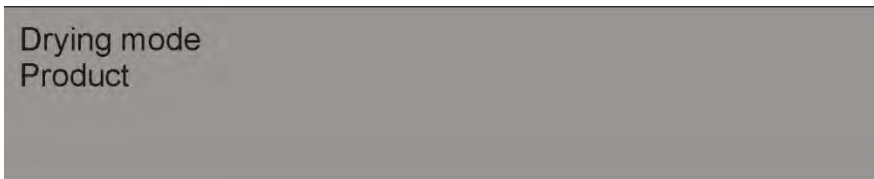

Caution:

Data contained in the workspace is optionally configurable.
Configuring process is described in point 16.4 of this user manual;

- The field may contain data on drying parameters' settings, and current status of a moisture analyzer



- Below the workspace there is a set of soft keys:



Caution:

The user can declare the presence of function (quick access) keys. Declaring process is described in point 16.3 of this user manual;

8.11. Drying result

Drying result is indicated in the main window of terminal's display. The user can enlarge the drying result, to make it well visible from a distance.

Procedure:

In order to enlarge the size of displayed drying result tap the white coloured field with visible drying result.

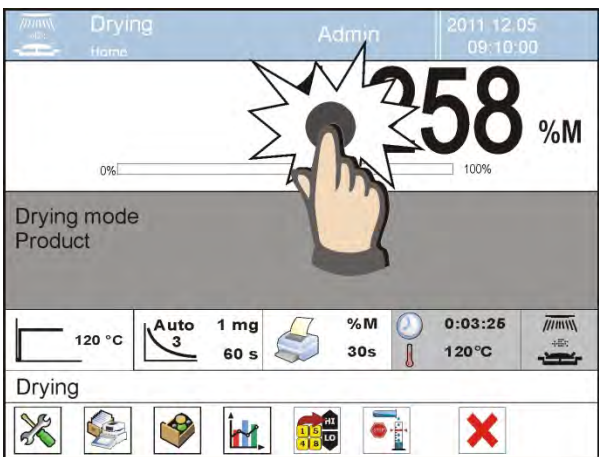



To return to the standard means of displaying a drying result, again tap the white coloured field with visible drying result. The display returns to its default size.

9. LOGGING

Full access to moisture analyzer's parameters and editing databases requires logging to instrument's software as an operator with **<Administrator>** access level. The logging procedure should be carried out on each switching on the instrument.

First log in procedure

- While in the main window of the application, press **<Log in>** text located in the upper bar of the display, which opens a window with operators database including  **Admin>** entry,
- On entering the  **Admin>** entry, the software activates on-screen keyboard for entering operator's password,
- Insert password "1111" and accept it by pressing  key,
- The software automatically returns to displaying the main window, and the display's upper bar indicates word **<Admin>** instead of **<Log in>**,
- If needed, insert user specific name and password, and set administrator's access level. This way, no one except for authorized operator can make changes in moisture analyzer settings.
- After first logging in, the administrator should add user profiles and set their corresponding access level (*the procedure of assigning access levels is described further in this user manual, see point 13 & 14*).

On future logging in, select a user from the list, and on entering password the software initiates operation with access level set for a corresponding user.

Log out procedure

- While in the main window of an application, press name of a logged operator located in the display's upper bar. A window with operators database is opened,
- Press **<Log out>** soft key (*located as position no. 1 in the list of operations*)
- The software returns to the main window, and the display's upper bar indicates word **<Log in>** instead of name of a logged operator.

Access level

Software of moisture analyzer MA 3Y series provides four access levels: *administrator, advanced operator, operator and none (anonymous logging)*. On switching on, the display is constantly active, enabling carrying out measuring processes. These measurements, however, cannot be saved in moisture analyzer's database unless a user with at least minimal access level is logged in. The minimum access level enables carrying out measuring/drying processes and saving them in moisture analyzer's databases using available function.

Below table indicates access to editing user parameters, databases and software functions depending on active access level.















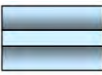

Authorization	Access level
None (guest)	No access to editing all of user parameters. it is not possible to accept a weighing record nor to start a process. No access to menu <Databases>.
Operator	Access to editing parameters in submenu: <Profiles; Readout> and settings in group of parameters <Others>, except for <Date and Time>. The operator can start and carry out all weighing processes, and has access to <Export weighing database to a file> and preview data in <Databases>. An operator can define universal variables.
Advanced operator	Access to editing parameters in submenu: <Profiles; Readout>; <Working modes>; <Communication>; <Peripherals>; <Others> except for <Date and Time>. The advanced operator can start and carry out all weighing processes, and can erase old data from the <Databases>.
Administrator	Access to all user parameters, functions and editing databases.

10. OPERATING USER MENU

MA 3Y series features a touch screen display which makes moving through software menu very simple and intuitive.

Pressing a function key, a soft key or area on the display initiates an assigned function or process.



10.1. Terminal's keyboard

	or		Enter main menu
			Scroll menu upwards
			Scroll menu downwards,
			Fast up and down menu scrolling,
			Accept changes,
			Leave a function unchanged (without saving changes),
			Add items to a database,
			Search for items in a database by date
			Search for items in a database by name
			Search for items in a database by code
			Printout of an item from a database
			Clear the editing field
			Activate / deactivate on-screen keyboard
			Reading printout template from a file format *.lb (function key is active on plugging a data storage device to terminal's USB port
			Selection of variables from a list for a printout
			Moving (exiting) one level up in menu structure.

10.2. Return to weighing mode

Changes introduced in moisture analyzer's memory are automatically (and permanently) saved on returning to displaying the main window.

Procedure:

- Press  key for a few times, until the software returns to displaying the main window.
- press  soft key in the upper bar on the display. The software immediately returns to displaying the main window

11. WEIGHING

Load a weighed object on the weighing pan. On stabilization of weighing result, indicated by stability marker  visible on the left side of the terminal's display, read the measurement result.

Saving / printout of the measurement result is available on pressing <PRINT> key.

Depending on software settings, either stable or unstable measurement result can be printed, if printed measurement result in unstable (stability pictogram  is not displayed), then it is accompanied by question mark <?> in front of printed mass value.

11.1. Selection of measuring unit

Change of measuring unit is carried out by pressing the measuring unit pictogram visible next to the value of measurement result on the display. Pressing the measuring unit pictogram opens a list with available units. On selecting one of them, the software automatically recalculates the indicated mass value to the active measuring unit.

Available measuring units:

Measuring unit	Denotation
gram	[g]
milligram	[mg]
kilogram	[kg]
carat	[ct]
pound	[lb]
ounce	[oz]
ounce troy	[ozt]

pennyweight	[dwt]
Taele Hongkong	[tlh]
Taele Singapur	[tls]
Taele Tajwan	[tlt]
Taele Chiny	[tlc]
Momme	[mom]
Grain	[gr]
Newton	[N]
Tical	[ti]

11.2. Means of correct weighing procedure

In order to ensure long lasting use of a moisture analyzer, correct and reliable measurement of loads, follow below procedures:

- Start the moisture analyzer with no load on the weighing pan (permissible value of load on the weighing pan on instrument start is $\pm 10\%$ of its maximal capacity).
- Load the weighing pan steadily with no shocks:

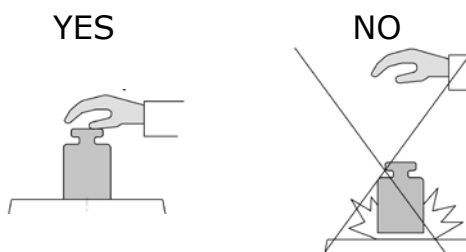

- Place weighed loads centrally on the weighing pan:



- Avoid side loading, in particular side shocks:



11.3. Leveling

A moisture analyzer MA 3Y series features an electronic level control system – AutoLEVEL System:

The AutoLEVEL System in MA 3Y series continuously monitors level status during moisture analyzer operation. The level status is signaled in the upper right corner of terminal's display. The system continuously controls level, and on detecting level change it indicates appropriate information on the display and/or signals an alarm. Then the software opens a window for adjusting the level.

Leveling procedure

- Press level status pictogram  located in the upper right corner of the display.
- The display indicates a control panel of leveling function. Moisture analyzer operator previews level status, and instrument's top elevation.

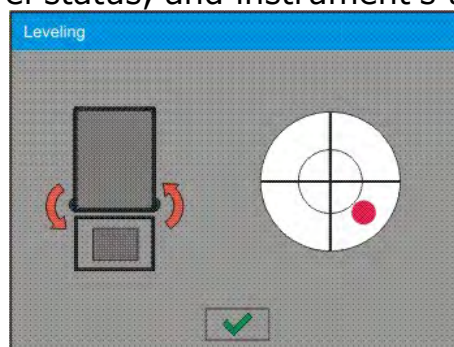

- Level the moisture analyzer by turning the adjustable feet in a way indicated by blinking pictograms on the display  – the level point should move towards the center of the level circle.
- As the level point is in the center point, its colour changes from red to green – which is a confirmation for correct level status.

11.4. Zeroing

In order to zero mass indication press  key.



The mass indication on the display should equal zero, and precise zero **+0+** and stability  markers should appear.

Zeroing process is tantamount to determining new zero point recognized by the moisture analyzer as precise zero. Zeroing is possible only in stable status of display indication.

Caution:

*Zeroing the display indication is possible only within the $\pm 2\%$ range of instrument's maximal capacity. If zeroed value is above the $\pm 2\%$ of the maximum capacity, then the software indicates an error message **Err2**.*

11.5. Tarring

In order to determine net weight of a weighed object, place object's container (packaging) on moisture analyzer's weighing pan, and on stabilization of measurement result press  key. The display should indicate mass equal to zero and symbols: **Net** and . On taking off the weighed load and its packaging from instrument's weighing pan, the display indicates sum of total tarred mass with minus sign.



The software also enables assigning tare value to a product from a database. Then, on product selection from a database, the software automatically uploads data on tare value for the specific product.

Caution:

Tarring negative values is impossible. On tarring negative values the moisture analyzer responds with an error message. In such case zero the indication and repeat tarring procedure.

Manual tare determination

Procedure:

- While in optional mode press quick access key , ,
- Which opens numeric keyboard on moisture analyzer's display,
- Using numeric keys insert desired tare mass and press  key,
- The moisture analyzer returns to weighing mode, and the display indicates inserted tare value with minus "-" sign.

Deleting tare

The tare value indicated on moisture analyzer's display can be deleted by pressing ZERO key on instrument's overlay, or using programmable function key <Deactivate tare>.

PROCEDURE 1 - on taking the tarred load off moisture analyzer's weighing pan



- Press ZERO key
- The NET marker is deleted, and new zero point of the moisture analyzer is determined

PROCEDURE 2 - when the tarred load in on moisture analyzer's weighing pan

- Press ZERO key
- The NET marker is deleted, and new zero point of the moisture analyzer is determined

If tare value exceeds 2% of available maximal capacity, the display indicates error message -Err- (forbidden operation)

PROCEDURE 3 - when the tarred load in on moisture analyzer's weighing pan or on taking the tarred load off the weighing pan

- Press programmable key <Deactivate tare> 
- The NET marker is deleted,
- The display indicates tare value
- Press <Restore tare>  key to restore the last tare value

11.6. Additional parameters on weighing process

Changes in settings of functions related to weighing process can, to some extent, influence moisture analyzer's reactions.

Procedure:

1. Press grey coloured workspace
2. The display indicates menu: Settings, Keys, Information, Printouts, Profile
3. Press one of available submenu options and select item for modification,

Menu <Settings> - additional options related to weighing mode or drying mode

Menu <Keys> - defining quick access keys

Menu <Information> - supplementary data on weighing /drying process displayed in the grey coloured workspace

Menu <Printouts> - selection of printout type

Menu <Profile> - selection of a profile, active during moisture analyzer operation

Menu <SETTINGS> contains supplementary data on weighing process, such as:

- **Tare mode**

- SINGLE,
mass value stored in instrument's memory on single pressing of TARE key, the following pressing of TARE key determines new value of tare. Selection of product or packaging with assigned tare value causes automatic deleting the previously assigned tare value;
- SUM OF ACTIVE,
totalizing applied tare values of a product or a packaging (resulting from selecting a product or a packaging from corresponding database) with a possibility of increasing determined tare value by manual tare introduced manually using moisture analyzer's numeric keyboard. On following determining of tare value for a product or a packaging, the tare value introduced manually is deactivated;
- SUM OF ALL,
totalizing all introduced tare values;
- AUTOTARE
Means of operation:
Each first stable measurement result is tarred. The NET pictogram flashes on the display. The operator can determine net mass of weighed load. On taking off the load from the weighing pan, and as the indication returns to autozero zone, the software automatically deactivates Tare value.

– **Automatic footer printout**

Accessible options:

MODE

No – manual footer printout,

Sum of measurements – the condition for printing a footer is exceeding mass value set in parameter <Threshold>

Number of measurements – the condition for printing a footer is carrying out a pre-defined number of measurements (a batch) set in parameter <Threshold>

THRESHOLD – setting the value of threshold determining footer printout.

For option <Sum of measurements> the value is determined in measuring unit [g], and for option <Number of measurements> the value is not measurable, and determined by number of carried out measurements.

– **Printout mode / value release**

PRINT / VALUE RELEASE key, (manual operation of ENTER key)

- | | |
|--------------|--|
| Never | – printout deactivated |
| First stable | – the first stable measurement is printed |
| Each stable | – all stable measurements are set for printing |
| Each | – printout of all measurements (stable and unstable) |

AUTOMATIC MODE

Never	- printout deactivated
First stable	- the first stable measurement result obtained after placing a load on moisture analyzer's weighing pan is recorded, record of the following measurement result takes place only on unloading the weighing pan, returning of the mass indication below set threshold's value, and placing another load on balance's weighing pan
Last stable	- accepted is the last stable measurement recorded before taking the load off the weighing pan. The record takes place on taking the load off the balance's weighing pan, and returning of the mass indication below set threshold's value.

THRESHOLD – mass value obligatory for operation of automatic printout.
Set in grams.

– **Printout**

Contains type of printout that is related to a working mode. Printout takes place on pressing PRINT key on moisture analyzer's overlay.

Accessible options:

- STANDARD PRINTOUT
Possible declaration of printout content: HEADER, WEIGHING DATA and FOOTER.
printout components marked as <YES> in the menu are printed on pressing printout activating function key.
- NON-STANDARD PRINTOUT
Database of printouts enables selecting one of available non-standard printouts visible in menu <PRINTOUTS>, or designing a unique printout which is automatically added to the databases.

Caution:

Means of designing printouts is described in point 16.5 of this user manual.

11.7. Minimum Sample Weight

The weighing mode settings comprise a function of <Minimum sample>. The function is enabled on specifying in the database <Database/Minimum sample > parameters on methods for determining the minimum sample and the values of minimal sample weight specific for a method. In standard version, this database item is not filled in with data.

Activities related to determining minimum sample and adding data to the database: <Databases/Minimum samples> are accessible only for an authorized "RADWAG" personnel.

Should balance operator use the minimum sample mode, and data on minimal sample weight are not entered to balance menu, then please contact the local representative of "RADWAG" company.

An authorized RADWAG representative determines the minimum sample dependent on packaging mass. The process is carried out with mass standards, in balance place of use and in accordance with the requirements of the accepted quality system. The obtained values are entered to balance software: <Databases/Minimum samples>.

A minimum sample determining method may have a few tare values defined, along with assigned values of minimum samples, expiry dates of the carried out measurements and entered data. The settings are not to be edited by balance user.

Using <Minimum sample> mode guarantees that the results of completed weighing processes are within set tolerance limits, and they comply with the requirements of the quality system accepted by an organization.

CAUTION: the mode operates in the weighing mode only.

Available options:

- **METHOD**
It is a means for designating an accepted quality standard. Pressing a field displays a window with a list of minimal sample weight values stored in balance's memory, following a criterion on determining the minimum sample. Adding a new method is available only from the menu level <Databases /Minimum samples>
- **MODE**
Lock – on selecting this option and during the weighing process the display indicates corresponding pictograms that inform a user whether the weighed mass is below or above the minimum sample limit. Additionally the software disables accepting the measurement result if it is below the minimum sample limit
Warn – on selecting this option and during the weighing process the display indicates corresponding pictograms that inform a user whether the weighed mass is below or above the minimum sample limit. The user can accept a measurement that is below the minimum sample limit, but on a printout such measurement is preceded by an asterisk (*).

CAUTION:

Means of setting a method of minimum sample determining is described in point 27.9. of this user manual: <Databases /Minimum sample>. RADWAG authorized personnel is only authorized to add new values of minimum samples.

Weighing with application of <MINIMUM SAMPLE> mode

If during a weighing process a user wants to be informed whether a measurement exceeds the minimum sample limit for a specific weighing

threshold, then the <Minimum sample> mode has to be enabled in the additional setting of the weighing mode.

Procedure:

1. Press grey coloured workspace
2. The display indicates menu: Settings, Keys, Information, Printouts and Profiles
3. Select menu <Settings> - additional options on weighing process
4. Press <📏 Minimum sample> field
5. Below window is opened

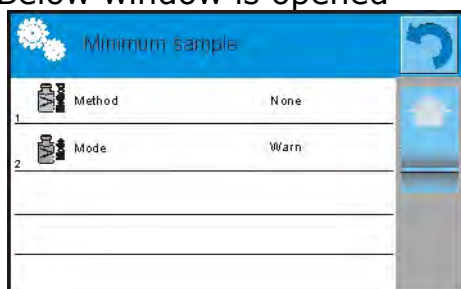

6. Press <Method> field
7. Which opens a window containing a list of minimum sample methods stored in balance database.
8. Select one of available entries.
9. The software returns to the previous menu window
10. Press <Mode> field
11. Which opens a window with parameter settings. Select one of below options:

Lock – on selecting this option and during the weighing process the display indicates corresponding pictograms that inform a user whether the weighed mass is below or above the minimum sample limit. Additionally the software disables accepting the measurement result if it is below the minimum sample limit

Warn – on selecting this option and during the weighing process the display indicates corresponding pictograms that inform a user whether the weighed mass is below or above the minimum sample limit. The user can accept a measurement that is below the minimum sample limit, but on a printout such measurement is preceded by an asterisk (*).

12. On setting the parameters exit the menu.
13. The mass field on the display is supplemented by an additional informative pictogram. The pictogram changes during weighing process and indicates current status of mass in relation to the pre-determined value of minimum sample.







- Mass below the set value of minimum sample



- Mass above the set value of minimum sample for a given tare range







Meaning of the pictograms of minimum sample mode:

	<p>Mass below the set value of minimum sample.</p>
	<p>Mass above or equal to the value of minimum sample.</p>
	<p>Mass below the set value of minimum sample. A pictogram with a clock informs on approaching expiring of the validity period of the minimum sample (it is displayed two weeks before the determined expiry date).</p>
	<p>Mass above the set value of minimum sample. A pictogram with a clock informs on approaching expiring of the validity period of the minimum sample (it is displayed two weeks before the determined expiry date).</p>
	<p>The validity term of the minimum sample has expired. Changes are needed in the minimum sample settings. Only authorized RADWAG personnel can change the minimum sample settings.</p>

Caution: If more than one reference tare value is programmed (with corresponding minimum sample mass) then the indicated value automatically moves to a range corresponding to the weight of the tarred container. At the same time the required minimum mass is changed.

11.8. Cooperation with titrators

In order to ensure correct cooperation with TITRATORS it is necessary to set <Mass for titrator> option to <YES> value. The setting must be done for standard printout content. Any other variables for this printout must be off.

Weighing printout template		
20	 MW-Method	No
21	 Reference tare	No
22	 Minimum sample	No
23	 Minimum sample status	No
24	 Mass value for a titrator	No
25	 Non-standard printout	None

If the option is on, the user shall notice an icon informing about specific mass printout format accepted by TITRATORS. The icon is located in the top toolbar of the main window.

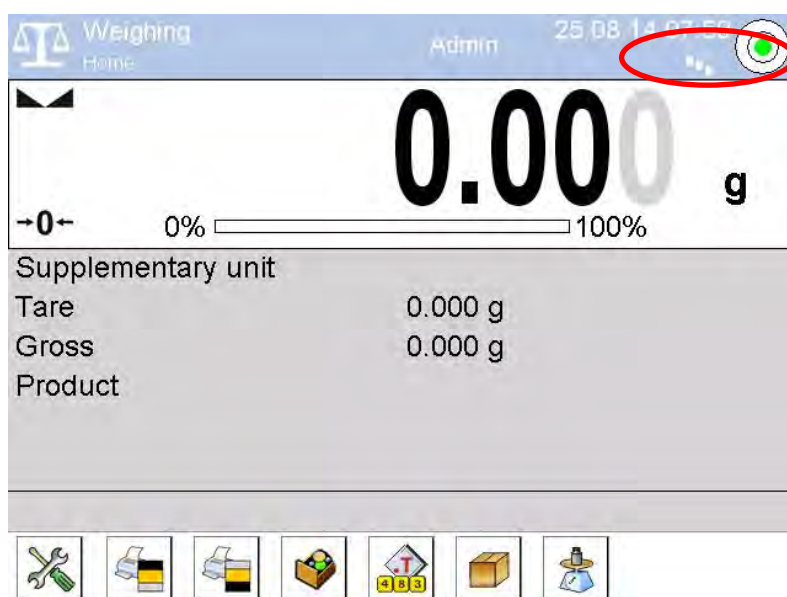

12. ADJUSTMENT

Moisture analyzers MA 3Y series feature adjustment (calibration) option, which ensures their correct measurement accuracy. Menu <ADJUSTMENT> contains functions controlling operation of moisture analyzer's adjustment process, including options:

12.1. External adjustment

External adjustment is carried out using an external adjustment weight, with appropriate accuracy and mass relating to moisture analyzer's type and maximum capacity. The process takes place semi-automatically, and the following process phases are indicated on terminal's display.

Process course:

- Enter submenu < Adjustment > and select option: "  External adjustment",
- The display indicates the following message box:



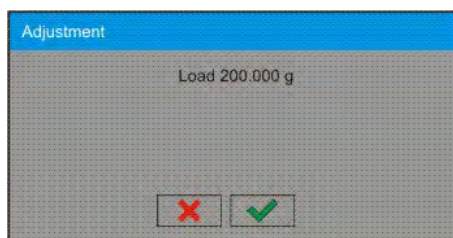

- If there is a load on moisture analyzer's weighing pan, unload it,
- Press  key. The moisture analyzer determines start mass, which is indicated by a message box: "**Start mass determination**" on the display,
- On determining the start mass, the moisture analyzer displays a message box:

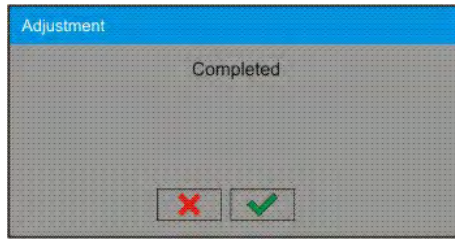

- Acting according to displayed command, place an ordered weight/mass standard on the weighing pan and press  key,

- On completing the adjustment procedure the moisture analyzer indicates a message box:



- On confirming the message box with  key, the moisture analyzer returns to the main mode

12.2. User adjustment

User adjustment is carried out with an optional standard, which mass ranges between $0,15 \text{ Max} \div \text{Max capacity}$. Adjustment procedure is compatible with the external adjustment process, but before its start the software opens a message box for entering mass of a standard used for user adjustment procedure.

In order to start user adjustment, enter submenu < Adjustment >, and select option: "  User adjustment". Then follow the commands indicated on the display.

12.3. Temperature adjustment

Temperature adjustment is carried out with a dedicated kit, that is an optional equipment of the moisture analyzer MA 3Y series.

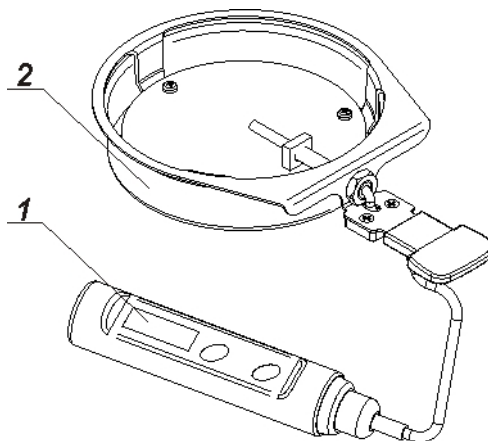

1. Thermometer
2. Thermometer holder and drying chamber shield

Adjustment of the drying chamber temperature is a process carried out for the purpose of adjusting the temperature sensor assembled inside the drying

chamber of a moisture analyzer. Before starting temperature adjustment process, place the temperature calibration kit inside the drying chamber, following below diagrams:

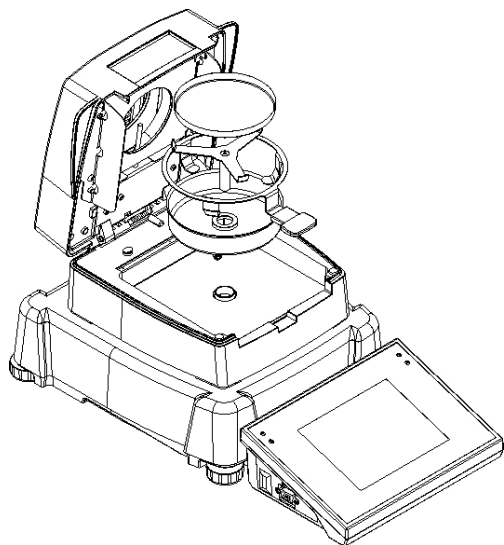

Step 1.

Remove from the drying chamber the following:

- disposable pan
- drying pan handle
- cross-shaped holder
- drying chamber insert

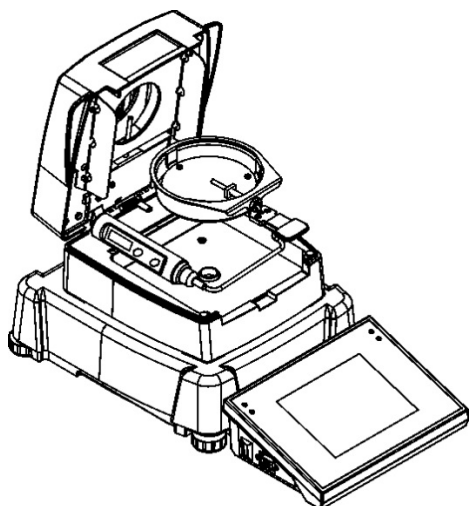

Step 2.

Assemble in the drying pan the components of temperature adjustment kit:

- drying chamber shield
- thermometer holder and the thermometer

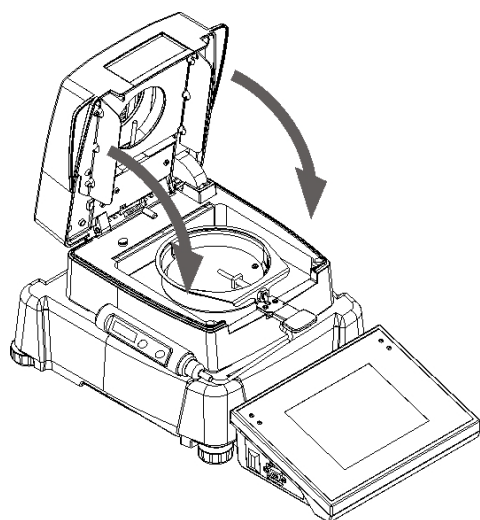

Step 3.

After assembling the kit start temperature adjustment process.

CAUTION:

All the activities must be carried out with great caution not to damage the measuring mechanism of the moisture analyzer.

Before starting the temperature adjustment process, close drying chamber lid and follow below process descriptions:

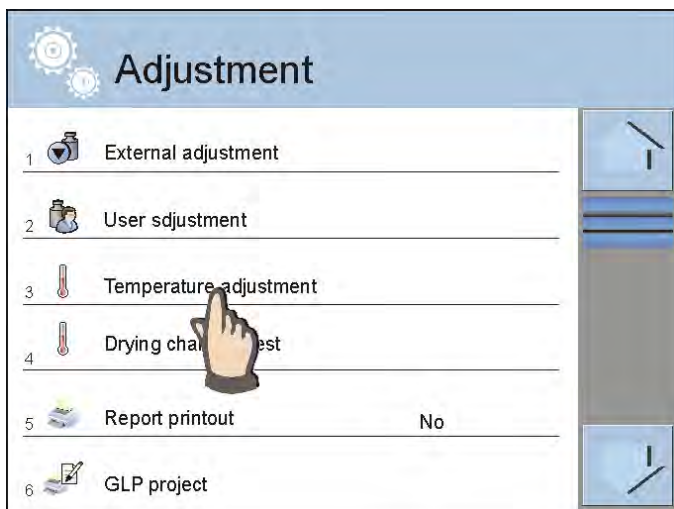

Enter submenu group <Adjustment>. Start <Temperature adjustment> application by pressing field with its name.



The moisture analyzer displays a message box on procedure start, and data on the process (step number, current temperature value, heating time, burn-in (heating) time).



After 8 minutes, the system opens a window with an on-screen numeric keyboard. Using the on-screen keyboard insert the current temperature value of the moisture analyzer, that is indicated on the external control thermometer. Press <Accept> key to proceed to the following adjustment step.

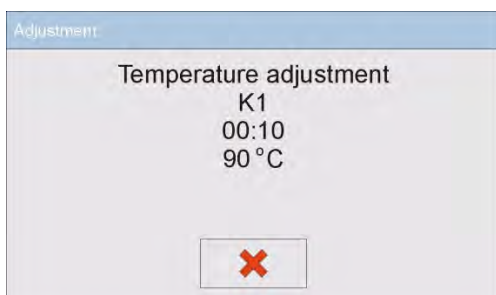

The moisture analyzer switches on the halogen heater and for another 8 minutes it heats the drying chamber and simultaneously displays current temperature value and other parameters.



After 8 minutes, the system opens a window with an on-screen numeric keyboard. Using the on-screen keyboard insert the current temperature value of the moisture analyzer, that is indicated on the external control thermometer. Press <Accept> key to proceed to the following adjustment step.

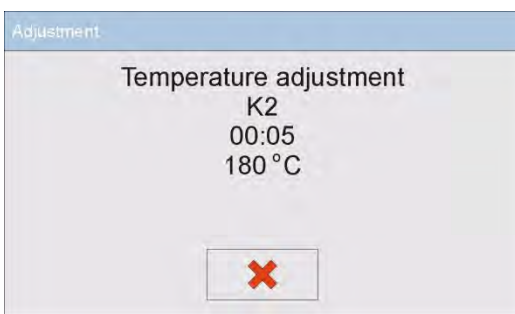

The moisture analyzer proceeds to the last step of adjustment process. It heats the drying chamber to a higher temperature and for another 8 minutes it maintains this temperature and displays its value.



After 8 minutes, the system opens a window with an on-screen numeric keyboard. Using the on-screen keyboard insert the current temperature value of the moisture analyzer, that is indicated on the external control thermometer. Press <Accept> key to proceed to the following adjustment step to complete temperature adjustment procedure.

On completing temperature adjustment procedure, the moisture analyzer displays a corresponding message box. Accept the message box by pressing <ACCEPT> key and return to the main window.

12.4. Drying chamber test

Parameter <Drying chamber test> enables monitoring the temperature as indicated by the moisture analyzer's internal thermometer.

The testing procedure is carried out using a dedicated kit, available as optional equipment of the moisture analyzer. Means of assembling the testing kit is described in the previous point (temperature adjustment).

In order to start the testing procedure assemble the testing kit inside the drying chamber, and next go to menu group <Adjustment> and start the procedure by pressing <Drying chamber test> field.

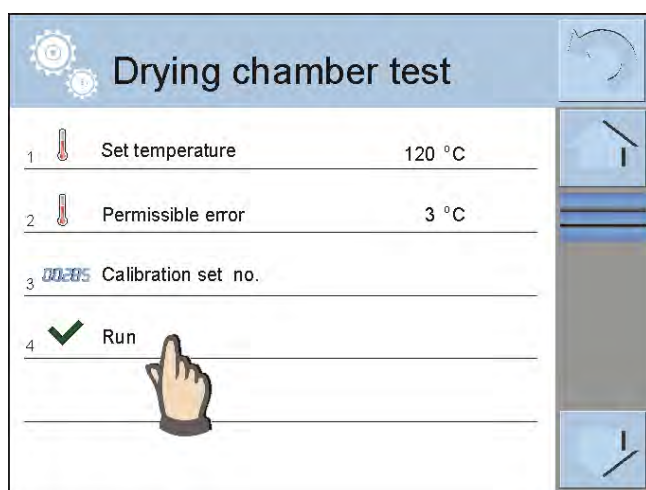
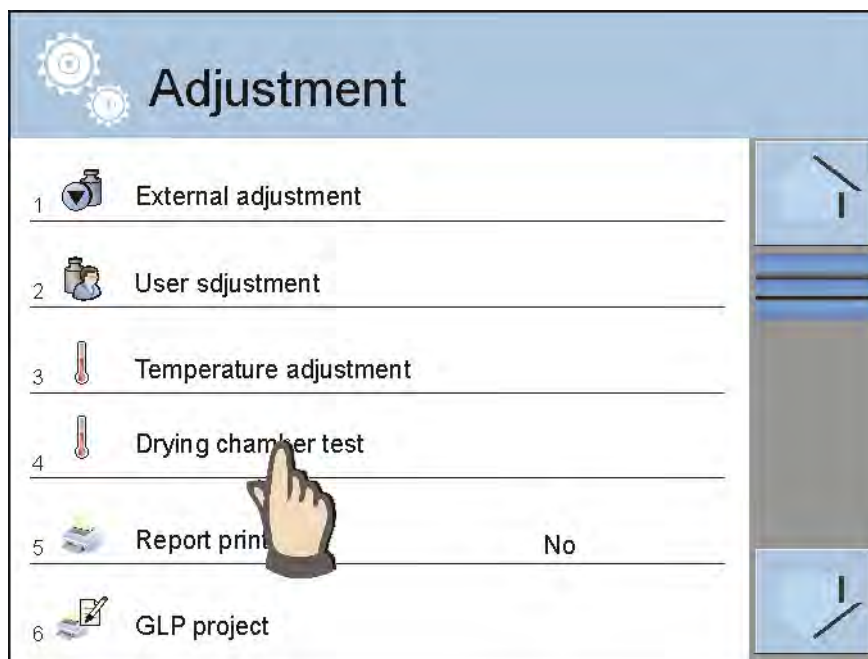

A new window is opened for entering temperature value set for checking the moisture analyzer. Then enter a permissible error for the set temperature value (the error cannot be lower than the default factory value). Next enter the factory no. of the temperature adjustment kit, and press <Run> field. The software orders heating the drying chamber. Control time for a given temperature value is 8 minutes.

During the heating time the moisture analyzer displays a window with current data on temperature inside the drying chamber and heating time.

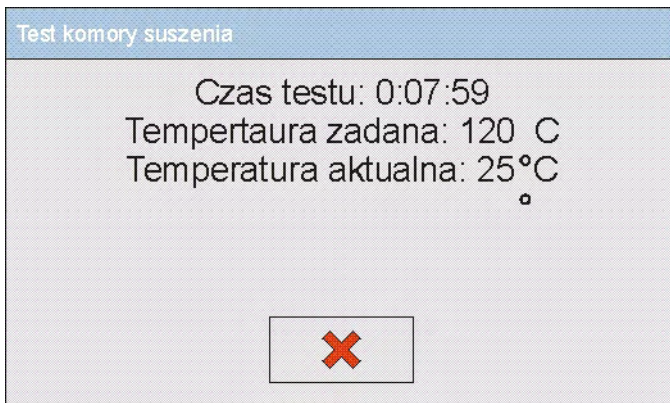

After test completion (i.e. after testing time) the software displays window with an on-screen keyboard for entering the temperature value as specified on the external thermometer of the temperature adjustment kit.



Enter and accept the temperature value. The software displays a window on test summary.

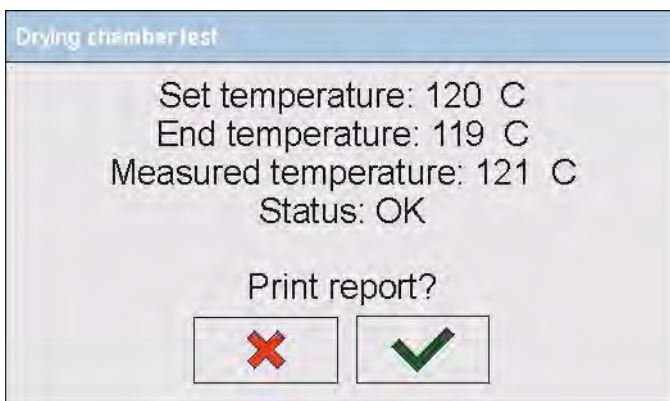

In the test summary window, the user can order printing a report from drying chamber test. On selecting one of the available options the software automatically returns to displaying the menu window: <Adjustment>.



An example of a report from drying chamber test:

```
----- Drying chamber test -----  
Start time      2012.10.30 13:57:05  
Balance model   MA 3Y.NH  
Balance ID      1352  
Adjustment kit no.  
  
Target temperature    120 °C  
End temperature       119 °C  
Measured temperature  121 °C  
Permissible error     +/- 3 °C  
Status                OK
```

The report is not stored in moisture analyzer memory. Exiting the report immediately deletes it from the moisture analyzer volatile memory.

If a user aborts the testing process, the summary window will not be displayed, and the software automatically returns to displaying the menu window <Adjustment>.

12.5. Adjustment report printout

Parameter <  Report printout > refers to mass adjustment process only and it determines whether or not a report from adjustment should be automatically printed on its completion. Setting automatic report printout on adjustment completion. Go to parameter: <  Report printout > and select option <YES>.

12.6. GLP project

GLP is one of means for maintaining documentation from work in accordance with adopted quality system. Data selected for printing are printed on each release of a report from mass adjustment process.

Moisture analyzer MA 3Y series enables comprising in a GLP report the following information and signs:

- adjustment (adjustment mode)
- working mode (name of a working mode)
- date, time,
- user,
- moisture analyzer type,
- instrument ID,
- level status,
- nominal mass,
- current mass
- difference
- temperature,
- blank line,
- dashes,
- signature,
- non-standard printout.

12.7. Adjustment history

Contains data on all carried out adjustment processes. The record is carried out automatically. Each entry on adjustment comprises basic data on completed process. Moisture analyzer menu enables displaying the list of completed adjustment processes, and each report is printable.

Printing a report from adjustment process:

Enter submenu < Adjustment >, and: <Adjustment history>, then select printing adjustment entry from a list. On displaying details of a record, press print soft key <  > on display's upper bar.

Hint:

If memory on records on completed adjustments is full, then the oldest record is automatically erased.

If internal procedures of an organization require maintaining complete documentation from all carried out adjustment processes, then the list with records on adjustment should be periodically printed and filed.

Searching for adjustment record

Moisture analyzer enables searching for a specific record from completed adjustment processes. Press search icon  and insert date of adjustment process. The software automatically searches for a record and previews it on the display.

Exporting data on completed adjustment process

Connect a data storage device to moisture analyzer's USB port. Press <Data export> key located in the upper right corner of the display. The process is fully automatic, and on its completion, a file with extension *.tdb is saved on a data storage device connected to the USB port. The file is editable using Excel spreadsheet or a text editor.

13. USERS

Menu "Users" contains list of operators, who are authorized to operate the moisture analyzer.

The following data can be defined for each moisture analyzer operator:

- Name
- Code
- Password
- Access level
- Language
- Profile
- Card no.

Adding a new user can only be carried out by a user with Administrator authorization level. In order to add a new user, enter submenu <Users>:

- Press <Add>  soft key
- Define all necessary fields for a new created user

Caution:

Search for a user in database of users by code or name

Edit data on a user:

- Press field with name of a user
- The display indicates data on a specific user
- Select and change necessary data

Deleting a user can only be carried out by an Administrator.

To delete a user:

- Press and hold user name
- A menu is opened referring to a user record
- Select option <Delete>





14. ACCESS LEVEL

Access level  in a moisture analyzer determines scope of activities that a user can carry out. This menu can only be modified by an Administrator.

Anonymous user

An Administrator can grant access level to a moisture analyzer's user who is not logged in (i.e. Anonymous user).

Procedure:

Enter group of parameters < Access level>, select option < Anonymous user>, and set appropriate access level for the anonymous user. Available access levels for an anonymous user: **Guest**, **User**, **Advanced User**, **Administrator**.



Caution:

Setting <Guest> access level causes that logged user has no permission to change any software settings.

Date and time

Moisture analyzer default settings enable a user logged as the **Administrator** for changing date and time settings. However, the software also enables changing required access level to modify option < Date and time>.

Procedure:

Enter group of parameters < Access level>, select option < Date and time>, and set desired access level required to modify the settings. Available access levels for changing date and time settings are: Guest, User, Advanced User, Administrator.



Caution:

Setting <Guest> provides free access to date and time settings (no need to log in).

Printouts

Default software settings enable a user logged as the **Administrator** editing default printout templates. However, the software also enables changing required access level to modify option < Printouts>.

Procedure:

Enter group of parameters < Access level>, select option < Printouts>, and select one of available options: Guest, User, Advanced User, Administrator.



Caution:

Setting <Guest> access level provides free access to printouts settings (no need to log in).

Databases

The Administrator is also authorized to set access level required to modifying each of the databases.

Procedure:

Enter group of parameters < Access level>, select option < Databases>, and set desired access level: Guest, User, Advanced User, Administrator for each of the databases.

Caution:

Setting <Guest> access level causes that access to editing each of the databases is free.

15. PROFILES

A Profile is a data pack determining:

- functioning of working modes, e.g. weighing and drying,
- type of data displayed during working mode operation,
- active function keys,
- accessible set of measuring units
- mandatory criteria for moisture analyzer's speed of operation and measurement stability,

The software enables creating numerous profiles, which in practice provides:

- each user to create their own and individual operating environment
- moisture analyzer operation can be easily programmed by activating used defined function keys and information on process (improving ergonomics of operation)

15.1. Creating a profile

A default profile is named <Home>. The Administrator can create new profiles by:

- Copying an already existing profile and its modification
- Creating a new profile



Copying an existing profile

Procedure:

- Enter moisture analyzer's main menu by pressing **Setup** key,
- Enter submenu < Profiles> ,
- Press and hold an entry with profile name that should be copied,
- A menu is opened referring to available options:
 - Edit
 - Delete
 - Copy
 - Cancel
- Select option <Copy>
- A new profile named <Copy *name*> is created, and all setting are the same as in the base profile,
- After copying change necessary data in a profile: (name, etc.)

Creating a new profile

Procedure:

- Enter moisture analyzer's main menu by pressing **Setup** key,
- Enter submenu < Profiles> ,
- Press  key, which opens a message box: <Create new record?> ,
- Accept the message box by pressing  key. The software automatically adds a new record and enters its editing mode.

Caution:

Adding a profile is only enabled after logging in as an Administrator .

Deleting a profile

Procedure:

- Enter moisture analyzer's main menu by pressing **Setup** key,
- Enter submenu < Profiles> ,
- Press and hold an entry with profile name that should be deleted,
- A menu is opened with a list. Select option <Delete> from the list,
- A message box is displayed which requires confirming profile's deleting: <Confirm to delete> ,
- Accept the message box by pressing  key, the profile is deleted.

Caution:

Deleting a profile is only enabled after logging in as an Administrator.

15.2. Profile structure

Each profile contains the following entries:

Settings	This menu enables setting an individual profile's name (a sequence of alphanumeric characters), and declaring a default working mode (the selected mode is activated as default on profile selecting).
Working modes	Contains the following submenu: <ul style="list-style-type: none">▪ Additional setting of a working mode▪ Function keys▪ Displayed information▪ Printouts
Readout	Contains the following submenu: <ul style="list-style-type: none">▪ Filter▪ Value release▪ Autozero▪ Last digit
Units	Menu enables declaring the start unit, the supplementary unit, 2 custom units and entering the value of gravitational acceleration force in moisture analyzer's place of use (the value of gravitational acceleration force is needed to correct calculating mass in [N]).

15.3. Settings

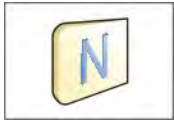

Name

On entering this option, the display opens a message box with keyboard. Insert name of a profile and accept it by pressing  key.

The name is assigned to the profile.



Default working mode

On entering this option the user can select a specific working mode, which is set as default in a profile. In case option <None> is selected, then on selecting the profile, the moisture analyzer activates the last used working mode.

15.4. Working modes

On entering this option, the display opens a window containing all accessible working modes. The users can introduce their settings to each of the working modes which are activated on selecting a specific profile.

In each of the working modes, the user can change the following parameters:

- **Settings**
contain specific parameters relating to a working mode and universal settings, such as: result control, tare mode, automatic footer printout, printout mode, printout.
- **Functions of quick access keys**
declaring quick access keys, which are visible in the bottom display bar
- **Information**
declaring information which is visible in the grey coloured workspace
- **Printout**
declaring type of printout or defining a non-standard printout

15.5. Readout

The function enables the user to adjust moisture analyzer's operation to ambient conditions (filter settings) or individual user needs. Menu <Readout> contains the following elements:

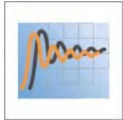

FILTER

Each measurement signal before being displayed is electronically processed for the purpose of obtaining corrected parameters specific for stable measurement result, i.e. ready to read.

In a specific extend a user can influence the range of signal processing by selecting an appropriate FILTER value. Available options:

- very fast
- fast
- average / normal
- slow
- very slow

While setting the filtering level the user should consider the actual operating conditions of a moisture analyzer. In case of very good operating conditions set the filter to average/normal or fast, in case of rough conditions set the filter to slow or very slow.



Value release

This parameter determines displaying the stability marker for a measurement result.

There are 3 available settings of value release parameter

- fast
- fast + reliable /recommended/
- reliable

Caution:

The speed of stability marker occurrence depends on applied filter value and applied value release parameter



Autozero function

The function is to automatically monitor and correct zero indication.

If the function is enabled, the following measurement results are compared to each other in constant time intervals. If the results differ less than declared AUTOZERO range, e.g. 1 division, the moisture analyzer is automatically zeroed, and the markers of stable indication  and precise zero **0** are displayed.

Active AUTOZERO means, that each measurement starts from the precise zero point. There are, however, cases where the function may disturb the measuring process, for instance during very slow load placing or pouring onto the moisture analyzer's weighing pan. In such case, the zero indication correcting system may also correct the actual indication of a load placed on the weighing pan.

Accessible settings: **NO** - autozero function disabled
 YES - autozero function enabled



Last digit

The function determines visibility of the last decimal place indicated on measurement result. The functions provides three settings:

- **Always:** all digits are constantly visible
- **Never:** last digit is blanked
- **When stable:** last digit is displayed only on stable measurement



Environment

This parameter refers to environmental factors influencing balance operation. It has two options: *stable* and *unstable*. If the influencing factors are not stable it is recommended to set the parameter to option *unstable* (by default it is preset to *stable*). This option shortens the measurement time and thus makes the measurement faster than for *unstable* option.

- **Unstable**
- **Stable**

15.6. Measuring units

This menu enables an operator of a moisture analyzer to declare the following profile settings: start unit, supplementary unit and two custom measuring units.

A custom measuring unit features:

- o A multiplier
- o A name (3 characters)

If a custom unit is designed, then its name is added to the list of accessible measuring units.

This menu additionally enables inserting the value of gravitational acceleration force for moisture analyzer's place of use. It is obligatory should a moisture analyzer be used to determine mass in [N].

16. WORKING MODES – general information

A moisture analyzer MA 3Y series in its standard version features the following working modes:



Weighing

Means of operation: weight of a load is determined through an indirect measurement. A moisture analyzer measures gravitational acceleration force which attracts the load. Obtained data is processed into a digital format and displayed in a form of measurement result.



Drying

Means of operation: determining moisture content in a sample, obtained by vaporization of all moisture components from a sample placed inside a drying chamber of a moisture analyzer. A measurement result is automatically calculated by the software and visualized on an ongoing basis on moisture analyzer's display by comparing mass of a sample on measurement start, in progress, and at the end of drying process.

The settings of <DRYING> mode provide access to special functions. They enable adapting mode's operation to user's individual needs. The special settings are activated on selecting a corresponding profile. A detailed description of the mode is presented further in this user manual.

16.1. Working mode selection

Changing working mode:

- Press name of an active working mode, displayed in the left corner of the upper bar.

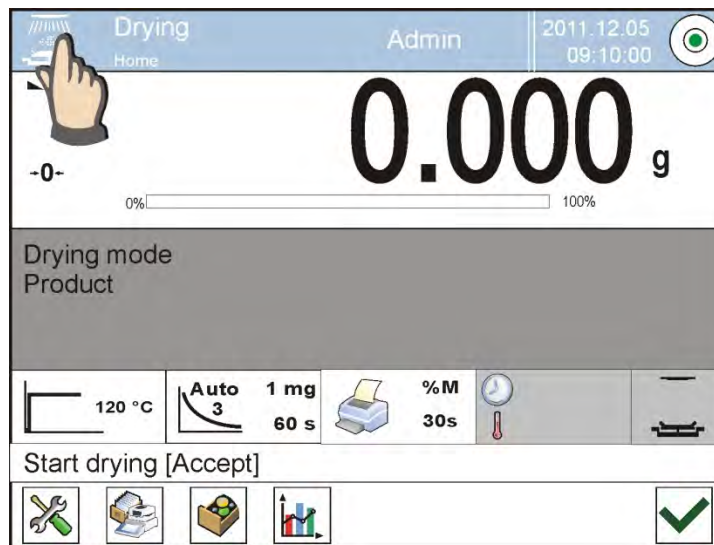

- List of available working modes is displayed,

- Select name of a desired working mode, and press it

16.2. Parameters related to a working mode

Each working mode has programmable parameters determining its functioning. Procedure of determining these parameters:

1. Press grey coloured workspace area
2. Below menu is displayed:
 - <Settings> - additional options related to a mode
 - <Keys> - defining quick access keys
 - <Information> - selecting information displayed in the workspace
 - <Printouts> - selecting type and content of a printout
 - <Profile> - selecting a profile, which is active during moisture analyzer's operation

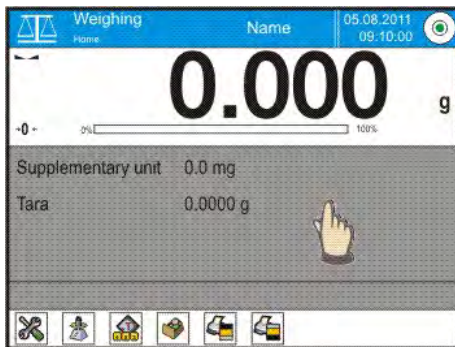

3. Press corresponding menu item and select area for modification,

Description of basic parameters accessible in <Settings> tab is provided in point 11.6 of this user manual "Additional parameters on weighing process". Other parameters specific to each of working modes are presented in working modes description.

16.3. Quick access keys

A user can define up to 7 quick access keys, which are displayed in the bottom bar.

On assigning a function to a specific key, a corresponding soft key appears, and it is located in the bottom navigation bar of the main window.

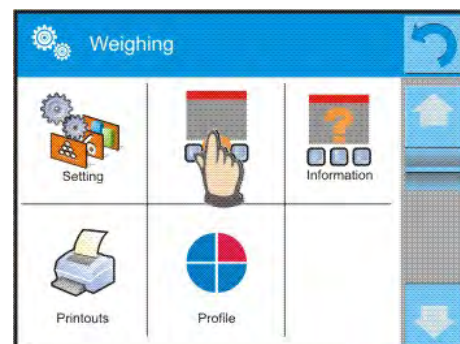

It is a so called quick access key, dedicated for most often used functions and processes.

Caution:

It is possible to view user manual saved to device memory. In order to

take advantage of such function help button  must be placed on a tool bar.

16.3.1. Proximity sensors

The balance comprises two proximity sensors enabling wave control of the balance therefore the user does not have to either press any key on the overlay or touch the screen.

The program recognizes 4 types of motions performed near the sensor:

1. Placing hand near the left sensor <Left proximity sensor>
2. Placing hand near the right sensor <Right proximity sensor>
3. Motion to the left <Proximity sensor: left motion>
4. Motion to the right <Proximity sensor: right motion>

CAUTION: using option LEFT MOTION or RIGHT MOTION, it is necessary to remember that <Proximity sensors delay> parameter must be set to value **500 ms!**

To each of the motions, one of the available options may be assigned: [None; Profile; Adjustment; Zeroing; Tarring; Tare setting; Tare switch off; Reset tare; Packaging; Print; Header printing; Footer printing; Unit; Universal Variable 1; Universal Variable 2; Universal Variable 3; Universal Variable 4; Universal Variable 5; Confirm; Abort; User; Left door; Right door; Open/Close door; Parameters; Product, Warehouse; Client]. The selected option is recognized by the program and performed when activated by a particular motion.

In order to ensure correct operation the user must remember to set the right sensors sensitivity and the right value for proximity sensors delay (for more information refer to point 33 of this manual).

16.4. Information

Information on current process is displayed in the grey coloured workspace. It contains maximally 4 pieces of information. If larger amount of data is selected, then only the first 4 are displayed. Each parameter features two option:

- YES, information enabled (displayed in the workspace)
- NO, information disabled

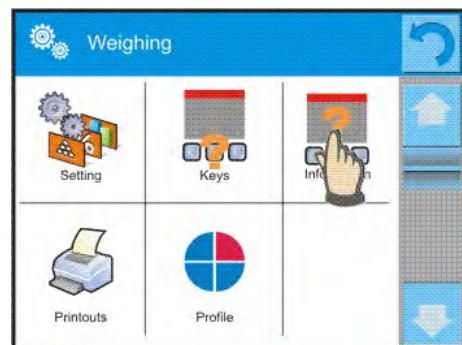

16.5. Printouts

Menu printouts comprises two separate sections. The first one is standard printouts, the other one is non-standard printouts.

- **Standard printout**

comprises three internal sections featuring different variables. For each variable set option YES to include it in a standard printout. If option NO is selected, then the variable is disabled, i.e. it is not printed.

PROCEDURE:

1. Press field with name of a template to be edited (Header – Weighing – Footer) and select variables to be printed
2. If a printout is a non-standard one, create it.

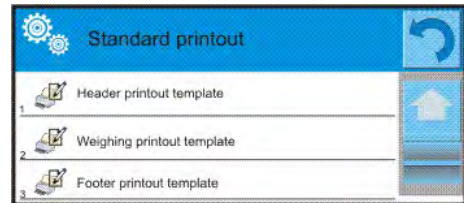

- HEADER

- Dashes
- Working mode
- Date
- Time
- Balance type
- Balance ID
- User
- Level status
- Client
- Warehouse
- Product
- Packaging
- Universal variable 1 ... 5
- Empty line
- GLP report
- Non-standard printout



- WEIGHING

- N (number of measurements)
- Date
- Time
- Level status
- Client
- Warehouse
- Product
- Packaging
- Universal variable 1 ... 5
- Net
- Tare
- Gross
- Current measurement result



- Supplementary weighing unit
- Mass
- Non-standard printout
- **FOOTER**
 - Working mode
 - Date
 - Time
 - Balance type
 - Balance ID
 - User
 - Level status
 - Client
 - Warehouse
 - Product
 - Packaging
 - Universal variable 1 ... 5
 - Dashes
 - Empty line
 - GLP report
 - Signature
 - Non-standard printout



BASIC PRINCIPLES FOR USING PRINTOUTS

1. Press PRINT key on moisture analyzer's overlay to print variables that are contained in section WEIGHING of the standard printout, and if they are attributed = YES (see above list of variables in printouts).
2. Variables attributed as YES present in the HEADER and FOOTER are printed **ONLY** on pressing **Print Header** and **Print Footer** soft keys. The soft keys have to be added to the bottom bar of the display, as quick access keys.

Adding quick access keys on the bottom bar of the display is described in point 16.3 of this user manual.



Print data from header

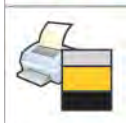

Print data from footer

Caution:

Measuring units for printing mass indication:

- Net – main measuring unit (adjustment unit)
- Tare – main measuring unit (adjustment unit)

- Gross – main measuring unit (adjustment unit)
- Current result – currently displayed measuring unit
- Supplementary unit – supplementary measuring unit
- Mass – main measuring unit (adjustment unit)

Non-standard printout

- **Non-standard printout**

a printout may contain: TEXTS and VARIABLES (which are acquired from the software on printout).

Each non-standard printout is a separate project, featuring specific name, by which it is identified, and saved in the database of printouts.

PROCEDURE:

1. Press option <Non-standard printout>
2. Press <Add>  key
3. A window is opened with the following data: Name/Code/Project
4. Set name and code of a printout
5. Press <Project> key
6. A keyboard is opened on the display for editing the printout
7. Use keyboard to design printout template, the printout may contain texts and variables.

Caution:

- *User can add a printout by importing configured texts from data storage devices connected to moisture analyzer's USB port.*
- *Printout's name is ONLY a NAME, and it is not part of its content.*
- *Means of designing a non-standard printout template is described in point 19.10 <Printouts> of this user manual*

16.6. Profiles

Profiles are described in point 15. <Profile> of this user manual.

17. DRYING PROCESS – GENERAL INFORMATION

Working mode <  **Drying** > is dedicated to determining moisture content in a substance by its drying. On process start controlled by a user, the moisture analyzer checks loss of mass of a substance placed in the drying chamber. The substance sample is heated by a moisture analyzer, and on basis of mass decrement, the software calculates moisture content in a sample, and visualizes measurement result on the display. The drying result is continuously updated during drying process course, and the process is completed automatically on meeting finish mode requirements set by a user.

SAMPLE PREPARATION FOR DRYING

This section of the MA 3Y user manual contains data on setting optimum test results during drying processes. There are hints for selection of appropriate drying parameters for various materials and substances.

17.1.1. Means of moisture content measurement on a moisture analyzer

Measurement of moisture content in a tested sample is carried out by determining loss of mass in a sample by its heating (humidity evaporation from a sample).

RADWAG moisture analyzer MA 3Y series comprises two components: a precision balance and a drying chamber. Compared to standard moisture content determining methods, the measurements with application of RADWAG moisture analyzer is much quicker and does not require additional mathematical calculations (a result of moisture content is previewed on an ongoing basis during product testing process).

Independently on moisture content determining method, the measurement accuracy is highly influenced by means of sample preparation and selection of testing parameters, such as:

- Sample size
- Sample type
- Drying temperature
- Drying time

In practice, the measurement accuracy is not as important as the speed of obtaining measurement result (control over technological process). Thus, heating a sample (with application of a halogen filament) carried out by a moisture analyzer, makes the measurement process very time efficient and short. Measurement speed can be additionally increased by appropriate adjusting moisture analyzer's parameters depending on tested substances.

Optimum **temperature** and **drying time** depend on sample type and size, and anticipated measuring accuracy. **Selection of drying parameters can only be carried out on basis of test measurements.**

17.1.2. Sampling and preparation

Sample features, its preparation and size are very important factors influencing the speed and accuracy of measurement process.

Means of sampling and preparation are extremely important for repeatability of measurement results, as a sample should be a representative part of tested substance.

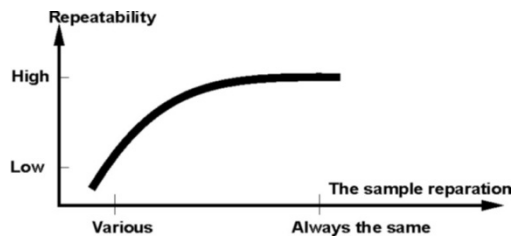

Final measurement result is vastly conditioned by precise and considered sample preparation. A sample used for analysis has to represent the total structure of tested material. Sampling process should determine: sampling means, sample disintegrating, particle size after disintegration, sample uniformity and other. The sampling process should be carried out as quickly as possible, so that a sample does not lose or absorb humidity from surrounding area.

Applied sampling standards should match individual user needs and requirements of tested material, its consistency and sample size.

Number of samples

Increasing number of tested samples also increases statistical measurement certainty. Number of samples depends on uniformity of tested material, its purity, accuracy of applied measuring method and anticipated accuracy of obtained results.

Material mechanical disintegrating for measurements

Applied disintegrating method should be selected appropriately to tested material. Substances that are hard and brittle (crisp) can be disintegrated by cutting. Grinding such substances may cause their heating and thus humidity vaporization, resulting in unreliable measurement results. Unless a substance can be prepared for measurement otherwise than grinding, any possible moisture content loss should be calculated.

Use of high-silica sand

Ensuring optimum substance drying requires that a sample has the largest possible surface for moisture content vaporization. Test results of moisture content in substance which surface has a form of a shell (e.g. glucose syrup) or doughy (e.g. butter), can be much more reliable if a sample is mixed with a dried high-silica sand (improvement of measurement accuracy and repeatability).

Grease in a form of paste or melting substances

Such substance requires testing with use of a filter made of glass fibre, which considerably increases active evaporation surface by separating the substance between the fibre. Initial filter drying is necessary only in case of measurements which require very high accuracy.

Liquid substances

It refers to liquid substances, which by creation of drops on their surface, caused by surface tension, may render difficulties in drying process. In such cases, it is proved to use a glass fibre filter to shorten measurement time. The filter causes separating tested liquid around the fibres, and increasing active

evaporating surface. Initial filter drying is necessary only in case of measurements which require very high accuracy.

Substances with structure of leather or temperature sensitive

In case of such substances it is proved to a glass fibre filter. While testing, a substance is placed on a drying pan, and sample surface is covered with a filter, which protects the sample from direct heat radiation. In such case, the sample is heated by convection (which is milder than radiation).

Substances containing sugar

The surface of such substances often may caramelize during testing procedure. Therefore, it is recommended to use thin layer of a sample, and moderate drying temperature.

SAMPLE PREPARATION

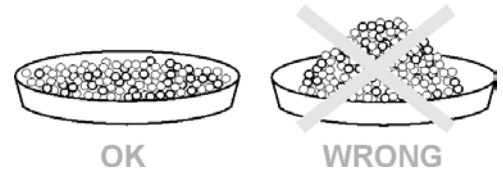

17.1.3. Sample distribution on drying pan:

Loose materials

Dried in their natural state, i.e. in their natural form or disintegrated. Sample disintegration causes smaller dispersion between the following measurements. Sample mass should not be too high, and the sample should be evenly spread on whole surface of the drying pan.

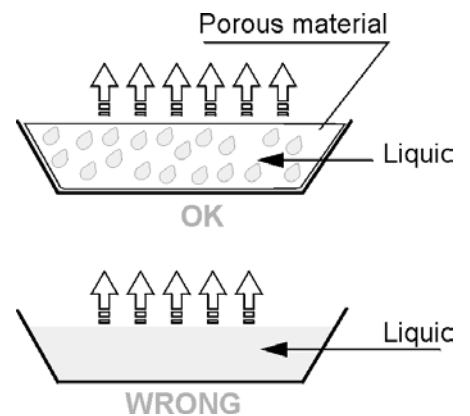

Liquid substances

Semi-fluid substances are dried in their natural form. Large amount of grease (fat) occurring in some of substances makes moisture content determination difficult. In such case it is recommended to use additional components, which increase sample's active surface and aid moisture content releasing process from a sample. Such components are high silica sand, blotting paper or filter. Before drying a tested substance, initially dry the additional component, so that its humidity is close to zero.

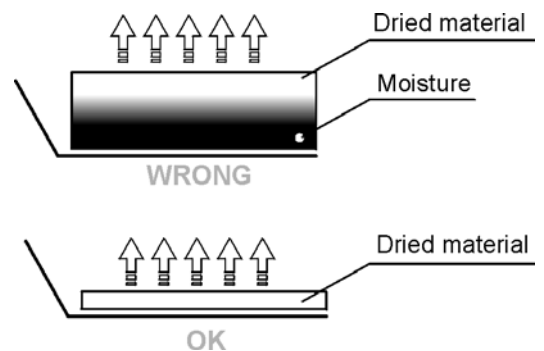

Solid objects

Depending on solid object's structure (dense or loose), moisture content determining process may take short or long time. The size of solid's surface determines the speed of drying process, and measurement reliability. Thus, the surface of a solid object should be as large as possible. Since solid objects release moisture through their outer surface, sample thickness is another important factor.

17.2. SELECTION OF DRYING PARAMETERS

17.2.1. Selecting optimum sample mass

Sample mass influences the accuracy of measurement result and measurement time. Higher mass of a sample, causes higher amount of water (moisture content) which needs to evaporate, and therefore measurement time is also longer.

Obtaining short measurement time is feasible in case of small sample mass, but sample mass cannot be too small, as it may negatively influence required measurement accuracy.

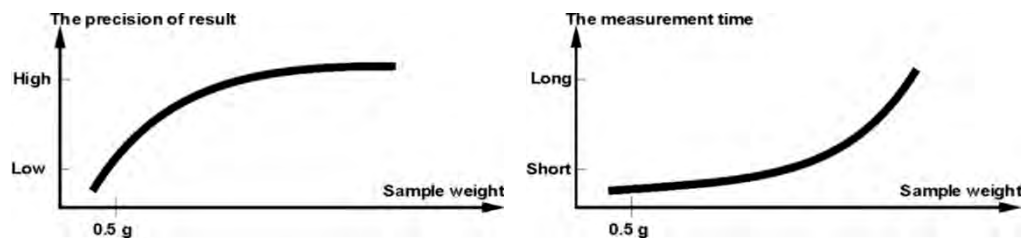

17.2.2. Influence of sample mass on measurement result repeatability

Sample mass considerably influences repeatability of measurement results obtained on a moisture analyzer. Relation between sample mass and repeatability is presented below.

Sample mass	Repeatability
to 2g	$\pm 0,24\%$
to 10g	$\pm 0,06\%$
Over 10g	$\pm 0,04\%$

The above data refers to a model, uniform sample, containing no moisture due to the evaporation process and showing no signs of decomposition (e.g. wet high-silica sand).

The results uncertainty cannot be avoided, this is due to sample nature and moisture analyzer repeatability. In practice, it means that obtained measurement result may exceed repeatability values provided above.

17.2.3. Drying temperature

Drying temperature has the largest impact on drying time. Temperature value depends on type of dried substance. Too low drying temperature causes too

low moisture content evaporation (under-dried sample), and consequently unnecessary extending of measurement time. Too high drying temperature causes burning of dried sample (sample overheating, chemical decomposition). Drying temperature of traditional method (using a furnace) is specified in applicable industry or company standards. Unless standards apply, then temperature should be adjusted by tests.

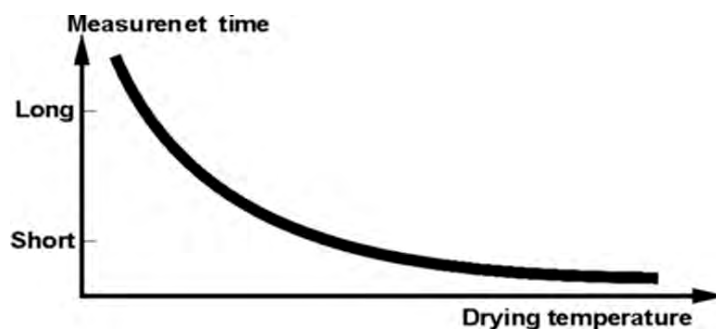

On selecting drying temperature value, proceed as follows:

- Determine moisture content in a sample
- Determine temperature of substance chemical decomposition by tests
- Compare result obtained on a moisture analyzer with the one of traditional method

When drying a sample with high moisture content, it is possible to shorten measurement time by selecting “quick” drying mode. In such case, the majority of moisture content is released drying temperature higher than set. Only after some time, the temperature is lowered to the set value, and maintained until completing drying process.

17.2.4. Selecting drying mode

The software of moisture analyzer MA 3Y series enables selecting one of four drying modes:

- Standard
- Quick
- Mild
- Step

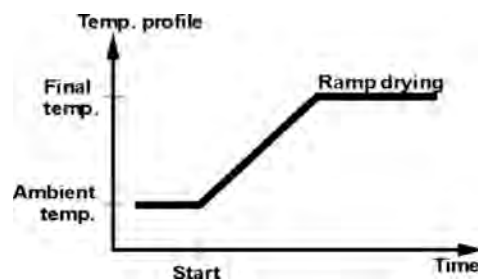
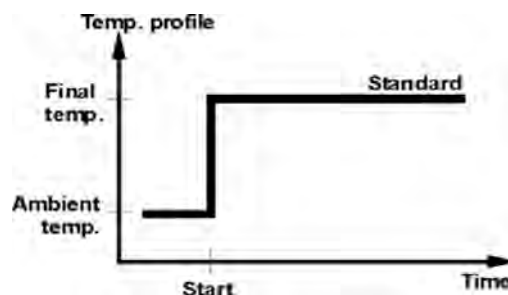

STANDARD mode

Standard mode is the most frequently used of all drying modes. It enables accurate determining of moisture content is a dried sample.

MILD mode

Mild mode is used in case of drying substances that are sensitive to rapid heat emitted by filaments operating at full power in the initial stage of drying process. This mode prevents from decomposing of substances sensitive to heat by mild temperature increase in set amount of time (time interval has to

be selected by tests). Mild mode is recommended to drying samples of leather structure.

QUICK mode

Quick mode is recommended to drying samples that moisture content varies from 5%, and 15%. In the initial stage of Quick mode, heating takes place at full power of the filaments, causing heating the drying chamber to increased temperature (maximum temperature value is higher by 30 % from set drying temperature). Overheating compensates heat loss during evaporation of large moisture content in the test's initial stage.

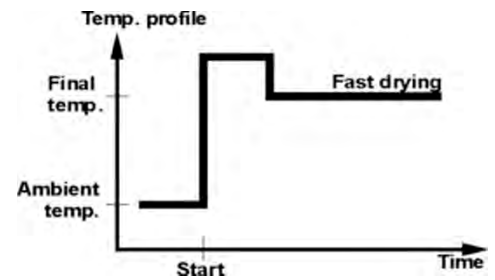

STEP mode

Enables determining up to three steps with random drying temperature. Step mode is recommended for drying substances with moisture content over 15%. Temperature and heating time in each step have to be adjusted by tests.

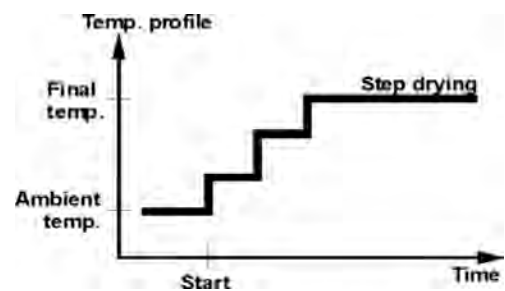

17.2.5. Drying time

Drying time is set by selecting one of available finish mode criteria. This means that a moisture analyzer must meet pre-set criterion (one of the requirements: mass over time, time) to automatically finish the drying mode.

Finish of drying process can be triggered by amount of time, independently on loss in mass. This criterion is used for substances that may decompose during drying process, and their mass does not reach constant value.

The second criterion is loss in mass (less than 1 mg) in defined amount of time.

Automatic finish mode (Auto switch off mode)

MA 3Y operator can choose between various types of finish modes:

- Automatic 1 (change 1mg/10s)
- Automatic 2 (change 1mg/25s)
- Automatic 3 (change 1mg/60s)
- Automatic 4 (change 1mg/90s)
- Automatic 5 (change 1mg/120s)
- Time defined (maximum drying time 99 hours 59 minutes)
- Manual (on pressing a function key)
- User defined 1 (set mass change ratio Δm 0,1-9,9mg and time interval Δt max 2,55 sec.

- User defined 2 (set moisture content change ratio $\Delta\%M$ over time 60s)
- Test (enables adjusting finish mode parameters to a tested sample)

Automatic finish mode – user defined criterion (mass/time)

MA 3Y operator determines the limit value for loss of mass and time in which the loss of mass must not exceed a pre-set value. As the moisture analyzer reaches the set criterion it automatically finishes the measurement (drying process).

Automatic finish mode – user defined criterion (change of moisture content)

An operator determines limit loss of moisture content over time of 60s. As the moisture analyzer reaches the set criterion it automatically finishes the measurement (drying process).

Manual finish mode



An operator ends drying process manually by pressing STOP soft key on moisture analyzer's display.

Time defined finish mode

Drying process finish takes place on elapsing a set amount of time, independently on measurement result.

18. DRYING PROCESS

18.1. Working mode activating procedure

- while in the main window, press  soft key located in the upper bar of the display, which opens a submenu <Working modes> with selection of available working modes,
- select  **Drying** > mode, the software automatically returns to the main window and displays  pictogram in the upper bar,

The grey coloured workspace contains the following data:

- Drying mode
- Product

On selecting the drying mode , the display contains the following quick access keys in the bottom bar:

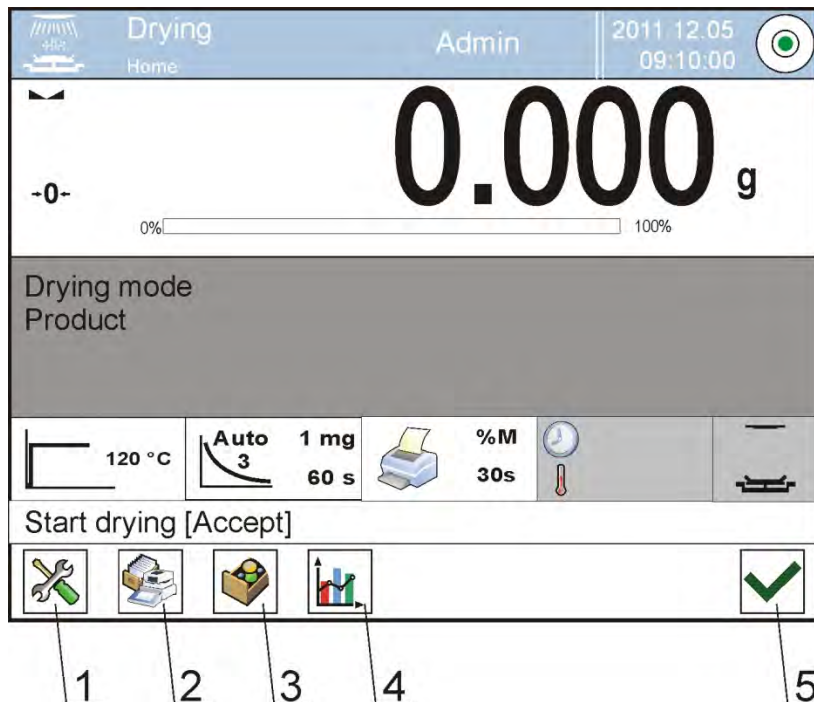

1. Setup – access to moisture analyzer’s menu
2. Database of drying programs – selection of drying programs
3. Database of products – selection of products from corresponding database
4. Drying chart – previewing chart from drying process (active during drying process only)
5. Start drying process

18.2. Setting drying parameters

Drying parameters are set as follows:



18.2.1. Using fields visible in the main display section

The option enables quick setting of each drying parameter, with no need to enter menu options. An operator gets access to drying parameters on pressing an active field on the touch screen display.

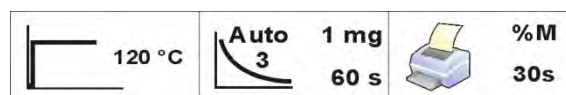
There are three basic fields:

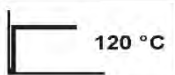

1	This field enables setting drying mode and parameters related to selected mode.	
---	---	---

2	This field enables setting finish mode criterion, and its parameters (depending on selected option).	 Auto 3 1 mg 60 s
3	Field enables setting type of data previewed on the display during drying process, and printed on a connected printer. It also enables setting printing time interval of moisture content value in dried product.	 %M 30s

CAUTION:

Option disabled if active drying profile is selected from database of drying modes/programs.

DRYING MODE

Select and set drying mode parameters by pressing dedicated soft key on moisture analyzer's display.

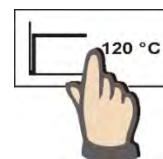

After pressing, a new window is opened for determining drying mode. Select one of available drying modes by pressing field with its name.

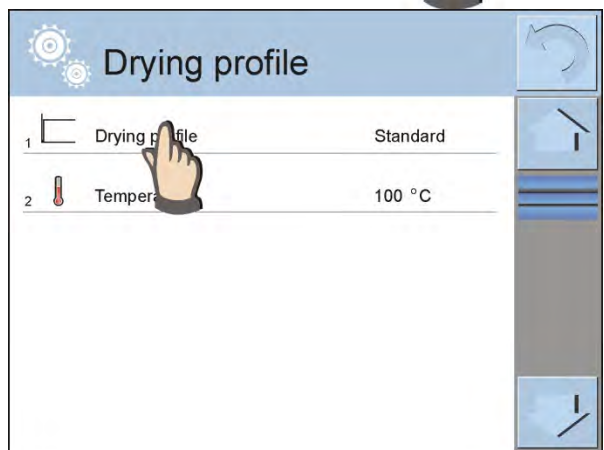

A window for selecting drying mode is opened.

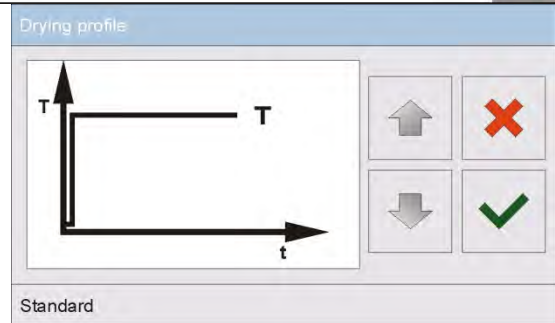

Use navigating arrow keys to scroll through available modes.

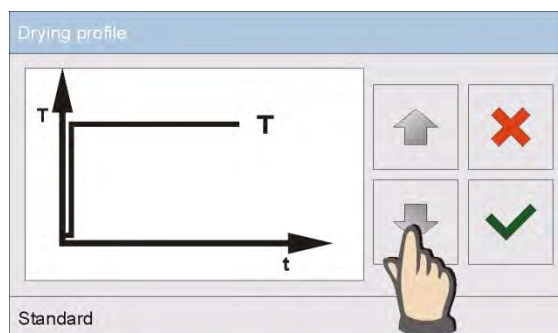

After selecting desired mode, accept the choice.

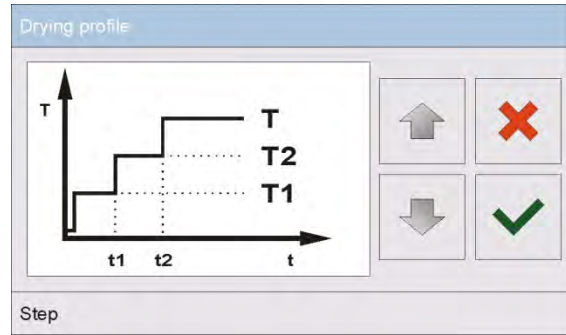

The software returns to displaying the previous window, and displayed data refer to selected drying mode. Set drying parameters to user needs by pressing a field with parameter name, which opens for editing.

The figure shows the main 'Drying profile' window. It features a list of six parameters, each with a corresponding icon (thermometer for temperature, clock for time). A hand icon is shown pointing to the 'Temperature 1' field. The window includes a settings gear icon, a refresh button, and a list icon on the right side.

Step	Parameter Name	Value
1	Drying profile	Step
2	Temperature 1	50 °C
3	Time 1	0:03:00
4	Temperature 2	80 °C
5	Time 2	0:03:00
6	Temperature 3	120 °C

An instance of window for editing drying temperature value. Insert desired drying temperature value for particular thresholds using the on-screen numeric keyboard, and accept entered value.

The figure shows a 'Temperature [°C]' editing window. It features a text input field containing the value '100'. Below the input field is a numeric keypad with buttons for digits 0-9, a decimal point, a minus sign, left and right arrows, and a 'Back' button. There are also 'cancel' (red X) and 'confirm' (green checkmark) buttons.

An instance of window for editing drying time. Insert desired amount of time using the on-screen keyboard, and accept entered value.

The figure shows a 'Time hh:mm:ss' editing window. It features a time input field displaying '00 : 03 : 00'. Below the input field is a numeric keypad with buttons for digits 0-9, a decimal point, a minus sign, left and right arrows, and a 'Back' button. There are also 'cancel' (red X) and 'confirm' (green checkmark) buttons.

After setting basic drying parameters return to the main window of the drying mode. A pictogram on the main display indicates data with selected drying profile and set temperature values.

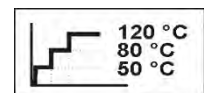

ATTENTION:

For the fast and step mode the drying time in overdrive temperature (step mode) or particular thresholds (fast mode) should be set. The time is counted from the moment of reaching the temperature for the particular threshold. (Use only when applicable).

FINISH MODE

Select and set finish mode parameters by pressing dedicated soft key on moisture analyzer's display.

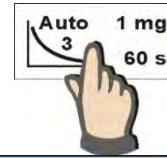

After pressing, a new window is opened for determining finish mode. Select one of available finish modes by pressing field with its name.

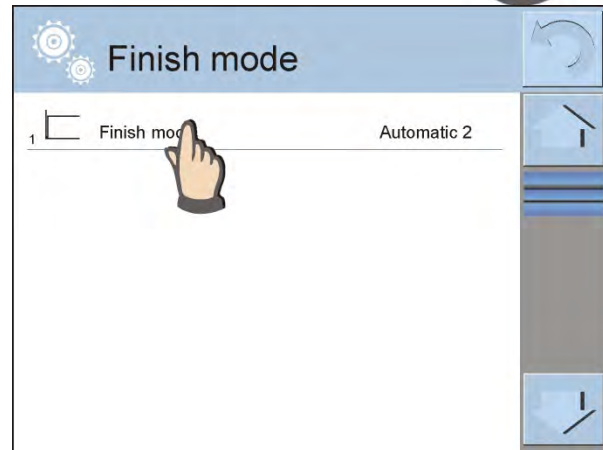

A window for selecting type of finish mode is opened. Use navigating arrow keys to scroll through available modes.

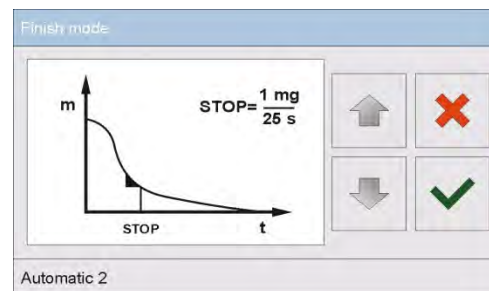

After selecting desired mode, accept the choice.

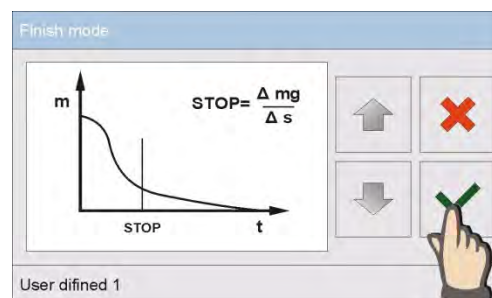

The software returns to displaying the previous window, and displayed data refers to selected finish mode. Set parameters to user needs by pressing a field with parameter name, which opens for editing.

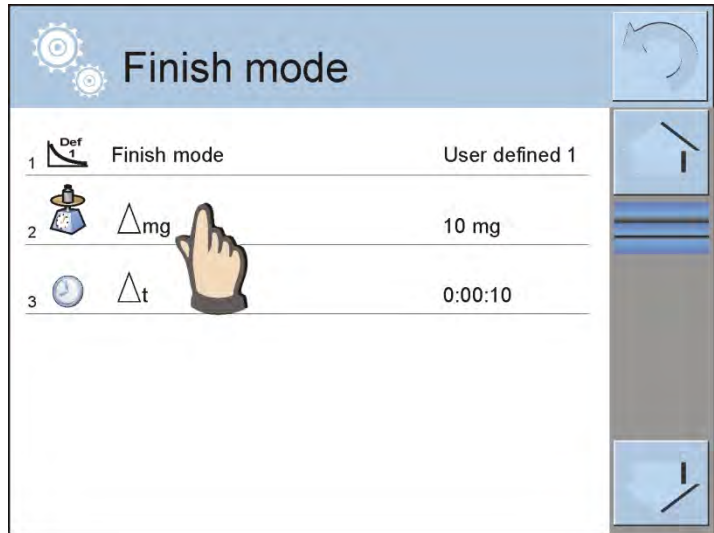

An instance of window for editing mass change ratio. Insert desired mass value using the on-screen numeric keyboard, and accept entered value.



An instance of window for editing time. Insert desired time value using the on-screen numeric keyboard, and accept entered value.

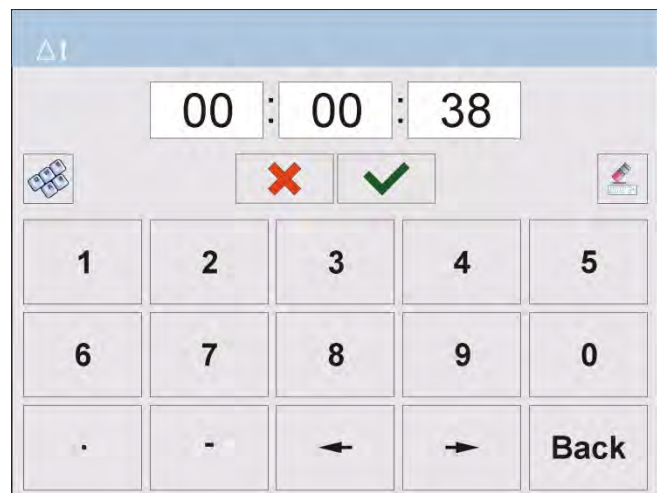

After setting the finish mode parameters return to the main window of the drying mode. A pictogram on the main display indicates data with selected finish mode settings.

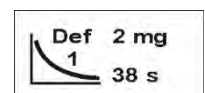

PRINTOUT

Select and set parameters of printout and printing interval by pressing dedicated soft key on moisture analyzer's display.

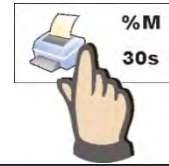

After pressing, a new window is opened for determining printed parameter and printing interval. Press field with parameter name to change its value.

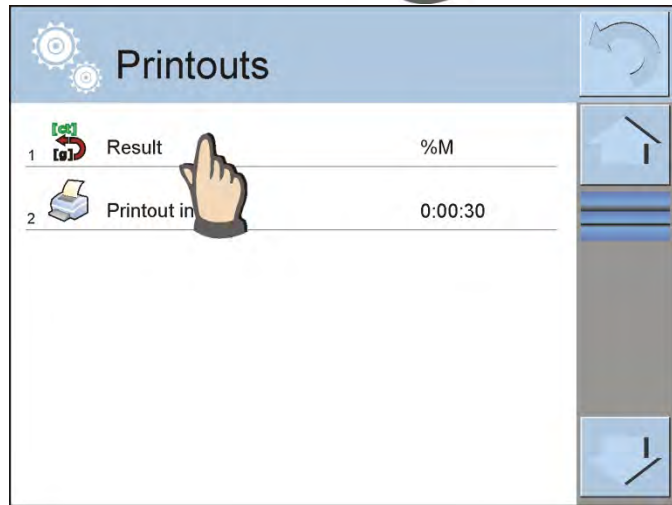

A new window is opened for selecting measuring unit. Use navigating keys to select desired unit for measuring drying process.

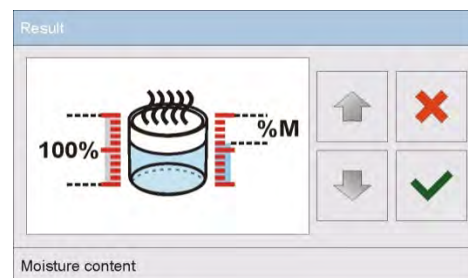

On selecting a desired unit, accept it.

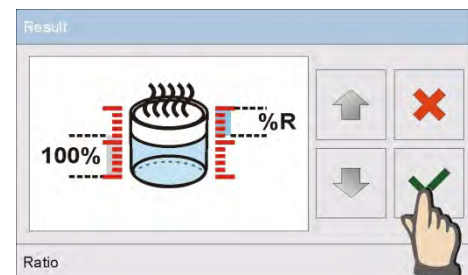

An instance of window for editing printout time interval. Insert amount of time using the on-screen numeric keyboard, and accept entered value.



After setting printout parameters return to the main window of the drying mode. A pictogram on the main display indicates data with selected printout parameters.



18.2.2. Use of menu <Settings>

After entering the moisture analyzer settings, the user can define all drying parameters, and main data for printing completed measurements (data type, time interval between printing the following measuring data). The data is definable in one menu window.

Procedure:

1. Press grey coloured workspace
2. Moisture analyzer's display indicates menu: Settings, Keys, Information, Printouts, Profile,
3. Press <Settings> key,
4. The display indicates functions related to drying mode, such as:
 - **Drying mode** [means of heating a sample]
 - **Finish mode** [criteria on finishing drying process]
 - **Result** [moisture content measuring unit, active on drying process start]
 - **Printout interval** [time intervals in which measurement data is printed]
 - **Start mass control** [enabled / disabled – meeting a requirement of determined start mass of a sample, with declared tolerance of this mass value (setting mass value and its tolerance is carried out in database of products)]
 - **Print measurements** [printing indirect measurement result of moisture content determining process, with time interval set in parameter <Measurement time >]

Means of setting each parameter is the same as in case of the previous menu option. The only difference refers to possibility of declaring parameter of controlling start mass for a sample.

This parameter determines use of a sample with specific mass to test its moisture content.

CONTROL OF START MASS enables setting one of three options:

No – option disabled, mass of a sample prepared for drying is not controlled by the software

Optional – option enabled, the display shows a bar graph demonstrating graphic visualization of sample mass in relation to mass value saved in the database of products. It is a sample mass and its tolerance limits set in the software.

Before applying this option, add a product in the database, including data on sample mass and its checkweighing limits.



On enabling this option, the moisture analyzer's software displays commands on placing a sample with determined mass on the drying pan. However, if a user decides otherwise, then a moisture analyzer starts drying process even if sample mass exceeds determined threshold limits for a tested sample mass.

Mandatory - option enabled, the display shows a bar graph demonstrating graphic visualization of sample mass in relation to mass value saved in the database of products. It is a sample mass and its tolerance limits set in the software.

Before applying this option, add a product in the database, including data on sample mass and its checkweighing limits.

On enabling this option, the moisture analyzer's software displays commands on placing a sample with determined mass on the drying pan. Unless the sample mass is within set threshold limits, the software does not allow to start drying process.

There are two ways of using this option:

1. For an optional product, using quick access keys:  **Checkweighing thresholds**> or  **Target value**>.
2. In combination with a specific product saved in the  **Database of products**>.

In the 1st case, the target value, checkweighing thresholds and percent tolerance of mass should be set using quick access keys.

In the 2nd case, the value of mass, and tolerance fields have to be specified their corresponding fields of the <Database of products>.

SETTING TOLERANCE LIMITS FOR SAMPLE MASS:

MIN and MAX THRESHOLDS: the software accepts sample mass as correct, if it is within set value of MIN and MAX thresholds (MIN and MAX criteria are set in the database of products).

TOLERANCE: the software accepts sample mass as correct, if it is within set percent tolerance limits of total sample mass ($\pm\%$) - (data set in the database of products).

Before starting drying process, a user should declare parameters of a sample which is loaded on the drying pan: MIN and MAX, target mass and percent tolerance of sample mass. On setting above criteria the software allows for beginning the drying process.

1. Defining the value of Min/Max thresholds is carried out in the Database of Products during editing a Product or by using quick access key  **Checkweighing thresholds** >.

Procedure:

- Press grey coloured workspace, and then <Keys> option

- Assign <Checkweighing thresholds> option to one of the quick access keys displayed in the bottom bar
- Return to drying mode
- Press  <Checkweighing thresholds> soft key and insert the value of Low Threshold and High Threshold. Return to drying mode.
- After displaying <PREPARE SAMPLE> command, the display, below the measurement result, indicates a bar graph, which using colours shows current mass on the drying pan.
- Yellow colour – current mass below set Low Threshold value
- Green colour – current mass within set thresholds values
- Red colour – current mass above set value of High Threshold

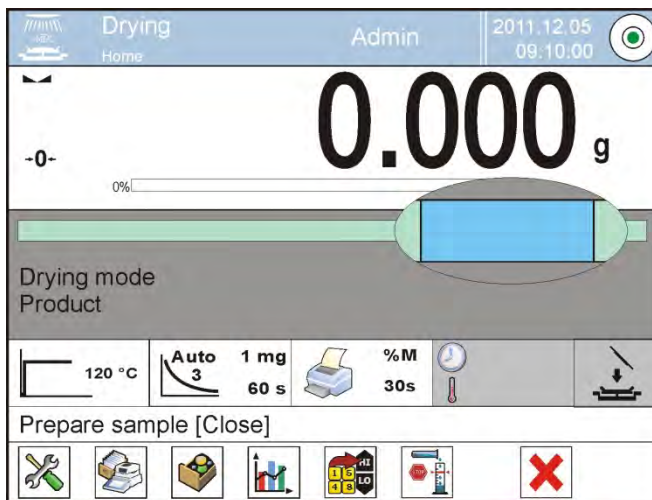

2. Defining the value of target mass is carried out using a quick access key

<  Target mass >

Procedure

- Press grey coloured workspace, and then <Keys> option
- Assign <Target value> option to one of the quick access keys displayed in the bottom bar
- Return to drying mode
- Press <  Target value > soft key and insert mass to be obtained in measuring process,
- Then, insert +/- percent tolerance of the target mass, (accessible range 0 – 100%)
- The display, below the measurement result, indicates a bar graph which contains:
 - Current mass (visualized with colours)
 - Target Mass value (visualized with black marker)

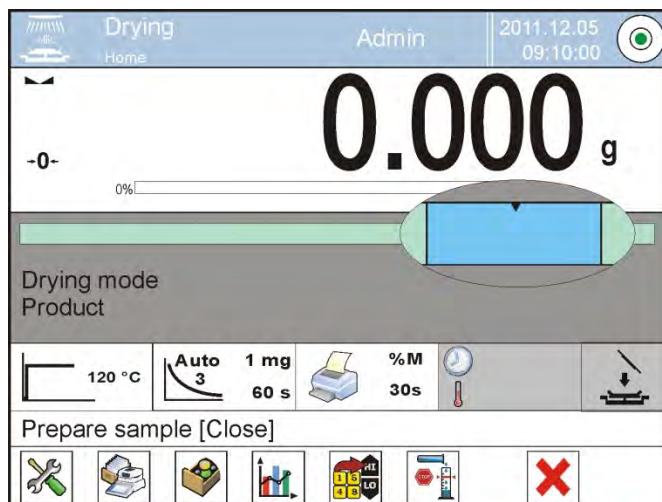

Caution:

The checkweighing thresholds and target mass options may function simultaneously during drying process. In such case, the tolerance field is realized by Min and Max thresholds, and the bar graph indicates target mass marker.

On entering the database and selecting a product, which has the target mass value and Min & Max thresholds assigned, the software, while controlling the start mass, will first consider the Min and Max thresholds. The values of Min and Max thresholds can be changes before drying process using quick access keys displayed in the bottom bar. New values are accepted are instantaneous, and they are not saved in the product record in a corresponding database.



18.2.3. Using database of drying programs

Drying procedure can be carried out with use of a program saved in the <Database of drying programs>.

Adding a program to the Database of Drying Programs

Database of drying programs contains saved drying procedures, which are easily recalled before drying a sample. Adding procedure functions easily and very intuitively, and a user has to follow commands and hints that appear on moisture analyzer's display.

Procedure:

- Enter submenu < Databases>, and press < Database of drying programs>
- Press < Add > key to add a new program to the database

The software automatically adds a new entry to the database and immediately enters its editing mode. Fill in all mandatory parameters on a new drying product.

List of data definable in a drying program:

1. **Name:** on pressing the name field, a new window is opened for entering name of a drying program
2. **Code:** enables inserting a code denoting the drying program
3. **Drying mode:** on pressing the field name, a new window is opened with programmable drying mode. Proceed as in above points, and select appropriate drying mode, and specify drying parameters (drying temperature, time)
4. **Finish mode:** on pressing the field name, a new window is opened with programmable finish mode. Proceed as in above points, and select appropriate finish mode, and specify finish parameters (mass, time)
5. **Result:** on pressing the name field, a window with foldable list of available drying results is opened. Select one of available options, that should be displayed and printed during drying process. The software returns to displaying a window with drying program data.
6. **Printout interval:** on pressing the field name, a new window with numeric keyboard is opened. Proceed as in above points, and insert time value for printing intervals of the following measuring data during drying process.
7. **Start mass control:** on pressing the field name, a window is opened with a list of available options. Select one of them: **No, Optional, Mandatory**. The software returns to displaying a window with drying program data.
8. **Equipment related to a sample:** on pressing the field name a window with on-screen keyboard is opened for entering the required equipment needed for correct carrying out the drying process, e.g. a need to use a filter made of glass fibre.
9. **Sample preparation:** on pressing the field name a window with on-screen keyboard is opened for entering data on sampling and preparing processes, and recommendations for sample distribution on the drying pan.
10. **Recommended sample size:** on pressing the field name a window with on-screen keyboard is opened for entering the size of a sample to be dried as set using experimental tests.

After inserting all data on a drying program, return to the main window of the drying mode.

18.3. Printouts in drying mode

Option Printouts enables setting the contents of printouts in a standard printout and also determining non-standard printouts.

- **Standard printout**

comprises three internal sections featuring different variables. For each variable set option YES to include it in a standard printout. If option NO is selected, then the variable is disabled, i.e. it is not printed.

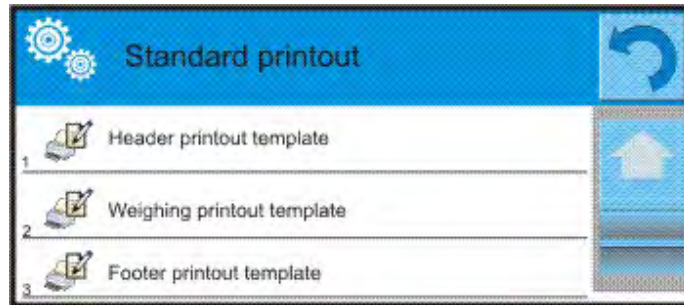

PROCEDURE:

1. Press field with name of a template to be edited (Header – Weighing – Footer) and select variables to be printed
2. If a printout is a non-standard one, create it

Drying mode is related to a report from drying process. A report contains all data available on a printout of: header, weighing and footer. It means, that each report printed during drying process, and saved in the database of drying reports has format as specified by a user.

CAUTION:

Data contained on a report for each measurement are set in option: <Weighing report template>. Each time on releasing a printout according to set time intervals, data which is printed is the one attributed <YES> in the < Weighing report template >.

Content of each printout section:

- **HEADER**
 - Dashes
 - Working mode
 - Start date
 - Start time
 - Balance type
 - Balance ID
 - User
 - Product
 - Drying program
 - Drying mode
 - Finish mode
 - Finish mode parameters



- Unit
- Printout interval
- Universal variable 1 ... 5
- Initial mass
- Empty line
- GLP report
- Non-standard printout

○ WEIGHING

- Dashes
- Date and time
- Drying time
- Product
- Current result
- Drying time and result
- Net
- Tare
- Gross
- Supplementary unit
- Mass
- Set temperature
- Current temperature
- Empty line
- Non-standard printout



○ FOOTER

- Dashes
- Working mode
- Status
- End date
- End time
- Drying time
- Balance type
- Balance ID
- User
- Product
- Universal variable 1 ... 5
- End mass
- Current result
- Dashes
- Empty line
- GLP report
- Signature
- Non-standard printout



18.4. Report from completed drying process

On completing each drying process a report is generated. The report is

saved in the database <  **Drying reports**>. The files are named by their date and time (hour) of carried out process.

An instance of a report from drying process:

```
-----  
Start date           2012.06.25  
Start time          14:41:55  
User                Admin  
Product             Tea  
Drying mode  
Drying profile      Standard  
Finish mode         Automatic 3  
Start mass          ? 0.386 g  
0:00:30             1.295 %M  
0:01:00             0.777 %M  
.  
.  
.  
0:06:00             1.295 %M  
-----  
Status              Completed  
End date            2012.06.25  
End time            14:48:05  
Drying time         0:06:10  
End mass            0.381 g  
Current result      1.295 %M
```

Signature.....

18.5. Means of carrying out drying process

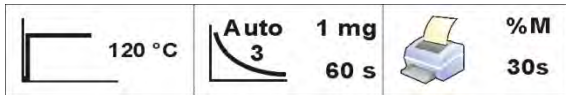

Bottom section of moisture analyzer's main display features three pictograms, which indicate current drying mode settings.



If these parameters are incorrect, they should be changed in a way, that are correct for a dried sample that is tested.

Means of setting drying parameters is described in the previous point of this user manual.

If drying process is based on a drying program from the database, then:

- Enter submenu <  Databases >, and press <  Database of drying programs >
- Select drying program by pressing field with its name. The moisture analyzer returns to displaying the main window. The grey coloured workspace indicates name of selected drying program, and pictograms on drying parameters indicate data of enabled drying program.
- On enabling a drying program, the drying settings cannot be changed. Drying parameters can only be changed if no drying program is enabled.
- An additional option is displaying (in an enabled drying program) descriptions on additional equipment needed for correct carrying out the drying process, sample preparation and recommended sample size. Using the options requires pressing the <Sample description> button in the bottom bar which opens a window with descriptions entered for the drying program.

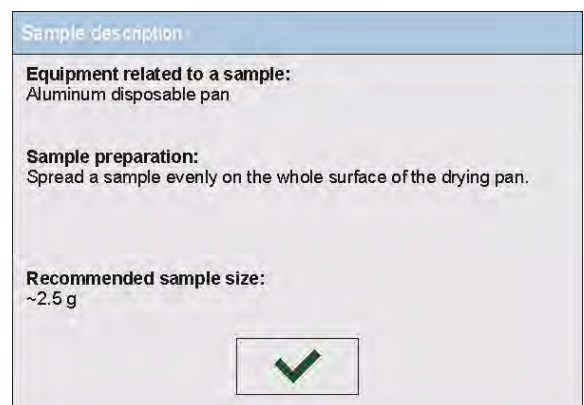
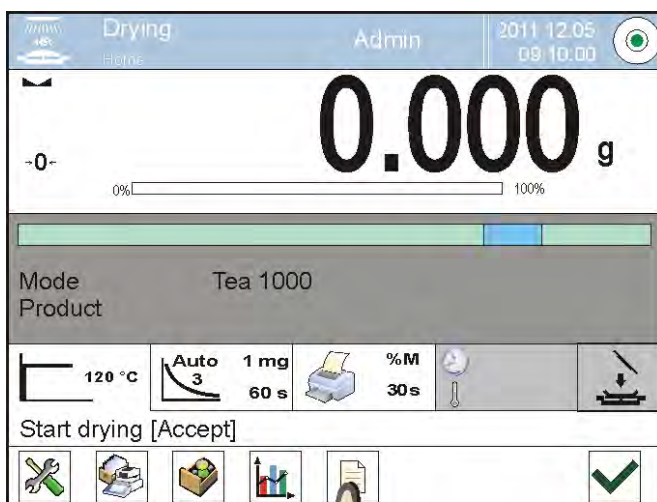

Caution:

The option is available only on selecting an optional drying program from the <Database of drying programs >.

If drying parameters are correct, a user can proceed to testing process.



Press  key to start drying process.

The software of a moisture analyzer displays commands aiding its operation and functioning. A user should follow displayed commands. This means ensures correct sample preparation for drying, and correct moisture content analysis of a sample.

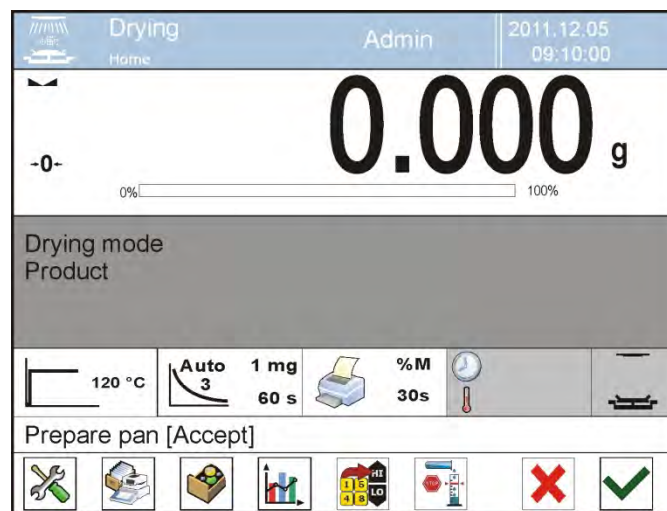

The software displays a command to prepare a drying pan.

Place the a disposable pan on a dedicated holder and assembly it on the cross-shaped holder in the drying chamber.

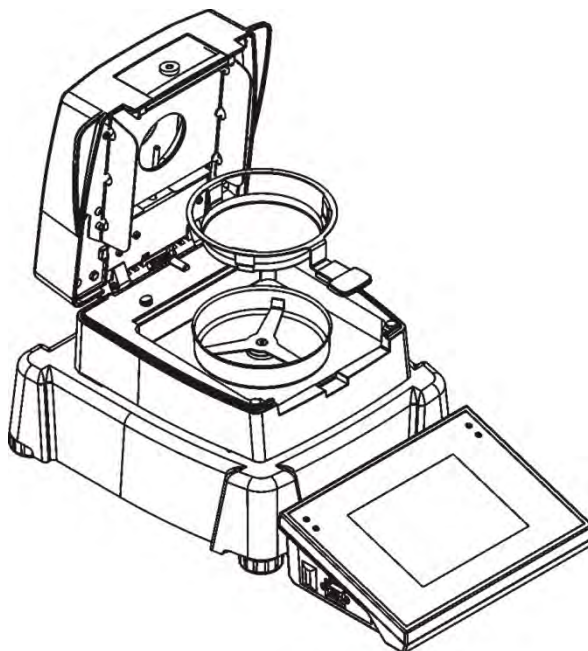

The display indicates initial mass of tested sample. In order to ensure stable measurement conditions, it is recommended to close the drying chamber's lid before tarring the indication.

Press  key to tare drying pan mass, and save its mass in moisture analyzer's memory.

Mass indication returns to ZERO and the following command is displayed.

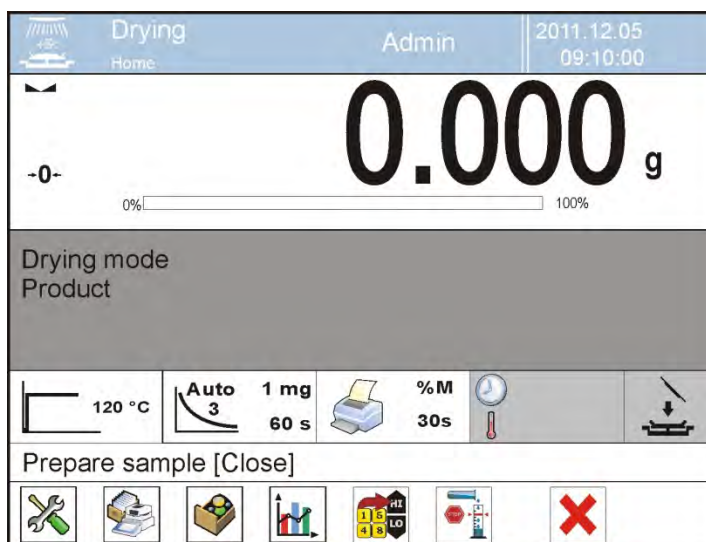

If <START MASS CONTROL> option is enabled, at this moment the display activates a bar graph indicating current sample mass in relation to saved Min and Max limits for sample's mass.

Load tested sample onto the drying pan. Select sample's mass according to previously carried out tests and characteristics of tested substance / material.

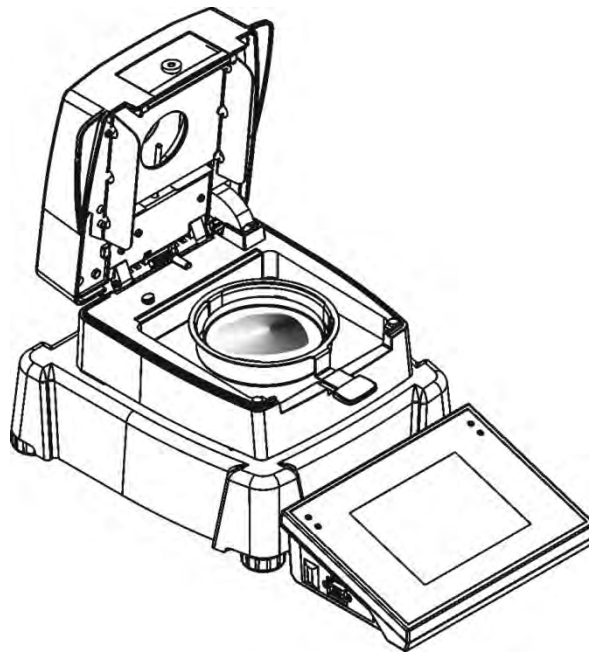

On stabilization of measurement result (indicated by stability pictogram on terminal's display) close the weighing chamber's lid.

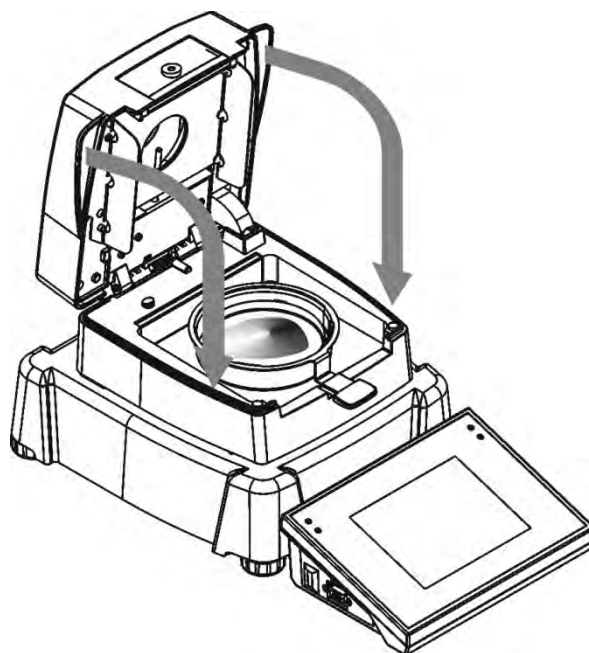

The software automatically starts drying procedure. The moisture analyzer starts drying process according to pre-set parameters and the display indicates data on carried out process. During the drying process the moisture analyzer carries out all necessary mass measurements and calculations resulting from mass change, and sends a header to a specific communication port (compatible with settings of printout options).

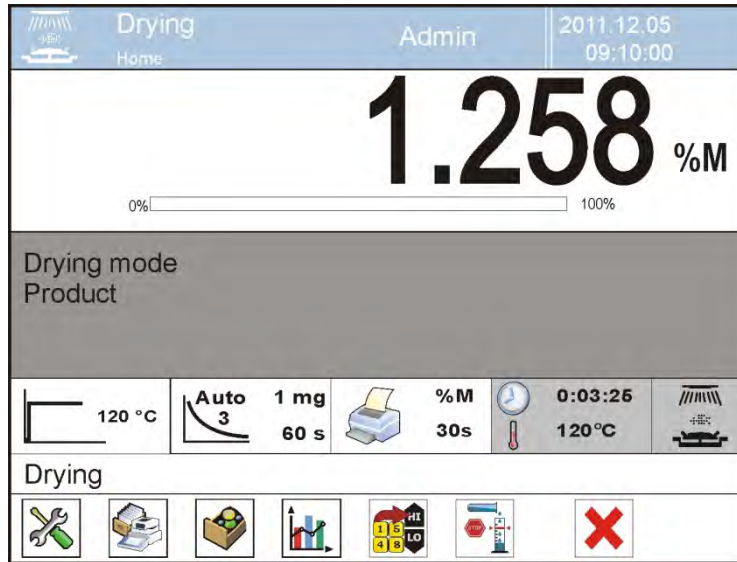

During drying process, the display shows instantaneous measurement results and data on the testing process (testing time, temperature in the drying chamber, etc.)

During drying process the software continuously sends instantaneous measurement results to a communication port (compatible with settings of printout options).

User can change previewed measuring unit during drying process by pressing a field with displayed unit, which opens a window with available units. On selecting a unit the software automatically calculates current display indication to the one of enabled measuring unit.

Drying process can be abandoned at optional moment by pressing STOP key. On finishing the drying process, the display previews test summary, and the final result of moisture content measurement is locked on the display.

The moisture analyzer sends a printout footer (compatible with settings of printout options) to a specific communication port.

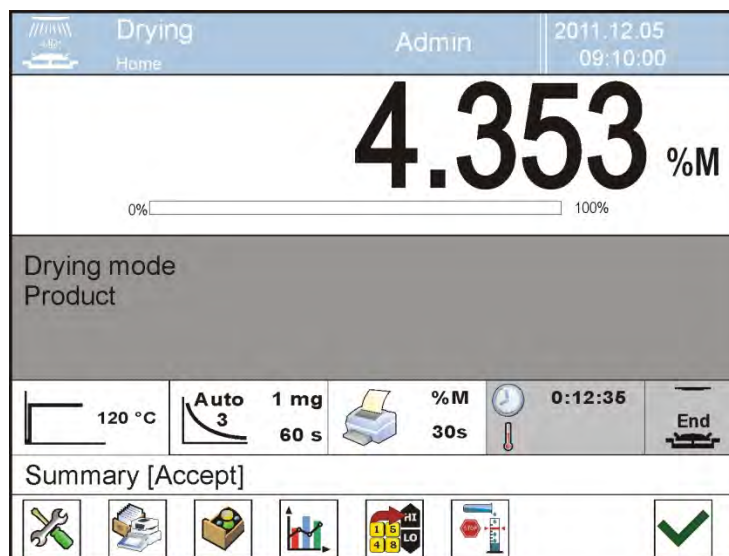

In order to finish the process press  button. The moisture analyzer returns to displaying the main window.

After removing the dried sample from the drying chamber, the user can start another drying process.

Remember that immediate starting an another drying process of a sample may result in distortion of moisture reading caused by evaporation of sample moisture if placed in a hot drying chamber before starting the drying process. Therefore, it is recommended to make a break between the following drying processes, needed for cooling down the drying chamber.

18.6. Chart of drying process

A user can preview drying process during either during its progress or after its completion by entering the <Database of drying reports>.

Previewing a chart during drying process in progress.



To preview a chart during drying

process, press  Chart> soft key in the bottom bar of the display.

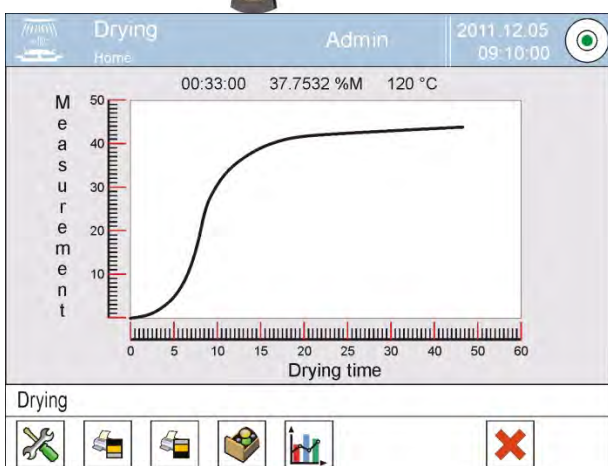

The software opens a chart including data on currently carried out process. The chart is created on the real time of the test course. It enables real-time monitoring of the process.

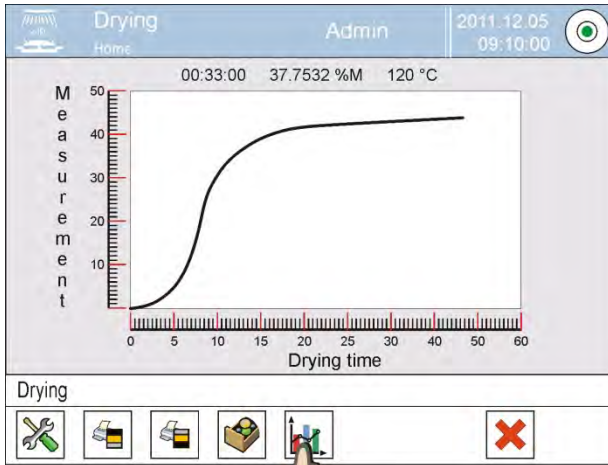

In order to view a chart with a different measuring unit, before enabling a chart a user should change active unit of moisture content analysis, and only then enable a chart using dedicated bottom bar soft key.



In order to return to the main window of drying mode, press <  Chart > soft key for the another time.

Previewing a chart in the database of drying reports.

Procedure



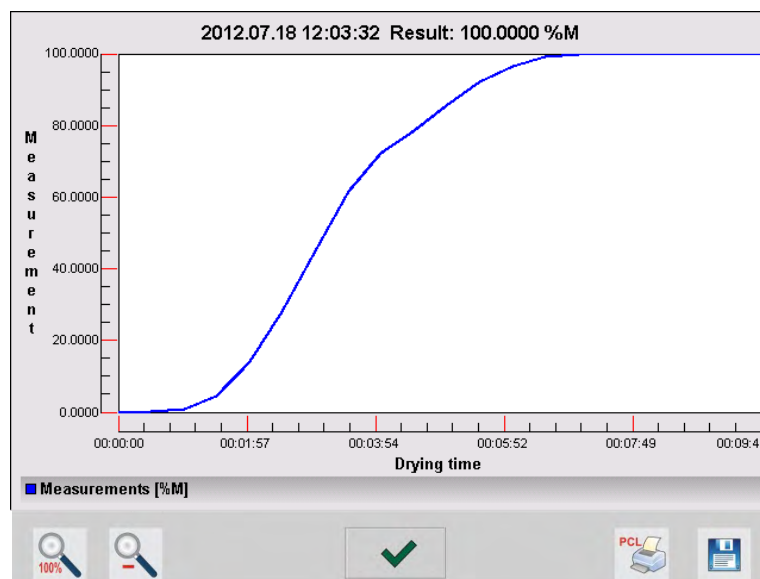

- Enter submenu <  Databases >
- Press <  Reports from drying process > field
- Select a report containing data on a desired drying process, and press its name (name of a report is its date and time of report creation)
- Press option <  Chart >

The software automatically generates and opens a report in the coordinate system of moisture content unit / measurement for completed moisture content analysis.

An instance of a chart from completed moisture content analysis for a sample, from a record saved in the database of drying reports



The bottom bar contains the following soft keys (options):





	Return to displaying the complete chart
	Reducing the screen to the previous view
	Return to displaying the previous window
	Printing the chart on a connected printer PCL type
	Saving the chart as a file in format <i>*.bmp</i> on an external data storage device connected to terminal's USB port.

19. DATABASES

Software of moisture analyzer MA 3Y series features the following databases



		
PRODUCTS	WEIGHING RECORDS	CLIENTS
		
DRYING PROGRAMS	REPORTS FROM DRYING PROCESSES (DRYING REPORTS)	STATISTICS FROM DRYING REPORTS
		
MINIMUM SAMPLE WEIGHTS	AMBIENT CONDITIONS	PACKAGES

 WAREHOUSES	 PRINTOUTS	 UNIVERSAL VARIABLES
 DATABASES MANAGEMENT		

19.1. Processes carried out on databases

Only authorized operator is entitled to carry out operations on databases.
To edit database the operator must:

- Press and hold a demanded database button
- Wait to see a corresponding menu
- Select one of possible options (available options depend on a database type)



Options:

- OPEN – allows to enter selected database (functions like single click of a given database icon)
- IMPORT – allows to import data form a memory stick. Plug the memory stick to an USB port to let the program detect it and open an appropriate window with saved files. Select a desired file to import demanded data. The process of copying starts automatically upon selection of the given file. Window with an appropriate message and file name is displayed after the data has been copied. Confirmation is required.

- EKSPORT – allows to export data from a database to a memory stick. Plug the memory stick to an USB port to let the program detect it and start a copying process. Window with an appropriate message and file name is displayed after the data has been copied. Confirmation is required.
- INFORMATION – displays information about database content (see the picture below).

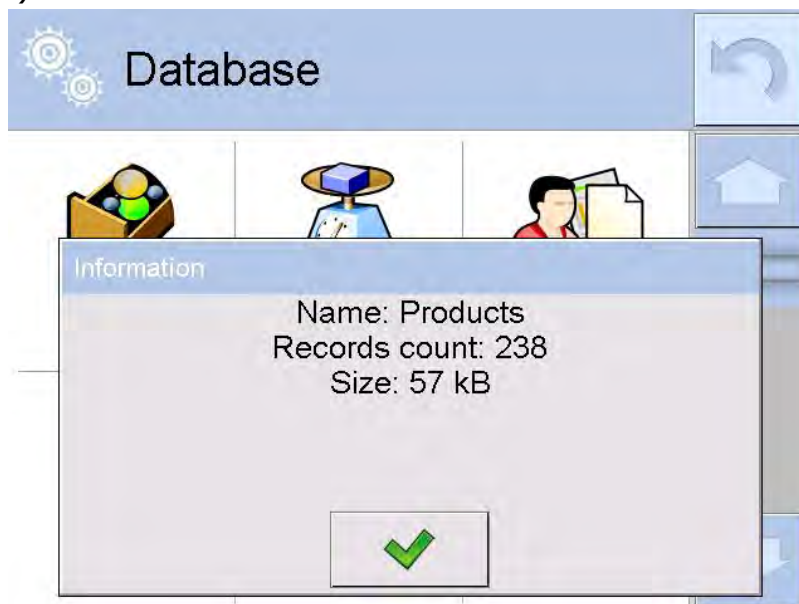







Upon confirmation the operator gets back to the previous window.

- CANCEL – returns to the previous window.

Databases <  > are accessed by pressing  key or corresponding quick access key in the bottom bar.

The following processes can be carried out in almost any of databases:



1. Adding entry to a database <  >
2. Searching for a record in a database by name <  >
3. Searching for a record in a database by code <  >
4. Searching for a record in a database by date <  >
5. Exporting database content to a data storage device through USB port
<  >
6. Printing data on a specific record from a database <  >

The above processes are carried out by pressing dedicated soft keys located in the upper right corner of the display. Follow hints and commands displayed by the moisture analyzer's software.

19.2. Products

Database of products contains names of all products that are weighed or dried.

Procedure

- Enter submenu < Databases>, and press < Products> field
- Press <  Add > key to add a new product to the database
- If a product already exists in the database of products, press field with its name

List of parameters defined for a product:

1. Name
2. Description
3. Product code
4. EAN code
5. Mass [unit mass of a product]
6. Min [minimum start mass of a sample, that is recognized by the software as correct if option <START MASS CONTROL – LO> is enabled]
7. Max [maximum start mass of a sample, that is recognized by the software as correct if option <START MASS CONTROL – HI> is enabled]
8. Tolerance [% value calculated in relation to mass (5), denoting measuring area in which the measurement is recognized as correct. Enabled if option <START MASS CONTROL> is active]
9. Tare [product's tare value, set automatically on selecting a product from the database]
10. Price [Unit price of a product]
11. Density [product's density, used for compensating air buoyancy, as sample density] - [g/cm³]
12. Shelf-life time in days
13. Date [Set product's date (constant)]
14. VAT [VAT value related to a product]
15. Ingredients [Editing field for inserting names of ingredients used for preparing a product, e.g. if a product is a mixture, or if a product requires additional description of its features or application]
16. Printout [printing a template assigned to a product]

19.3. Weighing records

Each measurement result sent from a moisture analyzer to a printer or a computer is saved in the database of weighing records.

Moisture analyzer user can preview data from each weighing record.

Procedure:

- Enter submenu < Databases>

- Enter database of <  **Weighing records** > and press desired entry (record).



List of parameters on a weighing record saved in the database:

1. Measurement date
2. Measurement result
3. Tare value
4. Determination of measurement status (stable / unstable)
5. Product name
6. User
7. Client, Client name
8. Working mode name
9. Warehouse, name of source warehouse
10. Packaging, name of tare applied during product's weighing process
11. Result control, information on threshold in which the weighed product was placed:
MIN – below LOW threshold (possible only if <Result control> is set to NO>)
OK – between the LOW and HIGH thresholds,
MAX – above HIGH threshold (possible only if <Result control> is set to NO>),
12. Weighing platform no., field denoting number of a weighing platform (moisture analyzer / balance / scale) on which a measurement was carried out,
13. Leveling, demonstrates if level status was maintained during measurement,
14. Ambient conditions alerts, demonstrates if temperature and humidity were stable during measurement

19.4. Clients

Database of Clients contains name of Clients for whom the measurements are carried out.

Procedure

- Enter submenu <  Databases >, and press < Clients > field
- Press <  Add > key
- If a client already exists in the database of clients, press field with its name

List of parameters defined for a client:



1. Client name
2. Client code [internal code identifying a client]
3. VAT no. [tax identification no.]
4. Address
5. Postal code
6. City
7. Discount

8. Printout [type of printout, label declared to a client]

19.5. Drying program

Database of drying programs contains saved data on drying parameters which are activated to dry a product.

Procedure

- Enter submenu < Databases>, and press < Drying programs> field
- Press < Add > key to add a new program /profile to the data of drying programs
- If a program already exists in the database of drying programs, press field with its name to enter its editing mode.

List of parameters defined for a drying program:



1. Name
2. Code
3. Drying mode
4. Finish mode
5. Result
6. Printout interval
7. Start mass control
8. Equipment related to dried sample
9. Sample preparation
10. Recommended sample size

Parameters 8 to 10 are informative ones for informing a user on additional requirements needed to dry a product (e.g. using a filter made of glass fibre, using specific sample mass or means of preparing a sample for drying). The descriptions are enabled on pressing one of the quick access keys <Sample description> and enabling one of available drying programs.

19.6. Reports from drying process (Drying reports)

Database of drying reports contains data on completed analysis of moisture content in a tested sample. Each report can be previewed, searched by date, exported or printed.

Procedure

- Enter submenu < Databases>, and press < Drying reports > field
- Press field a desired record name, unless it is visible on the top of the list, wind the list forward using navigating keys,
- Report's name consists of date and time of its creation, e.g.
2012.03.12 11:12:15



Caution:

It is possible to use an option for searching a report.

List of parameters in a report from drying process:

1. Start date
2. End date
3. Drying time [average moisture content value obtained in the test time]
4. Status [data on drying process]
5. Start mass [initial mass on drying process start]
6. End mass [mass on completion of drying process]
7. Result [final drying result]
8. Measurements [the following measurements saved during the course of drying process]
9. User [name of a user who carried out drying process]
10. Product [name of a product that was dried]
11. Drying program [name of a drying program used for carrying out the drying process]
12. Drying chart [a chart demonstrating progress of a drying process]

Procedure

- Enter submenu <  Databases >
- Press <  Reports from drying process (Drying reports) > key
- Press field of a desired report record, by pressing name of the report (Report's name consists of date and time of its creation)
- Press option <  Chart >



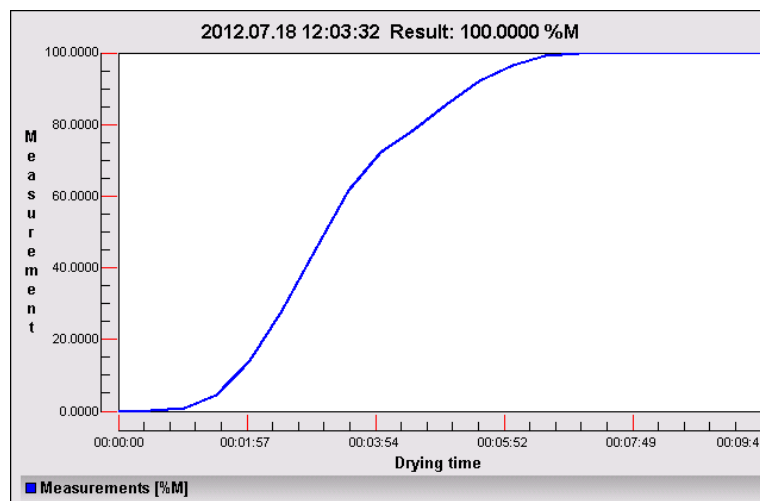

The software automatically generates and opens a chart in the coordinate system of measurement (moisture content unit) / measurement time for completed moisture content analysis.

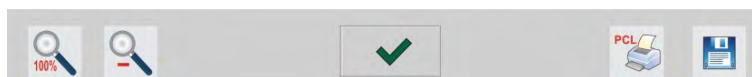
An instance of a chart from completed moisture content analysis for a sample, from a record saved in the database of drying reports.







The bottom bar contains the following soft keys (options):

	Return to displaying the complete chart
	Reducing the screen to the previous view
	Return to displaying the previous window
	Printing the chart on a connected printer PCL type
	Saving the chart as a file in format *.bmp on an external data storage device connected to terminal's USB port.



19.7. Statistics from drying process reports

The menu option enables previewing history of completed drying processes of a specific product. Processes available for each product from the database: previewing reports for each of drying processes, generating charts with obtained humidity content for all tested samples of a product, printing and exporting data on completed drying processes.

Procedure

- Enter submenu < Databases>, and press < Statistics of reports from drying process>
- Select product, for which history of tests should be generated
- Determine searching criteria for displaying data (start date and end date)
- Display list of drying reports complying with accepted searching criteria (product, completion date) <Reports from drying process>
- Generate a chart from the course of selected drying process <Charts from completed drying processes>.

Procedure of generating a chart from completed measurements:

- Enter submenu < Databases> ,
- Press field < Statistics of reports from drying process >
- Select product for which history of completed tests should be generated
- Determine searching criteria for displaying data (start date and end date)
- Press < Charts from completed drying processes > key

The software automatically generates and previews (in the coordinate system of: Result/Measurement no.) a chart containing data on completed drying process.

An instance of a chart is presented below.

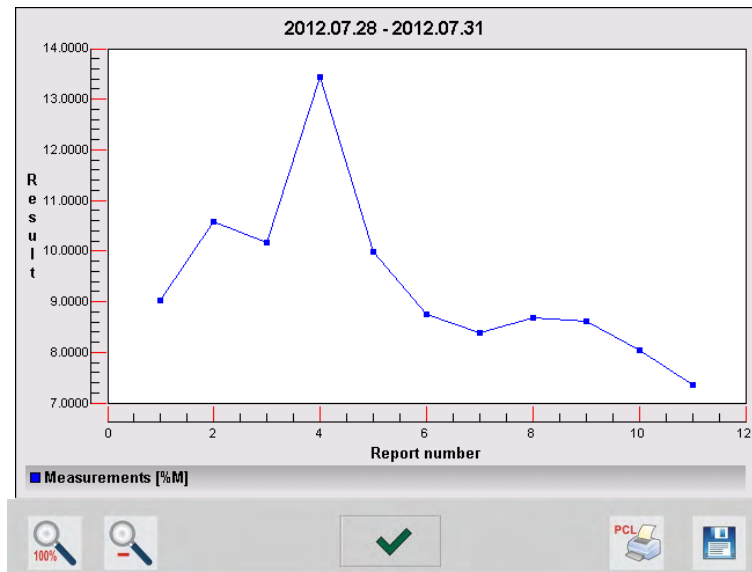

The bottom bar contains the following soft keys (options:

	Return to displaying the complete chart
	Reducing the screen to the previous view
	Return to displaying the previous window
	Printing the chart on a connected printer PCL type
	Saving the chart as a file in format <i>*.bmp</i> on an external data storage device connected to terminal's USB port.



19.8. Minimal sample weight

Minimal sample weight database contains data for declared method and for a given balance minimal sample weights.

Caution:

Only RADWAG employees are authorized either to enter new values of minimal sample weights or to modify the already introduced ones.

Procedure

- Enter < Database> submenu, click < Minimal sample weights> option;
- press < Add> button if a new minimal sample weight is to be included into the database;
- for already included minimal sample weight click its name to enter data that may be edited.

List of data edited for minimal sample weights:

1. Name – the name of a method used for minimal sample weight determination for a given balance.
2. Code – method code.
3. Description – method description.
4. Subsequent control – date of expiry of a minimal sample weight, a pictogram presenting a clock, placed next to the status, informs about the expiry date two weeks in advance. It informs about expiring period of validity. Contact with RADWAG employee is required in order to perform necessary modification of settings.
5. Thresholds – option allowing for entering both, data of mass of minimal sample weight and packaging mass (tare) thresholds for which given value is valid.

Tare – maximal tare value for which minimal sample weigh is valid. Three values may be entered: 0.000g, any mass value out of the balance range and Max sample mass (see examples below).

Minimal mass – minimal mass value determined with application of proper methods for a given balance operating in a specified place.

Example no. 1 for AS 220.3Y with $d=0.0001$ g:

In case of this balance the following values of minimal sample weights have been determined for the corresponding tare values.

No.	Tare value	Minimal sample weight	Description
1	0.0000 g	0.1000 g	Minimal sample weight for all net masses being weighed without packaging (<TARE> button not in use)
2	10.0000 g	1.0000 g	Minimal sample weight for all net masses being weighed in packaging of mass

			ranging from 0.0001 g to 10.0000 g (<TARE> button in use)
3	50.0000 g	2.5000 g	Minimal sample weight for all net masses being weighed in packaging of mass ranging from 10.0001 g to 50.0000 g (<TARE> button in use)
4	200.0000 g	4.0000 g	Minimal sample weight for all net masses being weighed in packaging of mass ranging from 50.0001 g to 200.0000 g (<TARE> button in use)

Example no. 2 for AS 220.3Y:

No.	Tare value	Minimal sample weight	Description
1	220.0000 g	0.5000 g	Minimal sample weight for all net masses being weighed either in packaging of any mass of full permissible range (<TARE> button in use) or without packaging (<TARE> button not in use)

Example no. 3 for AS 220.3Y:



No.	Tare value	Minimal sample weight	Description
1	0.0000 g	0.2500 g	Minimal sample weight for all net masses being weighed without packaging (<TARE> button not in use). Program identifies setting for which minimal sample weight is valid only for weighing samples without packaging. Upon the use of tarring option, the icon informing about minimal sample weight being in use turns off. For weighing with tare no minimal sample weight is defined.

The user can view the entered data but it cannot be edited.

19.9. Ambient conditions

Database of ambient conditions contains parameters related to measurement of ambient conditions at a workstation. Depending on moisture analyzer's configuration, a report may contain data on temperature, humidity and value of atmospheric pressure. In case a THB ambient conditions module is connected to a moisture analyzer, records from the module are also saved.

Procedure

- Enter submenu <  Databases >, and press <  Ambient conditions > field

- Press field of a desired report record, unless it is visible on the top of the list, wind the list forward using navigating keys
- Report's name consists of date and time



Caution:

It is possible to use an option for searching a report

19.10. Packages

Database of packages contains list of packages for which a name, code and mass value are specified. During weighing process, if a name of packaging is selected from the database, the tare value is automatically applied. The display indicates mass value with minus sign.

Procedure

- Enter submenu < Databases>, and press < Packages> field
- Press < Add > key should a new packaging be added
- If a packaging record already exists in the database, press field with its name, and insert data on the packaging.



Caution:

It is possible to use an option for searching a record by name or code.

19.11. Warehouses

Depending on work organizing, the Database of Warehouses contains list of places used for picking up a sample for weighing / drying or list of places to which a sample was delivered. Each Warehouse should have its name, code and description specified. While weighing / drying process, and on selecting name of a Warehouse, it is automatically assigned to the measurement result.

Procedure

- Enter submenu < Databases>, and press < Warehouses> field
- Press < Add > key should a new warehouse be added
- If a warehouse record already exists in the database, press field with its name, and insert identifying data



Caution:

It is possible to use an option for searching a record by name or code.

19.12. Printouts

Database of Printouts contains all saved NON-STANDARD printouts. Each non-standard printout features a name, code and a so called template.

Procedure



- Enter submenu <  Databases >, and press <  Printouts > field
- Press <  Add > key should a new printout be added
- If a non-standard printout template already exists in the database, press field with its name, and insert identifying data.

Caution:

It is possible to use an option for searching a record (printout) by name or code.

Designing new printout template.

Procedure

- Enter submenu <  Databases >, and press <  Printouts > field
- Press <  Add > key to create a new printout or edit an existing template

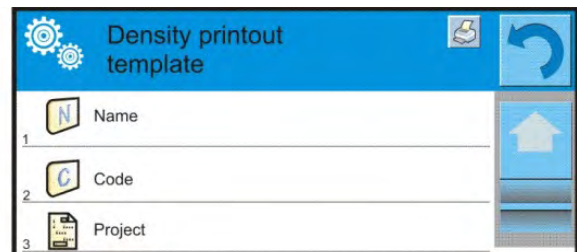
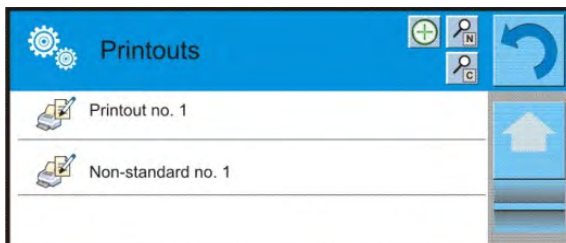

- In the <Record editing> field press <Template> key
- A window is opened for creating an optional printout
- While designing a printout use on-screen keyboard displayed on the touch panel. It features the same options as a regular computer keyboard.

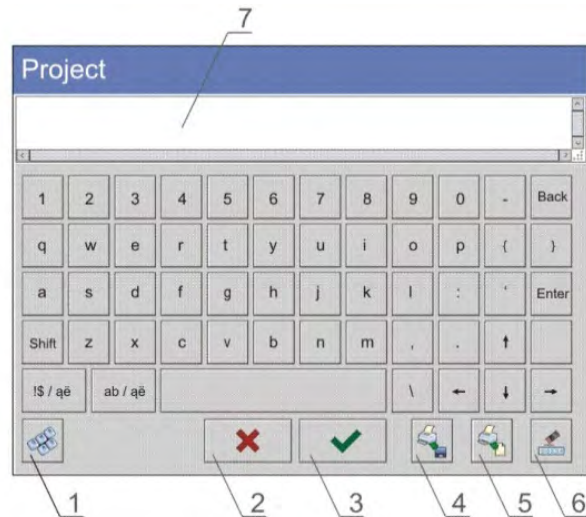

- 1 – enlarging the editing field (7), recommended while using an external computer keyboard connected to balance’s USB port
- 2 – cancelling key
- 3 – accepting key
- 4 – download a printout template from a file
- 5 – list of variables for use while designing a printout
- 6 – delete all printout content
- 7 – printout editing field

- Save designed printout

Caution:

To erase characters in a printout press Back key. To move cursor press navigating arrows.

Example of Printout no. 1 – use of large editing field

<i>Project</i>	<i>Printout template</i>
	<p>Moisture analyzer no. 400015 Parameters: Max = 220 g d= 0.001 g</p> <p>Product name: Date: 2011.10.24 Time: 11:48:06</p> <p>----- Working mode: Weighing -----</p> <p>Net weight: 94.147</p> <p>Carried by: Admin</p>

Example of Printout no. 2 – printout template from a file

A file with printout template has to have an extension: *.txt or *.lb and contain all constant and variable data. After importing, the content of a printout template can be modified.



Procedure:

- Design a *.txt or *.lb file in an optional editor
- Copy the file to a data storage device
- Connect the data storage device to moisture analyzer's USB port
- press [4] <  download a printout template from a file > key
- moisture analyzer's display shows data stored on the data storage device connected to the USB port
- search for a file with printout template and press its name
- the printout template is automatically copied to an editing field

19.13. Universal variables

Universal Variables are a set of alphanumeric data which are combined with printouts, products or other information related to weighing. Each variable should have its name, code and value specified.

Procedure

- Enter submenu <  Databases >, and press <  **Var** Universal variables > field
- Press <  Add > key should a new universal variable be added
- If a universal variable already exists in the database, press field with its name, and insert required modifications to the following fields: code, name, value.

Caution:

It is possible to use an option for searching a record by name or code.

19.14. Database operation

Function allows to operate data stored in a database. There are three possible options: Export weighment database to file, Delete database, Delete weighments and reports.

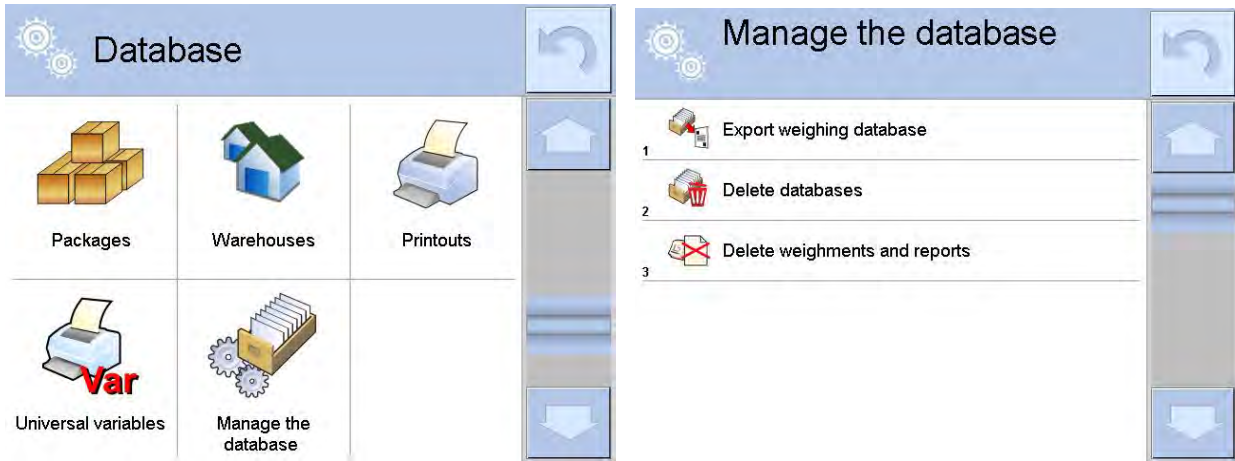

19.14.1. Export database of weighing records to file

All carried out measurements are saved and stored in a database. The moisture analyzer enables exporting such data to a file using a data storage device connected to terminal's USB port.

Procedure:

- Connect a data storage device to moisture analyzer's USB port,
- Press < Export weighing database >, wait to see a window with export options, set demanded parameters.

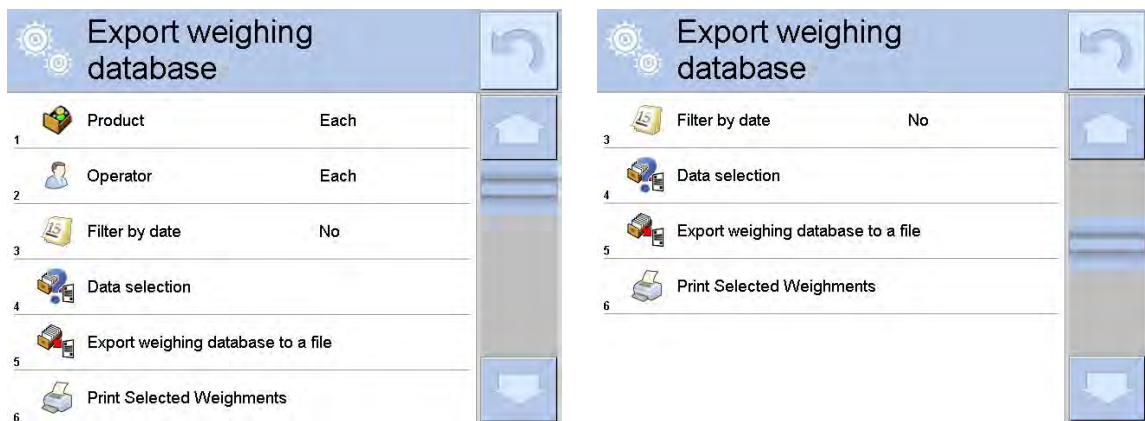

Specify data to be exported, to do it go to <Data selection> option.



- Press < Export weighing database to a file > button, the software automatically starts exporting the database to a file,
- On completing the exporting process, the moisture analyzer displays a message: **“Exporting completed successfully”**, information on number of exported data and a name of file (with extension *.txt), next the program gets back to the previous window.

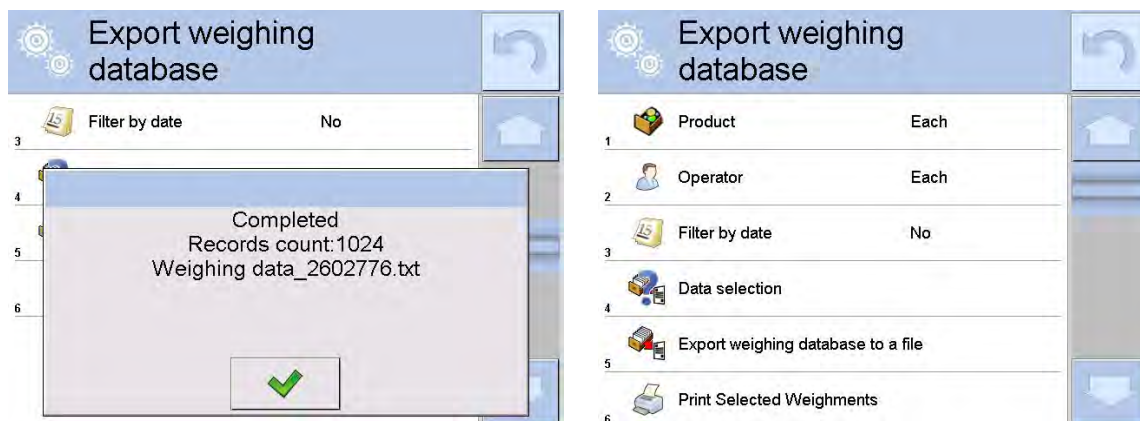

- Go back to weighing or proceed to other settings

Caution:

<Operation error> message is displayed in case a moisture analyzer does not recognize a data storage device that is connected to the USB port; the message appears on entering option <  Export database of weighing records to file >.

- Name of a created file consists of the name of exported database, and serial number of a moisture analyzer, e.g. <Weighing records_239800.txt>.
- Disconnect the data storage device from the USB port of a moisture analyzer.

Format of exported file:

The exported file has a form of a table, where columns are separated by a <Tab> character, which enables direct exporting the file to Excel spreadsheet. The table contains complete data on a carried out measurement, such as: date and time, mass and measuring unit, tare and tare unit, batch number, operator name, client name, packaging name, name of source warehouse, name of destination warehouse, result control.

19.14.2. Delete database

Function allowing for deletion of a chosen database data. Upon its activation a window with databases is displayed. Select a demanded database to delete its data.



Upon confirmation the software deletes data and displays window with number of deleted records:

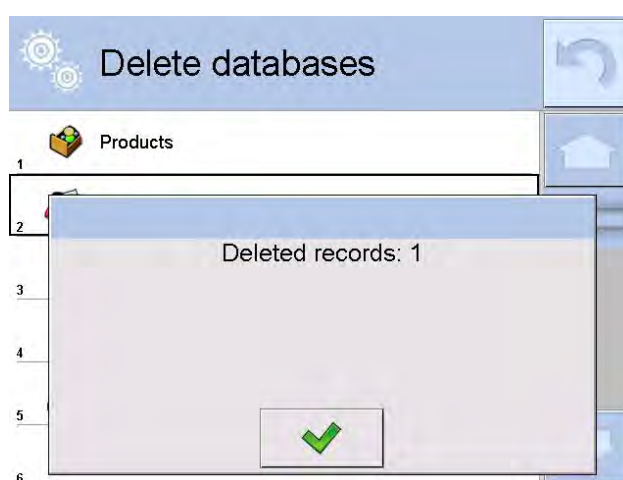

Upon confirmation the software returns to the previous window. The user may either proceed to other operations or get back to weighing.

19.14.3. Delete weighments and reports

Delete weighments and reports option serves to clear database content, it is used for removing weighings and reports. Upon activation of this function the software displays a window with numeric keyboard. Writing deadline date is required. The deadline date determines data to be deleted, namely data older than those specified by the deadline date. Date should be given in the following form: year-month-day.

Date

2000 - 01 - 01

1	2	3	4	5
6	7	8	9	0
Tab	←	→	Back	Del

Manage the database

Export weighing database

Confirm to delete



Upon confirmation of the entered deadline date all weighing and reports dating on a given period of time will be deleted. Number of deleted records will be displayed.

Manage the database





Export weighing database

Deleted records: 30587

20. COMMUNICATION

Menu Communication is located in a menu group Parameters. It is accessed by pressing <  Setup > quick access key and entering submenu <  Communication >.

The moisture analyzer enables communicating with peripheral devices through the following ports:

-  COM 1 (RS232),
-  COM 2 (RS232),
-  Ethernet,
-  Wifi,
-  Tcp.

The ports are configured in group of parameters <  Communication >.

20.1. RS 232 port settings

Procedure:

- Select communication port <  COM1 > or <  COM2 > ,
- Set appropriate values

The RS 232 ports enable the following setting of transmission parameters:

- Baud rate - 4800, 9600, 19200, 38400, 57600, 115200 bit/s
- Data bits - 5, 6, 7, 8
- Stop bits - None, 1, 1.5, 2
- Parity - None, Odd, Even, Marker, Interval

20.2. ETHERNET port settings

Procedure:

- Select communication port <  Ethernet > and set appropriate values:
- DHCP - Yes – No
- IP Address - 192.168.0.2
- Subnet mask - 255.255.255.0
- Default gate - 192.168.0.1

Caution:

Above settings are for information purpose only. Transmission parameters should be selected in accordance with the settings of client's local network.

To carry out changes in the settings, press  key which displays a message:

<to make changes effective, restart the moisture analyzer> ,

Return to weighing mode and restart the device.

20.3. WiFi settings

For balance equipped with WiFi module the top toolbar of the main display has a respective WiFi icon:

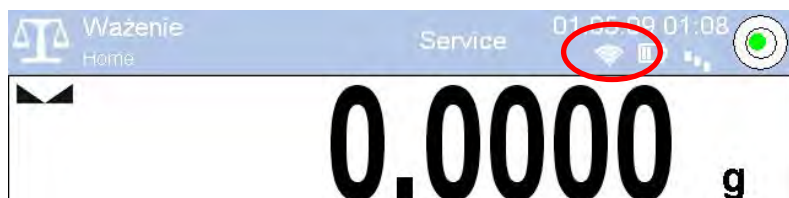

Procedure:

- Select <  Wifi > communication interface, next set the parameters:
 - DHCP - Yes - No
 - IP Adresse - 10.10.9.155
 - Subnet mask - 255.255.255.0
 - Default gateway - 10.10.8.244

Caution:

Above settings serve for informative purposes only. Transmission parameters must be set with respect to local network.

Upon completing modifications, press  key, you will see the following message:

<Restart balance to make it operate with new settings>.

Go to weighing and restart balance.

The user may use <Available networks> option to view the list of networks detected by the balance:



Icon with a padlock, placed by a given network name requires password for the network. Press <Refresh> icon to search for available networks.

To check selected network parameters press <Network status> field, you will see a window with the respective information:

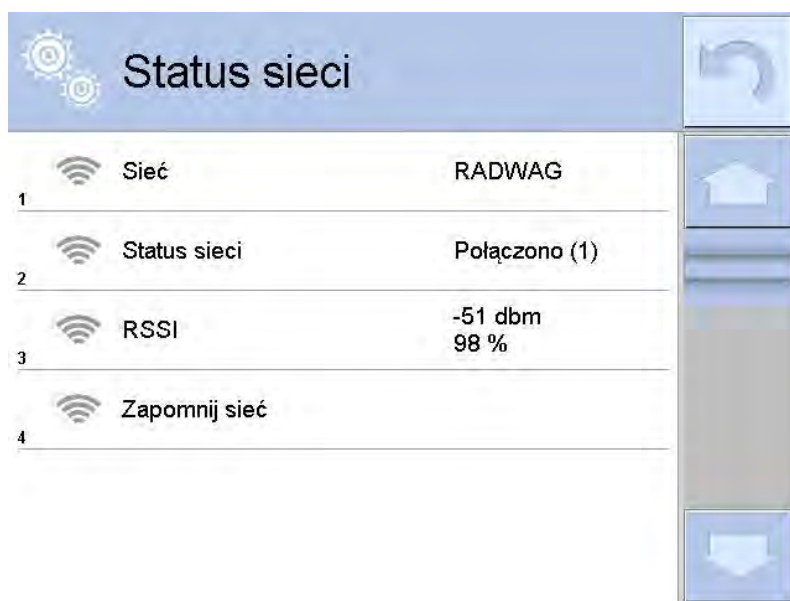





The selected network and parameters for connection are stored in the balance program. The program connects to the network using the stored parameters each time the balance is activated. The user may change this by selecting <Forget network> option. The option disconnects the given network.



20.4. TCP protocol settings

TCP, i.e. Transmission Control Protocol enables communicating two computers. The TCP operates in client-server mode. The server pends for establishing a connection on a specified port, and the client establishes connection with a server.



Procedure of setting a port for "TCP" protocol:

- Enter group of parameters <  Communication > ,
- Select: „ Tcp /  Port“ which opens a window <Port> with on-screen keyboard,
- Insert required port number and accept by pressing  key



21. PERIPHERAL DEVICES

Menu PERIPHERAL DEVICES is located in menu group Parameters. It is accessed by pressing Setup key or  Setup > quick access key and entering submenu <  Peripheral devices>. Inside the menu, there is a list of connectable peripheral devices, which can cooperate with a moisture analyzer.

21.1. Computer

Active connection between a moisture analyzer and a computer is signaled by visible pictogram  displayed in the upper bar of the main window. Submenu <  Computer> enables configuring connection settings.

Procedure:

- press  key and " Peripheral devices /  Computer" key
- set moisture analyzer's parameters related to cooperation with a computer
- computer port
 - o available options: none, COM 1, COM 2, Tcp
- address
 - o give address of a moisture analyzer which is connected to a computer
- continuous transmission
 - o available options: NO, YES (*printout format depends on set printout template in a moisture analyzer – see next parameter*).
- weighing printout template
 - o it is possible to design an individual printout to a computer using a dedicated window with printout template. Principles on creating printouts are described in point 24.11 of this user manual.
- E2R System
 - o E2R System is a modular system performing complex operations of supervision and control over all weighing processes carried out on a balance.

Caution:

Enabling parameter <  **E2R System** > can only be carried out by moisture analyzer's manufacturer or authorized personnel.

If cooperation with E2R is enabled, then all changes on products, clients, users, drying modes, etc. are possible only from the level of E2R computer software.

Access to carrying out changes in this data from moisture analyzer's software level is locked.

21.2. Printer

Moisture analyzer's submenu < Printer > enables:

- Setting communication port with a printer,
- Defining printer's code page, (default 1250)
- Defining controlling codes for PCL printer
- Defining printout standards (templates)

In order to ensure right cooperation of a balance with a printer (correct printout of letters with diacritical signs specified for a given language), suitable speed of transmission must be chosen for the balance, i.e. it must be respective to transmission speed of a printer (see the printer settings). Additionally a given printout code page must be accordant with the printer code page.

Code page accordance may be obtained as follows:

- by setting the right code page in the printer (see the printer manual) – respective to printout code page set in a balance; or
- by sending control code from a balance to the printer, which automatically sets the right code page (respective to code page set in a balance) in advance before execution of the data printout – it is possible only for printers supplied with such option.

Example balance settings for a correct cooperation (Polish diacritical signs printout) with EPSON printer connected to port RS232:

1. **Dot matrix printer EPSON TM-U220B**

Communication parameters of port to which the printer is connected

- *baud rate* – 9600 bit/s
- *data bits* – 8
- *stop bits* – 1
- *parity* – none

Printer's parameters

- *port* – COM1 or COM2 (the one to which the printer is connected)
- *code page* – 852

2. **Thermal printer EPSON TM-T20**

Communication parameters of port to which the printer is connected

- *baud rate* – 38400 bit/s
- *data bits* – 8
- *stop bits* – 1
- *parity* – none

Printer's parameters

- *port* – COM1 or COM2 (the one to which the printer is connected)
- *code page* – 1250
- *control codes* – 1B742D

or

Printer's parameters

- *port* – COM1 or COM2 (the one to which the printer is connected)
- *code page* – 852

- *control codes* – 1B7412

Default values for each of printout standards:

Product printout template	{50} {51}
User printout template	{75} {76}
Client printout template	{85} {86}
Warehouse printout template	{130} {131}
Packaging printout template	{80} {81} {82}

Ambient conditions printout template

```

----- AMBIENT CONDITIONS -----
Date and time      {275}
Temperature of sensor 1: {value} °C
Temperature of sensor 2: {value} °C
Temperature THBS:    {value} °C
Humidity THBS:      {value} %
-----

```

Drying mode printout template	{380} {381}
-------------------------------	----------------

21.3. Barcode scanners

Moisture analyzer MA 3Y series enables cooperating with barcode scanners, which are used to quick searching for:

- Products
- Users
- Customers
- Packagings
- Warehouses
- Universal variables

To configure barcode scanner follow instruction below:



„ /  **Peripheral Devices** /  **Barcode scanner**“.

Caution:

Submenu  **Communication**> requires setting baud rate to compatible with the one used on a barcode scanner (default 9600b/s). Detailed description of communicating the moisture analyzer with a barcode scanner is provided in **APPENDIX E** of this user manual.

21.3.1. Barcode Scanner's Port

Procedure:

1. Open  Peripherals> group of parameters.
2. Press  **Barcode scanner**>.
3. Select suitable option of those presented below.

Ports:

- RS 232 (COM1),
- RS 232 (COM2),
- USB





21.3.2. Prefix/Suffix

You can edit  **Prefix**> and  **Suffix**> to synchronize balance's program with barcode scanner.

Caution

In RADWAG balances prefix contains character (byte) presented as 01 hexadecimal, whereas suffix contains character (byte) 0D hexadecimal. For detailed description of communicating the balance with a barcode scanner go to APPENDIX E of this user manual.



Procedure:

1. Open  **Barcode scanner**> submenu.
2. Select  **Prefix**> parameter and enter hexadecimal value using on-screen keyboard.
3. Press  to confirm changes.
4. Select  **Suffix**> parameter and enter hexadecimal value using on-screen keyboard.
5. Press  to confirm changes.

21.3.2. Field Selection

You can customize field selection in databases after which searching is carried out.

Procedure:









1. Open  Peripherals> group of parameters.
2. Select  **Barcode scanner**/  **Fields selection**>.
3. The following list is displayed:









Product



Universal variable 1

	User		Universal variable 2
	Customer		Universal variable 3
	Packaging		Universal variable 4
	Warehouse		Universal variable 5

4. Select one item from the list. The following parameters may be edited:

	Filtering	Selecting object for which the searching is carried out (see table below)
	Offset	Setting first significant barcode sign from which the searching is carried out. All preceding signs are omitted.
	Code length	Setting number of barcode signs used for searching.
	Start marker	Selecting starting point of scanned code used for searching.
	End marker	Selecting ending point of scanned code used for searching.
	Ignore marker	Selecting using or ignoring start and end markers when comparing scanned code with code saved to the balance.



List of Filtering items:

Field selection	Filtering
Product	None, Name, Code, EAN code
User	None, Name, Code,
Customer	None, Name, Code,
Packaging	None, Name, Code,
Warehouse	None, Name, Code,
Formulation	None, Name, Code,
Pipette	None, Name, Code,
Series	None, Name, Code,
Universal variables	None, Active

21.3.3 Test

< **Test**> function enables correct operation of barcode scanner connected to balance.

Procedure:

5. Open < **Barcode scanner**> submenu.
6. Press < **Test**> parameter; <**Test**> window opens with ASCII and HEX fields in it.
7. Scanned barcode is entered into ASCII or HEX field; result of test is displayed in the bottom part of the window.

When:

- <**Prefix**> and <**Suffix**> are identical for both – balance settings and scanned barcode – the test is <**Positive**>.
- <**Prefix**> and <**Suffix**> differ for both – balance settings and scanned barcode – the test is <**Negative**>.

21.4. Transponder card scanner

Selecting (logging) a user on each switching on the moisture analyzer can be carried out by means of:

- Inserting user's password using on-screen keyboard,
- With a transponder card scanner, by approximating a registered card to the scanner.

Caution:

*For correct moisture analyzer's cooperation with a transponder card scanner set appropriate baud rate value in submenu < **Communication**> (default 9600b/s).*

Transponder card scanner port.

The moisture analyzer enables communicating with a transponder card scanner using the following ports:



- RS 232 (COM1),
- RS 232 (COM2).

Assigning number of a card to a user:

In order to log in an operator using a transponder card scanner, first assign a number of an already registered card to a selected user in the database of operators.

Procedure:

- Connect a transponder card scanner to a moisture analyzer's port (RS 232 COM1 or RS 232 COM2), select communication port in moisture analyzer settings for the transponder card scanner
- In submenu < **Communication**> set baud rate for compatible with the one of the transponder card scanner (default 9600b/s).

- Enter the database of operators and edit desired operator's record, go to < Card number> option,
- On entering editing mode in < Card number> option, an editing window <Card number> is opened with an on-screen keyboard,
- Approximate the card to the transponder card scanner. The moisture analyzer automatically displays number of detected card in the <Card number> field,
- Accept recognized number by pressing  key and returning to the main window of weighing mode.





21.5. Additional display

The moisture analyzer enables communicating with an additional display using the following ports:

- RS 232 (COM1),
- RS 232 (COM2),
- Tcp.

Type of data displayed on an additional display is declared in variable <Project (template)>.

Procedure – designing a variable

- Enter group of parameters < Peripheral devices>
- Press " Additional display /  Project" field, which opens an editing window <Project> with an on-screen keyboard,
- Use the on-screen keyboard to insert desired value of a standard, or
- Select desired value of a standard using a list displayed on pressing < > key
- Accept by pressing  key.

Caution:

Default setting of parameter < Standard>: a variable with value {140}.

22. INPUTS / OUTPUTS

Application of inputs:

The set of inputs is used to control moisture analyzer's operation. Each of 4 inputs is connectable to the following functions or keys:





- Checkweighing thresholds
- Target value
- Profile
- Adjustment/Calibration
- Zero
- Tare
- Set tare
- Disable tare
- Restore tare
- Packaging
- Print
- Header printout
- Footer printout
- Universal variable 1 ÷ 5
- Accept
- Abort
- User
- Left door
- Right door
- Parameters
- Statistics
- Add to statistics
- Product
- Warehouse
- Client
- Parts counting: give part mass
- Parts counting: set mass of a single part
- Percent setup: give reference mass
- Percent setup: set 100%
- Density of solid
- Density of liquid
- Air density
- Control mass comparator's robot
- Task
- Reference standard

On changing the logic status of the input system, e.g. from [0] to [1] a function that is assigned to the system is carried out.

For instance:

- Displaying the value of set checkweighing thresholds: Min, Max, or
- Restoring tare value to weigh net mass of measured load .

Procedure

- Press  key and press: "Inputs / Outputs" key.
- Enter submenu  Inputs / Outputs>, select and press  Inputs> key
- Enter editing mode of a selected input, which opens list of available functions,
- Select a function from displayed list and return to weighing.





Application of outputs:

The set of outputs is used to SIGNAL the status of measurement result. Change of logic status of the output system, e.g. from [0] to [1] takes place on meeting a requirement assigned to the output.

Each of 4 outputs is connectable to the following data:

Available options	Moisture analyzer status, which switches the logic of output
None	-----
Stable	Each stable measurement switches the logic of the system
MIN stable	Stable measurement below [MIN] threshold switches the logic of the system,
MIN unstable	Unstable measurement below [MIN] threshold switches the logic of the system,
OK stable	Stable measurement within [MIN] [MAX] thresholds switches the logic of the system,
OK unstable	Unstable measurement within [MIN] [MAX] thresholds switches the logic of the system,
MAX stable	Stable measurement below [MAX] threshold switches the logic of the system,
MAX unstable	Unstable measurement below [MAX] threshold switches the logic of the system
Confirmation of cycle completion	End of procedure

Procedure

- Press  key and press: "Inputs / Outputs" key.
- Enter submenu  Inputs / Outputs>, select and press  Outputs> key
- Enter editing mode of a selected output, which opens list of available functions,
- Select a function from displayed list and return to weighing with saving carried out changes.



23. OTHER PARAMETERS

This menu contains global parameters on moisture analyzer operation, such as: language, date-time, beep sound, display calibration, level control.

Enter submenu <Others>, by pressing  key and  Other> key.

23.1. Interface language

Procedure



Enter submenu  Others>, press  Language> option and select language version of moisture analyzer's communication interface.

Available language version:

- Polish,
- English,
- German,
- French,
- Spanish,
- Korean
- Turkish
- Chinese
- Italian
- Czech
- Romanian
- Hungarian
- Russian

23.2. Data and time setting

Moisture analyzer user can set date and time, which are located in the upper bar of the display. Entering editing mode of date and time settings is carried out in two ways:

- By pressing "date and time" field located in the upper bar of moisture analyzer's display (in main menu mode),
- By pressing  key, and selecting menu:  Other /  Date and Time".

Entering date and time setting mode opens an on-screen keyboard. Set date and time in the following sequence: year, month, day, hour, minute and accept set values by pressing  key.

Caution:

Access to  Date and Time> option in moisture analyzer's menu is conditioned by setting of access level for this parameter.

23.3. "Beep" sound

Procedure:



Enter submenu < Others>, press < Beep> and set one of available options.

- | | |
|---------|---|
| No | - Beep sound switched off (disabled) for keys and proximity sensors |
| Keys | - Beep sound active as reaction to pressing keys |
| Sensors | - Beep sound active as reaction to operation of proximity sensors |
| All | - Beep sound reacting to both keys and proximity sensors |

23.4. Volume



The user may adjust power of the loudspeaker which is mounted in a read head:

To adjust the volume:

Press  key, next select „ Other / Volume” option. Using on-screen keyboard enter percent value of the volume. 100% is the highest volume, 0% the lowest (loudspeaker off).

23.5. Sleep mode

The user has the sleep mode at his disposal, thus he can turn off the display. In order to enter the sleep mode:

- press  key, next press: „ Others / Sleep mode”.

On entering the option one of the following settings must be selected: [None; 1; 2; 3; 5; 10; 15]. Digit values stand for a number of minutes. Upon selection of a desired value the program returns to the previous menu level.

Caution:

The screen turns to sleep mode only when the balance is not operated (the indication on the screen remains the same). Upon turning to the sleep mode the balance returns to weighing mode automatically if only any weight modification is detected or screen touch or key on an overlay pressed.

23.6. Display brightness

Display brightness influences balance operation time, when the balance is powered by means of a battery. If the user wants to lengthen the operation cycles as much as possible he should reduce the brightness of the display.

In order to enter the display brightness option:



- press  key, next press: „ Others / Display brightness”.

On entering the option enter a desired value [0% - 100%]. Upon entering a particular value the brightness changes respectively and the program returns to the previous menu level.

23.7. Touch screen display calibration

Touch screen display calibration is required if during operation a user spots incorrect reaction of the touch panel.

Procedure:

- Enter submenu < Others>
- Select parameter < Touch screen display calibration> which opens an editing window,
- Use finger or a thin (but not sharp edged) and soft stylus to press and hold a display area occupied by a cross. After pressing the fifth cross in sequence, accept the changes by pressing  key.



Caution:

The process can be aborted by pressing Esc key on an external keyboard connected to the moisture analyzer's terminal. Other means of aborting calibration process are not available, and if initiated, calibration has to be completed.

23.8. Level control

Moisture analyzer MA 3Y series may feature an Automatic Level Control system or an external level indicator.

Leveling procedure with use of the Automatic Level Control system:

- Enter submenu < Others >
- Select parameter < Level control> which opens an editing window,
- Select one of available options:
 - None – level indicator is not displayed, the moisture analyzer does not control level status,
 - Active – level indicator is displayed, the moisture analyzer alerts on level change by changing colour of level indicator (green → level status OK., red → level status lost)
 - Active with lock – level indicator is displayed , the moisture analyzer alerts on level change by changing colour of level indicator (green → level status OK., red → level status lost). If level indicator is red, the display also shows an alert – no Level - , and blocks weighing function until level status is restored.

Caution:

Means of leveling the moisture analyzer is described in point 11.3 of this user manual.

23.9. Drying temperature reducing

This parameter automatically determines reducing the drying temperature after a time interval specified for a moisture analyzer with Max drying temperature of 250 °C.

Means of operation:

While drying temperature holds within a limit between 161 °C and 250 °C then the drying temperature can be maintained proportionally to set temperature value, i.e. about 15 hours for the temperature 161 °C and about 10 minutes for the temperature 250 °C.

While drying a sample in a temperature set to 250 °C, this temperature can be maintained for the time of 10 minutes, and afterwards the software automatically reduces the temperature to 160 °C (drying process is continued without break).

The time of reducing the temperature from 250 °C to 160 °C is about 10 minutes.

For the QUICK MODE the initial exceeding of the Max drying temperature is 30 %, but not higher than the maximum drying temperature of a moisture analyzer.

Procedure:

- Enter submenu < Others>
- Select parameter <Reduction of drying temperature> which opens a new window with selectable values
- Select one of the available options:
 - YES – temperature reduction mode enabled
 - NO – temperature reduction mode disabledSelecting a value causes returning to the menu window.

Caution:

Remember that prolonged drying a sample is temperature above 160 °C may cause damaging the components of the moisture analyzer.

23.10. Compatibility with MAC/MAX series

This parameter enables reflecting operation of moisture analyzers MAC and MAX series. By enabling the parameter (i.e. settings its value to ,YES>), the moisture analyzer MA 3Y series starts functioning (in the field of drying temperatures and control of the drying process) as the moisture analyzers MAC and MAX series (in comparable temperature conditions).

The parameter enables a user to use the drying mode settings as in case of the moisture analyzers MAC and MAX series. Thus, on purchasing a moisture analyzer MA 3Y series it is not necessary to determine the drying parameters for the products to be dried, but simply use the selected and proved drying modes.

Procedure:

- Enter submenu < Others>
- Select parameter <Compatibility with MAC/MAX> which opens a window with drop down menu,
- Select one of available options:
 - YES – parameter enabled
 - NO – parameter disabled

Selecting the parameter value causes immediate returning to the menu window.

23.11. Sensors sensitivity

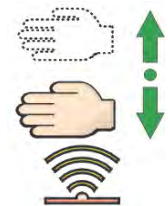

The parameter is adjustable between 0 – 9, and it determines the distance from which the IR proximity sensors should react. As standard, the sensitivity is set within the range of 5 to 7.

Procedure:

- Enter submenu < Others>
- Select parameter <Sensor sensitivity> which opens an editing window,
- Select one of available options. The selection causes immediate returning to the menu window.

23.12. Proximity sensors delay

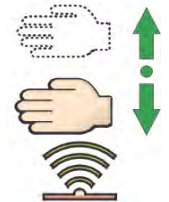

Parameter for setting delay of proximity sensors, it is expressed in [ms]. By default the value is set to <0>.

When using option of motion recognition the user must remember about setting <proximity sensors delay> parameter to value <**500ms**>

Procedure:

- a) Go to < Other> submenu.
- b) Select <Proximity sensors delay> parameter and wait for a dialog window with an on-screen keyboard to open.
- c) Enter value <500>.
- d) Confirm. The program returns to menu window.

23.13. Autotest

Option permanently disabled in the moisture analyzer MA 3Y series.

23.14. Start logo

Caution:

This parameter is available only for authorized operator of a moisture analyzer.

The parameter enables changing the image displayed on the terminal on moisture analyzer start up.

23.15. Export system events

Caution:

This parameter is available only for authorized operator of a moisture analyzer.

The parameter is used to generating a special type of a file that is saved automatically on parameter enabling on an external data storage device plugged to moisture analyzer's USB port.

The file is used by RADWAG service personnel to diagnose potential problems in moisture analyzer operation.

Procedure:

- Plug an external data storage device to the USB port
- Enter submenu <👉📁 Others>
- Select parameter <Export system events> ,
- The software automatically generates a file and saves it on the external data storage device.
- Send the generated file to the RADWAG company.

24. UPDATE

The function contains modules which enable updating:

- Help files available from the user level
- Area of a user: SOFTWARE
- Metrological parameters: main board (only administrator).

Updating process takes place automatically by uploading data from a data storage device connected to moisture analyzer's USB port.

Software updating procedure:

- Prepare a data storage device with update file. Required file extension: **.lab2*
- Connect the data storage device to moisture analyzer's USB port
- Select menu <Software>
- The display previews content saved on the data storage device, search for the update file and press its name.
- Updating process takes place automatically

The process of updating help files and the main board file takes places analogously to the above described procedure, but the required extension of the update file is: *.hlp - help, *.mbu – main board.

Caution:

Weighing module updating procedure is accessible to authorized service points only. If the update file is incorrect, the moisture analyzer displays a message on process error – moisture analyzer parameters remain unchanged.

25. SYSTEM INFORMATION

This menu contains data on moisture analyzer’s specification and installed applications. Most of parameters in this menu are for the information purpose only.

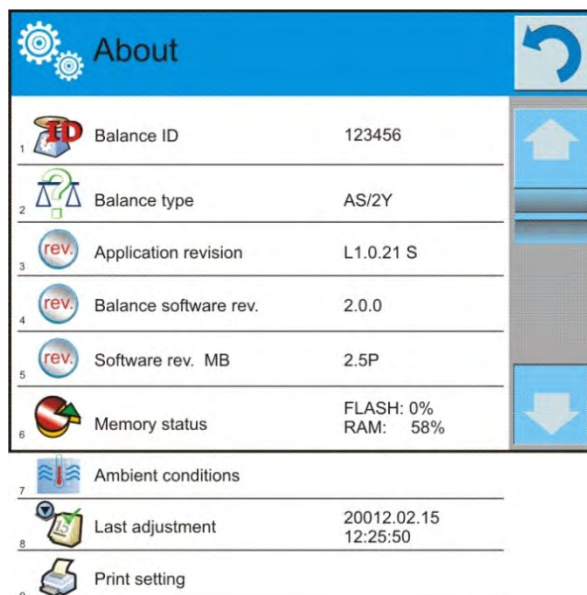

About	
1	Balance ID 123456
2	Balance type AS/2Y
3	Application revision L1.0.21 S
4	Balance software rev. 2.0.0
5	Software rev. MB 2.5P
6	Memory status FLASH: 0% RAM: 58%
7	Ambient conditions
8	Last adjustment 20012.02.15 12:25:50
9	Print setting

Parameter <Ambient conditions>, enables previewing present ambient conditions in a moisture analyzer: temperature, humidity, pressure (if a moisture analyzer features corresponding ambient conditions sensors or has a THB ambient conditions module connected).

On selecting parameter <Print settings> the moisture analyzer sends all settings to a printer connected to device’s communication port.

26. MOVIES

Option activating instructional movie explaining how to operate balance functions.

To view the movie go to <Movies> parameter group, select the demanded file and press to watch the movie stored in the balance memory.

The program plays *.wmv files.

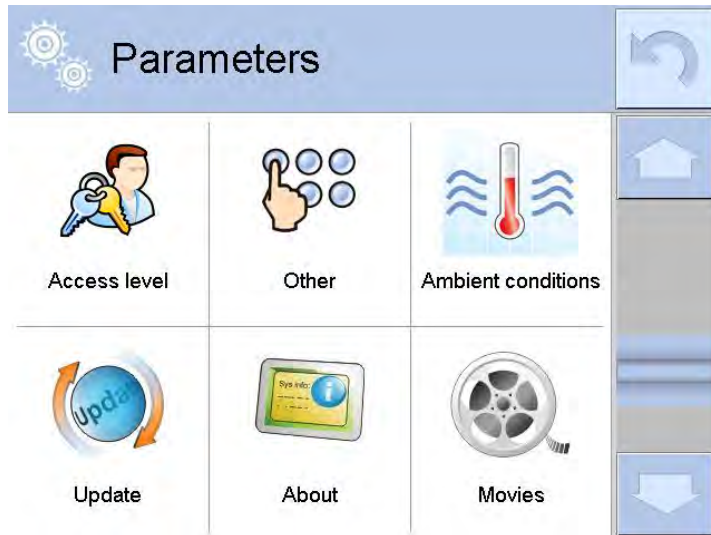

<Movies> parameter group allows the user to add/delete movies from the balance memory.

To add a movie the user has to:

1. Save the movie on a memory stick,
2. Plug the memory stick to USB port of balance head,
3. Enter <Movies> parameter group,
4. Press <  > icon located in a top toolbar,
5. Select demanded file,
6. The movie is stored to the balance memory.

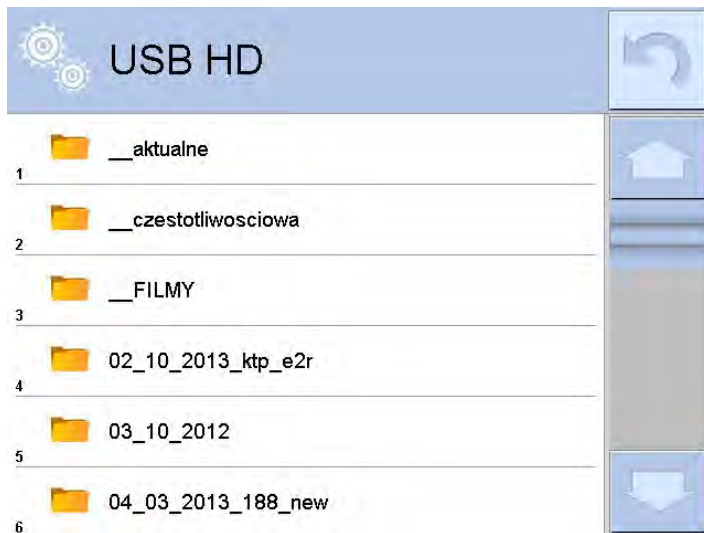

To play the movie the user has to:

1. Save the movie to the balance memory (see instruction above)
2. Enter <Movies> parameter group
3. Press the name of a movie to be watched



The movie starts automatically. Functions available for playback are as follows:

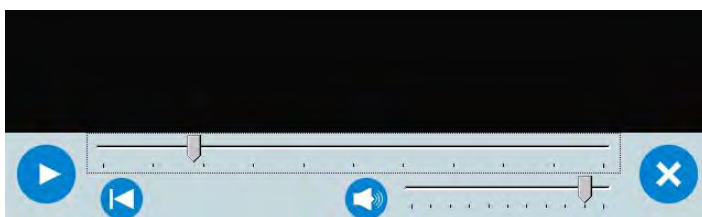

	Play/ Pause playing
	Stop playing
	Increase/decrease the volume (volum power adjusted, for settings go to OTHER parameters group).
	Włączenie/ wyłączenie głosu
	Restart video

27. COMMUNICATION PROTOCOL

General information

- A. A character based communication protocol moisture analyzer-terminal is designed for establishing communication between a RADWAG instruments and a peripheral devices via RS 232 interface.
- B. It consists of commands sent from a peripheral device to a moisture analyzer and responses from the moisture analyzer.
- C. Responses are sent from the moisture analyzer on each receipt of a command as a reaction for a specific command.
- D. Commands forming the communication protocol enable obtaining data on moisture analyzer's status and influencing its operation, e.g.: request measurement results from a moisture analyzer, zero indication, etc.

27.1. A set of commands

Command	Command description
Z	Zero moisture analyzer
T	Tare moisture analyzer
OT	Give tare value
UT	Set tare
S	Send stable measurement result in basic measuring unit
SI	Immediately send measurement result in basic measuring unit
SU	Send stable measurement result in current measuring unit
SUI	Immediately send measurement result in current measuring unit
C1	Switch on continuous transmission in basic measuring unit
CO	Switch off continuous transmission in basic measuring unit
CU1	Switch on continuous transmission in current measuring unit
CU0	Switch off continuous transmission in current measuring unit
DH	Set low checkweighing threshold LO
UH	Set high checkweighing threshold HI
ODH	Give value of low checkweighing threshold LO
OUH	Give value of high checkweighing threshold HI
PC	Send all implemented commands
LOGIN	User log in
LOGOUT	User log out
SS	Result release
IC	Internal calibration

K1	Lock balance keyboard
K0	Unlock balance keyboard
BP	Start BEEP signal
OMI	List available working modes
OMS	Set working mode
OMG	Give current working mode
PC	Send all implemented commands
BN	Give balance type
FS	Give Max capacity
RV	Give program version
A	Set autozero function
EV	Set ambient conditions state
FIS	Set filter
ARS	Set value release
LDS	Set last digit

Caution:

Each command must end with CR LF characters;

27.2. Responses format for commands sent from computer level

On receipt of a command, the terminal sends a response in one of the following formats:

XX_A CR LF	command understood and in progress
XX_D CR LF	command carried out (appears only after the command XX_A)
XX_I CR LF	command understood but not accessible at this moment
XX _ ^ CR LF	command understood but max range is exceeded
XX _ v CR LF	command understood but min range is exceeded
XX _ OK CR LF	Command carried out (completed)
ES_CR LF	Command not recognized
XX _ E CR LF	an error occurred on command carrying out (time limit exceeded while waiting for stable measurement result (time limit is moisture analyzer's characteristic parameter))

XX - stands for a name of sent command
 _ - substitutes spaces

COMMANDS DESCRIPTION



CAUTION

Spaces provided in commands format have to be skipped, they are provided for improving text readability only.

Zero the moisture analyzer

Format: **Z CR LF**

Accessible responses:

- Z_A CR LF - command understood and in progress
- Z_D CR LF - command carried out
- Z_A CR LF - command understood and in progress
- Z_^ CR LF - command understood but zeroing range exceeded

- Z_A CR LF - command understood and in progress
- Z_E CR LF - time limit exceeded while waiting for stable measurement result
- Z_I CR LF - command understood but not accessible at this moment

Tare the moisture analyzer

Format: **T CR LF**

Accessible responses:

- T_A CR LF - command understood and in progress
- T_D CR LF - command carried out
- T_A CR LF - command understood and in progress
- T_v CR LF - command understood but tarring range exceeded

- T_A CR LF - command understood and in progress
- T_E CR LF - time limit exceeded while waiting for stable measurement result
- T_I CR LF - command understood but not accessible at this moment

Give tare value

Format: **OT CR LF**

Accessible responses: **OT_TARE CR LF** – command carried out

Response format:

1	2	3	4-12	13	14	15	16	17	18	19
O	T	space	tare	space	unit			space	CR	LF

- Tare** - 9 characters with right justification
- Unit** - 3 characters with left justification

Caution:

Tare value is always given in adjustment unit.

Set tare

Format: **UT_TARE CR LF**, where **TARE** – tare value

Accessible responses:

- UT_OK CR LF - command carried out
- UT_I CR LF - command understood but not accessible at this moment
- ES CR LF - command not recognized (tare format incorrect)

Caution:

Use dot in tare format as decimal point.

Send stable measurement result in basic measuring unit

Format: **S CR LF**

Accessible responses:

- S_A CR LF - command understood and in progress
- S_E CR LF - time limit exceeded while waiting for stable measurement result
- S_I CR LF - command understood but not accessible at this moment
- S_A CR LF - command understood and in progress
- MASS FRAME - response is mass value in basic measuring unit

Mass frame format which is moisture analyzer's response:

1	2-3	4	5	6	7-15	16	17	18	19	20	21
S	space	stability marker	space	character	mass	space	unit			CR	LF

Example:

S CR LF - command sent from a computer

S _ A CR LF - command understood and in progress

S _ _ _ _ _ _ _ 8 . 5 _ g _ _ CR LF - command carried out, response is mass value in basic measuring unit.

Immediately send measurement result in basic measuring unit

Format: **SI CR LF**

Accessible responses:

- SI_I CR LF - command understood but not accessible at this moment
- MASS FRAME - response is immediate with mass value in basic weighing unit

Mass frame format which is moisture analyzer's response:

1	2	3	4	5	6	7-15	16	17	18	19	20	21
S	I	space	stability marker	space	character	mass	space	unit			CR	LF

Example:

S I CR LF - command sent from a computer

S I _ ? _ _ _ _ _ _ 1 8 . 5 _ g _ CR LF - command carried out, immediate response of mass value in basic weighing unit

Send stable measurement result in current weighing unit

Format: **SU CR LF**

Accessible responses:

- SU_A CR LF - command understood and in progress
- SU_E CR LF - time limit exceeded while waiting for stable measurement result
- SU_I CR LF - command understood but not accessible at this moment
- SU_A CR LF - command understood and in progress
- MASS FRAME - response is mass value in current measuring unit

Mass frame format which is moisture analyzer's response:

1	2	3	4	5	6	7-15	16	17	18	19	20	21
S	U	space	stability marker	space	character	mass	space	unit		CR	LF	

Example:

S U CR LF - command from a computer

S U _ A CR LF - command understood and in progress

S U _ _ _ - _ _ 1 7 2 . 1 3 5 _ N _ _ CR LF - command carried out, response is mass value in current measuring unit.

Immediately send measurement result in current measuring unit

Format: **SUI CR LF**

Accessible responses:

- SUI_I CR LF - command understood but not accessible at this moment
- MASS FORMAT - mass value in current measuring unit is returned immediately

Mass frame format which is moisture analyzer's response:

1	2	3	4	5	6	7-15	16	17	18	19	20	21
S	U	I	Stability marker	space	sign	mass	space	unit		CR	LF	

Example:

S U I CR LF - command from a computer

S U I ? _ - _ _ _ 5 8 . 2 3 7 _ g _ CR LF - command carried out, immediate response of mass value in current measuring unit

Where: _ - space

Switch on continuous transmission in basic measuring unit

Format: **C1 CR LF**

Accessible responses:

- C1_I CR LF - command understood but not accessible at this moment
- C1_A CR LF - command understood and in progress
- MASS FRAME - response is mass value in basic measuring unit

Mass frame format which is moisture analyzer's response:

1	2	3	4	5	6	7-15	16	17	18	19	20	21
S	I	space	stability marker	space	character	mass	space	unit			CR	LF

Switch off continuous transmission in basic measuring unit

Format: **C0 CR LF**

Accessible responses:

- C0_I CR LF - command understood but not accessible at this moment
- C0_A CR LF - command understood and in progress

Switch on continuous transmission in current measuring unit

Format: **CU1 CR LF**

Accessible responses:

- CU1_I CR LF - command understood but not accessible at this moment
- CU1_A CR LF - command understood and in progress
- MASS FRAME - response is mass value in current measuring unit

Mass frame format which is moisture analyzer's response:

1	2	3	4	5	6	7-15	16	17	18	19	20	21
S	U	I	stability marker	space	character	mass	space	unit			CR	LF

Switch off continuous transmission in current weighing unit

Format: **CU0 CR LF**

Accessible responses:

- CU0_I CR LF - command understood but not accessible at this moment
- CU0_A CR LF - command understood and in progress

Set low checkweighing threshold LO

Format: **DH_XXXXX CR LF**, where: **_** - space, **XXXXX** – mass format

Accessible responses:

- DH_OK CR LF - command carried out

ES CR LF - command not recognized (incorrect mass format)

Set high checkweighing threshold HI

Format: **UH_XXXXX CR LF**, where: **_** - space, **XXXXX** – mass format

Accessible responses:

UH_OK CR LF - command carried out

ES CR LF - command not recognized (incorrect mass format)

Give value of low checkweighing threshold HI

Format: **ODH CR LF**

Accessible response: **DH_MASS CR LF** – command carried out

Response format:

1	2	3	4-12	13	14	15	16	17	18	19
D	H	space	mass	space	unit			space	CR	LF

Mass - 9 characters with right justification

Unit - 3 characters with right justification

Give value of high checkweighing threshold LO

Format: **OUH CR LF**

Accessible response: **UH_MASS CR LF** - command carried out

Response format:

1	2	3	4-12	13	14	15	16	17	18	19
U	H	space	mass	space	unit			space	CR	LF

Mass - 9 characters with right justification

Unit - 3 characters with left justification

User log in

Format: **LOGIN Name, Password CR LF** (Name and password have to be inserted as they are set in the moisture analyzer – small and capital letters)

Accessible responses:

LOGIN OK CR LF - command understood, new user is logged in

LOGIN ERROR CR LF - command understood, an error in name or password occurred, log in failed

ES CR LF - command not recognized (error in format)

User log out

Format: **LOGOUT CR LF**

Accessible responses:

- LOGOUT OK CR LF - command understood, user is logged out
- ES CR LF - command not recognized (error in format)

The result release

Format: **SS CR LF**

Accessible responses:

- SS_OK CR LF - command understood, realization in progress
- The command simulates pressing PRINT button on an overlay, according to settings selected for result release.

Internal adjustment/calibration

Format: **IC CR LF**

Accessible responses:

- IC_A CR LF - command understood, realization in progress
- IC_D CR LF - calibration completed
- IC_A CR LF - command understood, realization in progress
- IC_E CR LF - time limit of result stabilization exceeded
- IC_I CR LF - command understood but not accessible at this moment

Lock balance keyboard

Format: **K1 CR LF**

Accessible responses:

- K1_I CR LF** - command understood but not accessible at this moment
- K1_OK CR LF** - command completed

Command locks balance keyboard (motion sensors, touch panel) until it gets unlocked either by K0 command or by switching the balance off.

Unlock balance keyboard

Format: **K0 CR LF**

Accessible responses:

- KO_I CR LF** - command understood but not accessible at this moment
- KO_OK CR LF** - command completed

Start BEEP signal

The command activates BEEP signal for a specified time limit.

Format: **BP_TIME** <CR><LF>

Accessible responses:

- BP_OK** <CR><LF> – command completed, BEEP signal activated
- BP_E"** <CR><LF> – incorrect format or lack of the parameter
- BP_I** <CR><LF> – command understood but not accessible at this moment

TIME – parameter, decimal value, determined time limit for the signal, given in [ms]. Recommended range <50 ÷ 5000>.

If value greater than the valid one is given, the BEEP sound is activated for the maximal available time limit.

Example

Command:

BP_350<CR><LF> – turn BEEP signal for 350 ms

Response:

BP_OK<CR><LF> – BEEP on

Caution! – BEEP signal activated by BP command gets aborted if it is activated by means of other devices: keyboard, touch panel, proximity sensors.

OMI - list available working modes

The command lists available working modes for a given device

Format: **OMI** <CR><LF>

Accessible responses:

- OMI** <CR><LF> – command completed, available working modes are given
- n_**"Mode name"
<CR><LF>
:
- n_**"Mode name"
<CR><LF>
- OK** <CR><LF>
- OMI_I** <CR><LF> – command understood but not accessible at this moment

Mode name – parameter, working mode name, given in between inverted commas. Form of the name is the same like on the balance display, it is given in a currently operating language.

n – parameter, decimal value specifying working mode number.

n → 1 – Weighing

17 – Pippette calibration

Caution: working modes numbering is assigned to working modes names and it is the same for each balance types.

Some balances in response to **OMI** may give working modes numbers without names.

Example1

Command:

OMI <CR><LF> – give available working modes

Response:

OMI <CR><LF> – available working modes are given
2_ "Parts counting" <CR><LF> number + name
4_ "Dosing" <CR><LF>
12_ "Checkweighing" <CR><LF>
OK <CR><LF> – command completed

Example2

Command:

OMI <CR><LF> – give available working modes

Response:

OMI <CR><LF> – available working modes are given
2 <CR><LF> (mode number)
4 <CR><LF>
12 <CR><LF>
OK <CR><LF> – command completed

OMS - Set working mode

Command sets current working mode of a balance.

Format: **OMS_n** <CR><LF>

Accessible responses:

OMS_OK <CR><LF> – command completed

OMS_E <CR><LF> – error occurrence in course of command performance, incorrect format or lack of the parameter

OMS_I <CR><LF> – command understood but not accessible at this moment

n – parameter, decimal value specifying working mode number. See OMI command description for detailed information.

Example

Command:

OMS_13<CR><LF> – set Statistics mode

Response:

OMS_OK<CR><LF> – Statistics mode selected

OMG - Give current working mode

Command gives current working mode for a given device.

Format: **OMG** <CR><LF>

Accessible responses:

OMG_n_OK <CR><LF> – command completed, current working mode is given

OMG_I <CR><LF> – command understood but not accessible at this moment

n – parameter, decimal value specifying working mode number. See OMI command description for detailed information.

Example

Command:

OMG<CR><LF> – give current working mode

Response:

OMG_13_OK<CR><LF> – the device currently operates in Statistics mode

Send all implemented commands

Format: **PC CR LF**

Accessible responses:

PC_A_ "Z,T,S,SI,SU,SUI,C1,C0,CU1,CU0,DH,ODH,UH,OUH,OT,UT, LOGIN,LOGOUT,PC" - command carried out, terminal has sent all implemented commands.

BN – Give balance type

Format: **BN <CR><LF>**

Accessible responses:

BN_A_ "x" <CR><LF> - command understood, balance type given as a response
BN_I <CR><LF> - command understood but not accessible at this moment

x – series of types for a particular balance (in between inverted commas), with general balance type in front

Example:

Command:

BN <CR><LF> – give balance type

Response:

BN_A_ "AS" – balance type – "AS R"

FS – Give Max capacity

Format: **FS <CR><LF>**

Accessible responses:

FS_A_ "x" <CR><LF> - command understood, Max capacity given as a response
FS_I <CR><LF> - command understood but not accessible at this moment

x – Max value of reading units (in between inverted commas)

Example:

Command:

FS <CR><LF> – give Max value for a balance

Response:

FS_A_ "220.0000" – Max capacity of a balance – "220 g"

RV – Give program version

Format: **RV <CR><LF>**

Accessible responses:

- RV_A_“x” <CR><LF>** - command understood, program version given as a response
- RV_I <CR><LF>** - command understood but not accessible at this moment

x – program version (in between inverted commas)

Example:

Command:

RV <CR><LF> – give program number

Response:

RV_A_“r.3.0.9” – program version – “r.3.0.9”

A – Set AUTOZERO function

Format: **A_n <CR><LF>**

Accessible responses:

- A_OK <CR><LF>** - command carried out
- A_E <CR><LF>** - an error occurred on command carrying out, no parameter available or incorrect format
- A_I <CR><LF>** - command understood but not accessible at this moment

n – parameter, decimal value determining autozero settings

n → 0 – autozero on

1 – autozero off

Caution:

Command changes settings for a current working mode.

Example:

Command:

A_1 <CR><LF> – turn autozero function on

Response:

A_OK <CR><LF> – autozero function is on

AUTOZERO function operates until it is turned off by A 0 command.

EV – Set ambient conditions state

Format: **EV_n <CR><LF>**

Accessible responses:

- EV_OK <CR><LF>** - command carried out
- EV_E <CR><LF>** - an error occurred on command

EV_I <CR><LF> carrying out, no parameter available or incorrect format
- command understood but not accessible at this moment

n – parameter, decimal value determining ambient conditions state
n → 0 – stable ambient conditions
1 – unstable ambient conditions

Caution:
Command changes settings for a current working mode.

Example:

Command:

EV_1 <CR><LF> – set value 'stable' for ambient conditions option

Response:

EV_OK <CR><LF> – ambient conditions option set to value 'stable'

<AMBIENT CONDITIONS> parameter is set to value <STABLE> until command EV 0 swaps it to value <UNSTABLE>.

FIS – Set filter

FIS – (Filter, Set)

Command overview:

Command lets the user set filter for a particular device.

Format: **FIS_n <CR><LF>**

Accessible responses:

FIS_OK <CR><LF>	- command carried out
FIS_E <CR><LF>	- an error occurred on command carrying out, no parameter available or incorrect format
FIS_I <CR><LF>	- command understood but not accessible at this moment

n – parameter, decimal value determining filter number
n → 1 – very fast
2 – fast
3 – average
4 – slow
5 – very slow

Caution:

The numbering is assigned to a particular filter name and it is identical for all balance types.

The command changes settings for a current working mode if, for a particular balance type, filter settings are assigned to the working mode.

Example:

Command:

FIS_1 <CR><LF> - set average filter

Response:

FIS_OK <CR><LF> - average filter has been set

ARS – Set value release

ARS – (Approval Result, Set)

Command overview:

Command lets the user set value release options for a particular device.

Format: **ARS_n <CR><LF>**

Accessible responses:

ARS_OK <CR><LF>	- command carried out
ARS_E <CR><LF>	- an error occurred on command carrying out, no parameter available or incorrect format
ARS_I <CR><LF>	- command understood but not accessible at this moment

n – parameter, decimal value determining value release options

n → 1 – fast

2 – fast + reliable

3 – reliable

Caution:

The numbering is assigned to a particular value release option and it is identical for all balance types.

The command changes settings for a current working mode if, for a particular balance type, value release settings are assigned to the working mode.

Example:

Command:

ARS_1 <CR><LF> - set value release parameter to fast+reliable option

Response:

ARS_OK <CR><LF> - fast+reliable option has been set

LDS – Set last digit

LDS – (Last Digit, Set)

Command overview:

Command lets the user set last digit for a particular device.

Format: **LDS_n <CR><LF>**

Accessible responses:

LDS_OK <CR><LF>	- command carried out
LDS_E <CR><LF>	- an error occurred on command

LDS_I <CR><LF> carrying out, no parameter available or incorrect format
 - command understood but not accessible at this moment

n – parameter, decimal value determining last digit settings
 n → 1 – always
 2 – never
 3 – when stable

Caution:

The numbering is assigned to a particular last digit option and it is identical for all balance types.

The command changes settings for a current working mode if, for a particular balance type, last digit settings are assigned to the working mode.

Example:

Command:

LDS_1 <CR><LF> – set last digit option to value 'always'

Response:

LDS_OK <CR><LF> – 'always' value has been set

27.3. Manual printout / Automatic printout

Moisture analyzer MA 3Y series enables generating manual or automatic printouts.

- Manual printout: press  key on stabilization of indication (measurement result),
- Automatic printout is generated automatically, in accordance to the settings of automatic printout (*see point 11.6 of this user manual*).

The content of a printout depends on setting in menu <Standard printout> - <Weighing printout template> (*see point 16.5 of this user manual*).

Format of mass printout:

1	2	3	4 -12	13	14	15	16	17	18
stability marker	space	character	mass	space	unit			CR	LF

Stability marker [space] if stable
 [?] if unstable
 [!] air buoyancy correction mode is enabled
 [^] if error of exceeding range to + occurs
 [v] if error of exceeding range to - occurs

Character [space] for positive values
 [-] for negative values
 Mass 9 characters with decimal point and right justification
 Unit 3 characters with left justification

Example:

_____ 1 8 3 2 . 0 _ g _ _ CR LF – a printout generated by a moisture analyzer on pressing  key, according to settings of <Weighing printout template> option:

N (number of measurements)	NO	Universal variable 1 ... 5	NO
Date	NO	Net	NO
Time	NO	Tare	NO
Level status	NO	Gross	NO
Client	NO	Current result	NO
Warehouse	NO	Supplementary unit	NO
Product	NO	Mass	YES
Packaging	NO	Non-standard printout	NO

28. CONNECTING PERIPHERAL DEVICES

Moisture analyzer MA 3Y series can cooperate with the following peripheral devices:

- Computer,
- Receipt printer: KAFKA, EPSON,
- PCL printer PCL,
- Additional display,
- Barcode scanner,
- An optional peripheral device operating in communication protocol ASCII.

29. DIAGRAMS OF CONNECTING CABLES

Caution:

Cable „Balance – Ethernet” is a regular network cable with slot jest RJ45 on both ends.

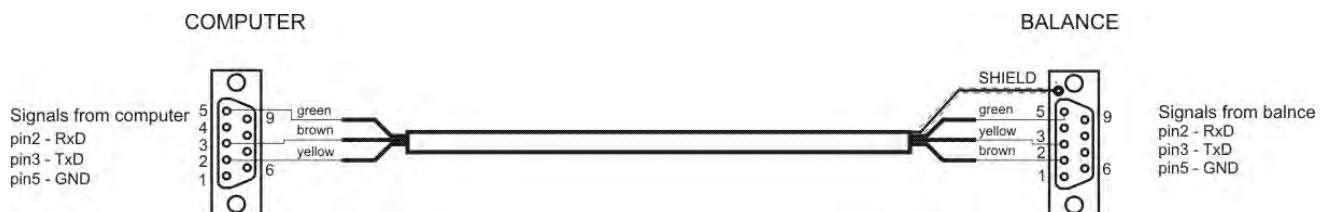

Cable: moisture analyzer - computer (RS232)

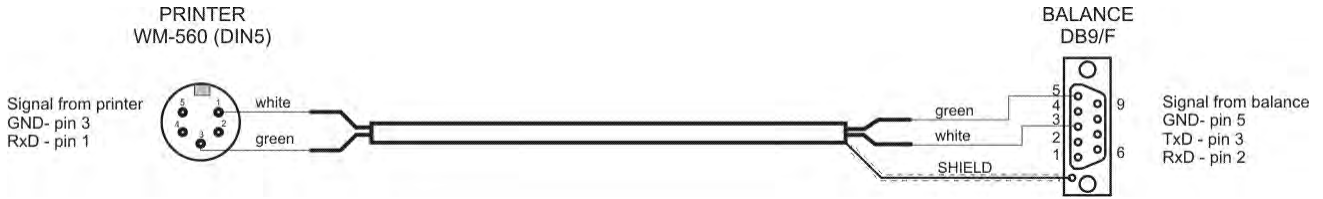

Cable: moisture analyzer - printer KAFKA

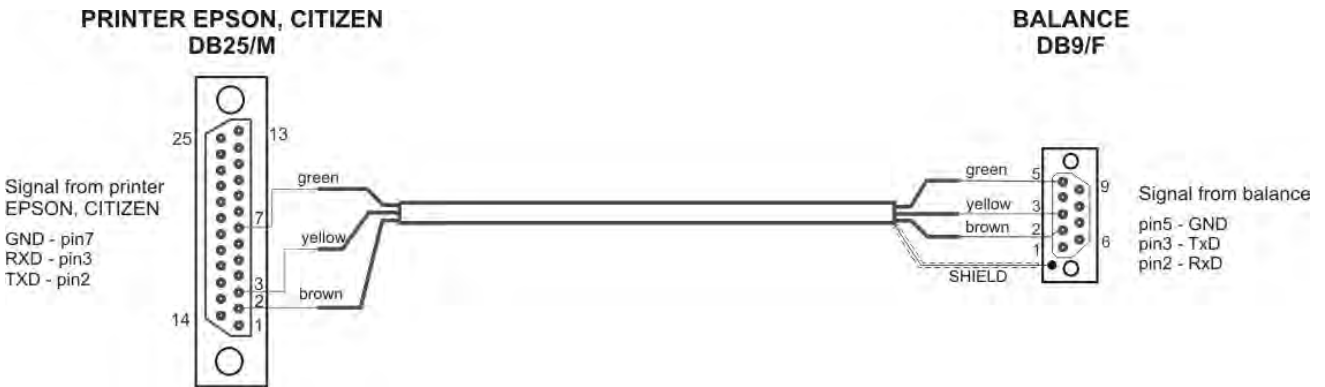

Cable: moisture analyzer – printer EPSON

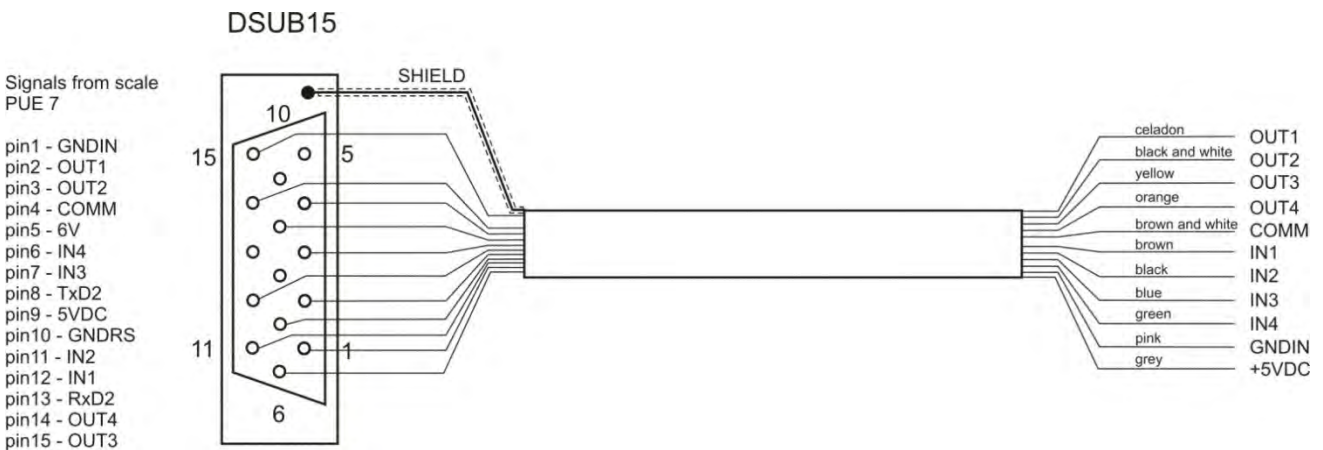

Cable: IN / OUT

30. ERROR MESSAGES

- Err2 - Value beyond zero range,
- Err3 - Value beyond tare range,
- Err8 - Tarring / Zeroing operation time exceeded,
- NULL- - Zero value from converter,
- FULL- - Measurement range (Max. capacity) exceeded,
- LH- - Start mass error,
- no level- - moisture analyzer is not leveled

31. MOISTURE ANALYZER MAINTENANCE ACTIVITIES

This section of the user manual describes procedures of maintaining a moisture analyzer MA 3Y series in good condition, and means of replacing faulty components (fuses).

31.1. Cleaning moisture analyzer components

In order to ensure required measuring accuracy, the moisture analyzer has to be used and stored in clean conditions.

While cleaning the moisture analyzer, precautions provided in this section of the user manual must be obeyed.



REMEMBER, before initiating any maintenance or cleaning activities of moisture analyzer's inner parts, switch off the moisture analyzer by pressing ON/OFF key on terminal's overlay, and make sure the power cord of the moisture analyzer is unplugged from mains!

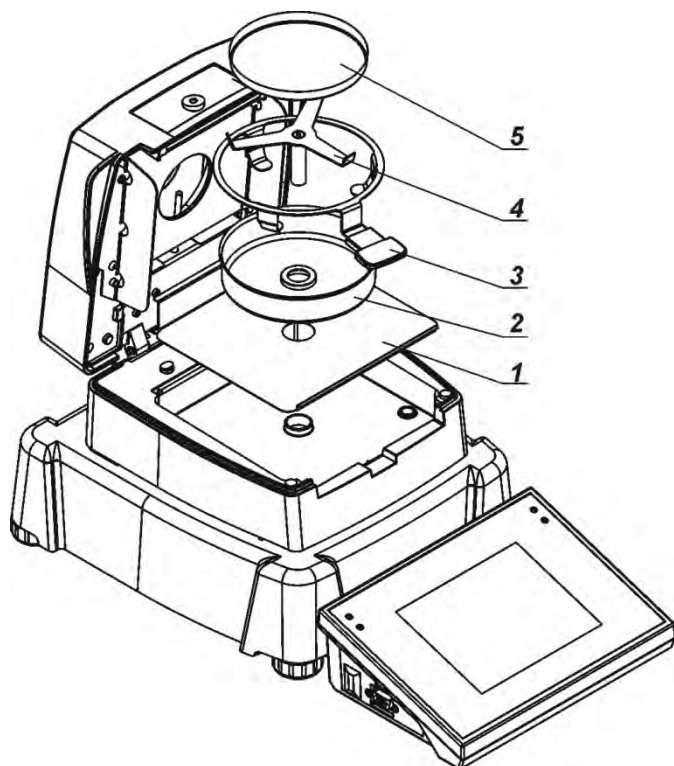

Open moisture analyzer's lid and take out all components of the drying chamber:
disposable pan (5),
cross-shaped holder (4),
pan handle (3),
drying pan shield (2),
insert of the drying chamber base (1).

Clean the moisture analyzer using soft fabrics (diaper, chamois, etc.) and non-aggressive cleaning agents.

Do not use any abrasive agents or solvents to clean the moisture analyzer, as it may cause damage to the device and its components.

After cleaning, thoroughly dry each of moisture analyzer's components.
Do not allow any contamination or liquid to fall into the moisture analyzer.

Assembly cleaned and dried components in accordance with above scheme.

31.2. Temperature sensor cleaning

In order to ensure correct temperature measurements during testing procedure, pay special attention to cleanness of the temperature sensor. Any cleaning activities of the temperature sensor should be carried out with maintaining special precautions.



REMEMBER, before initiating any maintenance or cleaning activities of moisture analyzer's inner parts, switch off the moisture analyzer by pressing ON/OFF key on terminal's overlay, and make sure the power cord of the moisture analyzer is unplugged from mains!

Temperature sensor should be cleaned using a soft fabric with addition of a mild detergent. Do not use any abrasive agents or solvents, as they may damage the temperature sensor.

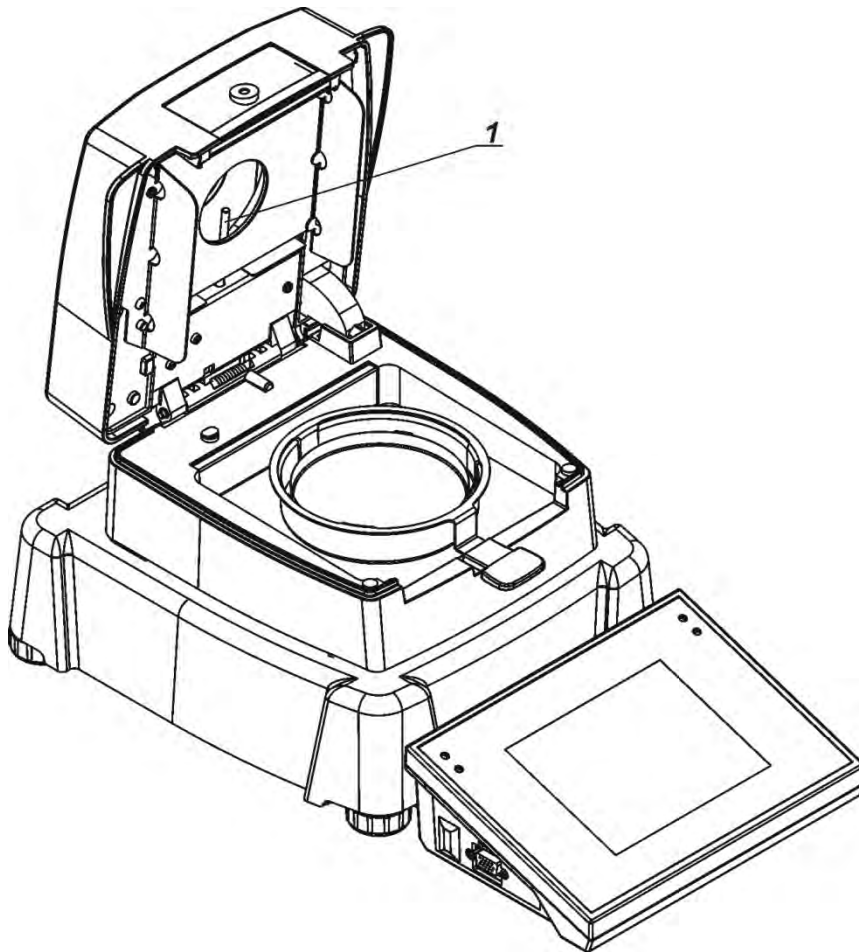

While cleaning make sure not to touch the heating filament, as it may damage it.

If necessary it is permissible to clean filament's shield. Clean the filament's shield using a soft and dry fabric only. Do not touch the filament while cleaning the shield.

31.3. Replacing the fuses

If after plugging to mains, a signal diode on moisture analyzer's display does not light up (no display reaction), then possibly one of the fuses (or both) is blown.

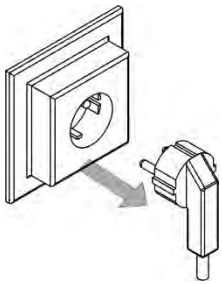

REMEMBER, before initiating any activities relates to fuse replacement switch off the moisture analyzer by pressing ON/OFF key on terminal's overlay, and make sure the power cord of the moisture analyzer is unplugged from mains!

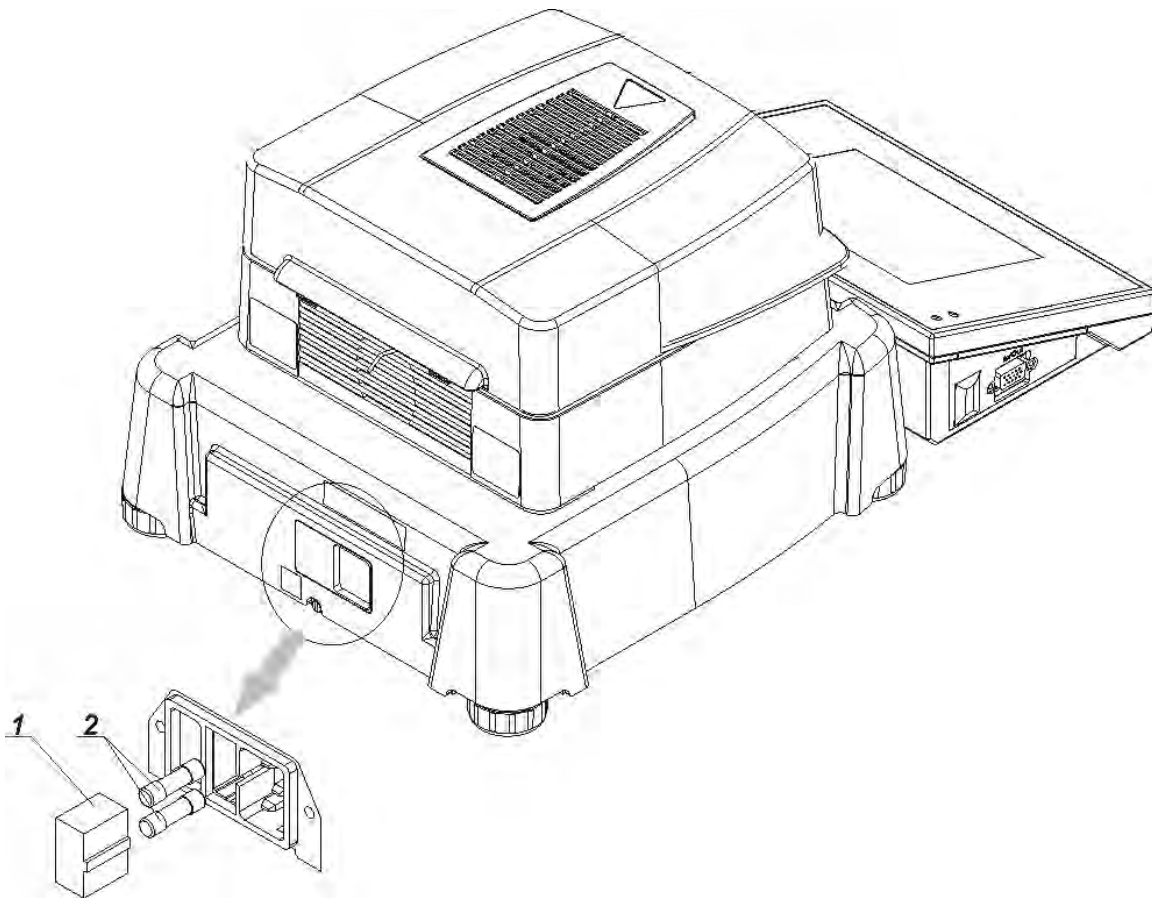

A moisture analyzer MA 3Y series features two **glass tabular fuses 5x20, slow-blow (T); 3.15A 250VAC**, which protect moisture analyzer's electric circuits.

Fuse replacement procedure:

1. Take the fuse base (1) out of its mounting, which is located next to power cord socket.
2. Take a fuse or fuses (2) out of the fuse base.
3. Replace a fuse or fuses with new ones.
4. Assembly the fuse base featuring new fuses into the mounting.
5. Plug the moisture analyzer to mains.

31.4. Troubleshooting

Problem: no reaction to pressing main switch on/off key (no display reaction).

Probable cause:

- No voltage in mains
- Damaged power cord
- Damaged fuse of the moisture analyzer
- Moisture analyzer defect

Problem: too long pending time for drying process finish.

Probable cause:

- Selected finish mode of drying process is incorrect. Carry out experimental tests to select a proper means of finish mode.

Problem: measurements are not repeatable

Probable cause:

- non-uniform sample content. Prepare the sample from larger amount of substance.
- drying time is too short. Change finish mode criteria of the testing process.
- drying temperature is too high, causing sample's oxidizing. Lower drying temperature.
- tested sample boils. Lower the drying temperature.
- the temperature sensor is contaminated or defected. Clean the temperature sensor.
- the workbench on which the moisture analyzer is located is unstable. Change the location of instrument's operation.
- - the ambient area is incompatible with the requirements (vibrations, drafts, etc.). Change the ambient conditions for compatible ones according to the guidelines of this user manual.

32. ADDITIONAL EQUIPMENT

Type	Name
P0136	RS232 cable for KAFKA printer
P0151	RS232 cable for EPSON printer
KAFKA	Thermal printer
EPSON	Dot matrix printer
	PCL printer
CK-01	Transponder card scanner
LS2208	Barcode scanner
AP2-1	Power loop output
SAL	Anti-vibration table for laboratory balances
	PC keyboard USB type

Computer software:

- "PW-WIN",
- "RAD-KEY"
- "E2R-MOISTURE ANALYZER".

33. APPENDIX A – Variables for printouts

33.1. List of variables

Caution:

Each of defined variables must be contained in braces: {x}, where x – stands for variable number.

List of variables is accessible in the system for defining the look of standard printout templates and data displayed in the grey coloured workspace:

Symbol	Variable description
{0} ¹⁾	Standard printout in adjustment unit
{1} ¹⁾	Standard printout in current measuring unit
{2}	Date
{3}	Time
{4}	Date and time
{5}	Working modes
{6}	Net mass in current measuring unit
{7}	Net mass in adjustment unit
{8}	Gross mass
{9}	Tare
{10}	Current measuring unit
{11}	Adjustment unit
{12}	Low threshold
{13}	High threshold
{15}	Statistics: Number
{16}	Statistics: Sum
{17}	Statistics: Mean
{18}	Statistics: Minimum
{19}	Statistics: Maximum
{20}	Statistics: SDV
{21}	Statistics: D
{22}	Statistics: RDV
{26}	Result control
{27}	Value
{28}	Level status

{30}	Gross value
{31}	Weighing platform no.
{32}	Factory no.
{33}	Balance reading unit
{34}	Range
{35}	Parts counting: Mass of a standard
{36}	Percent setup: Reference mass
{38}	Universal variable: Name
{39}	Universal variable: Value
{43}	Net mass in supplementary unit
{44}	Supplementary unit
{45}	Target value
{46}	Tolerance
{47}	Difference
{48}	Balance type
{50}	Product: Name
{51}	Product: Code
{52}	Product: EAN code
{53}	Product: Mass
{54}	Product: Tare
{55}	Product: Price
{56}	Product: Minimum
{57}	Product: Maximum
{58} ²⁾	Product: PGC mode
{59}	Product: Shelf-life time in days
{60}	Product: VAT
{61}	Product: Date
{62}	Product: Shelf-life time
{63}	Product: Density
{64}	Product: Ingredients
{65}	Product: Description
{66}	Product: Tolerance

{75}	User: Name
{76}	User: Code
{77}	User: Access level
{80}	Packaging: Name
{81}	Packaging: Code
{82}	Packaging: Mass
{85}	Client: Name
{86}	Client: Code
{87}	Client: VAT no.
{88}	Client: Address
{89}	Client: Postal code
{90}	Client: City
{91}	Client: Discount
{100} ²⁾	PGC Report: Batch number
{101} ²⁾	PGC Report: Start date
{102} ²⁾	PGC Report: End date
{103} ²⁾	PGC Report: Result
{104} ²⁾	PGC Report: Batch quantity
{105} ²⁾	PGC Report: Number of measurements
{106} ²⁾	PGC Report: Value of T1 error
{107} ²⁾	PGC Report: Value of 2T1 error
{108} ²⁾	PGC Report: Number of T1 errors
{109} ²⁾	PGC Report: Permissible number of T1 errors
{110} ²⁾	PGC Report: Number of 2T1 errors
{111} ²⁾	PGC Report: Sum
{112} ²⁾	PGC Report: Min
{113} ²⁾	PGC Report: Max
{114} ²⁾	PGC Report: Average
{115} ²⁾	PGC Report: Average limit
{116} ²⁾	PGC Report: Standard deviation
{117} ²⁾	PGC Report: Measurements
{118} ²⁾	PGC Report: Unit
{119} ²⁾	PGC Report: Report no.
{120} ²⁾	Average Tare Report: Date

{121} ²⁾	Average Tare Report: Result
{122} ²⁾	Average Tare Report: Standard deviation
{123} ²⁾	Average Tare Report: 0,25T1
{124} ²⁾	Average Tare Report: Number of measurements
{125} ²⁾	Average Tare Report: Measurements
{126} ²⁾	Average Tare Report: Report no.
{130}	Warehouse: Name
{131}	Warehouse: Code
{132}	Warehouse: Description
{140}	Additional display
{141}	Additional display: WD
{142}	Additional display: WWG
{143}	Hex
{144}	Hex UTF-8
{146}	Gross mass in current measuring unit
{147}	Tare in current measuring unit
{150}	PCL printer: Page offset
{151}	Epson printer: Paper cut
{165} ²⁾	Formulation: Name
{166} ²⁾	Formulation: Code
{167} ²⁾	Formulation: Number of ingredients
{168} ²⁾	Formulation: Sum
{169} ²⁾	Formulation: Ingredient
{170} ²⁾	Formulation: Ingredient no.
{175} ²⁾	Report from formulation: Start date
{176} ²⁾	Report from formulation: End date
{177} ²⁾	Report from formulation: Sum
{178} ²⁾	Report from formulation: Target value
{179} ²⁾	Report from formulation: Difference
{180} ²⁾	Report from formulation: Number of measurements
{181} ²⁾	Report from formulation: Status

{182} ²⁾	Report from formulation: Measurements
{188} ²⁾	Ingredient: Target mass
{189} ²⁾	Ingredient: Difference
{190} ²⁾	Comparator: Report no.
{191} ²⁾	Comparator: Start date
{192} ²⁾	Comparator: End date
{193} ²⁾	Comparator: Order no.
{194} ²⁾	Comparator: Tested standard no.
{195} ²⁾	Comparator: Difference
{196} ²⁾	Comparator: List of Measurements
{197} ²⁾	Comparator: Mean difference
{198} ²⁾	Comparator: Standard deviation
{199} ²⁾	Comparator: Number of cycles
{200} ²⁾	Comparator: Method
{201} ²⁾	Comparator: Min temperature
{202} ²⁾	Comparator: Max temperature
{203} ²⁾	Comparator: Min Humidity
{204} ²⁾	Comparator: Max Humidity
{205} ²⁾	Comparator: Min Pressure
{206} ²⁾	Comparator: Max Pressure
{207} ²⁾	Comparator: Task
{208} ²⁾	Comparator: Selected Task
{209} ²⁾	Comparator: Measurements
{210}	Adjustment history: Type of adjustment
{211}	Adjustment history: Nominal mass
{212}	Adjustment history: Current mass
{213}	Adjustment history: Difference
{214}	Adjustment history: Temperature
{215}	Adjustment history: Level status
{216}	Adjustment history: Weighing platform no.
{220} ²⁾	Mass control: Start date
{221} ²⁾	Mass control: End date
{222} ²⁾	Mass control: Lot no.

{223} ²⁾	Mass control: Average
{224} ²⁾	Mass control: Standard deviation
{225} ²⁾	Mass control: Standard quantity
{226} ²⁾	Mass control: Measurements
{227} ²⁾	Mass control: Report no.
{228} ²⁾	Mass control: Number of T2M error
{229} ²⁾	Mass control: Number of T1M error
{230} ²⁾	Mass control: Number of T1P error
{231} ²⁾	Mass control: Number of T2P error
{232} ²⁾	Mass control: T2- threshold
{233} ²⁾	Mass control: T1- threshold
{234} ²⁾	Mass control: T1+ threshold
{235} ²⁾	Mass control: T2+ threshold
{236} ²⁾	Mass control: T2- threshold value
{237} ²⁾	Mass control: T1- threshold value
{238} ²⁾	Mass control: T1+ threshold value
{239} ²⁾	Mass control: T2+ threshold value
{240} ²⁾	Mass control: Average in percent (DX)
{241} ²⁾	Mass control: Standard deviation in percent
{250} ²⁾	Density: Start date
{251} ²⁾	Density: End date
{252} ²⁾	Density: Procedure
{253} ²⁾	Density: Standard liquid
{254} ²⁾	Density of standard liquid
{255} ²⁾	Density: Temperature if standard liquid
{256} ²⁾	Density: Plunger volume
{257} ²⁾	Density: Density determined
{258} ²⁾	Density: Unit
{259} ²⁾	Density: Sample no.
{260} ²⁾	Density: Weighing 1
{261} ²⁾	Density: Weighing 2
{263} ²⁾	Density: Volume
{266} ²⁾	Density: Mass of steel standard
{267} ²⁾	Density: Mass of aluminum standard

{268} ²⁾	Density: Density of steel standard
{269} ²⁾	Density: Density of aluminum standard
{275}	Ambient conditions report: Date and time
{276}	Ambient conditions report: Temperature THB
{277}	Ambient conditions report: Humidity THB
{278}	Ambient conditions report: Temperature 1
{279}	Ambient conditions report: Temperature 2
{280}	Ambient conditions report: Pressure THB
{281}	Ambient conditions report: Air density
{282}	Ambient conditions report: Humidity
{283}	Ambient conditions report: Pressure
{285} ²⁾	Mass Comparator: (Reference) Standards: Name
{286} ²⁾	Mass Comparator: (Reference) Standards: Code
{287} ²⁾	Mass Comparator: (Reference) Standards: Class
{288} ²⁾	Mass Comparator: (Reference) Standards: Factory no.
{289} ²⁾	Mass Comparator: (Reference) Standards: Mass
{290} ²⁾	Mass Comparator: (Reference) Standards: Set no.
{295} ²⁾	Animal weighing: Threshold
{296} ²⁾	Animal weighing: Averaging time
{300} ²⁾	Tasks: Name
{301} ²⁾	Tasks: Code
{302} ²⁾	Tasks: Class
{303} ²⁾	Tasks: Mass
{304} ²⁾	Tasks: Order no.
{305} ²⁾	Tasks: Tested standard no.
{310} ²⁾	Pipettes: Name
{311} ²⁾	Pipettes: Code
{312} ²⁾	Pipettes: Model
{313} ²⁾	Pipettes Tips
{314} ²⁾	Pipettes: Nominal volume
{315} ²⁾	Pipettes: Minimum volume
{316} ²⁾	Pipettes: Number of channels

{317} ²⁾	Pipettes: Type
{318} ²⁾	Pipettes: Volume type
{319} ²⁾	Pipettes: Tested volumes
{325} ²⁾	Pipette calibration report: Serial no.
{326} ²⁾	Pipette calibration report: Start date
{327} ²⁾	Pipette calibration report: End date
{328} ²⁾	Pipette calibration report: Number of measurements
{329} ²⁾	Pipette calibration report: Work with ISO 8655
{330} ²⁾	Pipette calibration report: Status
{331} ²⁾	Pipette calibration report: Temperature
{332} ²⁾	Pipette calibration report: Humidity
{333} ²⁾	Pipette calibration report: Pressure
{334} ²⁾	Pipette calibration report: Water temperature
{335} ²⁾	Pipette calibration report: Z coefficient
{336} ²⁾	Pipette calibration report: Statistics
{337} ²⁾	Pipette calibration report: Measurements and statistics
{338} ²⁾	Pipette calibration report: Channel number
{340} ²⁾	Pipette calibration report: Average volume
{341} ²⁾	Pipette calibration report: Systematic error
{342} ²⁾	Pipette calibration report: Random error
{343} ²⁾	Pipette calibration report: Tested volume
{344} ²⁾	Pipette calibration report: Systematic error [%]
{345} ²⁾	Pipette calibration report: Random error [%]
{350} ²⁾	Batch: Name
{351} ²⁾	Batch: Code
{352} ²⁾	Batch: Sample
{353} ²⁾	Batch: Number of samples
{355} ²⁾	Sample: Name
{356} ²⁾	Sample: Status
{357} ²⁾	Sample: Tare
{358} ²⁾	Sample: Temperature
{359} ²⁾	Sample: Humidity
{360} ²⁾	Sample: Pressure

{361} ²⁾	Sample number
{365} ²⁾	Weighing B: Interval
{366} ²⁾	Weighing B: Difference
{367} ²⁾	Weighing B: Difference %
{368} ²⁾	Weighing B: Residue %
{369} ²⁾	Weighing B: Number
{375} ²⁾	Differential weighing: Method
{380}	Drying mode: Name
{381}	Drying program: Code
{385}	Drying mode
{386}	Drying mode parameters
{387}	Finish mode
{388}	Finish mode parameters
{389}	Report from drying process (Drying report): Unit
{390}	Report from drying process (Drying report): Printout interval
{395}	Moisture analyzer: Set temperature
{396}	Moisture analyzer: Current temperature
{397}	Moisture analyzer: Drying time
{398}	Moisture analyzer: Status
{399}	Moisture analyzer: Drying time and result
{400}	Moisture analyzer: Moisture content
{401}	Moisture analyzer: Dryness content
{402}	Moisture analyzer: Moisture/dryness
{403}	Moisture analyzer: heater test – Power [%]

Caution:

- 1) Format of variables {0} and {1} is finished with characters **CR LF**, (i.e. switching to a next line is carried out automatically),
- 2) Variables are not operated by software version: **“Moisture analyzer”**.

33.2. Variables formatting

Moisture analyzer MA 3Y series enables random formatting of numerical variables, text variables and date which are dedicated for printing, and which are displayed in the grey coloured workspace of the display.

Formatting types:

- Variables with left justification,
- Variables with right justification,
- Determining number of characters for printing / displaying,
- Determining number of decimal places for numeric variables,
- Converting the format of date and hour,
- Converting numerical variables into a code type EAN13,
- Converting numerical variables and date into a code type EAN128.

Special formatting signs:

Sign	Description	Example
,	Sign separating variables for formatting	{7,10} – Net mass in adjustment unit with constant length of 10 characters, with right justification
-	Minus sign or left justification	{7,-10} – Net mass in adjustment unit with constant length of 10 characters, with left justification
:	Sign proceeding formatting or time separator (i.e. hours, minutes and seconds)	{7:0.000} – Net mass in adjustment unit always with three decimal places; {3:hh:mm:ss} – Current time in format: hour : minute : second
.	First detected dot in a digit is recognized as separator of integer and decimal parts. Each following dot is ignored.	{55:0.00} – Product's unit price always with two decimal places; {17:0.0000} – Average from measurements, always with four decimal places;
F	Sign formatting digits to a chain of sign in format "-ddd.ddd..." (where: d stands for a single digit, minus is for digits with negative value only) or determining number of decimal places	{7:F2} – Net mass in adjustment unit always with two decimal places; {7,9:F2} – Net mass in adjustment unit always with two decimal places and fixed length of 9 characters with right justification;
V	Formatting mass and quantities derivatives of mass in EAN13 code	{7:V6.3} – Net mass in a form of EAN13 code (6-character code) with three decimal places

Sign	Description	Example
T	Formatting mass and quantities derivatives of mass in EAN128 code	{7:T6.3} – Net mass in a form of EAN128 code with three decimal places;
/	Date separator between days, months and years	{2:yy/MM/dd} – Current date in format: year - month - day, where yy stand for two less meaningful characters of a year;
\	sign "escape" deleting a formatting function from the following sign, so that it is recognized as text	{2:yy\MM\dd} – Current date in format: year / month / day; {2:yy\:MM\:dd} – Current date in format: year : month : day. Should " \ " be used in literal meaning, insert: \\ ;

Application list of formatted variables:

CODE	DESCRIPTION
{7:V6.3}	Net mass in EAN 13 code (6-character code)
{7:V7.3}	Net mass in EAN 13 code (7-character code)
{27:V6.3}	Net value in EAN 13 code (6-character code)
{27:V7.3}	Net value in EAN 13 code (7-character code)
{7:T6.3}	Net mass in EAN 128 code
{8:T6.3}	Gross mass in EAN 128 code
{55:T6.2}	Product price in EAN 128 code
{2:yyMMdd}	Data in EAN 128 code
{61:yyMMdd}	Product data in EAN 128 code
{62:yyMMdd}	Product's shelf-life time in EAN 128 code

34. APPENDIX E - Settings of ZEBRA printers

Baud rate – 9600b/sec
Parity control – none
Bits – 8bit
Stop bits – 1 bit

Data on a printout from a printer regarding RS 232:

Serial port : **96, N, 8, 1**

Means of activating an information (test) printout and carrying out changes in printer's settings is specified in a user manual of ZEBRA printers.

35. APPENDIX F – Communication with barcode scanners

1. For communication with barcode scanners RADWAG moisture analyzers MA 3Y series use RS232 interfaces and simplex transmission (one direction) without handshaking. Only two wires are required for assuring such a transmission. Therefore, used scanners should be equipped in such interface with disabled both hardware and software handshaking.
2. Both moisture analyzers and scanners have the possibility of setting of transmission parameters. Both devices are required to have the same parameters set: baud rate, number of data bits, parity control, stop bits. e.g. 9600,8,N,1 – baud rate 9600 bit/s, data 8-bits, no parity control, 1 stop bit.
3. Barcode scanners can send additional information apart from the expected barcode e.g. symbol denoting type of barcode. It is advisable to disable such information because RADWAG devices and software do not use it.
4. Some RADWAG systems can omit unnecessary information by using parameters that mark the beginning and the length of the code required to analyze.
5. Should a barcode be recognized by a moisture analyzer, it needs to have some particular features. A code requires programming a characteristics prefix and suffix. In a standard accepted by RADWAG, a prefix is a sign (byte) 01 hexadecimal and a suffix is a sign (byte) 0D hexadecimal.
6. Most barcode scanners allow to enable/disable different barcode types.
7. Programming of scanners is usually performed by reading special barcodes or by using an external software tool.

Barcode with required prefix and suffix in hexadecimal format	Barcode without required –fixes in ASCII format	Code type
01 30 30 32 31 30 31 32 36 0D	00210126	EAN-8
01 30 31 32 33 34 35 36 37 38 39 0D	0123456789	KOD 2 Z 5
01 43 4F 44 45 20 33 39 20 54 45 53 54 0D	CODE 39 TEST	CODE 39
01 31 31 30 31 32 33 34 35 36 37 38 39 31 0D	1101234567891	EAN-13
01 43 6F 64 65 20 31 32 38 20 54 65 73 74 0D	CODE 128 Test	CODE 128

36. APPENDIX G – Menu structure

User adjustment

Description	Value
External adjustment	Function
User adjustment	Function
Adjustment test	Function
Report printout	No / Yes
GLP Project . . →→	

	Name	Setting
	» Adjustment	No / Yes
	» Working mode	No / Yes
	» Date	No / Yes
	» Time	No / Yes
	» User	No / Yes
	» Balance type	No / Yes
	» Balance ID	No / Yes
	» Level status	No / Yes
	» Nominal mass	No / Yes
	» Difference	No / Yes
	» Temperature	No / Yes
	» Current mass	No / Yes
	» Empty line	No / Yes
	» Dashes	No / Yes
	» Signature	No / Yes
	» Non-standard printout	No / Yes
Adjustment history	Displays a report from completed external adjustments	

Databases

- Products
- Weighing records
- Clients
- Drying programs
- Reports from drying process (Drying reports)
- Ambient conditions
- Packages
- Warehouses
- Printouts
- Universal variables
- Delete data older than
- Export database of weighing records to file

Communication

Description	Value
COM 1	-
» Baud rate	9600
» Data bits	8
» Stop bits	1
» Parity	No
COM 2	-
» Baud rate	9600
» Data bits	8
» Stop bits	1
» Parity	No
Ethernet	-
» DHCP	No
» IP address	192.168.0.2
» Subnet mask	255.255.255.0
» Default gate	192.168.0.1
Tcp	-
Port	4001

Peripheral devices

Description	Value
Computer	-
» Port	COM 1
» Address	1
» Continuous transmission	No / Yes
» Printout template	Settings
» E2R System	Settings
Printer	
» Port	COM 2
» Code page	1250
» Printouts	Settings
Barcode scanner	
» Port	None / COM 1/ COM 2
» Offset	0
» Code length	0
Transponder card scanner	
Port	None / COM 1/ COM 2
Additional display	
Port	None / COM 1-2 / Tcp
Project	Settings
Ambient conditions module	
Port	None / COM 1-2 / Com internal
Address	3

Inputs / Outputs

Description	Value
Inputs	
» Input 1	Selection
» Input 2	Selection
» Input 3	Selection
» Input 4	Selection
Outputs	

» Output 1	Selection
» Output 2	Selection
» Output 3	Selection
» Output 4	Selection

Access level

Description	Value
Anonymous user	
» Guest	Selection
» User	Selection
» Advanced user	Selection
» Administrator	Selection
Date and time	
» Guest	Selection
» User	Selection
» Advanced user	Selection
» Administrator	Selection
Printouts	
» Guest	Selection
» User	Selection
» Advanced user	Selection
» Administrator	Selection
Databases	
Products	Selection: - Guest - User - Advanced user - Administrator
Clients	
Formulation	
Packages	
Warehouses	
Printouts	
Delete data older than	

Others

Description	Value
Language	Selection

Date and time	Settings
Beep	Selection
Touch screen display calibration	Function
Level control	Selection
Autotest	Selection

User manual no.:
IMMU-10-09-11-17-ENG



RADWAG BALANCES AND SCALES
ADVANCED WEIGHING TECHNOLOGIES

