

HY10.HRP High Resolution Scales

Unrivalled accuracy of weighing large loads in vast range of industrial applications



HY10.HRP
Max: 150 – 2000 kg



HY10.HRP
Max: 16 – 32 kg

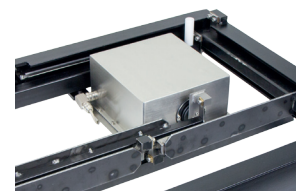

High resolution weighing module in a hermetic housing

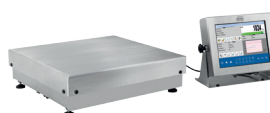

HY10.HRP
Max: 62 – 120 kg



PUE HY10 indicator with 10.1" colour touch panel

Functions

- | | | | | |
|----------------|-----------------------|-----------------------------|----------------------------|-------------------|
| Parts counting | Percent weighing | Statistical quality control | Peak hold | Smart select |
| Dosing | Statistics | Density determination | Totalizing | Alibi memory |
| Checkweighing | Animal weighing | Labelling | Pre-packaged goods control | Replaceable units |
| Formulations | Differential weighing | Transactions | GLP procedures | Multilingual menu |

Features

The Most Precise Weighing Results in Industrial Conditions

Advanced HY10.HRP scale enables fast and precise mass measurements in industrial conditions. The scale enables carrying out measurements with very high resolutions available so far only for laboratory balances.

Reliability and Safety

Robust design and protection system against overloads and mechanical shocks allow to operate different types of loads, ensuring durability and endurance in everyday use.

Versatility of Use

HY10.HRP scale is perfect for applications requiring high accuracy, precision and repeatability of measurement in challenging industrial environment.

Cooperation with PUE HY10 Indicator

The scale can be operated via advanced PUE HY10 indicator controlled by Linux system. Hermetic housing is made of stainless steel.

Uncomplicated Operation and Clear Presentation of Indications

10.1" large colour touch screen ensures excellent readability and comfortable operation. Clear menu and intuitive information arrangement on the display guarantees comfortable operation.

Remote Configuration

Parameters Editor software enables remote indicator operation from anywhere in the world.

Automatic Adjustment

Internal adjustment system guarantees the highest accuracy and reliable measurements results.

Uncomplicated Databases Archiving

An extensive database enables archiving work results and periodic reports, data exchange between indicators and information import and export. Images database allows to assign a graphic to each product.

Technical Specifications

	HY10.16.HRP*
Maximum capacity [Max]	16 kg
Preload	4 kg
Minimum capacity	5 g
Readability [d]	0.1 g
Verification unit [e]	—
Tare range	-16 kg
Repeatability **	0.1 g
Linearity	±0.1 g
Stabilization time ***	2 s
Adjustment	internal
Verification	—
OIML class	—
Platform material	powder-coated aluminium
Weighing pan material	AISI304 stainless steel
Indicator type	PUE HY10
Display	10.1" touch panel
Keyboard	on-screen
Ingress protection - platform	IP 66/67
Ingress protection - indicator	IP 68/69
USB	1 × type A, 1 × MR 4 PIN
RS 232	2
Ethernet	10 / 100 Mbit
IN/OUT	4 × IN, 4 × OUT for (IN – 5-24 VDC, OUT – max 30 VDC, 0,5 ADC)
WiFi®****	802.11 b/g/n
WE12 module****	12IN / 12OUT - cable gland for (IN – 5-24 VDC, OUT – max 30 VDC, 0,5 ADC)
AN module****	4-20mA, 0-20mA current loop; 0-10V voltage loop
PROFIBUS module****	DP SLAVE
PROFINET Module****	1 × type RJ45
RS 232****	1 × hermetic connector
RS 485****	1 × cable gland
Communication protocol	ASCII Text / Modbus RTU / TCP
Power supply	100 ÷ 240 V AC 50 ÷ 60 Hz
Power consumption	21 W
Operating temperature	+10 ÷ +40 °C
Relative humidity *****	40 ÷ 80%
Transport and storage temperature	-10 ÷ +50 °C
Weighing pan dimensions	360 × 280 mm
Indicator dimensions	357 × 275 × 120 mm
Net weight	24.7 kg
Gross weight	28.7 kg
Platform packaging dimensions	550 × 463 × 350 mm
Indicator packaging dimensions	415 × 345 × 225 mm

* MonoBLOCK™ measuring system
 ** repeatability is expressed as a standard deviation from 10 weighing cycles
 *** under optimum ambient conditions
 **** optional indicator design
 ***** non-condensing conditions

Wi-Fi® is a registered trademark of Wi-Fi® Alliance.

Technical Specifications

	HY10.16.HRP.M2.1*	HY10.16.HRP.M2.2*	HY10.16.HRP.M3*
Maximum capacity [Max]	16 kg	16 kg	5 kg / 10 kg / 16 kg
Preload	4 kg	4 kg	4 kg
Minimum capacity	5 g	50 g	10 g / 20 g / 40 g
Readability [d]	0,1 g	1 g	0,5 g / 1 g / 2 g
Verification unit [e]	1 g	1 g	0,5 g / 1 g / 2 g
Tare range	-16 kg	-16 kg	-16 kg
Repeatability **	0,1 g	0,1 g	0,1 g
Linearity	±0,1 g	±0,1 g	±0,1 g
Stabilization time ***	2 s	2 s	2 s
Adjustment	internal	internal	internal
Verification	YES	YES	YES
Maximum quantity of verification units	16000 e	16000 e	10000 e / 10000 e / 8000 e
OIML class	II	II	III
Platform material	powder-coated aluminium	powder-coated aluminium	powder-coated aluminium
Weighing pan material	AISI304 stainless steel	AISI304 stainless steel	AISI304 stainless steel
Indicator type	PUE HY10	PUE HY10	PUE HY10
Display	10.1" touch panel	10.1" touch panel	10.1" touch panel
Keyboard	on-screen	on-screen	on-screen
Ingress protection - platform	IP 66/67	IP 66/67	IP 66/67
Ingress protection - indicator	IP 68/69	IP 68/69	IP 68/69
USB	1 × type A, 1 × MR 4 PIN	1 × type A, 1 × MR 4 PIN	1 × type A, 1 × MR 4 PIN
RS 232	2	2	2
Ethernet	10 / 100 Mbit	10 / 100 Mbit	10 / 100 Mbit
IN/OUT	4 × IN, 4 × OUT for (IN – 5-24 VDC, OUT – max 30 VDC, 0,5 ADC)	4 × IN, 4 × OUT for (IN – 5-24 VDC, OUT – max 30 VDC, 0,5 ADC)	4 × IN, 4 × OUT for (IN – 5-24 VDC, OUT – max 30 VDC, 0,5 ADC)
WiFi®****	802.11 b/g/n	802.11 b/g/n	802.11 b/g/n
WE12 module****	12IN / 12OUT - cable gland for (IN – 5-24 VDC, OUT – max 30 VDC, 0,5 ADC)	12IN / 12OUT - cable gland for (IN – 5-24 VDC, OUT – max 30 VDC, 0,5 ADC)	12IN / 12OUT - cable gland for (IN – 5-24 VDC, OUT – max 30 VDC, 0,5 ADC)
AN module****	4-20mA, 0-20mA current loop; 0-10V voltage loop	4-20mA, 0-20mA current loop; 0-10V voltage loop	4-20mA, 0-20mA current loop; 0-10V voltage loop
PROFIBUS module****	DP SLAVE	DP SLAVE	DP SLAVE
PROFINET Module****	1 × type RJ45	1 × type RJ45	1 × type RJ45
RS 232****	1 × hermetic connector	1 × hermetic connector	1 × hermetic connector
RS 485****	1 × cable gland	1 × cable gland	1 × cable gland
Communication protocol	ASCII Text / Modbus RTU / TCP	ASCII Text / Modbus RTU / TCP	ASCII Text / Modbus RTU / TCP
Power supply	100 ÷ 240 V AC 50 ÷ 60 Hz	100 ÷ 240 V AC 50 ÷ 60 Hz	100 ÷ 240 V AC 50 ÷ 60 Hz
Power consumption	21 W	21 W	21 W
Operating temperature	+10 ÷ +40 °C	+10 ÷ +40 °C	+10 ÷ +40 °C
Relative humidity *****	40 ÷ 80%	40 ÷ 80%	40 ÷ 80%
Transport and storage temperature	-10 ÷ +50 °C	-10 ÷ +50 °C	-10 ÷ +50 °C
Weighing pan dimensions	360 × 280 mm	360 × 280 mm	360 × 280 mm
Indicator dimensions	357 × 275 × 120 mm	357 × 275 × 120 mm	357 × 275 × 120 mm
Net weight	24.7 kg	24.7 kg	24.7 kg
Gross weight	28.7 kg	28.7 kg	28.7 kg
Platform packaging dimensions	550 × 463 × 350 mm	550 × 463 × 350 mm	550 × 463 × 350 mm
Indicator packaging dimensions	415 × 345 × 225 mm	415 × 345 × 225 mm	415 × 345 × 225 mm

* MonoBLOCK™ measuring system
 ** repeatability is expressed as a standard deviation from 10 weighing cycles
 *** under optimum ambient conditions
 **** optional indicator design
 ***** non-condensing conditions

Wi-Fi® is a registered trademark of Wi-Fi® Alliance.

Technical Specifications

	HY10.32.HRP*
Maximum capacity [Max]	32 kg
Preload	4 kg
Minimum capacity	5 g
Readability [d]	0.1 g
Verification unit [e]	—
Tare range	–32 kg
Repeatability **	0.1 g
Linearity	±0.3 g
Stabilization time ***	2 s
Adjustment	internal
Verification	—
OIML class	—
Platform material	powder-coated aluminium
Weighing pan material	AISI304 stainless steel
Indicator type	PUE HY10
Display	10.1" touch panel
Keyboard	on-screen
Ingress protection - platform	IP 66/67
Ingress protection - indicator	IP 68/69
USB	1 × type A, 1 × MR 4 PIN
RS 232	2
Ethernet	10 / 100 Mbit
IN/OUT	4 × IN, 4 × OUT for (IN – 5-24 VDC, OUT – max 30 VDC, 0,5 ADC)
WiFi®****	802.11 b/g/n
WE12 module****	12IN / 12OUT - cable gland for (IN – 5-24 VDC, OUT – max 30 VDC, 0,5 ADC)
AN module****	4-20mA, 0-20mA current loop; 0-10V voltage loop
PROFIBUS module****	DP SLAVE
PROFINET Module****	1 × type RJ45
RS 232****	1 × hermetic connector
RS 485****	1 × cable gland
Communication protocol	ASCII Text / Modbus RTU / TCP
Power supply	100 ÷ 240 V AC 50 ÷ 60 Hz
Power consumption	21 W
Operating temperature	+10 ÷ +40 °C
Relative humidity *****	40 ÷ 80%
Transport and storage temperature	–10 ÷ +50 °C
Weighing pan dimensions	360 × 280 mm
Indicator dimensions	357 × 275 × 120 mm
Net weight	24.7 kg
Gross weight	28.7 kg
Platform packaging dimensions	550 × 463 × 350 mm
Indicator packaging dimensions	415 × 345 × 225 mm

* MonoBLOCK™ measuring system
 ** repeatability is expressed as a standard deviation from 10 weighing cycles
 *** under optimum ambient conditions
 **** optional indicator design
 ***** non-condensing conditions

Technical Specifications

	HY10.32.HRP.M2.1*	HY10.32.HRP.M2.2*	HY10.32.HRP.M3*
Maximum capacity [Max]	32 kg	32 kg	10 kg / 20 kg / 32 kg
Preload	4 kg	4 kg	4 kg
Minimum capacity	5 g	50 g	20 g / 40 g / 100g
Readability [d]	0,1 g	2 g	1 g / 2 g / 5 g
Verification unit [e]	1 g	2 g	1 g / 2 g / 5 g
Tare range	-32 kg	-32 kg	-32 kg
Repeatability **	0,1 g	0,1 g	0,1 g
Linearity	±0,3 g	±0,3 g	±0,3 g
Stabilization time ***	2 s	2 s	2 s
Adjustment	internal	internal	internal
Verification	YES	YES	YES
Maximum quantity of verification units	32000 e	16000 e	10000 e / 10000 e / 6400 e
OIML class	II	II	III
Platform material	powder-coated aluminium	powder-coated aluminium	powder-coated aluminium
Weighing pan material	AISI304 stainless steel	AISI304 stainless steel	AISI304 stainless steel
Indicator type	PUE HY10	PUE HY10	PUE HY10
Display	10.1" touch panel	10.1" touch panel	10.1" touch panel
Keyboard	on-screen	on-screen	on-screen
Ingress protection - platform	IP 66/67	IP 66/67	IP 66/67
Ingress protection - indicator	IP 68/69	IP 68/69	IP 68/69
USB	1 × type A, 1 × MR 4 PIN	1 × type A, 1 × MR 4 PIN	1 × type A, 1 × MR 4 PIN
RS 232	2	2	2
Ethernet	10 / 100 Mbit	10 / 100 Mbit	10 / 100 Mbit
IN/OUT	4 × IN, 4 × OUT for (IN – 5-24 VDC, OUT – max 30 VDC, 0,5 ADC)	4 × IN, 4 × OUT for (IN – 5-24 VDC, OUT – max 30 VDC, 0,5 ADC)	4 × IN, 4 × OUT for (IN – 5-24 VDC, OUT – max 30 VDC, 0,5 ADC)
WiFi®****	802.11 b/g/n	802.11 b/g/n	802.11 b/g/n
WE12 module****	12IN / 12OUT - cable gland for (IN – 5-24 VDC, OUT – max 30 VDC, 0,5 ADC)	12IN / 12OUT - cable gland for (IN – 5-24 VDC, OUT – max 30 VDC, 0,5 ADC)	12IN / 12OUT - cable gland for (IN – 5-24 VDC, OUT – max 30 VDC, 0,5 ADC)
AN module****	4-20mA, 0-20mA current loop; 0-10V voltage loop	4-20mA, 0-20mA current loop; 0-10V voltage loop	4-20mA, 0-20mA current loop; 0-10V voltage loop
PROFIBUS module****	DP SLAVE	DP SLAVE	DP SLAVE
PROFINET Module****	1 × type RJ45	1 × type RJ45	1 × type RJ45
RS 232****	1 × hermetic connector	1 × hermetic connector	1 × hermetic connector
RS 485****	1 × cable gland	1 × cable gland	1 × cable gland
Communication protocol	ASCII Text / Modbus RTU / TCP	ASCII Text / Modbus RTU / TCP	ASCII Text / Modbus RTU / TCP
Power supply	100 ÷ 240 V AC 50 ÷ 60 Hz	100 ÷ 240 V AC 50 ÷ 60 Hz	100 ÷ 240 V AC 50 ÷ 60 Hz
Power consumption	21 W	21 W	21 W
Operating temperature	+10 ÷ +40 °C	+10 ÷ +40 °C	+10 ÷ +40 °C
Relative humidity *****	40 ÷ 80%	40 ÷ 80%	40 ÷ 80%
Transport and storage temperature	-10 ÷ +50 °C	-10 ÷ +50 °C	-10 ÷ +50 °C
Weighing pan dimensions	360 × 280 mm	360 × 280 mm	360 × 280 mm
Indicator dimensions	357 × 275 × 120 mm	357 × 275 × 120 mm	357 × 275 × 120 mm
Net weight	24.7 kg	24.7 kg	24.7 kg
Gross weight	28.7 kg	28.7 kg	28.7 kg
Platform packaging dimensions	550 × 463 × 350 mm	550 × 463 × 350 mm	550 × 463 × 350 mm
Indicator packaging dimensions	415 × 345 × 225 mm	415 × 345 × 225 mm	415 × 345 × 225 mm

* MonoBLOCK™ measuring system
 ** repeatability is expressed as a standard deviation from 10 weighing cycles
 *** under optimum ambient conditions
 **** optional indicator design
 ***** non-condensing conditions

Wi-Fi® is a registered trademark of Wi-Fi® Alliance.

Technical Specifications

	HY10.62.HRP
Maximum capacity [Max]	62 kg
Preload	30 kg
Minimum capacity	25 g
Readability [d]	0.5 g
Verification unit [e]	—
Tare range	-62 kg
Repeatability **	0.3 g
Linearity	±1 g
Stabilization time ***	3 s
Adjustment	internal
Verification	—
OIML class	—
Platform material	St3S powder-coated steel
Weighing pan material	AISI304 stainless steel
Indicator type	PUE HY10
Display	10.1" touch panel
Keyboard	on-screen
Ingress protection - platform	IP 66/67
Ingress protection - indicator	IP 68/69
USB	1 × type A, 1 × MR 4 PIN
RS 232	2
Ethernet	10 / 100 Mbit
IN/OUT	4 × IN, 4 × OUT for (IN – 5-24 VDC, OUT – max 30 VDC, 0,5 ADC)
WiFi®****	802.11 b/g/n
WE12 module****	12IN / 12OUT - cable gland for (IN – 5-24 VDC, OUT – max 30 VDC, 0,5 ADC)
AN module****	4-20mA, 0-20mA current loop; 0-10V voltage loop
PROFIBUS module****	DP SLAVE
PROFINET Module****	1 × type RJ45
RS 232****	1 × hermetic connector
RS 485****	1 × cable gland
Communication protocol	ASCII Text / Modbus RTU / TCP
Power supply	100 ÷ 240 V AC 50 ÷ 60 Hz
Power consumption	21 W
Operating temperature	+10 ÷ +40 °C
Relative humidity *****	40 ÷ 80%
Transport and storage temperature	-10 ÷ +50 °C
Weighing pan dimensions	500 × 500 mm
Indicator dimensions	357 × 275 × 120 mm
Net weight	37 kg
Gross weight	52 kg
Platform packaging dimensions	700 × 700 × 295 mm
Indicator packaging dimensions	415 × 345 × 225 mm

* MonoBLOCK™ measuring system
 ** repeatability is expressed as a standard deviation from 10 weighing cycles
 *** under optimum ambient conditions
 **** optional indicator design
 ***** non-condensing conditions

Technical Specifications

	HY10.62.HRP.M2.1	HY10.62.HRP.M2.2	HY10.62.HRP.M3
Maximum capacity [Max]	62 kg	62 kg	20 kg / 50 kg / 62 kg
Preload	30 kg	30 kg	30 kg
Minimum capacity	50 g	100 g	40 g / 100 g / 200 g
Readability [d]	1 g	2 g	2 g / 5 g / 10 g
Verification unit [e]	10 g	2 g	2 g / 5 g / 10 g
Tare range	-62 kg	-62 kg	-62 kg
Repeatability **	0,3 g	0,3 g	0,3 g
Linearity	±1 g	±1 g	±1 g
Stabilization time ***	3 s	3 s	3 s
Adjustment	internal	internal	internal
Verification	YES	YES	YES
Maximum quantity of verification units	6200 e	31000 e	10000 e / 10000 e / 6200 e
OIML class	II	II	III
Platform material	St3S powder-coated steel	St3S powder-coated steel	St3S powder-coated steel
Weighing pan material	AISI304 stainless steel	AISI304 stainless steel	AISI304 stainless steel
Indicator type	PUE HY10	PUE HY10	PUE HY10
Display	10.1" touch panel	10.1" touch panel	10.1" touch panel
Keyboard	on-screen	on-screen	on-screen
Ingress protection - platform	IP 66/67	IP 66/67	IP 66/67
Ingress protection - indicator	IP 68/69	IP 68/69	IP 68/69
USB	1 × type A, 1 × MR 4 PIN	1 × type A, 1 × MR 4 PIN	1 × type A, 1 × MR 4 PIN
RS 232	2	2	2
Ethernet	10 / 100 Mbit	10 / 100 Mbit	10 / 100 Mbit
IN/OUT	4 × IN, 4 × OUT for (IN – 5-24 VDC, OUT – max 30 VDC, 0,5 ADC)	4 × IN, 4 × OUT for (IN – 5-24 VDC, OUT – max 30 VDC, 0,5 ADC)	4 × IN, 4 × OUT for (IN – 5-24 VDC, OUT – max 30 VDC, 0,5 ADC)
WiFi®****	802.11 b/g/n	802.11 b/g/n	802.11 b/g/n
WE12 module****	12IN / 12OUT - cable gland for (IN – 5-24 VDC, OUT – max 30 VDC, 0,5 ADC)	12IN / 12OUT - cable gland for (IN – 5-24 VDC, OUT – max 30 VDC, 0,5 ADC)	12IN / 12OUT - cable gland for (IN – 5-24 VDC, OUT – max 30 VDC, 0,5 ADC)
AN module****	4-20mA, 0-20mA current loop; 0-10V voltage loop	4-20mA, 0-20mA current loop; 0-10V voltage loop	4-20mA, 0-20mA current loop; 0-10V voltage loop
PROFIBUS module****	DP SLAVE	DP SLAVE	DP SLAVE
PROFINET Module****	1 × type RJ45	1 × type RJ45	1 × type RJ45
RS 232****	1 × hermetic connector	1 × hermetic connector	1 × hermetic connector
RS 485****	1 × cable gland	1 × cable gland	1 × cable gland
Communication protocol	ASCII Text / Modbus RTU / TCP	ASCII Text / Modbus RTU / TCP	ASCII Text / Modbus RTU / TCP
Power supply	100 ÷ 240 V AC 50 ÷ 60 Hz	100 ÷ 240 V AC 50 ÷ 60 Hz	100 ÷ 240 V AC 50 ÷ 60 Hz
Power consumption	21 W	21 W	21 W
Operating temperature	+10 ÷ +40 °C	+10 ÷ +40 °C	+10 ÷ +40 °C
Relative humidity *****	40 ÷ 80%	40 ÷ 80%	40 ÷ 80%
Transport and storage temperature	-10 ÷ +50 °C	-10 ÷ +50 °C	-10 ÷ +50 °C
Weighing pan dimensions	500 × 500 mm	500 × 500 mm	500 × 500 mm
Indicator dimensions	357 × 275 × 120 mm	357 × 275 × 120 mm	357 × 275 × 120 mm
Net weight	37 kg	37 kg	37 kg
Gross weight	52 kg	52 kg	52 kg
Platform packaging dimensions	700 × 700 × 295 mm	700 × 700 × 295 mm	700 × 700 × 295 mm
Indicator packaging dimensions	415 × 345 × 225 mm	415 × 345 × 225 mm	415 × 345 × 225 mm

* MonoBLOCK™ measuring system
 ** repeatability is expressed as a standard deviation from 10 weighing cycles
 *** under optimum ambient conditions
 **** optional indicator design
 ***** non-condensing conditions

Wi-Fi® is a registered trademark of Wi-Fi® Alliance.

Technical Specifications

	HY10.120.HRP
Maximum capacity [Max]	120 kg
Preload	10 kg
Minimum capacity	50 g
Readability [d]	1 g
Verification unit [e]	—
Tare range	-120 kg
Repeatability *	0.6 g
Linearity	±2 g
Stabilization time **	3 s
Adjustment	internal
Verification	—
OIML class	—
Platform material	St3S powder-coated steel
Weighing pan material	AISI304 stainless steel
Indicator type	PUE HY10
Display	10.1" touch panel
Keyboard	on-screen
Ingress protection - platform	IP 66/67
Ingress protection - indicator	IP 68/69
USB	1 × type A, 1 × MR 4 PIN
RS 232	2
Ethernet	10 / 100 Mbit
IN/OUT	4 × IN, 4 × OUT for (IN – 5-24 VDC, OUT – max 30 VDC, 0,5 ADC)
WiFi®***	802.11 b/g/n
IN12 module***	12IN / 12OUT - cable gland for (IN – 5-24 VDC, OUT – max 30 VDC, 0,5 ADC)
AN module***	4-20mA, 0-20mA current loop; 0-10V voltage loop
PROFIBUS module***	DP SLAVE
PROFINET Module***	1 × type RJ45
RS 232***	1 × hermetic connector
RS 485***	1 × cable gland
Communication protocol	ASCII Text / Modbus RTU / TCP
Power supply	100 ÷ 240 V AC 50 ÷ 60 Hz
Power consumption	21 W
Operating temperature	+10 ÷ +40 °C
Relative humidity ****	40 ÷ 80%
Transport and storage temperature	-10 ÷ +50 °C
Weighing pan dimensions	500 × 500 mm
Indicator dimensions	357 × 275 × 120 mm
Net weight	37 kg
Gross weight	52 kg
Platform packaging dimensions	700 × 700 × 295 mm
Indicator packaging dimensions	415 × 345 × 225 mm

* repeatability is expressed as a standard deviation from 10 weighing cycles

** under optimum ambient conditions

*** optional indicator design

**** non-condensing conditions

Wi-Fi® is a registered trademark of Wi-Fi® Alliance.

Technical Specifications

	HY10.120.HRP.M2.1	HY10.120.HRP.M2.2	HY10.120.HRP.M3
Maximum capacity [Max]	120 kg	120 kg	50 kg / 100 kg / 120 kg
Preload	10 kg	10 kg	10 kg
Minimum capacity	50 g	250 g	100 g / 200 g / 400 g
Readability [d]	1 g	5 g	5 g / 10 g / 20 g
Verification unit [e]	10 g	5 g	5 g / 10 g / 20 g
Tare range	-120 kg	-120 kg	-120 kg
Repeatability *	0,6 g	0,6 g	0,6 g
Linearity	±2 g	±2 g	±2 g
Stabilization time **	3 s	3 s	3 s
Adjustment	internal	internal	internal
Verification	YES	YES	YES
Maximum quantity of verification units	12000 e	24000 e	10000 e / 10000 e / 6000 e
OIML class	II	II	III
Platform material	St3S powder-coated steel	St3S powder-coated steel	St3S powder-coated steel
Weighing pan material	AISI304 stainless steel	AISI304 stainless steel	AISI304 stainless steel
Indicator type	PUE HY10	PUE HY10	PUE HY10
Display	10.1" touch panel	10.1" touch panel	10.1" touch panel
Keyboard	on-screen	on-screen	on-screen
Ingress protection - platform	IP 66/67	IP 66/67	IP 66/67
Ingress protection - indicator	IP 68/69	IP 68/69	IP 68/69
USB	1 × type A, 1 × MR 4 PIN	1 × type A, 1 × MR 4 PIN	1 × type A, 1 × MR 4 PIN
RS 232	2	2	2
Ethernet	10 / 100 Mbit	10 / 100 Mbit	10 / 100 Mbit
IN/OUT	4 × IN, 4 × OUT for (IN – 5-24 VDC, OUT – max 30 VDC, 0,5 ADC)	4 × IN, 4 × OUT for (IN – 5-24 VDC, OUT – max 30 VDC, 0,5 ADC)	4 × IN, 4 × OUT for (IN – 5-24 VDC, OUT – max 30 VDC, 0,5 ADC)
WiFi****	802.11 b/g/n	802.11 b/g/n	802.11 b/g/n
IN12 module***	12IN / 12OUT - cable gland for (IN – 5-24 VDC, OUT – max 30 VDC, 0,5 ADC)	12IN / 12OUT - cable gland for (IN – 5-24 VDC, OUT – max 30 VDC, 0,5 ADC)	12IN / 12OUT - cable gland for (IN – 5-24 VDC, OUT – max 30 VDC, 0,5 ADC)
AN module***	4-20mA, 0-20mA current loop; 0-10V voltage loop	4-20mA, 0-20mA current loop; 0-10V voltage loop	4-20mA, 0-20mA current loop; 0-10V voltage loop
PROFIBUS module***	DP SLAVE	DP SLAVE	DP SLAVE
PROFINET Module***	1 × type RJ45	1 × type RJ45	1 × type RJ45
RS 232***	1 × hermetic connector	1 × hermetic connector	1 × hermetic connector
RS 485***	1 × cable gland	1 × cable gland	1 × cable gland
Communication protocol	ASCII Text / Modbus RTU / TCP	ASCII Text / Modbus RTU / TCP	ASCII Text / Modbus RTU / TCP
Power supply	100 ÷ 240 V AC 50 ÷ 60 Hz	100 ÷ 240 V AC 50 ÷ 60 Hz	100 ÷ 240 V AC 50 ÷ 60 Hz
Power consumption	21 W	21 W	21 W
Operating temperature	+10 ÷ +40 °C	+10 ÷ +40 °C	+10 ÷ +40 °C
Relative humidity ****	40 ÷ 80%	40 ÷ 80%	40 ÷ 80%
Transport and storage temperature	-10 ÷ +50 °C	-10 ÷ +50 °C	-10 ÷ +50 °C
Weighing pan dimensions	500 × 500 mm	500 × 500 mm	500 × 500 mm
Indicator dimensions	357 × 275 × 120 mm	357 × 275 × 120 mm	357 × 275 × 120 mm
Net weight	37 kg	37 kg	37 kg
Gross weight	52 kg	52 kg	52 kg
Platform packaging dimensions	700 × 700 × 295 mm	700 × 700 × 295 mm	700 × 700 × 295 mm
Indicator packaging dimensions	415 × 345 × 225 mm	415 × 345 × 225 mm	415 × 345 × 225 mm

* repeatability is expressed as a standard deviation from 10 weighing cycles

** under optimum ambient conditions

*** optional indicator design

**** non-condensing conditions

Wi-Fi® is a registered trademark of Wi-Fi® Alliance.

Technical Specifications

	HY10.150.HRP
Maximum capacity [Max]	150 kg
Preload	30 kg
Minimum capacity	50 g
Readability [d]	1 g
Verification unit [e]	—
Tare range	–150 kg
Repeatability *	1.5 g
Linearity	±3 g
Stabilization time **	3 s
Adjustment	internal
Verification	—
OIML class	—
Platform material	St3S powder-coated steel
Weighing pan material	AISI304 stainless steel
Indicator type	PUE HY10
Display	10.1" touch panel
Keyboard	on-screen
Ingress protection - platform	IP 66/67
Ingress protection - indicator	IP 68/69
USB	1 × type A, 1 × MR 4 PIN
RS 232	2
Ethernet	10 / 100 Mbit
IN/OUT	4 × IN, 4 × OUT for (IN – 5-24 VDC, OUT – max 30 VDC, 0,5 ADC)
WiFi®***	802.11 b/g/n
IN12 module***	12IN / 12OUT - cable gland for (IN – 5-24 VDC, OUT – max 30 VDC, 0,5 ADC)
AN module***	4-20mA, 0-20mA current loop; 0-10V voltage loop
PROFIBUS module***	DP SLAVE
PROFINET Module***	1 × type RJ45
RS 232***	1 × hermetic connector
RS 485***	1 × cable gland
Communication protocol	ASCII Text / Modbus RTU / TCP
Power supply	100 ÷ 240 V AC 50 ÷ 60 Hz
Power consumption	21 W
Operating temperature	+10 ÷ +40 °C
Relative humidity ****	40 ÷ 80%
Transport and storage temperature	–10 ÷ +50 °C
Weighing pan dimensions	800 × 600 mm
Indicator dimensions	357 × 275 × 120 mm
Net weight	71.5 kg
Gross weight	119 kg
Platform packaging dimensions	1000 × 800 × 307 mm
Indicator packaging dimensions	415 × 345 × 225 mm

* repeatability is expressed as a standard deviation from 10 weighing cycles

** under optimum ambient conditions

*** optional indicator design

**** non-condensing conditions

Technical Specifications

	HY10.150.HRP.M2.1	HY10.150.HRP.M2.2	HY10.150.HRP.M3
Maximum capacity [Max]	150 kg	150 kg	50 kg / 100 kg / 150 kg
Preload	30 kg	30 kg	30 kg
Minimum capacity	50 g	250 g	100 g / 200 g / 400 g
Readability [d]	1 g	5 g	5 g / 10 g / 20 g
Verification unit [e]	10 g	5 g	5 g / 10 g / 20 g
Tare range	-150 kg	-150 kg	-150 kg
Repeatability *	1,5 g	1,5 g	1,5 g
Linearity	±3 g	±3 g	±3 g
Stabilization time **	3 s	3 s	3 s
Adjustment	internal	internal	internal
Verification	YES	YES	YES
Maximum quantity of verification units	15000 e	30000 e	10000 e / 10000 e / 7500 e
OIML class	II	II	III
Platform material	St3S powder-coated steel	St3S powder-coated steel	St3S powder-coated steel
Weighing pan material	AISI304 stainless steel	AISI304 stainless steel	AISI304 stainless steel
Indicator type	PUE HY10	PUE HY10	PUE HY10
Display	10.1" touch panel	10.1" touch panel	10.1" touch panel
Keyboard	on-screen	on-screen	on-screen
Ingress protection - platform	IP 66/67	IP 66/67	IP 66/67
Ingress protection - indicator	IP 68/69	IP 68/69	IP 68/69
USB	1 × type A, 1 × MR 4 PIN	1 × type A, 1 × MR 4 PIN	1 × type A, 1 × MR 4 PIN
RS 232	2	2	2
Ethernet	10 / 100 Mbit	10 / 100 Mbit	10 / 100 Mbit
IN/OUT	4 × IN, 4 × OUT for (IN – 5-24 VDC, OUT – max 30 VDC, 0,5 ADC)	4 × IN, 4 × OUT for (IN – 5-24 VDC, OUT – max 30 VDC, 0,5 ADC)	4 × IN, 4 × OUT for (IN – 5-24 VDC, OUT – max 30 VDC, 0,5 ADC)
WiFi***	802.11 b/g/n	802.11 b/g/n	802.11 b/g/n
IN12 module***	12IN / 12OUT - cable gland for (IN – 5-24 VDC, OUT – max 30 VDC, 0,5 ADC)	12IN / 12OUT - cable gland for (IN – 5-24 VDC, OUT – max 30 VDC, 0,5 ADC)	12IN / 12OUT - cable gland for (IN – 5-24 VDC, OUT – max 30 VDC, 0,5 ADC)
AN module***	4-20mA, 0-20mA current loop; 0-10V voltage loop	4-20mA, 0-20mA current loop; 0-10V voltage loop	4-20mA, 0-20mA current loop; 0-10V voltage loop
PROFIBUS module***	DP SLAVE	DP SLAVE	DP SLAVE
PROFINET Module***	1 × type RJ45	1 × type RJ45	1 × type RJ45
RS 232***	1 × hermetic connector	1 × hermetic connector	1 × hermetic connector
RS 485***	1 × cable gland	1 × cable gland	1 × cable gland
Communication protocol	ASCII Text / Modbus RTU / TCP	ASCII Text / Modbus RTU / TCP	ASCII Text / Modbus RTU / TCP
Power supply	100 ÷ 240 V AC 50 ÷ 60 Hz	100 ÷ 240 V AC 50 ÷ 60 Hz	100 ÷ 240 V AC 50 ÷ 60 Hz
Power consumption	21 W	21 W	21 W
Operating temperature	+10 ÷ +40 °C	+10 ÷ +40 °C	+10 ÷ +40 °C
Relative humidity ****	40 ÷ 80%	40 ÷ 80%	40 ÷ 80%
Transport and storage temperature	-10 ÷ +50 °C	-10 ÷ +50 °C	-10 ÷ +50 °C
Weighing pan dimensions	800 × 600 mm	800 × 600 mm	800 × 600 mm
Indicator dimensions	357 × 275 × 120 mm	357 × 275 × 120 mm	357 × 275 × 120 mm
Net weight	71.5 kg	71.5 kg	71.5 kg
Gross weight	119 kg	119 kg	119 kg
Platform packaging dimensions	1000 × 800 × 307 mm	1000 × 800 × 307 mm	1000 × 800 × 307 mm
Indicator packaging dimensions	415 × 345 × 225 mm	415 × 345 × 225 mm	415 × 345 × 225 mm

* repeatability is expressed as a standard deviation from 10 weighing cycles

** under optimum ambient conditions

*** optional indicator design

**** non-condensing conditions

Wi-Fi® is a registered trademark of Wi-Fi® Alliance.

Technical Specifications

	HY10.300.HRP
Maximum capacity [Max]	300 kg
Preload	60 kg
Minimum capacity	100 g
Readability [d]	1 g
Verification unit [e]	—
Tare range	–300 kg
Repeatability *	3 g
Linearity	±6 g
Stabilization time **	3 s
Adjustment	internal
Verification	—
OIML class	—
Platform material	St3S powder-coated steel
Weighing pan material	AISI304 stainless steel
Indicator type	PUE HY10
Display	10.1" touch panel
Keyboard	on-screen
Ingress protection - platform	IP 66/67
Ingress protection - indicator	IP 68/69
USB	1 × type A, 1 × MR 4 PIN
RS 232	2
Ethernet	10 / 100 Mbit
IN/OUT	4 × IN, 4 × OUT for (IN – 5-24 VDC, OUT – max 30 VDC, 0,5 ADC)
WiFi®***	802.11 b/g/n
IN12 module***	12IN / 12OUT - cable gland for (IN – 5-24 VDC, OUT – max 30 VDC, 0,5 ADC)
AN module***	4-20mA, 0-20mA current loop; 0-10V voltage loop
PROFIBUS module***	DP SLAVE
PROFINET Module***	1 × type RJ45
RS 232***	1 × hermetic connector
RS 485***	1 × cable gland
Communication protocol	ASCII Text / Modbus RTU / TCP
Power supply	100 ÷ 240 V AC 50 ÷ 60 Hz
Power consumption	21 W
Operating temperature	+10 ÷ +40 °C
Relative humidity ****	40 ÷ 80%
Transport and storage temperature	–10 ÷ +50 °C
Weighing pan dimensions	800 × 600 mm
Indicator dimensions	357 × 275 × 120 mm
Net weight	71.5 kg
Gross weight	119 kg
Platform packaging dimensions	1000 × 800 × 307 mm
Indicator packaging dimensions	415 × 345 × 225 mm

* repeatability is expressed as a standard deviation from 10 weighing cycles

** under optimum ambient conditions

*** optional indicator design

**** non-condensing conditions

Wi-Fi® is a registered trademark of Wi-Fi® Alliance.

Technical Specifications

	HY10.300.HRP.M2.1	HY10.300.HRP .M2.2	HY10.300.HRP.M3
Maximum capacity [Max]	300 kg	300 kg	100 kg / 200 kg / 300 kg
Preload	60 kg	60 kg	60 kg
Minimum capacity	50 g	1000 g	200 g / 400 g / 1000 g
Readability [d]	1 g	20 g	10 g / 20 g / 50 g
Verification unit [e]	10 g	20 g	10 g / 20 g / 50 g
Tare range	-300 kg	-300 kg	-300 kg
Repeatability *	3 g	3 g	3 g
Linearity	±6 g	±6 g	±6 g
Stabilization time **	3 s	3 s	3 s
Adjustment	internal	internal	internal
Verification	YES	YES	YES
Maximum quantity of verification units	30000 e	15000 e	10000 g / 10000 g / 6000 e
OIML class	II	II	III
Platform material	St3S powder-coated steel	St3S powder-coated steel	St3S powder-coated steel
Weighing pan material	AISI304 stainless steel	AISI304 stainless steel	AISI304 stainless steel
Indicator type	PUE HY10	PUE HY10	PUE HY10
Display	10.1" touch panel	10.1" touch panel	10.1" touch panel
Keyboard	on-screen	on-screen	on-screen
Ingress protection - platform	IP 66/67	IP 66/67	IP 66/67
Ingress protection - indicator	IP 68/69	IP 68/69	IP 68/69
USB	1 × type A, 1 × MR 4 PIN	1 × type A, 1 × MR 4 PIN	1 × type A, 1 × MR 4 PIN
RS 232	2	2	2
Ethernet	10 / 100 Mbit	10 / 100 Mbit	10 / 100 Mbit
IN/OUT	4 × IN, 4 × OUT for (IN – 5-24 VDC, OUT – max 30 VDC, 0,5 ADC)	4 × IN, 4 × OUT for (IN – 5-24 VDC, OUT – max 30 VDC, 0,5 ADC)	4 × IN, 4 × OUT for (IN – 5-24 VDC, OUT – max 30 VDC, 0,5 ADC)
WiFi***	802.11 b/g/n	802.11 b/g/n	802.11 b/g/n
IN12 module***	12IN / 12OUT - cable gland for (IN – 5-24 VDC, OUT – max 30 VDC, 0,5 ADC)	12IN / 12OUT - cable gland for (IN – 5-24 VDC, OUT – max 30 VDC, 0,5 ADC)	12IN / 12OUT - cable gland for (IN – 5-24 VDC, OUT – max 30 VDC, 0,5 ADC)
AN module***	4-20mA, 0-20mA current loop; 0-10V voltage loop	4-20mA, 0-20mA current loop; 0-10V voltage loop	4-20mA, 0-20mA current loop; 0-10V voltage loop
PROFIBUS module***	DP SLAVE	DP SLAVE	DP SLAVE
PROFINET Module***	1 × type RJ45	1 × type RJ45	1 × type RJ45
RS 232***	1 × hermetic connector	1 × hermetic connector	1 × hermetic connector
RS 485***	1 × cable gland	1 × cable gland	1 × cable gland
Communication protocol	ASCII Text / Modbus RTU / TCP	ASCII Text / Modbus RTU / TCP	ASCII Text / Modbus RTU / TCP
Power supply	100 ÷ 240 V AC 50 ÷ 60 Hz	100 ÷ 240 V AC 50 ÷ 60 Hz	100 ÷ 240 V AC 50 ÷ 60 Hz
Power consumption	21 W	21 W	21 W
Operating temperature	+10 ÷ +40 °C	+10 ÷ +40 °C	+10 ÷ +40 °C
Relative humidity ****	40 ÷ 80%	40 ÷ 80%	40 ÷ 80%
Transport and storage temperature	-10 ÷ +50 °C	-10 ÷ +50 °C	-10 ÷ +50 °C
Weighing pan dimensions	800 × 600 mm	800 × 600 mm	800 × 600 mm
Indicator dimensions	357 × 275 × 120 mm	357 × 275 × 120 mm	357 × 275 × 120 mm
Net weight	71.5 kg	71.5 kg	71.5 kg
Gross weight	119 kg	119 kg	119 kg
Platform packaging dimensions	1000 × 800 × 307 mm	1000 × 800 × 307 mm	1000 × 800 × 307 mm
Indicator packaging dimensions	415 × 345 × 225 mm	415 × 345 × 225 mm	415 × 345 × 225 mm

* repeatability is expressed as a standard deviation from 10 weighing cycles

** under optimum ambient conditions

*** optional indicator design

**** non-condensing conditions

Wi-Fi® is a registered trademark of Wi-Fi® Alliance.

Page 13 of 22 | Date: 28.07.2020

www.radwag.com

Technical Specifications

	HY10.300.1.HRP
Maximum capacity [Max]	300 kg
Preload	60 kg
Minimum capacity	100 g
Readability [d]	1 g
Verification unit [e]	—
Tare range	–300 kg
Repeatability *	3 g
Linearity	±6 g
Stabilization time **	3 s
Adjustment	internal
Verification	—
OIML class	—
Platform material	St3S powder-coated steel
Weighing pan material	AISI304 stainless steel
Indicator type	PUE HY10
Display	10.1" touch panel
Keyboard	on-screen
Ingress protection - platform	IP 66/67
Ingress protection - indicator	IP 68/69
USB	1 × type A, 1 × MR 4 PIN
RS 232	2
Ethernet	10 / 100 Mbit
IN/OUT	4 × IN, 4 × OUT for (IN – 5-24 VDC, OUT – max 30 VDC, 0,5 ADC)
WiFi®***	802.11 b/g/n
IN12 module***	12IN / 12OUT - cable gland for (IN – 5-24 VDC, OUT – max 30 VDC, 0,5 ADC)
AN module***	4-20mA, 0-20mA current loop; 0-10V voltage loop
PROFIBUS module***	DP SLAVE
PROFINET Module**	1 × type RJ45
RS 232***	1 × hermetic connector
RS 485***	1 × cable gland
Communication protocol	ASCII Text / Modbus RTU / TCP
Power supply	100 ÷ 240 V AC 50 ÷ 60 Hz
Power consumption	21 W
Operating temperature	+10 ÷ +40 °C
Relative humidity ****	40 ÷ 80%
Transport and storage temperature	–10 ÷ +50 °C
Weighing pan dimensions	1000 × 800 mm
Indicator dimensions	357 × 275 × 120 mm
Net weight	126 kg
Gross weight	160 kg
Platform packaging dimensions	1200 × 1000 × 328 mm
Indicator packaging dimensions	415 × 345 × 225 mm

* repeatability is expressed as a standard deviation from 10 weighing cycles
 ** under optimum ambient conditions
 *** optional indicator design
 **** non-condensing conditions

Technical Specifications

	HY10.300.1.HRP.M2.1	HY10.300.1.HRP.M2.2	HY10.300.1.HRP.M3
Maximum capacity [Max]	300 kg	300 kg	100 kg / 200 kg / 300 kg
Preload	60 kg	60 kg	60 kg
Minimum capacity	50 g	1000 g	200 g / 400 g / 1000 g
Readability [d]	1 g	20 g	10 g / 20 g / 50 g
Verification unit [e]	10 g	20 g	10 g / 20 g / 50 g
Tare range	-300 kg	-300 kg	-300 kg
Repeatability *	3 g	3 g	3 g
Linearity	±6 g	±6 g	±6 g
Stabilization time **	3 s	3 s	3 s
Adjustment	internal	internal	internal
Verification	YES	YES	YES
Maximum quantity of verification units	30000 e	15000 e	10000 e / 10000 e / 6000 e
OIML class	II	II	III
Platform material	St3S powder-coated steel	St3S powder-coated steel	St3S powder-coated steel
Weighing pan material	AISI304 stainless steel	AISI304 stainless steel	AISI304 stainless steel
Indicator type	PUE HY10	PUE HY10	PUE HY10
Display	10.1" touch panel	10.1" touch panel	10.1" touch panel
Keyboard	on-screen	on-screen	on-screen
Ingress protection - platform	IP 66/67	IP 66/67	IP 66/67
Ingress protection - indicator	IP 68/69	IP 68/69	IP 68/69
USB	1 × type A, 1 × MR 4 PIN	1 × type A, 1 × MR 4 PIN	1 × type A, 1 × MR 4 PIN
RS 232	2	2	2
Ethernet	10 / 100 Mbit	10 / 100 Mbit	10 / 100 Mbit
IN/OUT	4 × IN, 4 × OUT for (IN – 5-24 VDC, OUT – max 30 VDC, 0,5 ADC)	4 × IN, 4 × OUT for (IN – 5-24 VDC, OUT – max 30 VDC, 0,5 ADC)	4 × IN, 4 × OUT for (IN – 5-24 VDC, OUT – max 30 VDC, 0,5 ADC)
WiFi***	802.11 b/g/n	802.11 b/g/n	802.11 b/g/n
IN12 module***	12IN / 12OUT - cable gland for (IN – 5-24 VDC, OUT – max 30 VDC, 0,5 ADC)	12IN / 12OUT - cable gland for (IN – 5-24 VDC, OUT – max 30 VDC, 0,5 ADC)	12IN / 12OUT - cable gland for (IN – 5-24 VDC, OUT – max 30 VDC, 0,5 ADC)
AN module***	4-20mA, 0-20mA current loop; 0-10V voltage loop	4-20mA, 0-20mA current loop; 0-10V voltage loop	4-20mA, 0-20mA current loop; 0-10V voltage loop
PROFIBUS module***	DP SLAVE	DP SLAVE	DP SLAVE
PROFINET Module**	1 × type RJ45	1 × type RJ45	1 × type RJ45
RS 232***	1 × hermetic connector	1 × hermetic connector	1 × hermetic connector
RS 485***	1 × cable gland	1 × cable gland	1 × cable gland
Communication protocol	ASCII Text / Modbus RTU / TCP	ASCII Text / Modbus RTU / TCP	ASCII Text / Modbus RTU / TCP
Power supply	100 ÷ 240 V AC 50 ÷ 60 Hz	100 ÷ 240 V AC 50 ÷ 60 Hz	100 ÷ 240 V AC 50 ÷ 60 Hz
Power consumption	21 W	21 W	21 W
Operating temperature	+10 ÷ +40 °C	+10 ÷ +40 °C	+10 ÷ +40 °C
Relative humidity ****	40 ÷ 80%	40 ÷ 80%	40 ÷ 80%
Transport and storage temperature	-10 ÷ +50 °C	-10 ÷ +50 °C	-10 ÷ +50 °C
Weighing pan dimensions	1000 × 800 mm	1000 × 800 mm	1000 × 800 mm
Indicator dimensions	357 × 275 × 120 mm	357 × 275 × 120 mm	357 × 275 × 120 mm
Net weight	126 kg	126 kg	126 kg
Gross weight	160 kg	160 kg	160 kg
Platform packaging dimensions	1200 × 1000 × 328 mm	1200 × 1000 × 328 mm	1200 × 1000 × 328 mm
Indicator packaging dimensions	415 × 345 × 225 mm	415 × 345 × 225 mm	415 × 345 × 225 mm

* repeatability is expressed as a standard deviation from 10 weighing cycles

** under optimum ambient conditions

*** optional indicator design

**** non-condensing conditions

Wi-Fi® is a registered trademark of Wi-Fi® Alliance.

Technical Specifications

	HY10.600.HRP
Maximum capacity [Max]	600 kg
Preload	60 kg
Minimum capacity	250 g
Readability [d]	5 g
Verification unit [e]	—
Tare range	–600 kg
Repeatability *	7,5 g
Linearity	±15 g
Stabilization time **	3 s
Adjustment	internal
Verification	—
OIML class	—
Platform material	St3S powder-coated steel
Weighing pan material	AISI304 stainless steel
Indicator type	PUE HY10
Display	10.1" touch panel
Keyboard	on-screen
Ingress protection - platform	IP 66/67
Ingress protection - indicator	IP 68/69
USB	1 × type A, 1 × MR 4 PIN
RS 232	2
Ethernet	10 / 100 Mbit
IN/OUT	4 × IN, 4 × OUT for (IN – 5-24 VDC, OUT – max 30 VDC, 0,5 ADC)
WiFi®***	802.11 b/g/n
IN12 module***	12IN / 12OUT - cable gland for (IN – 5-24 VDC, OUT – max 30 VDC, 0,5 ADC)
AN module***	4-20mA, 0-20mA current loop; 0-10V voltage loop
PROFIBUS module***	DP SLAVE
PROFINET Module**	1 × type RJ45
RS 232***	1 × hermetic connector
RS 485***	1 × cable gland
Communication protocol	ASCII Text / Modbus RTU / TCP
Power supply	100 ÷ 240 V AC 50 ÷ 60 Hz
Power consumption	21 W
Operating temperature	+10 ÷ +40 °C
Relative humidity ****	40 ÷ 80%
Transport and storage temperature	–10 ÷ +50 °C
Weighing pan dimensions	1000 × 800 mm
Indicator dimensions	357 × 275 × 120 mm
Net weight	126 kg
Gross weight	160 kg
Platform packaging dimensions	1200 × 1000 × 328 mm
Indicator packaging dimensions	415 × 345 × 225 mm

- * repeatability is expressed as a standard deviation from 10 weighing cycles
- ** under optimum ambient conditions
- *** optional indicator design
- **** non-condensing conditions

Technical Specifications

	HY10.600.HRP.M2.1	HY10.600.HRP.M2.2	HY10.600.HRP.M3
Maximum capacity [Max]	600 kg	600 kg	200 kg / 500 kg / 600 kg
Preload	60 kg	60 kg	60 kg
Minimum capacity	500 g	1000 g	400 g / 1000 g / 2000 g
Readability [d]	10 g	20 g	20 g / 50 g / 100 g
Verification unit [e]	100 g	20 g	20 g / 50 g / 100 g
Tare range	-600 kg	-600 kg	-600 kg
Repeatability *	7,5 g	7,5 g	7,5 g
Linearity	±15 g	±15 g	±15 g
Stabilization time **	3 s	3 s	3 s
Adjustment	internal	internal	internal
Verification	YES	YES	YES
Maximum quantity of verification units	6000 e	30000 e	10000 e / 10000 e / 6000 e
OIML class	II	II	III
Platform material	St3S powder-coated steel	St3S powder-coated steel	St3S powder-coated steel
Weighing pan material	AISI304 stainless steel	AISI304 stainless steel	AISI304 stainless steel
Indicator type	PUE HY10	PUE HY10	PUE HY10
Display	10.1" touch panel	10.1" touch panel	10.1" touch panel
Keyboard	on-screen	on-screen	on-screen
Ingress protection - platform	IP 66/67	IP 66/67	IP 66/67
Ingress protection - indicator	IP 68/69	IP 68/69	IP 68/69
USB	1 × type A, 1 × MR 4 PIN	1 × type A, 1 × MR 4 PIN	1 × type A, 1 × MR 4 PIN
RS 232	2	2	2
Ethernet	10 / 100 Mbit	10 / 100 Mbit	10 / 100 Mbit
IN/OUT	4 × IN, 4 × OUT for (IN – 5-24 VDC, OUT – max 30 VDC, 0,5 ADC)	4 × IN, 4 × OUT for (IN – 5-24 VDC, OUT – max 30 VDC, 0,5 ADC)	4 × IN, 4 × OUT for (IN – 5-24 VDC, OUT – max 30 VDC, 0,5 ADC)
WiFi***	802.11 b/g/n	802.11 b/g/n	802.11 b/g/n
IN12 module***	12IN / 12OUT - cable gland for (IN – 5-24 VDC, OUT – max 30 VDC, 0,5 ADC)	12IN / 12OUT - cable gland for (IN – 5-24 VDC, OUT – max 30 VDC, 0,5 ADC)	12IN / 12OUT - cable gland for (IN – 5-24 VDC, OUT – max 30 VDC, 0,5 ADC)
AN module***	4-20mA, 0-20mA current loop; 0-10V voltage loop	4-20mA, 0-20mA current loop; 0-10V voltage loop	4-20mA, 0-20mA current loop; 0-10V voltage loop
PROFIBUS module***	DP SLAVE	DP SLAVE	DP SLAVE
PROFINET Module**	1 × type RJ45	1 × type RJ45	1 × type RJ45
RS 232***	1 × hermetic connector	1 × hermetic connector	1 × hermetic connector
RS 485***	1 × cable gland	1 × cable gland	1 × cable gland
Communication protocol	ASCII Text / Modbus RTU / TCP	ASCII Text / Modbus RTU / TCP	ASCII Text / Modbus RTU / TCP
Power supply	100 ÷ 240 V AC 50 ÷ 60 Hz	100 ÷ 240 V AC 50 ÷ 60 Hz	100 ÷ 240 V AC 50 ÷ 60 Hz
Power consumption	21 W	21 W	21 W
Operating temperature	+10 ÷ +40 °C	+10 ÷ +40 °C	+10 ÷ +40 °C
Relative humidity ****	40 ÷ 80%	40 ÷ 80%	40 ÷ 80%
Transport and storage temperature	-10 ÷ +50 °C	-10 ÷ +50 °C	-10 ÷ +50 °C
Weighing pan dimensions	1000 × 800 mm	1000 × 800 mm	1000 × 800 mm
Indicator dimensions	357 × 275 × 120 mm	357 × 275 × 120 mm	357 × 275 × 120 mm
Net weight	126 kg	126 kg	126 kg
Gross weight	160 kg	160 kg	160 kg
Platform packaging dimensions	1200 × 1000 × 328 mm	1200 × 1000 × 328 mm	1200 × 1000 × 328 mm
Indicator packaging dimensions	415 × 345 × 225 mm	415 × 345 × 225 mm	415 × 345 × 225 mm

* repeatability is expressed as a standard deviation from 10 weighing cycles

** under optimum ambient conditions

*** optional indicator design

**** non-condensing conditions

Wi-Fi® is a registered trademark of Wi-Fi® Alliance.

Technical Specifications

	HY10.1100.HRP
Maximum capacity [Max]	1100 kg
Preload	100 kg
Minimum capacity	500 g
Readability [d]	10 g
Verification unit [e]	—
Tare range	-1100 kg
Repeatability *	15 g
Linearity	±30g
Stabilization time **	3 s
Adjustment	internal
Verification	—
OIML class	—
Platform material	St3S powder-coated steel
Weighing pan material	AISI304 stainless steel
Indicator type	PUE HY10
Display	10.1" touch panel
Keyboard	on-screen
Ingress protection - platform	IP 66/67
Ingress protection - indicator	IP 68/69
USB	1 × type A, 1 × MR 4 PIN
RS 232	2
Ethernet	10 / 100 Mbit
IN/OUT	4 × IN, 4 × OUT for (IN – 5-24 VDC, OUT – max 30 VDC, 0,5 ADC)
WiFi®***	802.11 b/g/n
IN12 module***	12IN / 12OUT - cable gland for (IN – 5-24 VDC, OUT – max 30 VDC, 0,5 ADC)
AN module***	4-20mA, 0-20mA current loop; 0-10V voltage loop
PROFIBUS module***	DP SLAVE
PROFINET Module**	1 × type RJ45
RS 232***	1 × hermetic connector
RS 485***	1 × cable gland
Communication protocol	ASCII Text / Modbus RTU / TCP
Power supply	100 ÷ 240 V AC 50 ÷ 60 Hz
Power consumption	21 W
Operating temperature	+10 ÷ +40 °C
Relative humidity ****	40 ÷ 80%
Transport and storage temperature	-10 ÷ +50 °C
Weighing pan dimensions	1000 × 800 mm
Indicator dimensions	357 × 275 × 120 mm
Net weight	126 kg
Gross weight	160 kg
Platform packaging dimensions	1200 × 1000 × 328 mm
Indicator packaging dimensions	415 × 345 × 225 mm

* repeatability is expressed as a standard deviation from 10 weighing cycles

** under optimum ambient conditions

*** optional indicator design

**** non-condensing conditions

Wi-Fi® is a registered trademark of Wi-Fi® Alliance.

Technical Specifications

	HY10.1100.HRP.M2.1	HY10.1100.HRP.M2.2	HY10.1100.HRP.M3
Maximum capacity [Max]	1100 kg	1100 kg	200 kg / 500 kg / 1000 kg
Preload	100 kg	100 kg	100 kg
Minimum capacity	500 g	2500 g	400 g / 1000 g / 2000 g
Readability [d]	10 g	50 g	20 g / 50 g / 100 g
Verification unit [e]	100 g	50 g	20 g / 50 g / 100 g
Tare range	-1100 kg	-1100 kg	-1000 kg
Repeatability *	15 g	15 g	15 g
Linearity	±30g	±30g	±30 g
Stabilization time **	3 s	3 s	3 s
Adjustment	internal	internal	internal
Verification	YES	YES	YES
Maximum quantity of verification units	11000 e	22000 e	10000 e / 10000 e / 10000 e
OIML class	II	II	III
Platform material	St3S powder-coated steel	St3S powder-coated steel	St3S powder-coated steel
Weighing pan material	AISI304 stainless steel	AISI304 stainless steel	AISI304 stainless steel
Indicator type	PUE HY10	PUE HY10	PUE HY10
Display	10.1" touch panel	10.1" touch panel	10.1" touch panel
Keyboard	on-screen	on-screen	on-screen
Ingress protection - platform	IP 66/67	IP 66/67	IP 66/67
Ingress protection - indicator	IP 68/69	IP 68/69	IP 68/69
USB	1 × type A, 1 × MR 4 PIN	1 × type A, 1 × MR 4 PIN	1 × type A, 1 × MR 4 PIN
RS 232	2	2	2
Ethernet	10 / 100 Mbit	10 / 100 Mbit	10 / 100 Mbit
IN/OUT	4 × IN, 4 × OUT for (IN – 5-24 VDC, OUT – max 30 VDC, 0,5 ADC)	4 × IN, 4 × OUT for (IN – 5-24 VDC, OUT – max 30 VDC, 0,5 ADC)	4 × IN, 4 × OUT for (IN – 5-24 VDC, OUT – max 30 VDC, 0,5 ADC)
WiFi***	802.11 b/g/n	802.11 b/g/n	802.11 b/g/n
IN12 module***	12IN / 12OUT - cable gland for (IN – 5-24 VDC, OUT – max 30 VDC, 0,5 ADC)	12IN / 12OUT - cable gland for (IN – 5-24 VDC, OUT – max 30 VDC, 0,5 ADC)	12IN / 12OUT - cable gland for (IN – 5-24 VDC, OUT – max 30 VDC, 0,5 ADC)
AN module***	4-20mA, 0-20mA current loop; 0-10V voltage loop	4-20mA, 0-20mA current loop; 0-10V voltage loop	4-20mA, 0-20mA current loop; 0-10V voltage loop
PROFIBUS module***	DP SLAVE	DP SLAVE	DP SLAVE
PROFINET Module**	1 × type RJ45	1 × type RJ45	1 × type RJ45
RS 232***	1 × hermetic connector	1 × hermetic connector	1 × hermetic connector
RS 485***	1 × cable gland	1 × cable gland	1 × cable gland
Communication protocol	ASCII Text / Modbus RTU / TCP	ASCII Text / Modbus RTU / TCP	ASCII Text / Modbus RTU / TCP
Power supply	100 ÷ 240 V AC 50 ÷ 60 Hz	100 ÷ 240 V AC 50 ÷ 60 Hz	100 ÷ 240 V AC 50 ÷ 60 Hz
Power consumption	21 W	21 W	21 W
Operating temperature	+10 ÷ +40 °C	+10 ÷ +40 °C	+10 ÷ +40 °C
Relative humidity ****	40 ÷ 80%	40 ÷ 80%	40 ÷ 80%
Transport and storage temperature	-10 ÷ +50 °C	-10 ÷ +50 °C	-10 ÷ +50 °C
Weighing pan dimensions	1000 × 800 mm	1000 × 800 mm	1000 × 800 mm
Indicator dimensions	357 × 275 × 120 mm	357 × 275 × 120 mm	357 × 275 × 120 mm
Net weight	126 kg	126 kg	126 kg
Gross weight	160 kg	160 kg	160 kg
Platform packaging dimensions	1200 × 1000 × 328 mm	1200 × 1000 × 328 mm	1200 × 1000 × 328 mm
Indicator packaging dimensions	415 × 345 × 225 mm	415 × 345 × 225 mm	415 × 345 × 225 mm

* repeatability is expressed as a standard deviation from 10 weighing cycles

** under optimum ambient conditions

*** optional indicator design

**** non-condensing conditions

Wi-Fi® is a registered trademark of Wi-Fi® Alliance.

Page 19 of 22 | Date: 28.07.2020

www.radwag.com

Technical Specifications

	HY10.2000.HRP
Maximum capacity [Max]	2000 kg
Preload	200 kg
Minimum capacity	1000 g
Readability [d]	20 g
Verification unit [e]	—
Tare range	–2000 kg
Repeatability *	30 g
Linearity	±60g
Stabilization time **	3 s
Adjustment	internal
Verification	—
OIML class	—
Platform material	St3S powder-coated steel
Weighing pan material	AISI304 stainless steel
Indicator type	PUE HY10
Display	10.1" touch panel
Keyboard	on-screen
Ingress protection - platform	IP 66/67
Ingress protection - indicator	IP 68/69
USB	1 × type A, 1 × MR 4 PIN
RS 232	2
Ethernet	10 / 100 Mbit
IN/OUT	4 × IN, 4 × OUT for (IN – 5-24 VDC, OUT – max 30 VDC, 0,5 ADC)
WiFi®***	802.11 b/g/n
IN12 module***	12IN / 12OUT - cable gland for (IN – 5-24 VDC, OUT – max 30 VDC, 0,5 ADC)
AN module***	4-20mA, 0-20mA current loop; 0-10V voltage loop
PROFIBUS module***	DP SLAVE
PROFINET Module**	1 × type RJ45
RS 232***	1 × hermetic connector
RS 485***	1 × cable gland
Communication protocol	ASCII Text / Modbus RTU / TCP
Power supply	100 ÷ 240 V AC 50 ÷ 60 Hz
Power consumption	21 W
Operating temperature	+10 ÷ +40 °C
Relative humidity ****	40 ÷ 80%
Transport and storage temperature	–10 ÷ +50 °C
Weighing pan dimensions	1250 × 1000 mm
Indicator dimensions	357 × 275 × 120 mm
Net weight	300 kg
Gross weight	425 kg
Platform packaging dimensions	1500 × 1250 × 615 mm
Indicator packaging dimensions	415 × 345 × 225 mm

- * repeatability is expressed as a standard deviation from 10 weighing cycles
- ** under optimum ambient conditions
- *** optional indicator design
- **** non-condensing conditions

Dimensions

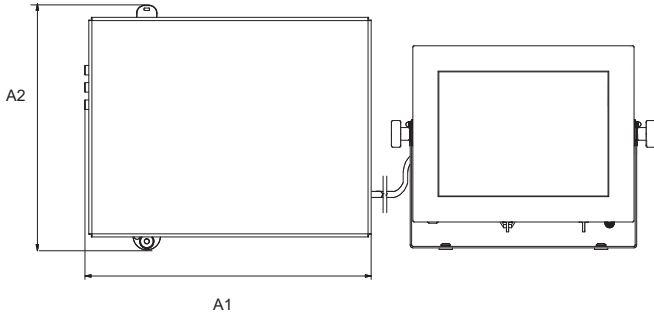
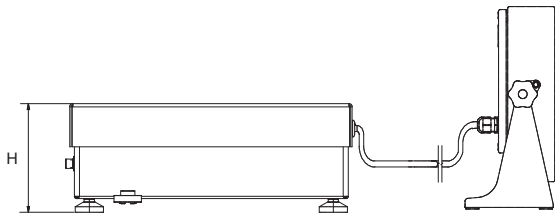

HY10.16 - 32.HRP

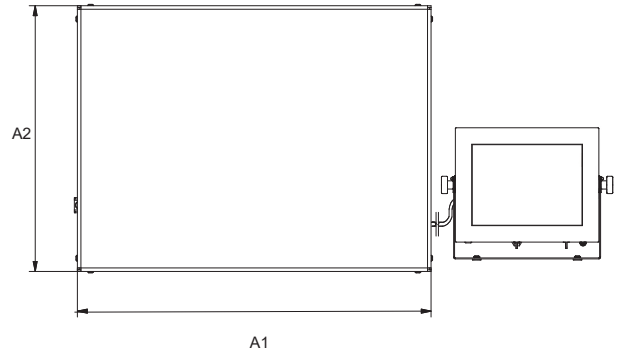
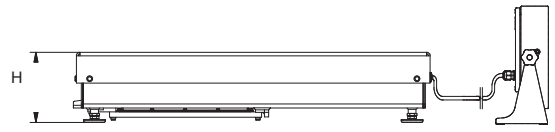

HY10.HRP

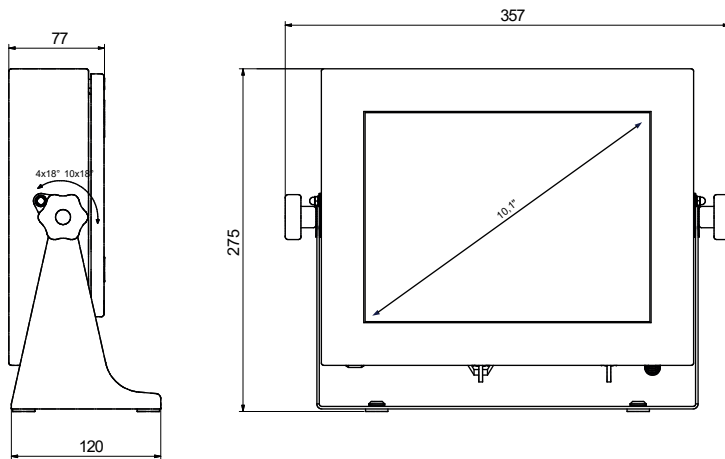

PUE HY10

Scale type	A1	A2	H
HY10.62 -120.HRP	500	500	150±3
HY10.150 - 300.HRP	800	600	175±3
HY10.300.1 -1100.HRP	1000	800	175±3
HY10.2000.HRP	1250	1000	175±3
HY10.16 -32.HRP	360	280	139±3

dimensions in mm

Accessories

Peripheral Devices

- Epson dot matrix printer
- Zebra labellers
- WWG-2/4 large-size display
- LCD – WD-4/3 display (backlit)
- stack light
- control buttons
- transponder card scanner
- barcode scanner

Cables, Converters

- PT0019 cable – (scale – Epson printer)
- USB – PT0087 cable (Epson printer)
- PT0022 – cable (scale - Zebra printer)
- PT0020 cable – (scale– computer)
- RS-232 – PT0326 cable (indicator– indicator)

- RS 232 – PT0348 cable (scale–HRP, MWSH, MWLH)
- Ethernet 0198 cable
- IN/OUT– PT0256 cable
- USB type A-B cable
- Ethernet cable

Weighing Platforms

- 1 load cell platforms
- 4 load cell platforms
- high resolution platforms

Remaining Accessories

- stands for indicators
- weighing tables

Dedicated Software

R-LAB

- collecting measurements
- carrying out statistical analysis of measurements
- customized graphs and reports

Label Editor R02

- designing label templates
- sending graphics and fonts to label printers
- printing label templates using connected printers

E2R PGC

- synchronization of databases, operators, products schedules
- record of measurements and PGC controls carried out on weighing instruments linked in ETHERNET network
- quality assessment of pre- packaged goods based on acquired data

E2R Weighing Records

- complete, automated databases synchronization
- fully supported processes of labelling and parts counting
- record of weighings, weighings archiving
- basic and advanced (with graphs) reports

E2R Formulations

- carrying out simple formulations
- support of an advanced formulations orders function
- warehouse management
- optional automatic dispensing and constant correction of the dispensing process
- control of an ingredient using the barcode scanner

E2R Weighings

- record of measurements carried out using the weighing indicators
- online monitoring of the production lines
- weighing thresholds control
- employees working time reporting

RAD KEY

- Establishing cooperation between a weighing instrument and a computer

R.Barcode

- The basic function software is presentation of the data sent by barcode scanners connected to PC via USB or RS232

Radwag Development Studio

- presentation of functions (and subfunctions) of communication protocol (Common Communication Protocol)

- possibility of connection with weighing equipment on which each function is carried out,
- library with mass control, contained within the development environment
- complete documentation of the communication protocol
- set of user manuals for different solutions addressed for programmers employed in companies using RADWAG-manufactured weighing equipment

RADWAG Connect

- establishing communication with all balances, scales and weighing modules using Common Communication Protocol
- communication via local network,
- support of basic functions
- auto searching for devices
- connecting with few devices simultaneously, swapping between them
- clear list of connected platforms
- record of measurements in the program,
- export of carried out measurements to CSV file,
- work performed using freely selected device with Windows 10

LabView Driver

- operation of RADWAG balances in LabView environment

RADWAG Remote Desktop

- remote operation via computer, mobile phone or tablet
- sending text messages
- version for Windows 10 and Android systems

Parameters Editor

- remote change of parameters
- remote on-line preview of the display
- displaying current mass indication
- software update
- file loading, editing and saving parameters to a file
- import and export of parameters
- interfaces: RS232, Ethernet and WiFi®.
- quick and easy edition of balance parameters using computer.

Audit Trail Reader

- support of Audit Trail function available for 3Y, 4Y, HY10, WLY, WPY series weighing instruments
- record of operator's activity from the moment of logging in