

FG series

INSTRUCTION MANUAL

Digital Platform Scales

FG-150KAL	FG-150KAM	FG-150KBM
FG-60KAL	FG-60KAM	FG-60KBM
	FG-30KAM	FG-30KBM



A&D

A&D Company, Limited

WM+PD4000966

This manual and Marks

All safety messages are identified by the following, "WARNING" or "CAUTION", of ANSI Z535.4 (American National Standard Institute: Product Safety Signs and Labels). The meanings are as follows:

 WARNING	A potentially hazardous situation which, if not avoided, could result in death or serious injury.
 CAUTION	A potentially hazardous situation which, if not avoided, may result in minor or moderate injury.



This is a hazard alert mark.



This mark informs you about the operation of the product.

- This manual is subject to change without notice at any time to improve the product.
- Product specifications are subject to change without any obligation on the part of the manufacturer.

Contents

1. INTRODUCTION	2
2. UNPACKING	2
3. NAMES AND FUNCTIONS	3
4. SETTING UP	6
4-1. Attaching a display pod to the base (FG-KAL and FG-KAM)	6
4-2. Installing the scale	6
4-3. Power source	7
5. BASIC OPERATION	8
5-1. Turning the power ON and OFF	8
5-2. Selecting a weighing unit	8
5-3. Basic operation	8
5-4. Weight display resolution	9
6. COUNTING MODE	10
7. COMPARATOR	11
8. CALIBRATION	12
8-1. Calibration using a weight	12
8-2. Gravity acceleration correction	13
9. FUNCTIONS	14
9-1. The procedure for setting parameters	14
9-2. Function list	15
10. OPTIONS	16
10-1. Installation of OP-23/OP-24	16
10-2. OP-23 RS-232C serial interface	17
10-3. OP-24 RS-232C serial interface and Comparator relay output	20
11. MAINTENANCE	21
11-1. Notes on maintenance	21
11-2. Error codes	21
12. SPECIFICATIONS	22
12-1. Specifications	22
12-2. Dimensions	23
GRAVITY ACCELERATION MAP	24

1. INTRODUCTION

This manual describes how this scale works and how to get the most out of it in terms of performance.

FG series platform scales have the following features:

- The FG series has three kinds of weight display resolution, 1/3,000, 1/6,000 (1/7,500) and 1/12,000 (1/15,000).
- There are 2 sizes of weighing pan. The FG-KAL has a larger pan and the FG-KAM/KBM has a smaller pan. The FG-KAL/KAM has a display column and the FG-KBM is a without column model. You can select a model that suits your own application.
- As power source, you can use an AC adapter or C size dry batteries.
- The counting function easily counts the number of articles of the same weight.
- The comparator function compares the display value with upper limit and lower limit. The display shows the result and the optional FG-24 can output it as a relay signal.
- The optional FG-23 and FG-24 has an RS-232C interface and can output the weighing data to connect with a printer, computer and so on.

2. UNPACKING

When unpacking, check whether all of the following items are included:

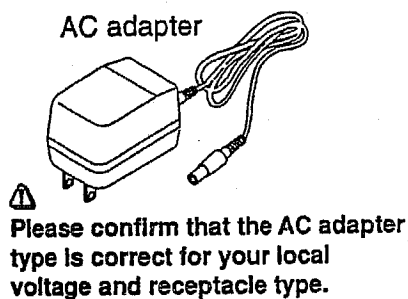
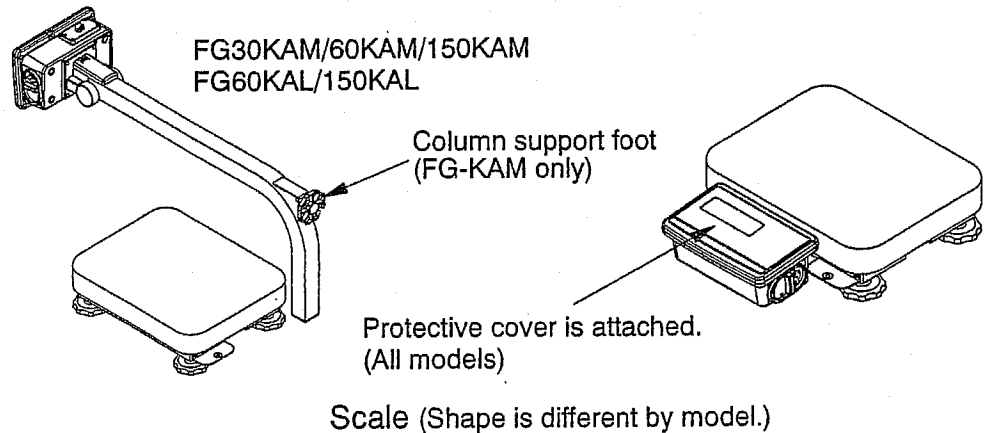

Instruction manual

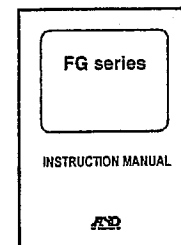

3. NAMES AND FUNCTIONS

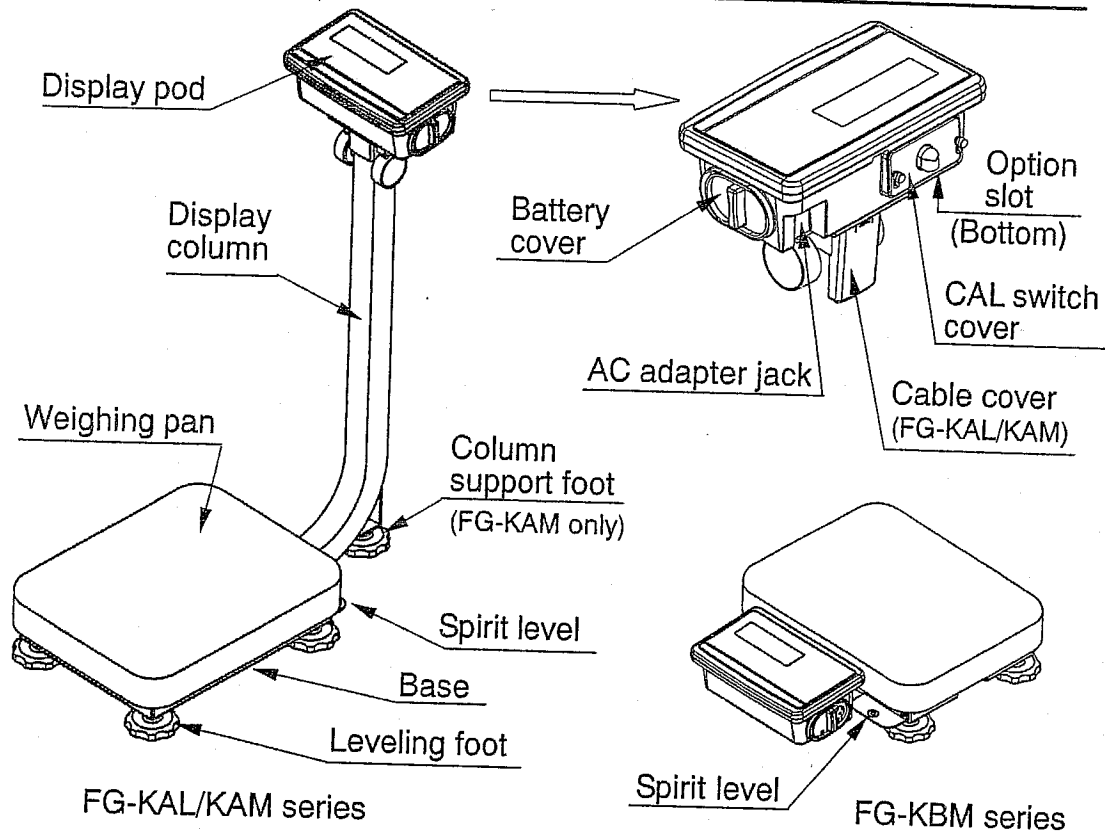

Metric models

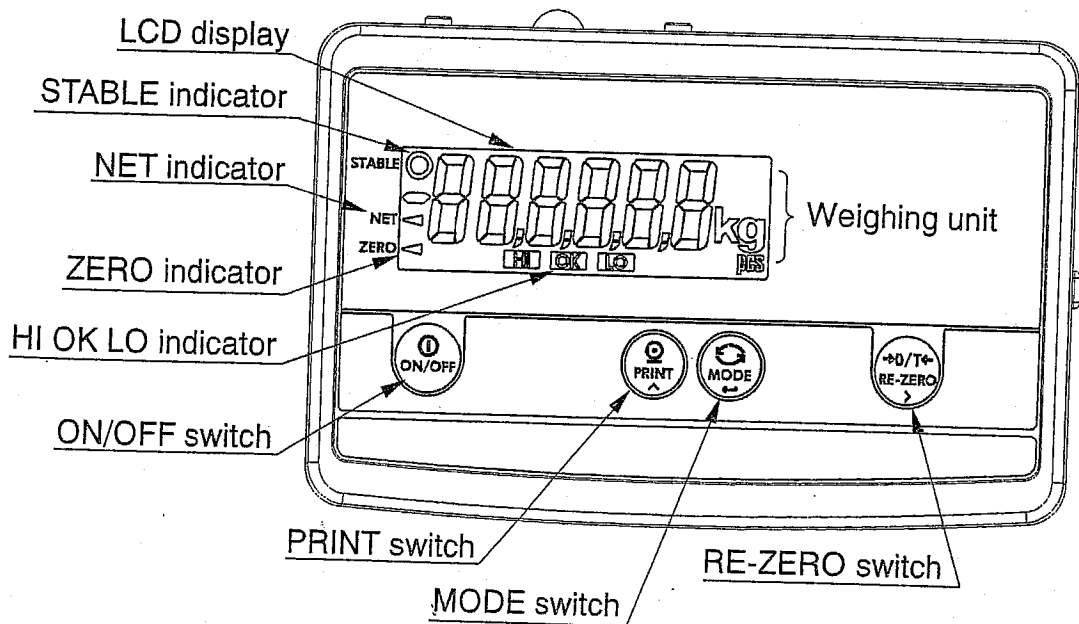

U.S.A. models

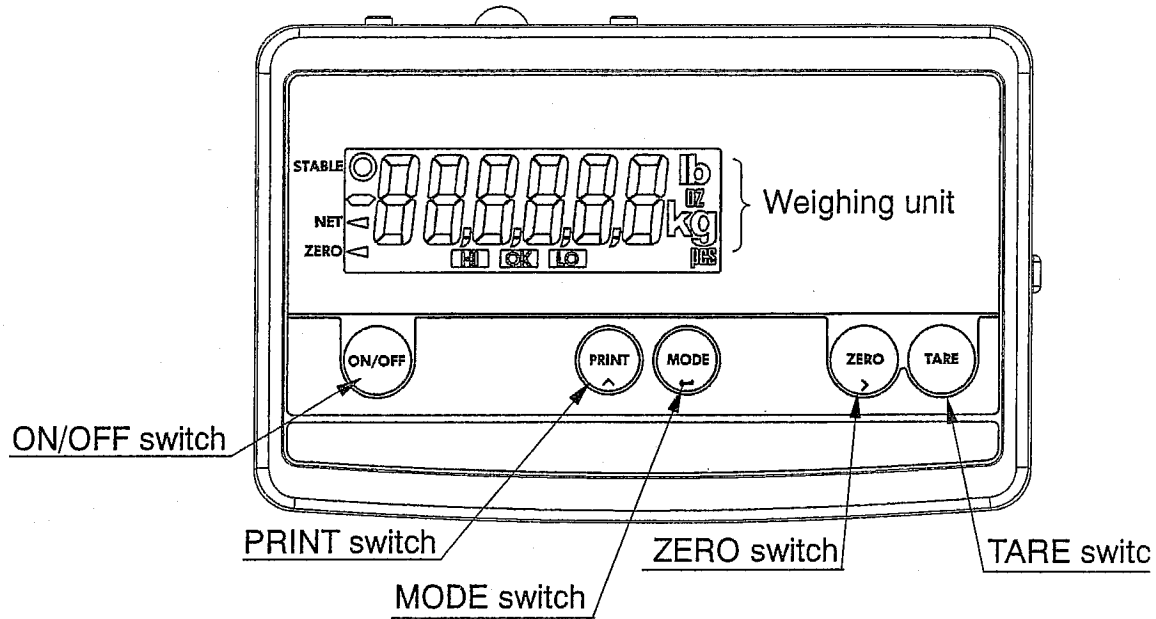

Indicators

- STABLE O Indicates when the reading is stable.
- NET ◀ Indicates when NET weight is displayed. (Tare function is used.)
- ZERO ◀ Indicates when the scale zero is correct.
- HI OK LO Indicates when the scale zero is correct.
- Weighing units "kg" and "pcs" for metric models
"lb", "oz", "kg" and "pcs" for U.S.A. models

Switches



ON/OFF Switch

Used to turn the power on or off. When turned on, the scale will be automatically set to zero (power-on zero).

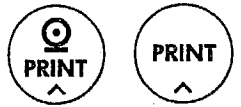

PRINT Switch

Outputs the weight value to printer. In the setting mode, this switch is used to increment the value of the selected digit blinking.

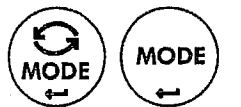

MODE Switch

Switches the weighing unit. In the setting mode, this switch is used to store a parameter and go to the next.



RE-ZERO Switch

Clears the display to zero. In the setting mode, this switch is used to select a digit blinking to change its value.



ZERO Switch U.S.A. model

Zeroes the scale and turns the display zero. In the setting mode, this switch is used to select a digit blinking to change its value.



TARE Switch U.S.A. model

Subtracts tare (container) weight on the weighing pan.

- The **RE-ZERO**, **ZERO** and **TARE** switches work when the weight value is stable.
- The **RE-ZERO** and **ZERO** switches will zero the scale if the weight is within $\pm 2\%$ of the weighing capacity (kg) around the power-on zero point. The ZERO indicator ? turns on.
- If the weight exceeds $+2\%$ of the weighing capacity (kg), the **RE-ZERO** switch will tare the scale. In this case the ZERO and NET indicators turn on.
- The **TARE** switch will tare the scale when the weight is plus value. In this case the ZERO and NET indicators turn on.
- The ZERO operation clears tare operation previously done and NET indicator turns off.

4. SETTING UP

4-1. Attaching a display pod to the base (FG-KAL and FG-KAM)

1. First, remove the 4 screws from the bottom of the display column.

2. Set the display column to the base by pulling the cable into the base.

Take care not to pinch the cable between the column and the base.

3. Tighten the 4 screws removed at step 1 to fix the display column firmly.

4. Tilt the display pod forward by pressing in on the two round side clamps, and slide off the cable cover.

5. Pull the bundle of cable out from the top end of display column, feeding all of slack of the cable on the base into the display column.

Take care not to scratch the cable.

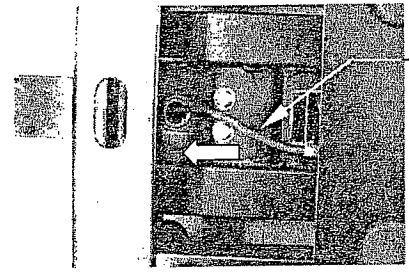
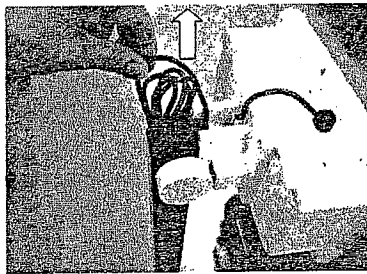
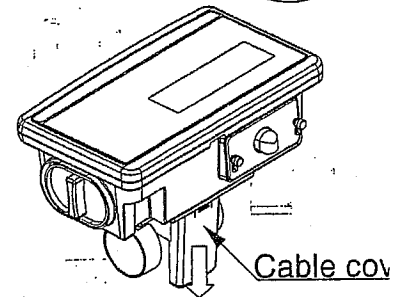
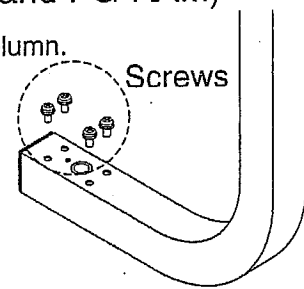

Cable
Neither slack
Nor tension

6. Put the bundle of cable back into the display column.

7. Make sure the cable is fitted to the 2 cable guides and attach the cable cover.

8. Place the weighing pan on the base.

Cable guide

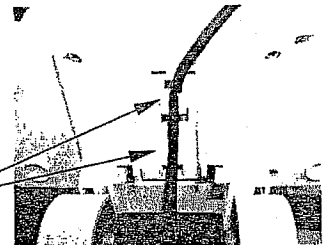

4-2. Installing the scale

1. Select the place for installing the scale. Refer to "Cautions for installing the scale" below.

2. Adjust the level of the base, using the spirit level and leveling feet. The FG-KAM has an extra foot under the display column. Adjust this foot to reach floor after adjusting the level of the base.

3. Tilt the display pod by pressing in on the two round side clamps.

Cautions for installing the scale

Consider the following conditions to get the most out of your scale.

- Install the scale where the temperature and relative humidity is stable. There is no draft and a stable power source is available.
- Install the scale on a solid and level surface.
- Do not install the scale in direct sunlight.
- Do not install the scale near heaters or air conditioners.
- Do not install the scale where there is flammable or corrosive gas present.
- Do not install the scale near equipment which produces magnetic fields.
- Do not install the scale where there is apt to be static electricity, in a place where the relative humidity is lower than 45% RH. Plastic and isolators are apt to be charged with static electricity.
- Do not use an unstable power source.
- When the scale is installed for the first time, or the scale has been moved, carry out calibration as described in "8. CALIBRATION".

4-3. Power source

For the power source, the AC adapter or C size dry cells can be used.

When using the AC adapter

Use a stable power source. To use the AC adapter, insert the AC adapter plug into the AC adapter jack on the rear side of display pod.

- Confirm the AC adapter type is correct for your local voltage.**

When using the batteries

Prepare 4 x C size (R14P/LR14) dry batteries. The batteries are not included in the product. The scale can be used continuously for about 150 hours using the alkaline batteries.

1. Turn of the scale and disconnect the AC adapter if used.
2. Slide the battery cover off
3. Push the battery case inside the display pod and take it out.
4. Insert four new dry cells into the battery case.
5. Push the battery case into the display pod as before.
6. Attach the battery cover.

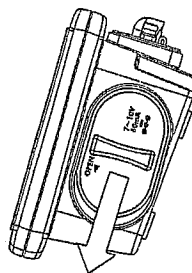

- Take great care of the polarity of batteries. The polarity marks are shown in the battery case.**
- Replace used batteries with four new ones when "LB" is displayed.**
- Do not mix used and new batteries. It may cause damage to the battery or product, if used.**
- Do not mix the battery type. It may cause damage to the battery or product.**
- The battery life depends on the ambient temperature.**
- Remove batteries from display pod when the scale is not to be used for a long time. They may leak and cause damage.**
- Damage due to battery leakage is not covered by the warranty.**

6. Remove the object from the weighing pan.

- The **RE-ZERO** switch will zero the scale if the weight is within $\pm 2\%$ of the weighing capacity (kg) around the power-on zero point. The ZERO indicator ? turns on. When the weight exceeds $+2\%$ of the weighing capacity (kg), it will be subtracted to zero as a tare weight. In this case the ZERO and NET indicators turn on.
- The **ZERO** switch will zero the scale if the weight is within $\pm 2\%$ of the weighing capacity (kg) around the power-on zero point. The ZERO indicator ? turns on. When the weight exceeds $\pm 2\%$ of the weighing capacity (kg), the switch does not work.
- The **TARE** switch will subtract the weight to zero as a tare weight when the weight is a plus value.

Precautions during operation

- Make sure that the **STABLE** indicator is on whenever reading or storing a value.
- Do not press switches with a sharp implement such as a pencil.
- Do not apply a shock load to the scale.
- Do not place a load onto the pan that exceeds the capacity.
- Keep the scale free from foreign objects such as dust or liquid.
- Calibrate the scale periodically to keep weighing accuracy.
(See "8. CALIBRATION".)

5-4. Weight display resolution

The FG series has three kinds of weight display resolution, NORMAL, HIGH and HIGHER. The following is about "kg" and "lb" display for reference. See the "12. SPECIFICATIONS" in detail.

NORMAL:	1/3,000
HIGH:	1/6,000 ~ 1/7,500 (depending on capacity)
HIGHER:	1/12,000 ~ 1/15,000 (depending on capacity)

The factory setting is the HIGH resolution, but it is possible to change by Function settings "F2". Set this function according to the application.

- In some countries, the resolution will be limited NORMAL only, and the setting F2 is not available.
- In the COUNTING mode, the scale works as in the HIGHER resolution regardless of weight display resolution.

6. COUNTING MODE

Determines a unit weight (the weight of one piece) from sample pieces, and calculates how many pieces on the weighing pan using the unit weight.

1. Press the **MODE** switch to select "pcs".
("pcs" = pieces)

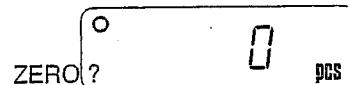

2. Press and hold the **MODE** switch to enter the sample unit weight storing mode.

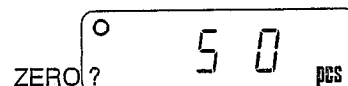

3. To select the number of samples, press the **PRINT** switch. It may be set to 5, 10, 20, 50 or 100.

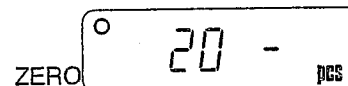

Confirm the display

4. If necessary, place a container on the weighing pan, and press the **RE-ZERO** (**TARE**) switch. Confirm that the right side of the number of samples shows zero.

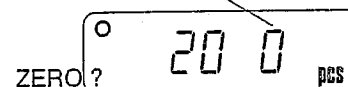

5. Place the correct number of samples on the pan or in the container.

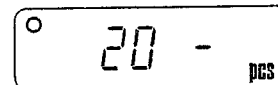

6. Press the **MODE** switch to calculate and store the unit weight. Remove the sample. The scale is set to count objects with this unit weight.

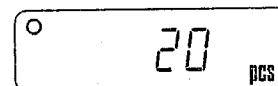

- The total weight of sample pieces should be more than below regardless of number of sample pieces.

FG-30K: 25 g
FG-60K: 62.5 g
FG-150K: 125 g

If not, the display shows "Lo Ut" and returns to the previous display. Increase the number of samples (go to step 3) and try again.

- If pressing the **MODE** switch without adding sample pieces or adding enough weight to be acceptable as a unit weight, the display leaves counting mode and switches to the next weight unit.

7. Place the objects to be counted on the pan.

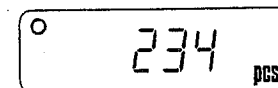

- Unit weigh is maintained even if the scale is powered off.

7. COMPARATOR

The results of the comparison are indicated by HI, OK or LO on the display.

The formula to compare is as follows:

$$LO < \text{Lower limit value} = OK = \text{Upper limit value} < HI$$

Operating conditions (see the "Function list F6"):

F6-0: No comparison (comparator function disabled).

F6-1: To compare all data.

F6-2: To compare more than +4d or less than -4d.

F6-3: To compare all stable data.

F6-4: To compare stable data more than +4d or less than -4d.

F6-5: To compare stable data more than +4d.

d = minimum weight display (see "12-1 Specifications")

In case of counting mode, "d" is equal to minimum weight display of kg mode.

- The upper limit and lower limit numerical values are common to each of the weighing and counting mode.
- Ignore the decimal point of setting value to apply it to each mode.
Example of FG30K / setting value is "001000".

Display mode	Limit value	Display capacity
NORMAL resolution kg	10.00 kg	30.00 kg x 0.01 kg
HIGH resolution kg	1.000 kg	30.000 kg x 0.005 kg
HIGHER resolution kg	1.000 kg	30.000 kg x 0.002 kg
NORMAL resolution lb	10.00 lb	60.00 kg x 0.02 lb
HIGH resolution lb	10.00 lb	60.00 kg x 0.01 lb
HIGHER resolution lb	1.000 lb	60.000 kg x 0.005 lb
Counting mode	1000 pcs	

Entering the upper and lower limit values

- Press the **MODE** switch to select weighing unit "kg", "lb" or "oz"

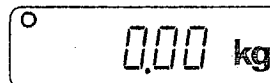

- Press and hold the **MODE** switch to enter the upper limit setting mode.



- Enter an upper limit value using the following switches.

RE-ZERO or **ZERO** To select the digit blinking to change.

PRINT Increment the value of the selected digit.

The minus sign can be set at the next digit of the least significant digit. The **PRINT** switch alternates the minus sign on and off. The blinking "-" shows minus and no sign is plus.



- After setting all of digits, press the **MODE** switch. Then, the upper limit is stored and the display goes to the lower setting mode.

- Set the lower limit in a similar way, and press the **MODE** switch to return to weighing mode.

- The upper and lower limits are maintained even if the scale is powered off.

8. CALIBRATION

This function adjusts the scale for accurate weighing.
Calibrate the scale in the following cases.

- When the scale is first used.
- When the scale has been moved.
- When the ambient environment has changed.
- For regular calibration.

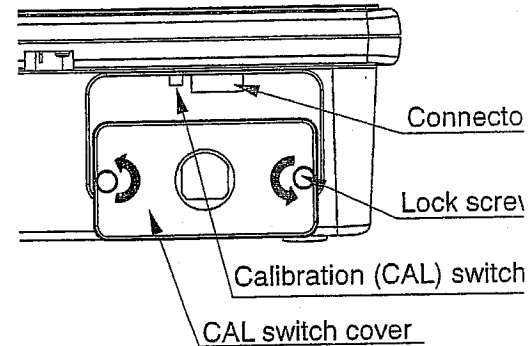

Loosen the lock screws on the rear side of the display pod, and remove the CAL switch cover. Then, there is a calibration switch on the board inside.

- For the FG-KB series (without column), you may once remove the weighing pan to access lock screws easily.

⚠ **Do not use a ballpoint pen and so on to press the calibration switch. That may short-circuit and damage the scale.**

8-1. Calibration using a weight

1. Warm up the scale for at least half an hour with nothing on the weighing pan.

- Change Function setting "F1" or place something on the pan to disable the auto power-off function.

2. Press and hold the calibration (CAL) switch until CAL 0 appears, and release the switch.

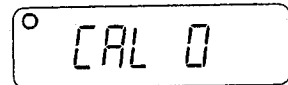

- The weighing unit must be "kg" or "lb" to enter calibration mode.**

3. Make sure that there is nothing on the weighing pan, and wait until the STABLE indicator turns on.

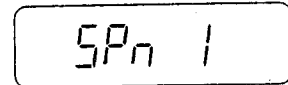

4. Press the MODE switch. The scale calibrates the zero point, and the display shows "SPn 1" and the weight value to calibrate (SPAN calibration).

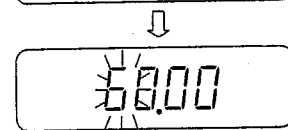

- The weight value is equal to the capacity. When you enter with "kg" mode, then the value is "kg". Entering with "lb", then "lb".**

If you do not need SPAN calibration, turn the power off to exit from the calibration procedure.

5. To calibrate with the different weight, change the displayed value using the following switches.

RE-ZERO or ZERO

To select the digit blinking to change.

PRINT

Increment the value of the selected digit.

6. Place the calibration weight on the pan with the same value as displayed, and wait until the STABLE indicator turns on.

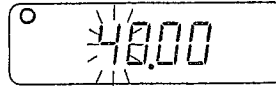

7. Press the **MODE** switch. The scale calibrate SPAN and **End** will appear.

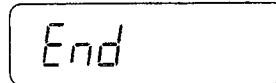

Remove the weight from the pan, and turns the power off.

Note

The value set in step 5 is cleared after the power is switched off.

If the scale will suppose to move to another location, set the gravity acceleration value for the current location and calibrate the scale according to the procedure above. See the next section to set the value.

8-2. Gravity acceleration correction

When the scale is first used or has been moved to different place, it should be calibrated using a calibration weight.

But if a calibration weight is not available, the gravity acceleration correction will compensate the scale. Change the gravity acceleration value of the scale to the value of area where the scale will be used. Refer to the gravity acceleration map appended to the end of this manual.

Note

It is not necessary to set the gravity acceleration correction when calibrating the scale with a calibration weight at the place where it is to be used.

1. Press and hold the calibration (CAL) switch until **CAL 0** appears, and release the switch.

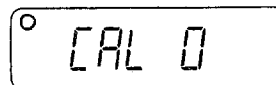

The weighing unit must be "kg" or "lb" to enter calibration mode.

2. Press the **PRINT** switch.
The display shows the gravity acceleration value memorized in the scale.

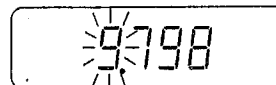

3. To change the displayed value using the following switches.

RE-ZERO or **ZERO** To select the digit blinking to change.

PRINT Increment the value of the selected digit.

4. Press the **MODE** switch. The display returns to **CAL 0**.

5. If necessary to calibrate the scale using a calibration weight, go to step 3 of "8-1. Calibration using a weight". To finish the setting, turn the power off.

9. FUNCTIONS

The scale has Function settings to expand your applications. The parameters set in the Function settings are maintained even if the power switcher off.

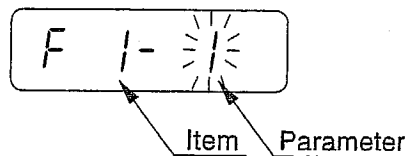

9-1. The procedure for setting parameters

1. Turn the power off.
2. Press and hold the **ZERO** switch and turn the power on via the **ON/OFF** switch. Then, the first function item and its parameter is displayed.
3. Set the parameter value using the **PRINT** switch.
 - If you do not need to change the parameter, go to next step without setting.
4. Press the **MODE** switch. Then the display goes to the next function item.
 - In this stage, the new parameter is not stored in the scale yet.*
 - To end changing the parameters, turn the power off.*
5. Repeat the steps 3 and 4 to the last item.
6. After setting the last item, press the **MODE** switch, Then, **End** will appear.
7. Press the **MODE** switch again. The parameters are stored in the scale, and the scale will automatically boot up.
 - If you turn the power off before this step is done, none of the parameters will be changed.*

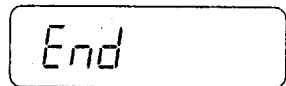
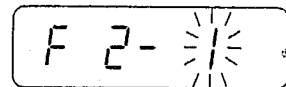
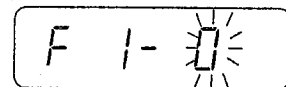
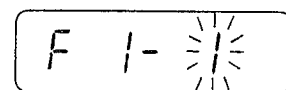

9-2. Function list

Item	Description		
Auto power-off function	F 1- 0	Auto power-off disabled	Automatically power off
	♦ F 1- 1	Auto power-off enabled for battery use only	
	F 1- 2	Auto power-off enabled for battery and AC adapter	
Display resolution	F 2- 0	Normal (1/3,000 class)	Legal for trade will be Normal.
	♦ F 2- 1	High (1/6,000~1/7,500 class)	
	F 2- 2	Higher (1/12,000~1/15,000 class)	
Weighing unit when powered on	♦ F 3- 0	lb	U.S.A. models only
	F 3- 1	oz	
	F 3- 2	kg	
RS-232C Baud rate	♦ F 4- 0	2400 bps	
	F 4- 1	4800 bps	
	F 4- 2	9600 bps	
RS-232C Data output mode	♦ F 5- 0	Stream mode	
	F 5- 1	Command mode	
	F 5- 2	Print switch mode	
	F 5- 3	Auto-print mode +/- data	
	F 5- 4	Auto-print mode + data	
Comparator mode	♦ F 6- 0	Comparator disabled	Conditions to compare. d = minimum display division
	F 6- 1	Compares all data	
	F 6- 2	Compares data > +4d or < -4d	
	F 6- 3	Compares all stable data	
	F 6- 4	Compares stable data > +4d or < -4d	
Filtering to weighing data	F 7- 0	Weak / fast response	
	♦ F 7- 1	Normal / normal response	
	F 7- 2	Strong / slow response	
RS-232C Data format	♦ F 8- 0	Reply is sent	Reaction to the command
	F 8- 1	No reply except "Q" command	

♦ Factory setting

10. OPTIONS

The following options are available for the FG series:

- OP-23 (FG-23) RS-232C serial interface
- OP-24 (FG-24) RS-232C serial interface and Comparator relay output
- OP-23 and OP-24 cannot be used together.**

10-1. Installation of OP-23/OP-24

The OP-23/OP-24 has an interface board, an option panel and a DIN 8 pin connector. The option panel and DIN connector are common to both options. Before installation, prepare an interface cable using attached DIN connector. Or there is a way to use the optional RS-232C cable (see "10-2. OP-23 RS-232C serial interface").

1. Disconnect the AC adapter from the scale.
2. Remove the four screws and the cover of option slot.
3. Thread the interface cable through the hole of option panel first, and connect the DIN connector to the interface board.
4. Connect the interface board to the connector in the display pod.
5. Attach and fix the option panel using the screws that removed in the step 2.

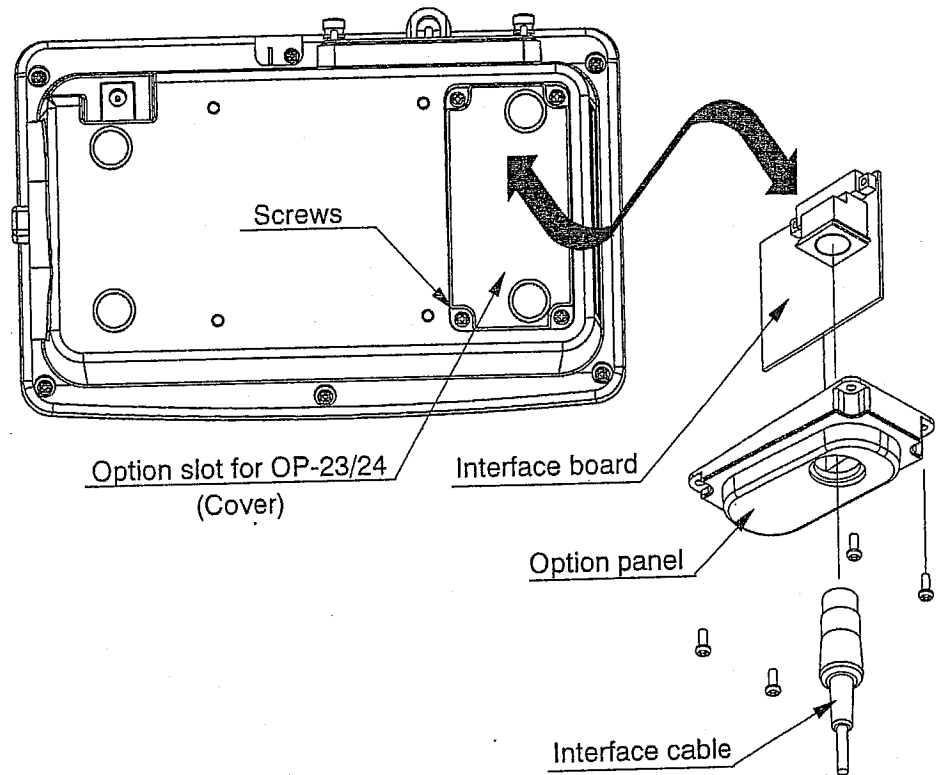

10-2. OP-23 RS-232C serial interface

This interface allows FG series to be connected with a multi-function printer or a personal computer.

- The RS-232C interface has the following four modes.

Stream mode	Outputs data continuously.
Command mode	Controls the scale using commands from a computer.
Print switch mode	Outputs data by pressing the PRINT switch..
Auto-print mode	Outputs data which meets the conditions of auto-print.

- If necessary, set the parameter of the data format and data output mode (F4, F5 and F8).

- A DIN 8 pin connector (JA+TCP0586) is provided with the OP-23 for wiring.

- There are optional cables to connect with a personal computer.

AX-KO577A-200	FG to D-Sub 25 pin computer / RS-232C cable, 2m
AX-KO1786-200	FG to D-Sub 9 pin computer / RS-232C cable, 2m

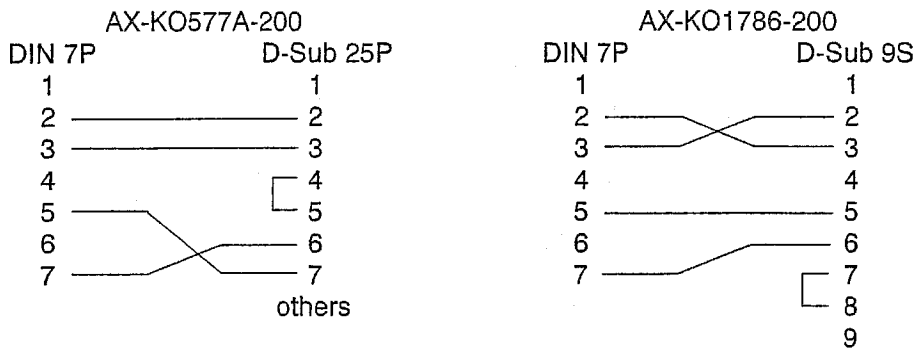

(DIN 7 pin plug P can connect with DIN 8 pin socket.)

Interface specifications

Transmission system	EIA RS-232C
Transmission form	Asynchronous, bi-directional, half-duplex
Data format	Baud rate: 2400, 4800, 9600 bps
	Data: 7 bits + parity 1bit (even)
	Start bit: 1 bit
	Stop bit: 1 bit
	Code: ASCII
	Terminator: $C_{R/LF}$ (C_R : 0Dh, L_F : 0Ah)

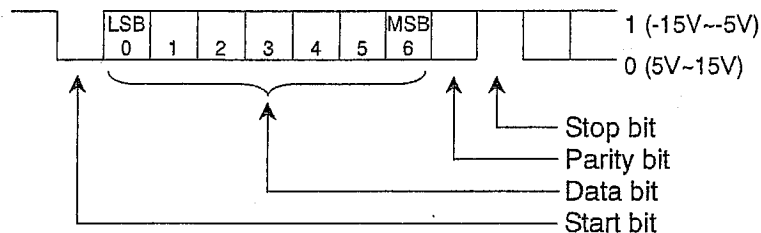

Pin connections

Mating connector:
DIN 8 pin (JA+TCP058)
Attached to FG-23.

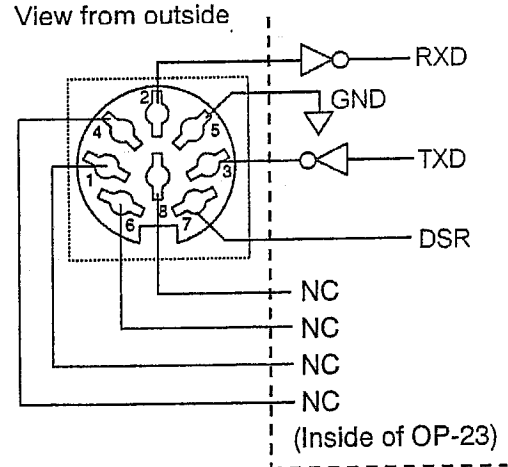

Data format

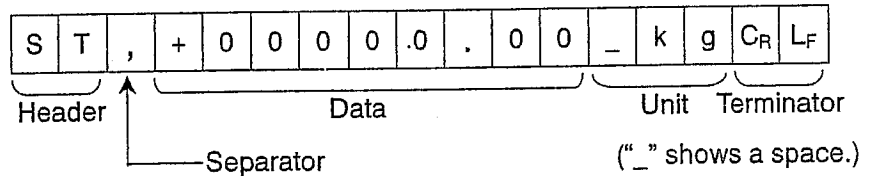

- There are 4 types of headers:
 - ST : Stable weighing data
 - QT : Stable counting data
 - US : Unstable weighing data (including counting data)
 - OL : Out of weighing range (Over)
- The data is normally 9 digits including decimal point and a sign.
- There are 4 types of units:
 - _ k g : Weighing data "gram"
 - _ P C : Counting data "pcs"
 - _ l b : Weighing data "decimal pound"
 - _ o z : Weighing data "decimal ounce"
- The terminator is always C_RL_F.
- Example of output data:

Weighing data "kg"	S	T	,	+	0	0	1	2	3	.	4	5	_	k	g	C _R	L _F
Counting data	Q	T	,	+	0	0	0	1	2	3	4	5	_	P	C	C _R	L _F
Out of range "kg" (+)	O	L	,	+	9	9	9	9	9	.	9	9	_	k	g	C _R	L _F
Out of range "pcs" (-)	O	L	,	-	9	9	9	9	9	9	9	9	_	P	C	C _R	L _F

Data output mode

Stream mode Function setting "F5-0"

The scale outputs the current display data. The data-update rate is approximately 10 times per second. This rate is the same as the display-update.
The scale does not output data while it is in setting mode.

Print switch mode Function setting "F5-2"

When the **PRINT** switch is pressed while the weighing data is stable (STABLE indicator is on), the scale transmits the data.

Auto-print mode +/- data Function setting "F5-3"

The scale transmits the weighing data when the display is stable (STABLE indicator is on) and the data is more than +4d or less than -4d of weight data.

d = minimum weight display (see "12-1 Specifications")

When in counting mode, "d" is equal to minimum weight display of kg mode.

The next output can be obtained after the display returns to between -4d and +4d.

Auto-print mode + data Function setting "F5-4"

The scale transmits the weighing data when the display is stable (STABLE indicator is on) and the data is more than +4d of weight data.

d = minimum weight display (see "12-1 Specifications")

When in counting mode, "d" is equal to minimum weight display of kg mode.

The next output can be obtained after the display returns to below +4d.

Command mode Function setting "F5-1"

In the command mode, the scale is controlled by commands that come from the personal computer and so on.

Command list

"Q" command Command to request the current weighing data.

Command **Q** **C_R** **L_F**

Reply **S** **T** , **+** **0** **0** **1** **2** **3** . **4** **5** **_** **k** **g** **C_R** **L_F**

"Z" command Same operation as the **RE-ZERO** or **ZERO** switch.

Command **Z** **C_R** **L_F**

This command works as **RE-ZERO** for the metric models
and as **ZERO** for U.S.A. models.

"T" command Same operation as the **TARE** switch.

Command **T** **C_R** **L_F**

This command works as **TARE** for U.S.A. models.

The metric models cannot accept this command.

Reply to the command

When the "F8-0" is selected, the scale reacts to the received command as follows.

- For the "Q" command, the scale will send the data.
- For the "Z" and "T" commands, the scale will send the same code as a reply after executing the command.

Reply

Z	C _R	L _F
---	----------------	----------------

Reply

T	C _R	L _F
---	----------------	----------------

When the command cannot execute because the scale is unstable, for example "I" will be sent.

Reply

I	C _R	L _F
---	----------------	----------------

- If the received command is not for the FG series, the scale will send "?". The " command for the metric model is included to this group.

Reply

?	C _R	L _F
---	----------------	----------------

- When "F8-1" is selected, there is no reply except the "Q" command.

10-3. OP-24 RS-232C serial interface and Comparator relay output

The OP-24 has an RS-232C series interface and relay output for the comparison function. It allows output of the HI, OK or LO signal results to an external device as a solid state relay output.

See The specification for the RS-232C interface is same as the OP-23 (FG-23).
 "10-2. OP-23 RS-232C serial interface" for further information.

Interface specifications

Pin connections

Mating connector:
 DIN 8 pin (JA+TCP058)
 Attached to FG-24.

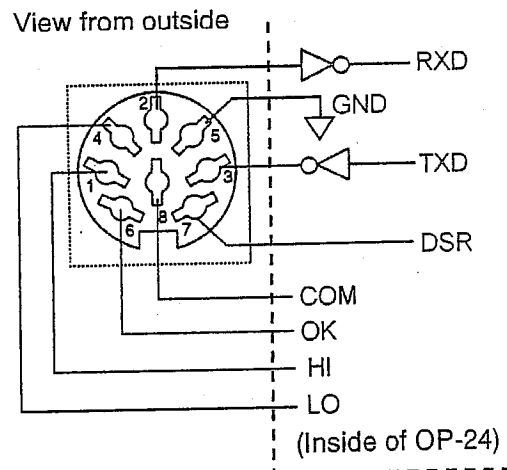

Maximum rating for relay is as follows.

- Maximum voltage: 50V DC
- Maximum current: 100mA DC
- Maximum ON resistance: 35?

11. MAINTENANCE

11-1. Notes on maintenance

- Do not disassemble the scale. Contact your local A&D dealer if your scale needs service or repair.
- Please use the original packaging for transportation.
- Do not use organic solvents to clean the scale. Use a warm lint free cloth dampened with a mild detergent.

11-2 Error codes

Overload error

E

Warning to indicate that an object beyond the scale capacity has been placed on the pan. Remove the object from the pan.

Range over notice

-E

This will be shown if the weight sensor receives strong force upward. Check if the weighing pan is touching anything or if there is anything in the base. There is a possibility that the weight sensor itself may have a failure.

Unit weight error

Lo ut

The sample weight is too light to set the unit weight in the counting mode. Increase the sample numbers.

Low battery

Lb0

Warning to show that the batteries are exhausted. Replace them with new batteries.

Low power

Lb1

Warning to show that the voltage of main power source is too low.

Memory writing error

Err 3

This may be shown that the scale fails to store parameters when the calibration, function setting, unit weight registration, comparator limits setting and so on have been done. Turn the power off once and try the above procedure again. If this error happens again, there is a defect in the memory device.

If you cannot cancel an error or other errors occur, request service from the store where you purchased the product or to your A&D dealer.

12. SPECIFICATIONS

12-1. Specifications

MODEL	FG-30KAM FG-30KBM	FG-60KAM FG-60KBM	FG-150KAM FG-150KBM	FG-60KAL	FG-150K
Weight capacity (kg)	30	60	150	60	150
Min. display (kg)	0.01	0.02	0.05	0.02	0.05
	0.005 *	0.01 *	0.02 *	0.01 *	0.02 *
	0.002	0.005	0.01	0.005	0.01
Weight capacity (lb)	60	150	300	150	300
Min. display (lb)	0.02	0.05	0.1	0.05	0.1
	0.01 *	0.02 *	0.05 *	0.02 *	0.05 *
	0.005	0.01	0.02	0.01	0.02
Weight capacity (oz)	960	2400	4800	2400	4800
Min. display (oz)	0.5	1	2	1	2
	0.2 *	0.5 *	1 *	0.5 *	1 *
	0.1	0.2	0.5	0.2	0.5
No. of samples	5 (can be changed to 10, 20, 50 or 100) pieces				
Max. counts	120,000 pcs	96,000 pcs	120,000 pcs	96,000 pcs	120,000
Min. unit weight	0.25 g	0.625 g	1.25 g	0.625 g	1.25g
Repeatability (Std. deviation)	0.005 kg	0.01 kg	0.02 kg	0.01 kg	0.02 kg
Linearity error	±0.01 kg	±0.02 kg	±0.05 kg	±0.02 kg	±0.05
Sensitivity drift	±20 ppm / °C (10°C~30°C / 50°F~86°F)				
Display	7 segment LCD display (Character height 26 mm)				
Display update	10 times per second				
Operating temp.	-10°C~40°C / 14°F~104°F, less than 85% R.H. (non-condensing)				
Power supply	AC adapter or C size (R14P / LR14) x 4 batteries				
Battery operating	Approximately 150 hours with alkaline dry cell battery				
Weighing pan size	300 x 380 mm / 11.8 x 15.0 in.			390 x 530 mm 15.4 x 20.9 in.	
Dimension	FG-KAM: 300(W) x 624(D) x 781(H) mm 11.8(W) x 24.6(D) x 30.7(H) in. FG-KBM: 380(W) x 464(D) x 118(H) mm 15.0(W) x 18.3(D) x 4.6(H) in.			390(W) x 771(D) x 781(H) 15.4(W) x 30.4(D) x 30.7	
Weight (approximately)	FG-KAM: 11.2 kg FG-KBM: 9.7 kg			16.4 kg	
Calibration weight (Factory setting)	30 kg 60 lb	60 kg 150 lb	150 kg 300 lb	60 kg 150 lb	150 300

*) Factory setting

12-2. Dimensions

FG-60KAL
FG-150KAL

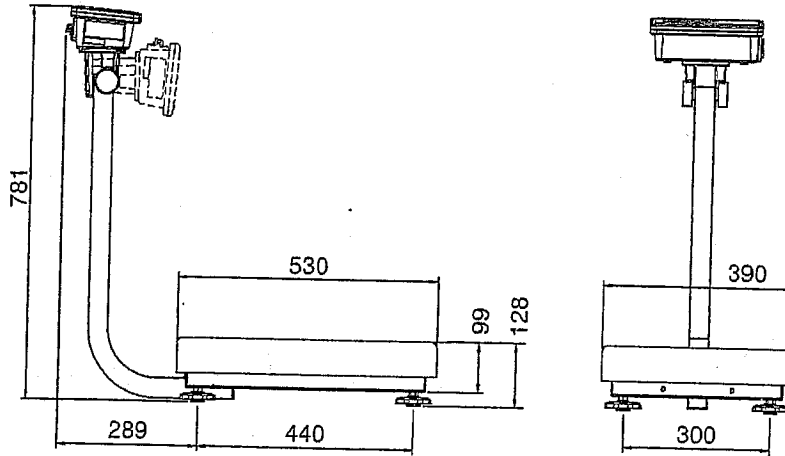

FG-30KAM
FG-60KAM
FG-150KAM

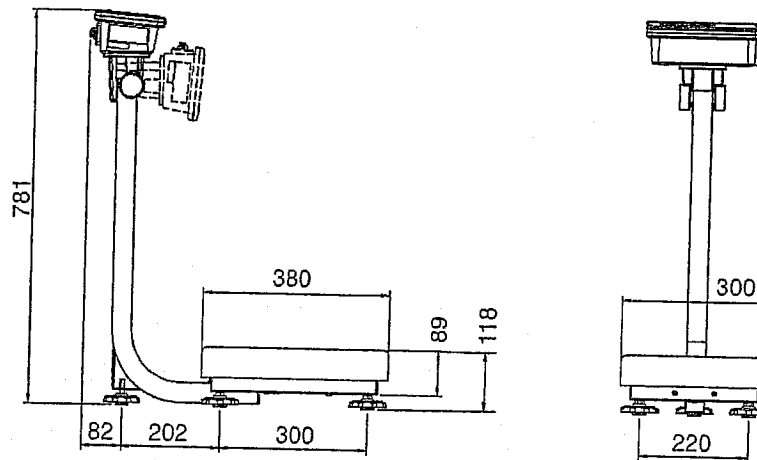

FG-30KBM
FG-60KBM
FG-150KBM

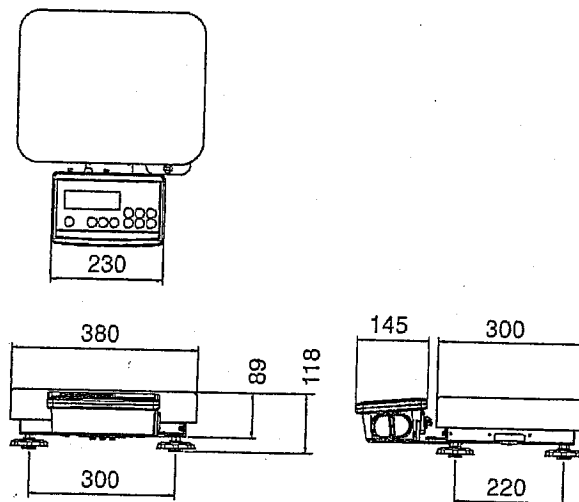

mm

GRAVITY ACCELERATION MAP

Values of gravity at various locations

Amsterdam	9.813 m/s ²	Manila	9.784 m/s ²
Athens	9.807 m/s ²	Melbourne	9.800 m/s ²
Auckland NZ	9.799 m/s ²	Mexico City	9.779 m/s ²
Bangkok	9.783 m/s ²	Milan	9.806 m/s ²
Birmingham	9.813 m/s ²	New York	9.802 m/s ²
Brussels	9.811 m/s ²	Oslo	9.819 m/s ²
Buenos Aires	9.797 m/s ²	Ottawa	9.806 m/s ²
Calcutta	9.788 m/s ²	Paris	9.809 m/s ²
Cape Town	9.796 m/s ²	Rio de Janeiro	9.788 m/s ²
Chicago	9.803 m/s ²	Rome	9.803 m/s ²
Copenhagen	9.815 m/s ²	San Francisco	9.800 m/s ²
Cyprus	9.797 m/s ²	Singapore	9.781 m/s ²
Djakarta	9.781 m/s ²	Stockholm	9.818 m/s ²
Frankfurt	9.810 m/s ²	Sydney	9.797 m/s ²
Glasgow	9.816 m/s ²	Taichung	9.789 m/s ²
Havana	9.788 m/s ²	Taiwan	9.788 m/s ²
Helsinki	9.819 m/s ²	Taipei	9.790 m/s ²
Kuwait	9.793 m/s ²	Tokyo	9.798 m/s ²
Lisbon	9.801 m/s ²	Vancouver, BC	9.809 m/s ²
London (Greenwich)	9.812 m/s ²	Washington DC	9.801 m/s ²
Los Angeles	9.796 m/s ²	Wellington NZ	9.803 m/s ²
Madrid	9.800 m/s ²	Zurich	9.807 m/s ²

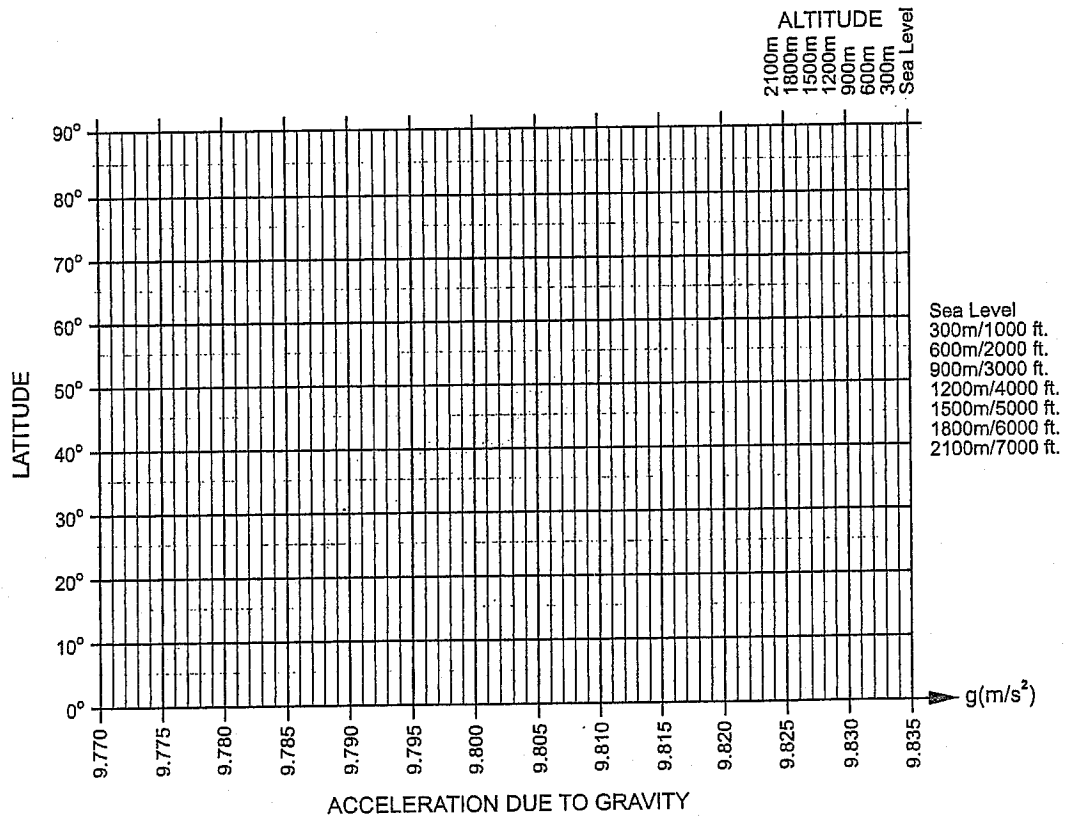

World map

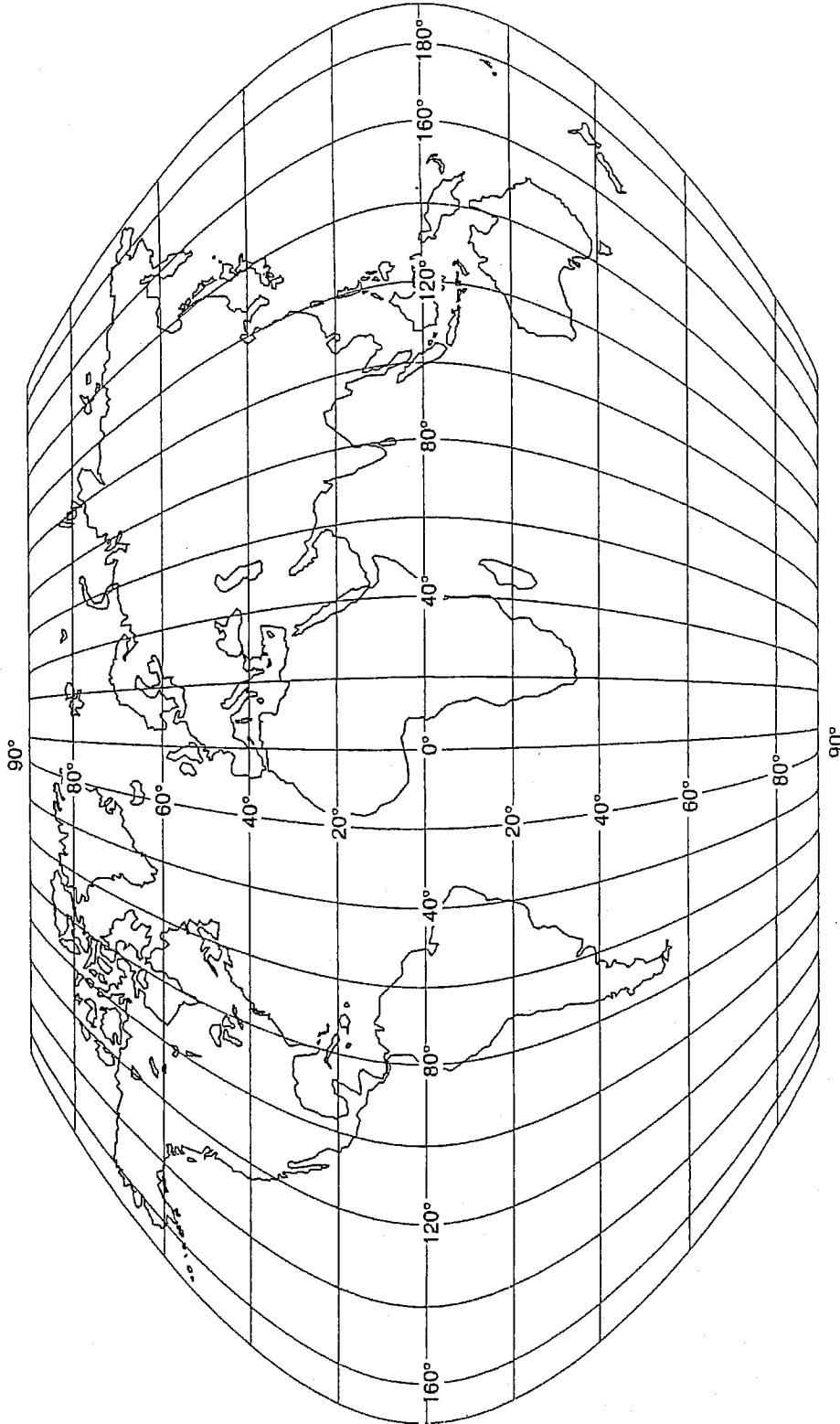

- 1
- 10 ft.
- 10 ft.
- 10 ft.
- 100 ft.
- 100 ft.
- 100 ft.
- 100 ft.

5²)